



Republic of Zimbabwe

COORDINATED AGRICULTURAL AND RURAL DEVELOPMENT

CORD

village water supplies

IMPLEMENTATION MANUAL

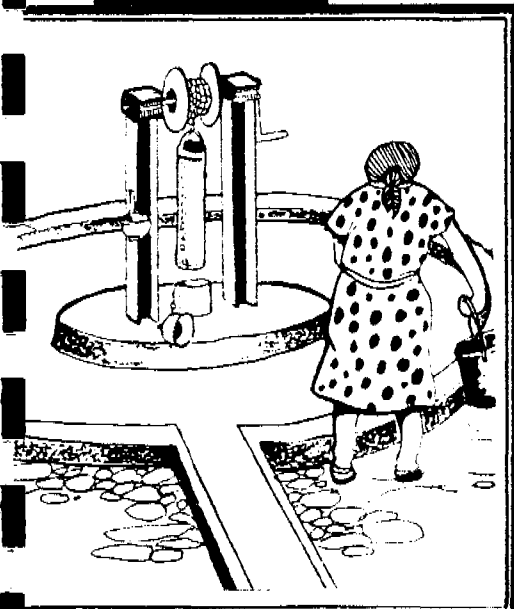

Agricultural and Rural
Development Authority /
Provincial Planning Unit
PO Box 357, Masvingo
Zimbabwe



Deutsche Gesellschaft für
Technische Zusammenarbeit
(GTZ) GmbH

Postfach 5180
Dag-Hammarskjöld-Weg 1+2
D 6236 Eschborn/Ts 1

submitted by
Provincial and
District
Project Team

205.1-86VI-18065

Water For All

a handbook for
community-based
workers



LIBRARY IRC
PO Box 93190, 2509 AD THE HAGUE
Tel.: +31 70 30 689 80
Fax: +31 70 35 899 64
BARCODE: 18065
LO:



Water For All

It is the aim of the Zimbabwe Government that every family should have enough clean water for daily needs close to their home.

Where water is plentiful, families are encouraged to use more water for projects such as growing food.

Inside this file you will find useful information about:

- Hygiene and Water
- Community Action in Water Projects
- Siting Village Water Supplies
- Different Methods of Digging and Drilling for Water
- Different Methods of Raising Water.

The file is divided into three sections:

Section One — gives general information about water projects

Section Two — gives extra information about digging and drilling for water

Section Three — gives extra information about raising water.

Extra information provided in Section Two and Three can also be obtained separately in hand-outs and leaflets. These are available from your Ministry of Health offices.

Note carefully!

Some information in this file is still in First Draft. This is clearly marked.



Water For All

section one

general information about
low cost water
development.



Meanings of words and phrases used in this book.

apron — a sloping concrete area built to drain waste water away from a supply.

bed rock — level of rock in the ground.

borehole — narrow hole, drilled through bed rock to deep underground water supplies.

decomposed rock — soft rock commonly found underground.

grout — a mixture of cement which acts as a seal.

hand-blasted well — a well which is blasted through hard rock by licenced blasters.

hand-dug well — wide hole, dug with pick and shovel.

hand-operated drilling rig — also known as a 'Vonder Rig'. A hand-operated machine used to make a tube-well.

licenced blaster — well-digger qualified to use explosives to blast wells.

bucket-pump — A windlass pump which is operated by hand and used to raise water from supplies in villages.

Blair hand pump, Nsimbi pump — These pumps are operated by hand and used to raise water from supplies in villages.

bush pump — a heavy duty lever pump used to raise water from shallow and deep wells.

PVC casing — hardened plastic tubing of a certain measurement.

run-off channel — a narrow concrete drain (10 metres long) which drains water from the apron.

tube-well — narrow hole (170mm wide) drilled down to bed rock, using a hand-operated drilling rig.

water table — level of water in the ground.

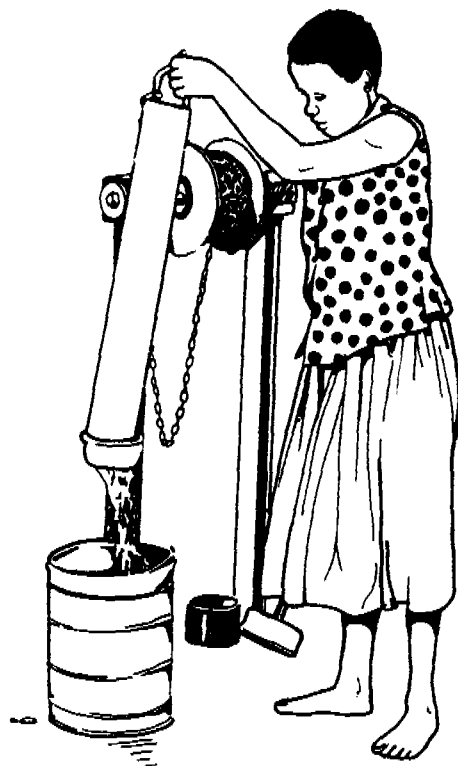

Health and hygiene

Many villages in Zimbabwe still do not have their own water supplies. In these places woman and children have to walk very far to collect water which is then shared by every member of the family. Sometimes there is only enough water for drinking and cooking, and not enough for washing and cleaning the home, or for watering gardens so that people can grow their own food. Health problems such as diarrhoea, sore eyes, skin infections and malnutrition are common in families which do not have enough water near their homes.



It is very important to promote a good understanding in the community about how these health problems occur. In this way groups will become better informed and motivated to take action to improve their traditional supplies. They will also be motivated to join projects to make new supplies. When combined with better hygiene, these efforts will lead to improved health, too!

It is easier to understand and teach others about these problems if we group them in this way:

- group 1: health problems that occur through drinking dirty water.
- group 2: health problems that occur because there is not enough water for hygiene, i.e. in places where water supplies are very limited, or people have to walk too far to collect water.
- group 3: health problems that occur when a person enters infected water.
- group 4: health problems that result from insects which breed in water and carry disease to the people.

Look at the table on the next two pages for more information about these different groups of health problems which are related to water!

Method of spread

Health problems which can occur

GROUP 1

Problems caused by drinking dirty water



Diarrhoea, typhoid, cholera, dysentery, infective hepatitis (jaundice), poliomyelitis.

GROUP 2

Problems that occur because there is not enough water for daily hygiene activities



Diarrhoea, cholera, typhoid and hepatitis.
Skin infections: scabies, septic sores, ringworm and complications which result from these infections.
Eye infections: conjunctivitis, trachoma.
Gut worms: hookworm, tapeworm, roundworm, pinworm.

Types of supplies which cause the problems

- Shallow, unprotected wells
- Rivers
- Dams (unprotected)
- Springs

Ways of preventing the problems

1. Improve existing supplies.
2. Build, protect and maintain new supplies which provide enough water for the needs of their owners.
3. Encourage sanitation projects in the area. Combine such projects with hygiene education.
4. Encourage hygienic practises for water-collection, -storage and -use.
5. Encourage frequent handwashing, plentiful use of water for body and home hygiene (see GROUP 2 also).
6. Boil water (if possible).
7. Treat sufferers.

Limited supplies (eg. shallow wells, waterholes):

- those supplies which are very distant from the home
- those supplies which have very little water
- those supplies which serve many people.

These problems lead to a lack of available water for hygiene and home use, i.e.,

- frequent handwashing
- body washing
- washing of clothes
- washing of cooking utensils
- cleaning the home.

1. Site and build, protect and maintain supplies which can provide enough water for the daily needs and close to the homes of every family which uses them.
2. Combine hygiene education with water-projects and especially encourage:
 - use of more water for body hygiene and other activities in the home
 - frequent handwashing
 - treatment of people in the community who are suffering from health problems.
3. Encourage sanitation projects in the area.
4. Encourage people to maintain their facilities.
5. Treat sufferers.

Method of spread

Health problems which can occur

GROUP 3

Problems caused by infective water



Bilharzia (the infective bilharzia germs grow in snails which live in water that has been polluted by man's excreta.)

NB Bilharzia can be contracted only through water and not from using dirty latrines as many still believe.

GROUP 4

Problems caused by insects which can breed in water.



Malaria, mosquito bites.

Types of supplies which cause the problems

Unprotected supplies in which bilharzia snails breed, eg.:

- Rivers
- Dams
- Streams
- Ponds, lakes, etc.
- Shallow water where vegetation grows easily.

Ways of preventing the problems

1. Encourage use of protected water supplies to avoid contact with infected water.
2. Discourage use of unprotected water supplies for recreation.
3. Promote use of latrines to prevent contamination of water.
4. Spread awareness about bilharzia
5. Clear vegetation near water which can harbour bilharzia snails.

Open water supplies such as shallow pools, swampy areas.

Mosquitoes also breed in water which is lying in old tins, car tyres and in long grass around the home.

1. Protect water supplies close to the home.
2. Drain swampy areas around water-supplies.
3. Clean away places in and around the home where mosquitoes can breed.
4. Encourage limited storage of water where possible, and always in containers.
5. Encourage people to take malaria-tablets required to prevent the disease.
6. Treat people suffering from malaria.

Promote good water hygiene in the community!

Remind the people about these important practices!

Use every opportunity to

- share practical information with groups and individuals about water projects
- help the people to understand about health and other problems which occur through a lack of water
- promote good hygiene practices for water use.



In particular advise families to

- keep special containers for water collection
- clean each container thoroughly before taking water from the supply.



Also advise the people to

- store enough water for family needs for one day only!
- store water in clean, covered containers. This prevents dust, germs and flies from spoiling the water.



It is very important to encourage the plentiful use of water for activities such as

- body washing, especially face, eyes, skin
- handwashing, especially before handling or eating food and after using the latrine
- washing clothes
- washing cooking utensils
- cleaning the home.

wash hands
after using
the latrine

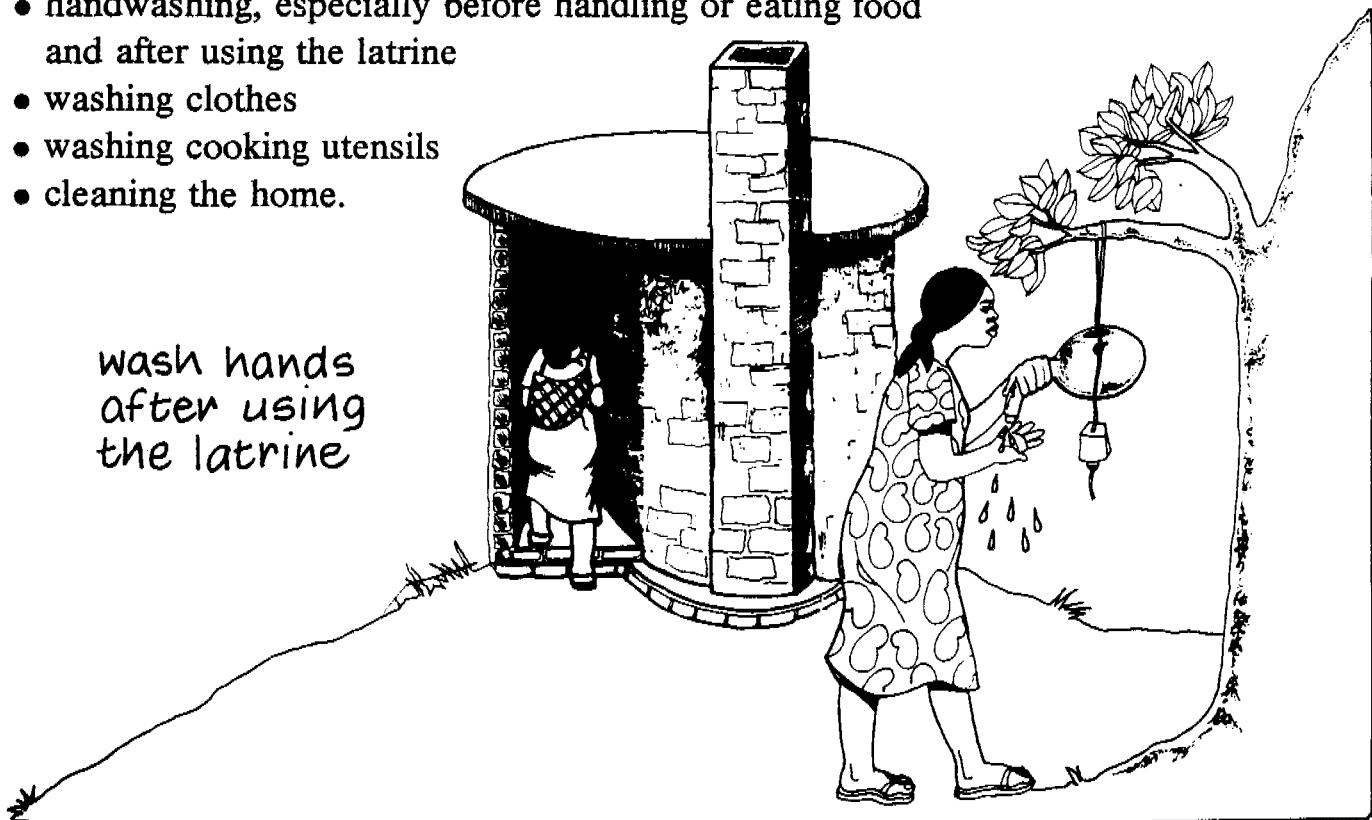

Also:
teach children about the need to use more water for bathing
too!



Community Action For Water



Community action for water!

It would take a long time to achieve the goal of clean water in Zimbabwe through individual effort. Progress will be much quicker if our people can be encouraged by community workers to form groups to discuss their needs for water, and find out about how a project can be started in their area. Through group discussion in the community the people can find out more about:

- their needs for water, i.e. for home use, for crops, for raising animals, etc.
- the kind of supply which is best suited to these needs, i.e., a shallow well, a tube-well, a borehole, etc.
- the number of people in the group who will share the supply
- different methods which can be used for raising water
- what guidance the Community Worker can offer
- the way that labour can be shared during the project and who will maintain the project when completed.



A member of the VIDCO (the Village Development Committee) should be involved in all group discussions about water projects in an area. In this way, programmes for water development can be co-ordinated and properly planned.

All water projects are planned through the VIDCO.



The role of the VIDCO in water development projects

Every village is represented by a community-based worker who belongs also to the Village Development Committee (VIDCO). This person may be a Village Health Worker, for example. The VIDCO co-ordinates projects of all kinds in an area and provides advice and guidance to the people through their representatives. All projects, including water projects, are therefore carefully planned through the VIDCO.

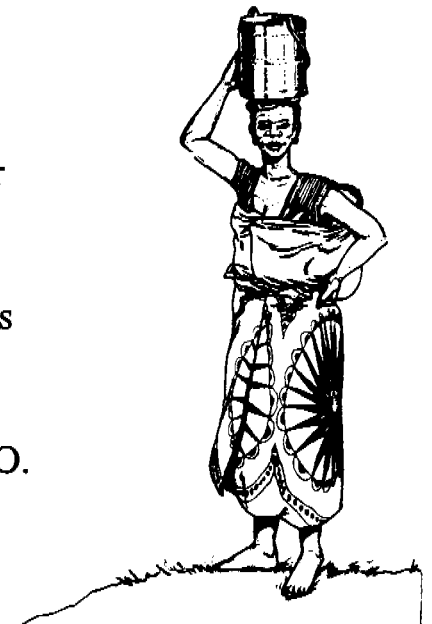

The VIDCO representative will assist the people by

- speaking openly with groups
- listening to problems
- offering guidance and sharing information
- taking group problems to the VIDCO
- keeping groups informed about progress
- encouraging group action in water projects and later in project maintenance
- encouraging involvement in other projects, such as latrine building and growing crops too.



Sometimes the VIDCO Chairman may decide to form a Village Water Supply Committee. This committee is part of the VIDCO, and will be concerned with water projects in an area.

Co-ordinate effort for action!

There are many representatives from different government ministries and helper organizations working at community level. These may be:

- health workers such as Health Assistants, Health Inspectors, Village Health Workers, Medical Assistants and others
- Local Government Promotion Officers, District Councillors
- Community Development workers
- Agritex workers
- traditional authorities and political leaders
- others who work with community groups, such as teachers and literacy workers.



Community-based workers should inform each other of progress through regular discussion. In this way plans can be co-ordinated and community groups will become better informed.



Community-based workers can also

- spread awareness about the need to improve water supplies
- share information about the problems and health hazards caused by insufficient water
- encourage groups to join water projects
- encourage groups to participate in improving traditional water supplies
- demonstrate construction skills
- act as a link between the Government and the people
- co-ordinate water projects through the VIDCO (Village Development Committee)
- promote awareness about the need for improved water hygiene and maintenance
- promote discussion about other matters too, such as agricultural projects and building projects.

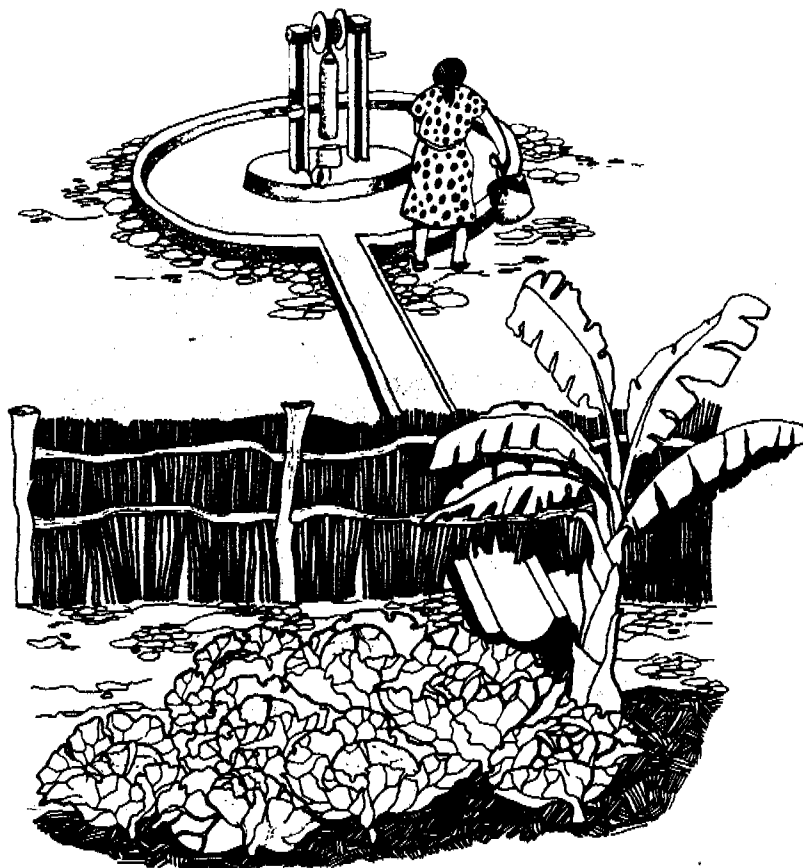



Siting Water Supplies



Understanding about underground water supplies

Much of our rainwater collects in open supplies such as dams, lakes, rivers and swamps. But what happens to the rainwater which does not collect in these places? It soaks into the earth and sinks through many layers of underground soil and soft rock until it reaches bed rock — this rock is hard and prevents it from sinking any further. The water, therefore, spreads sideways to make an underground supply.

Sometimes there are cracks in the bed rock. These cracks allow water to pass through the rock and collect again in supplies much deeper underground.

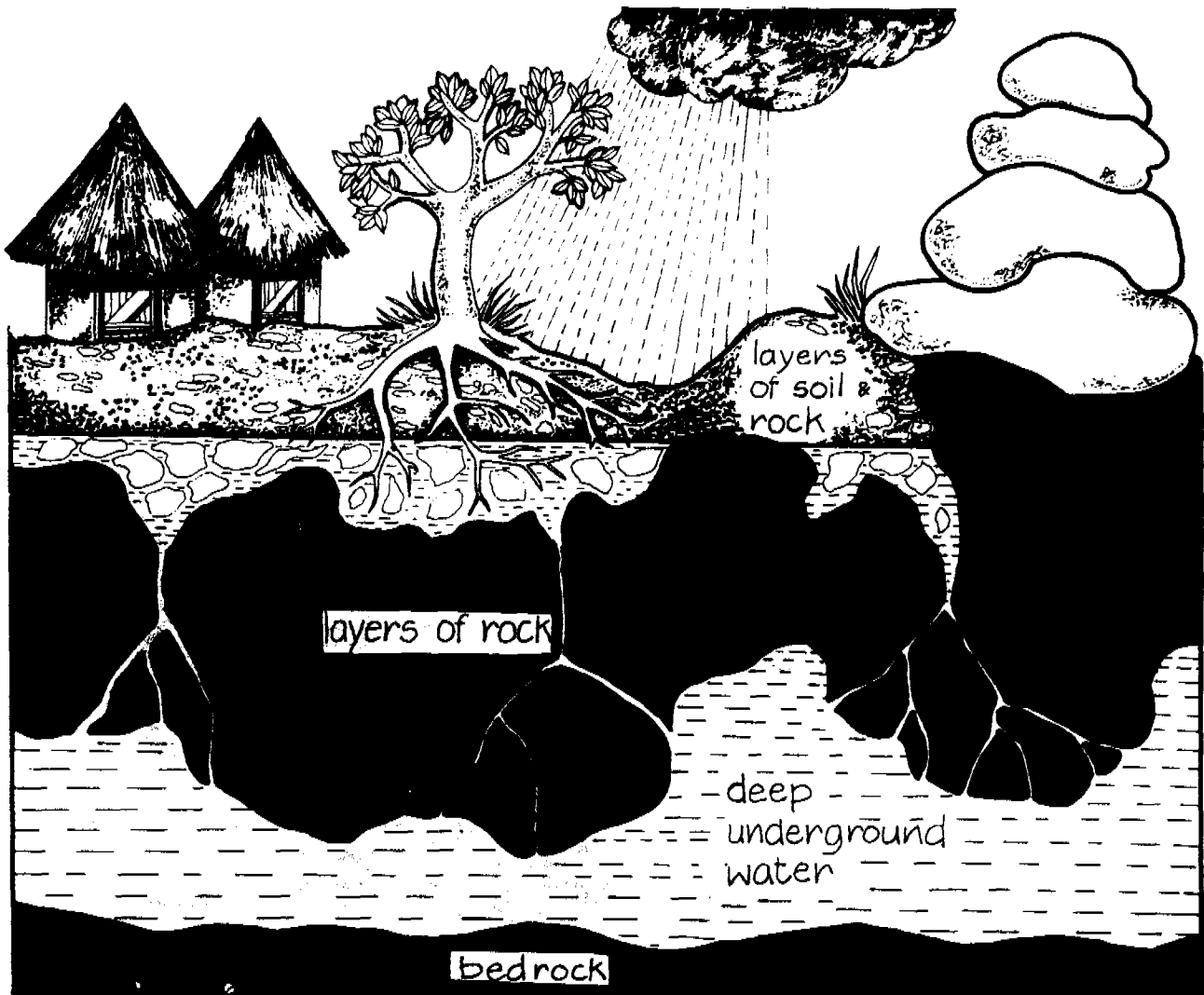

We can reach underground water supplies by digging wells or drilling holes with special machines. These wells are then lined and protected from pollution. A pump or a simple windlass is then fitted to raise the underground water to the surface. It is very important to choose a project site that will provide a good supply of underground water and benefit all the people in the group.

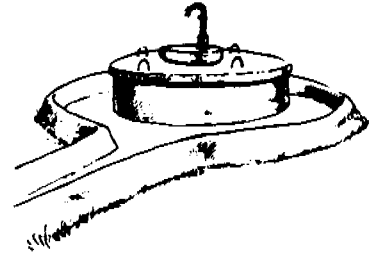

A good project site benefits all the people in the group.



Siting village water supplies

Decisions to site village water supplies are not made individually. They are made by project groups who are assisted by community-based workers.

The best decisions are those which are reached by a group which is made up of

- people who will use the supply
- a community worker who represents the VIDCO
- others, such as traditional people who have special skills to find water.



Water engineers, who specialize in seeking underground water supplies, will also assist the community to reach decisions about siting a village water supply if there is a problem.



A good site for village water supply is

- convenient for all people who share the supply
- at least 30 metres uphill from or to one side of the latrines
- away from cattle kraals and refuse pits
- accessible at all times of the year
- has water in sufficient quantities for the needs of the users
- in an area where the water does not contain salt.

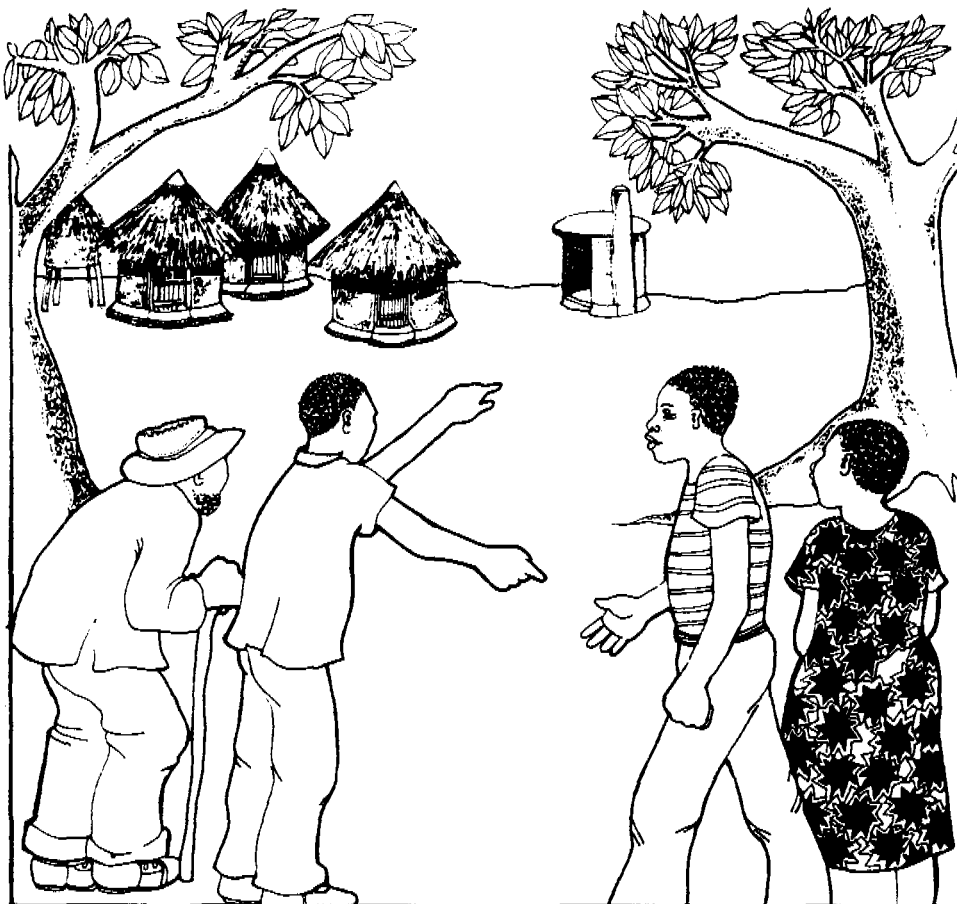

Group decisions to site water are best

Using natural signs to seek underground water supplies

These natural signs may also guide us to find good water supplies:

- places where water has been taken traditionally in the past, eg., wells and springs
- certain vegetation which grows in wet places
- certain trees, such as the muonde tree, the muchakata (umkuna) tree and the mukute tree, which are known to grow in places where there is good underground water
- certain grasses such as those which stay green throughout the year and grow in wet places
- rocks and sandy soils
- anthills
- natural valleys which are surrounded by hills.



Talk also to traditional people who like to use a steel wire or a soft green stick to seek underground water supplies.

When the site has been chosen, the group will decide about the method they will use to reach the underground water supply.

Digging or Drilling for Underground Water Supplies



Different ways of reaching water

Before a water project is started in the community, the group should decide about the method that will be used to reach underground water. This can be done in different ways.

The methods described below are commonly used by project workers in rural Zimbabwe. Use this information as a guide when choosing a method for reaching an underground water supply.



method	advantages of the method	disadvantages of the method
<p>hand-dug shallow wells</p>	<ul style="list-style-type: none"> ● provides water close to the home ● affordable for people in rural areas ● traditionally acceptable ● provides natural water storage ● materials for lining usually available in the community ● groups can share the supply ● water can be raised by windlass or simple hand pump ● can be deepened and improved and easily protected ● groups can share cost of skills and labour 	<ul style="list-style-type: none"> ● may not provide enough water for group needs ● may dry up in the dry season ● may collapse if not properly lined ● source of disease if not properly protected ● provides limited amounts of water (i.e. not suitable for large-scale agricultural projects).

<p>tube-well</p>	<ul style="list-style-type: none"> ● provides water close to the home ● affordable ● tube-well can be fitted with a simple hand-pump ● hygienic, easily protected ● drilled by the community using a locally available hand-operated rig 	<ul style="list-style-type: none"> ● may dry up if not deep enough ● water supply in tube-wells usually limited for needs of individuals and small groups
<p>hand-blasted well</p>	<ul style="list-style-type: none"> ● usually deeper than hand-dug wells ● water supply may be greater than hand-dug well ● can be fitted with a range of hand pumps, but more usually a lever pump, i.e. a Bush pump 	<ul style="list-style-type: none"> ● needs licensed blaster and skilled well-diggers to make the well ● may provide limited water or dry up
<p>borehole</p>	<ul style="list-style-type: none"> ● hole is very deep, usually reaches deep underground supplies ● more water is available for domestic and project use 	<ul style="list-style-type: none"> ● costly ● borehole drilling rig operated by experts only ● available to fewer communities ● limited community participation ● not always in a place that is convenient for the user group



For further information about hand-dug wells, ask for our book called "Well Digging"

Raising Water

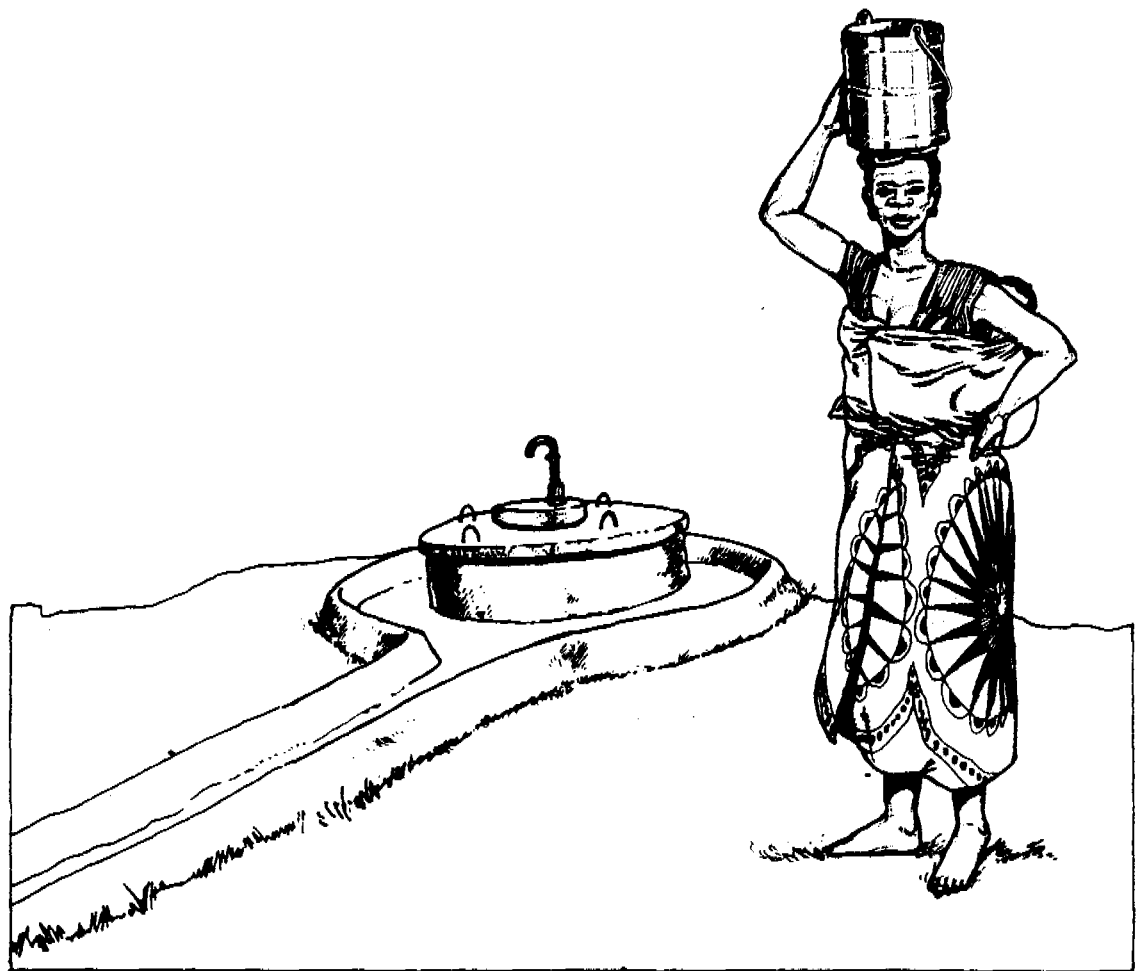

Different methods for raising water

It is important to encourage groups to adopt hygienic methods of raising water from their underground supply. This can be done by fitting a windlass, a hand pump (such as a Blair pump) or a lever pump (such as a bush pump).

When combined with good hygiene and improved practices for collecting and storing water, the advantages of these methods are that

- more water can be hygienically raised from the supply
- the quality of the water improves because the supply is properly protected before the windlass or pump is fitted
- water can be raised more quickly from the supply.

Community-based workers can assist project groups to decide about the best method of raising water from their supply. Their choice will depend on

- the needs of the group
- the depth of the water supply
- the number of people using the supply
- the rate at which the pump can raise water
- the preference of the group for a certain kind of pump.

Other things, such as cost, how groups can assist with the project, and how the pump should be maintained will also be discussed.

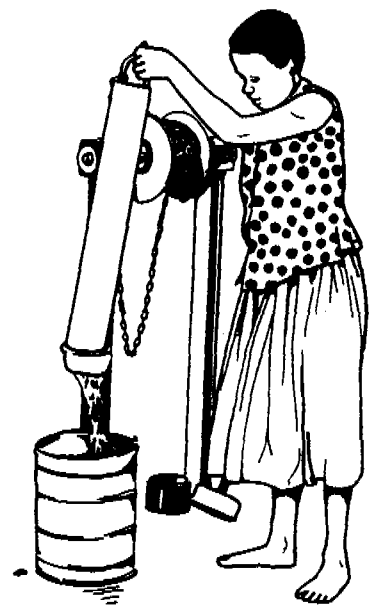

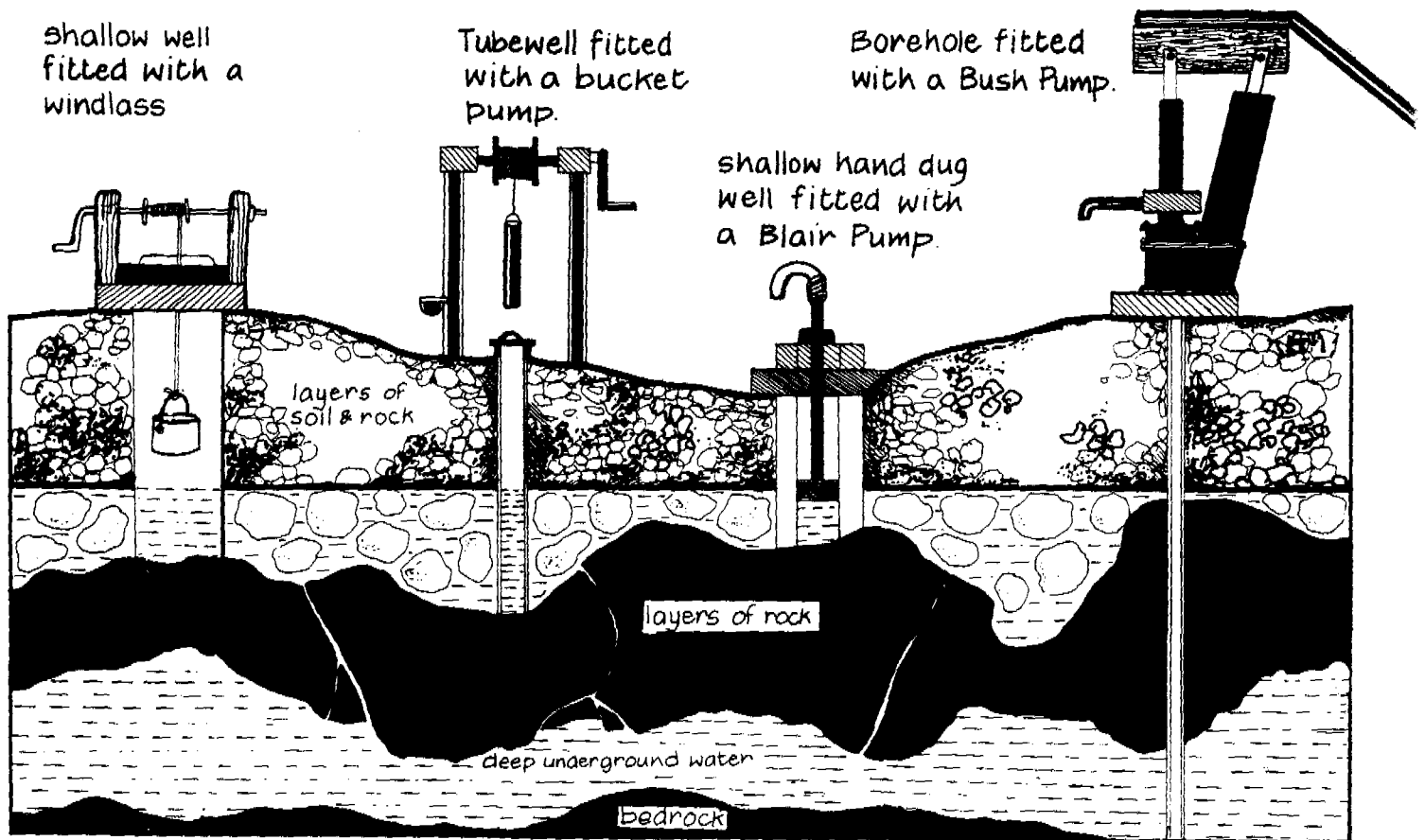

Look at the Table. It gives suggestions about the kind of pump which can be used to raise the water from underground supplies.

kind of water supply	suggested method of raising water
Tube-wells or shallow hand-dug wells (i.e. around 12-15 metres deep)	Use a windlass or bucket pump, a suction pump or a direct action hand pump, i.e. a Blair pump or an Nsimbi pump. Use also a lever pump, i.e. a bush pump
Wells of over 15 metres deep	Use a Bucket pump or a heavy duty lever pump
Boreholes	Use a heavy duty pump

For further information about fitting and maintaining these different pumps, read our numbered Pump Handouts.

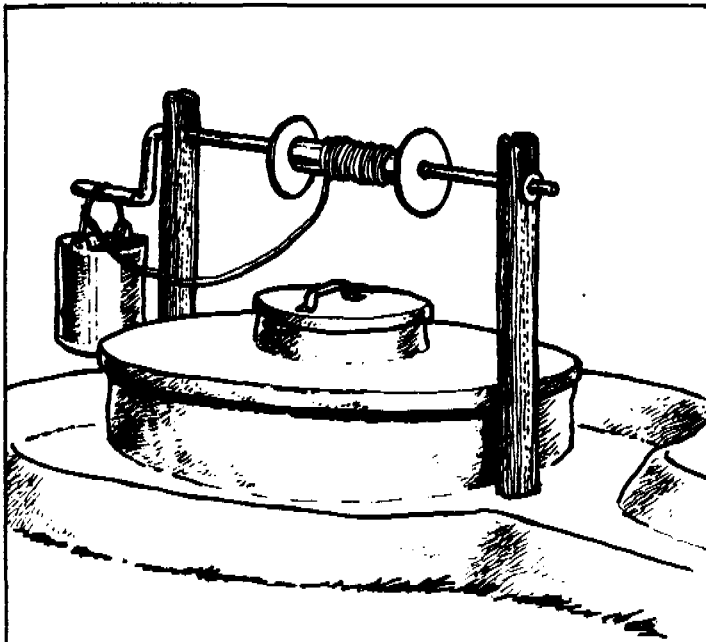

A windlass

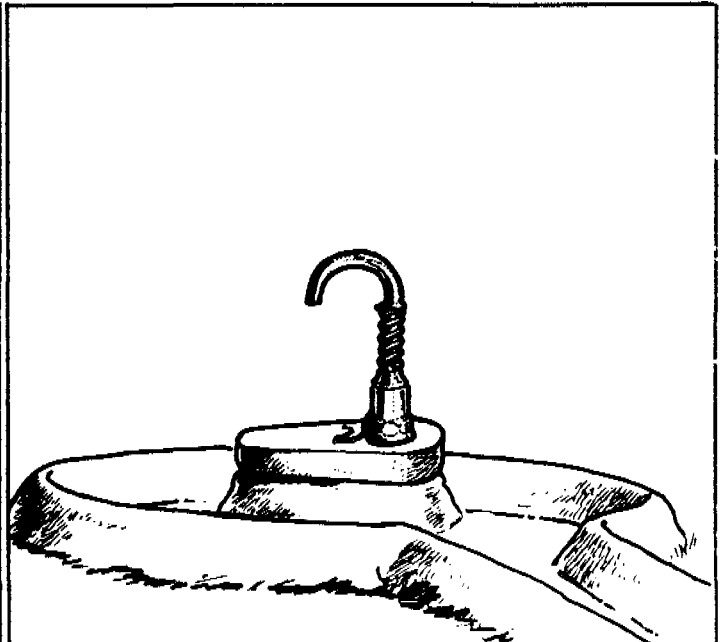

A Zimbabwe Blair Handpump

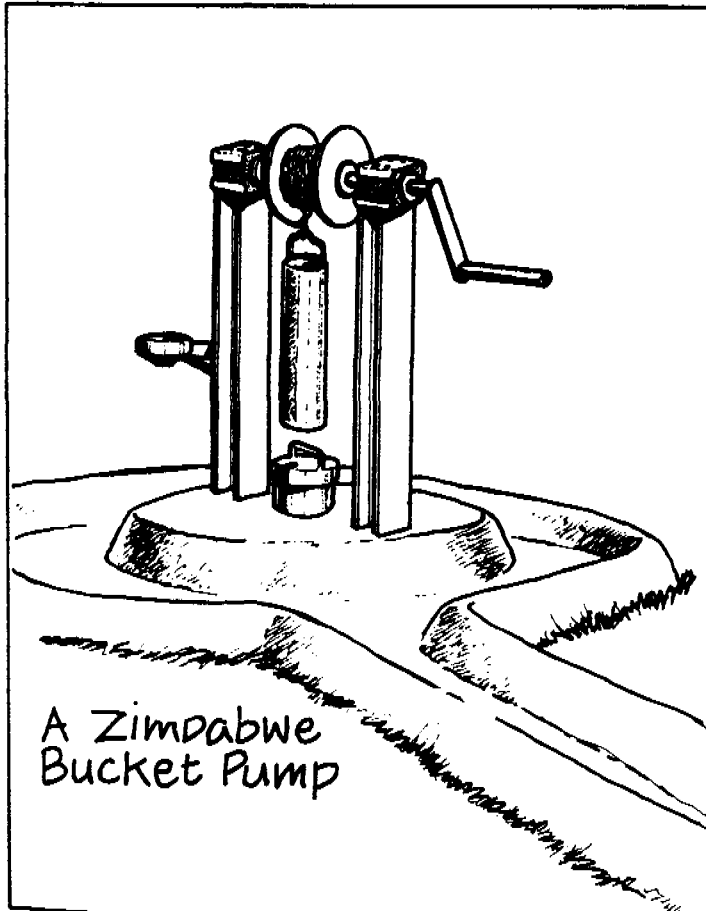

A Zimbabwe Bucket Pump

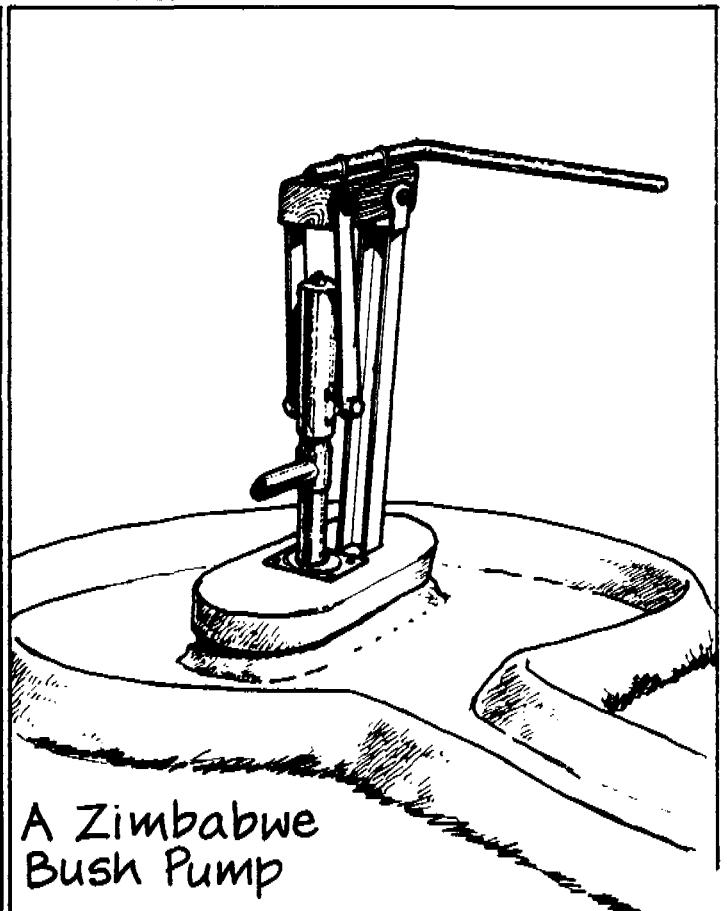

A Zimbabwe Bush Pump

Complete the project! Build a drainage area around the supply!

It is very important to build a concrete drainage area around the water supply. This helps to drain waste water away and makes the area easier to clean.

The drainage area should have

- a 3 metre diameter sloping concrete apron around the pump or windlass
- a 10 metre run-off channel which drains waste water from the apron to a watering place for animals or a group-owned garden.

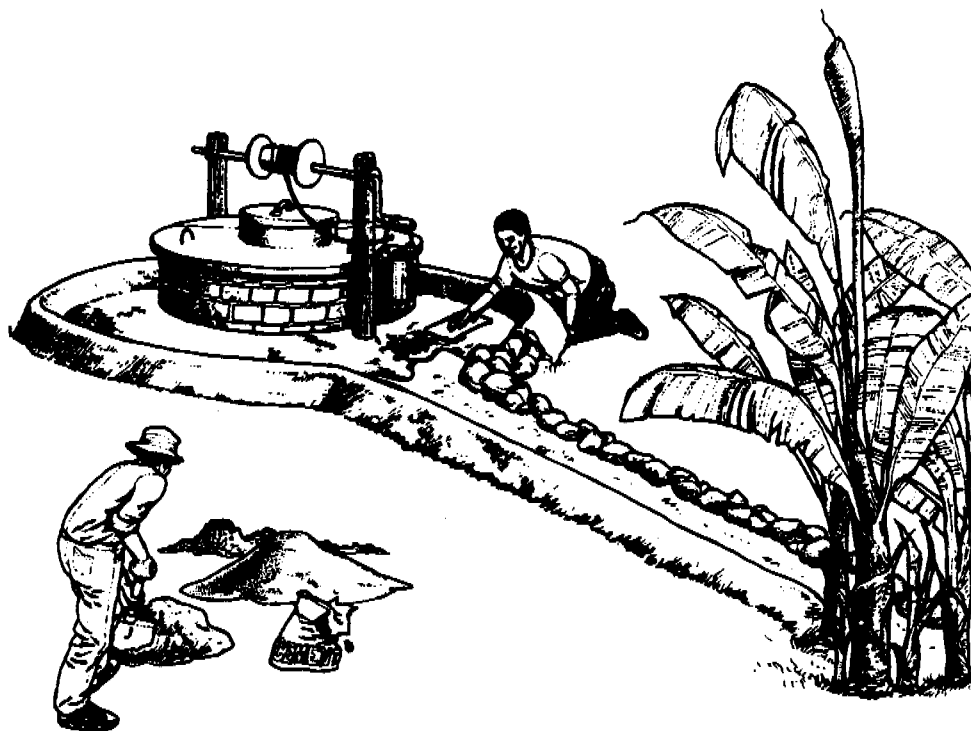

Encourage maintenance too!

Encourage groups to take pride in their water supplies

- to maintain the windlass or pumps regularly
- to report problems immediately, i.e. if the water becomes less or the pump breaks down and cannot be maintained
- to build fences around supplies where possible
- to build washing slabs where possible
- to encourage children to understand the benefits of these improvements
- to practise good hygiene for the collection and storage of water for home-use
- and to use more water for their daily needs.



Water For All

section two

extra information about
digging and drilling for
water.

- digging a well*
- drilling for water using
a hand-operated drilling rig

*draft information



The Hand-Operated Drilling Rig

The Vonder Rig is a hand-operated drilling rig. It is made in Zimbabwe. In many communities throughout the country, groups are using this machine to drill for water.



The Vonder Rig is easy to operate and if it is maintained carefully it can be used again and again. It is used to drill a narrow (170mm) hole which is called a TUBEWELL. Providing there is no hard rock, the Rig can drill through layers of soil until underground water and soil rock is reached. The Vonder Rig is then moved to another site and with the assistance of health workers, the tubewell is lined with class 6 PVC casing (which is hardened plastic piping of a certain thickness and size). Depending on depth and quantity of water a simple handpump is fitted and a drainage area built. In a short time the people have clean water!



In the next few pages, we describe how to position and use a Hand-Operated Drilling Rig. Follow the steps carefully and this will be an easy task. If possible, watch to see how others in the community operate the Vonder Rig!

Water For All

Step by Step Instructions
for using a
Hand Operated Drilling Rig

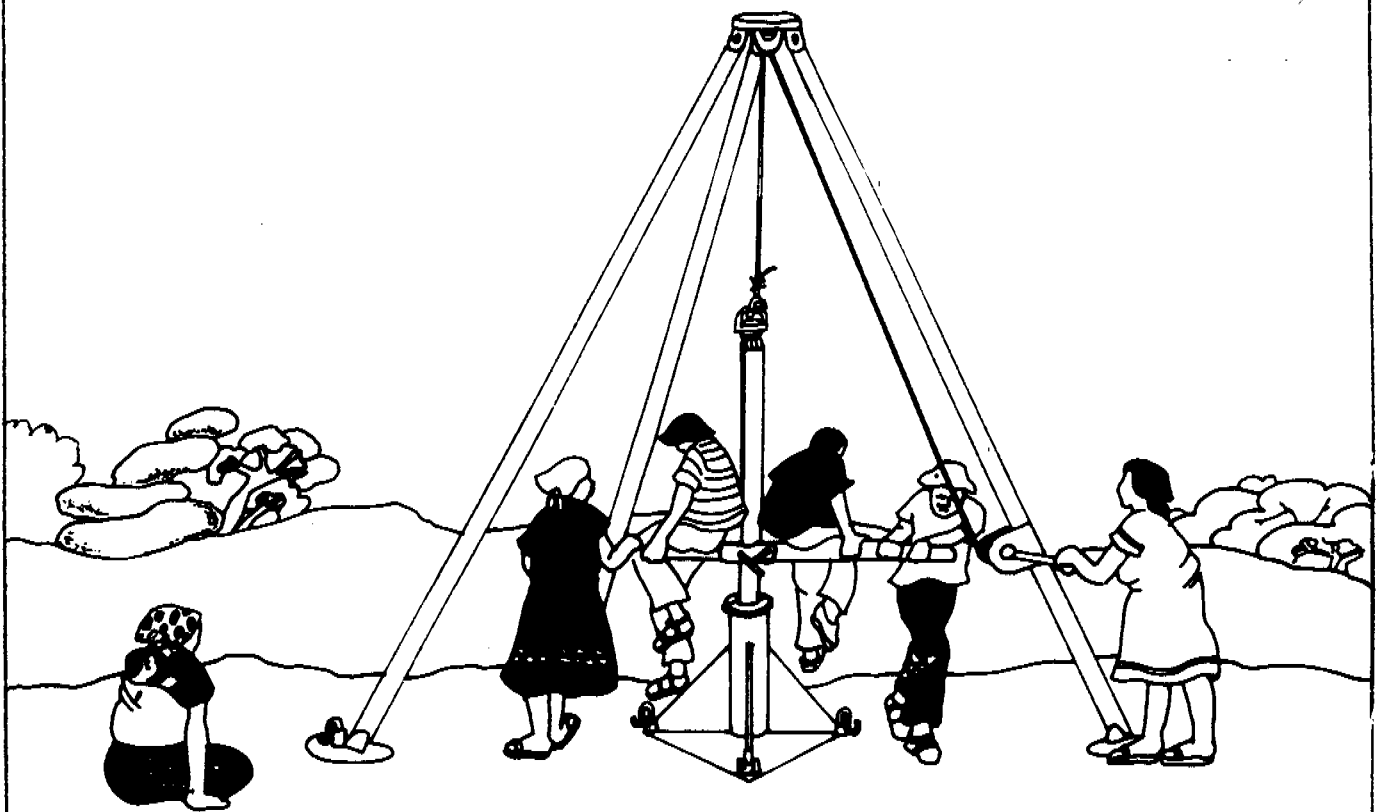

Advantages of a hand-operated drilling rig

It can be operated by groups in the community with the assistance of a trained operator.

It can easily be moved from place to place in the community

It can be used to drill for water at all times of the year.

It can be assembled quickly.

It requires less effort than digging a well

If water is not reached the first time, the drilling rig can be moved to another site which has been chosen by groups who will use the water supply.

There are disadvantages too!

The Hand-Operated Drilling Rig cannot be used to drill through hard rock! In places where there is deep underground rock, other methods are being used to reach water. For example, well diggers with blasting licences can be employed by the community to deepen existing wells or blast new wells. Borehole machines are also used for drilling through hard rock to underground water.

In places where the soils are sandy or wet, difficulty may be experienced with using the Hand-Operated Drilling Rig. The tubewell is also difficult to line under these conditions because the soil collapses easily.

a hand-operated drilling rig

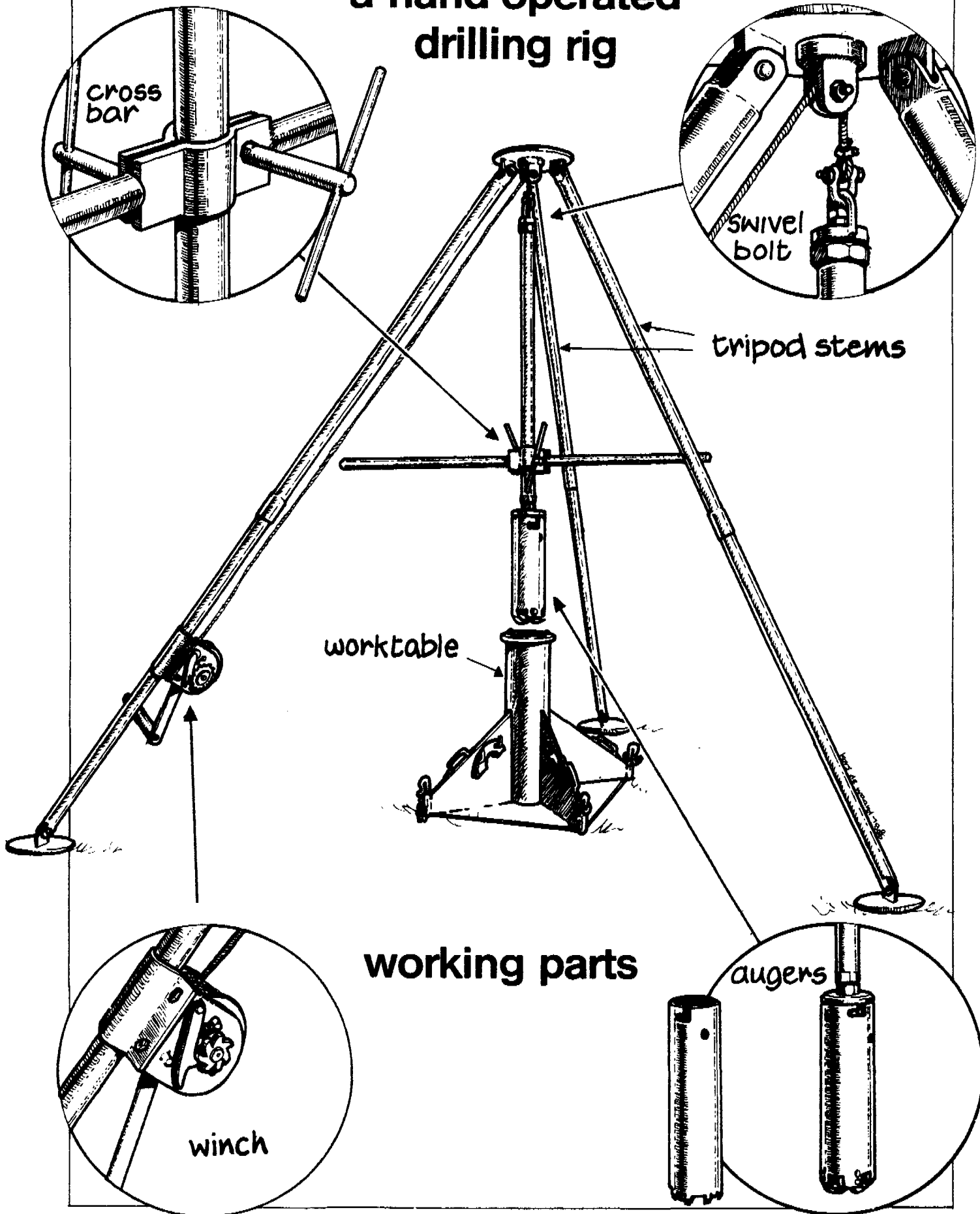

① The Hand-Operated Drilling Rig is set up at a site chosen by the community.

To do this

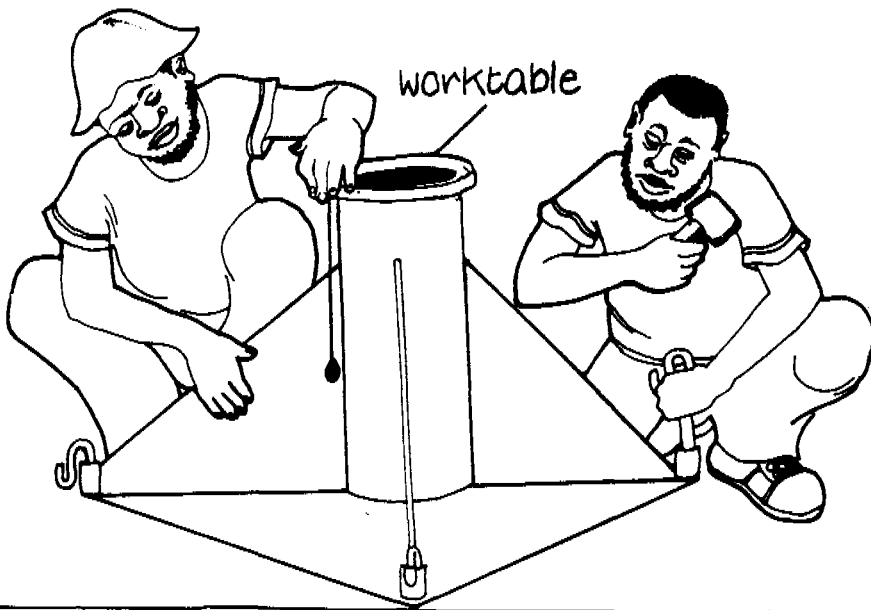

- Position the Work Table.
- Level the Work Table on the ground.
- Use the Plumb line to do this.

② Thread the cable through the cable pulley.

- screw the tripod legs together
- Position the tripod accurately over the centre of the Work Table.

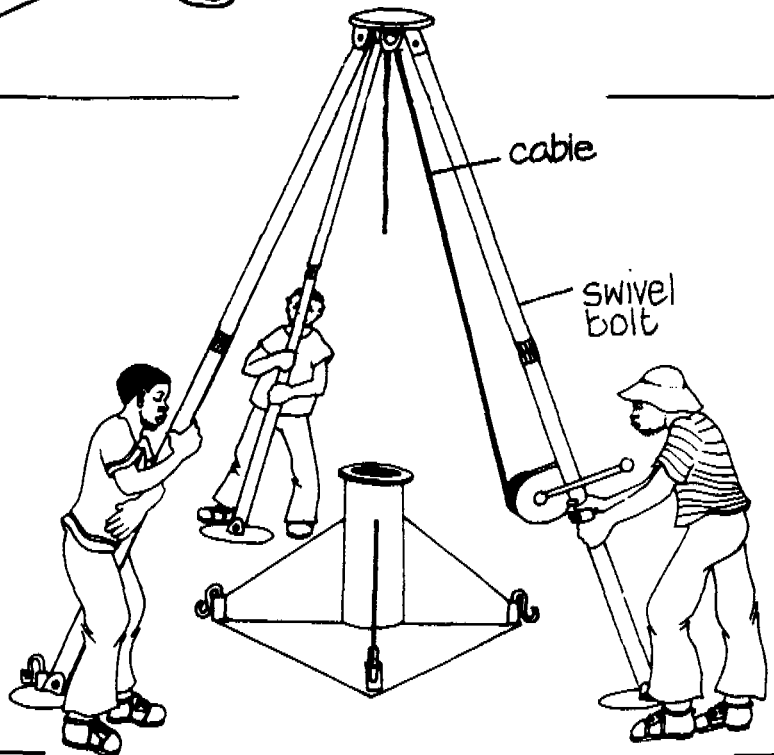

③

swivel bolt

- Lower the cable with the winch.
- Attach swivel bolt to cable.
- Lower swivel bolt into worktable to test position.

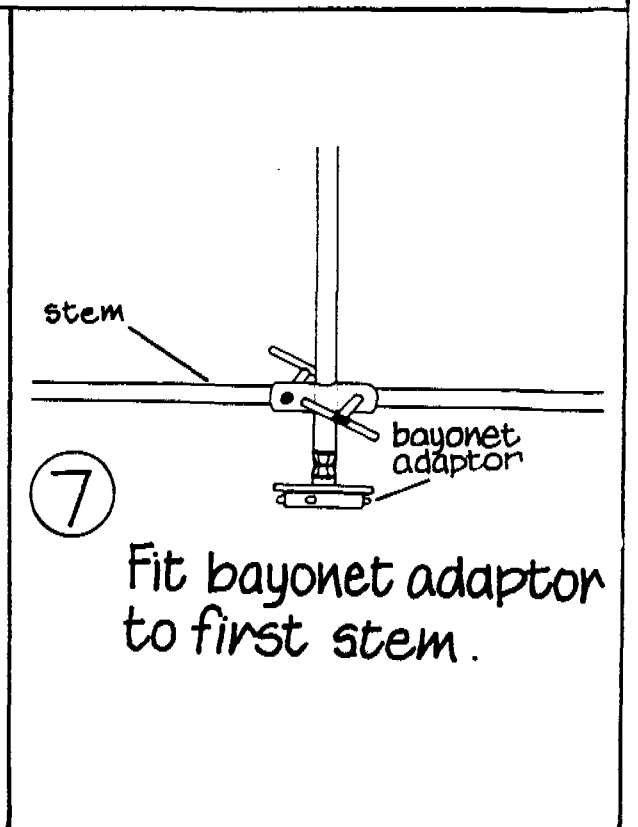
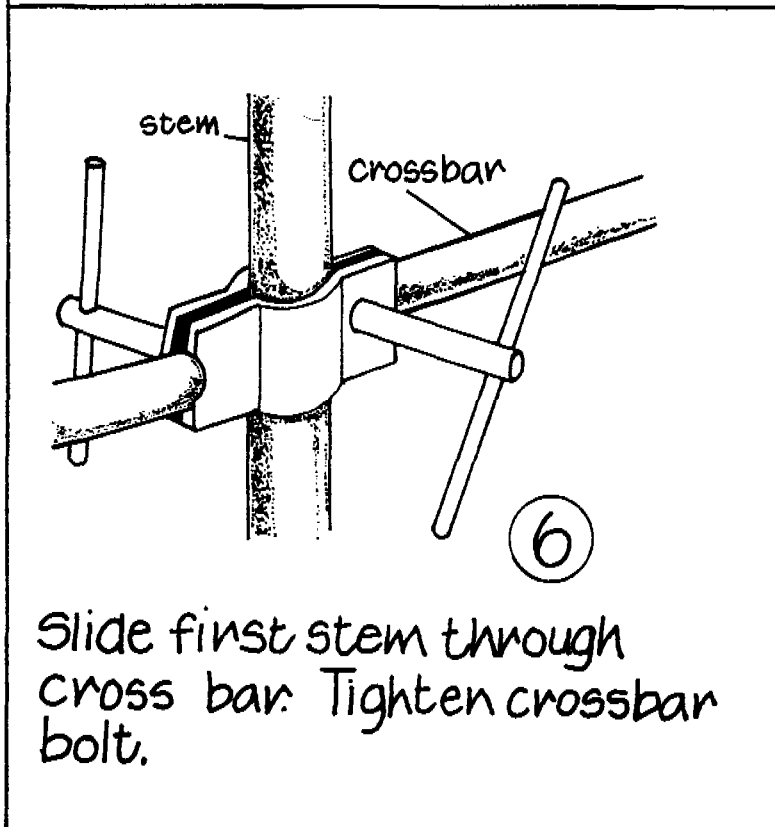
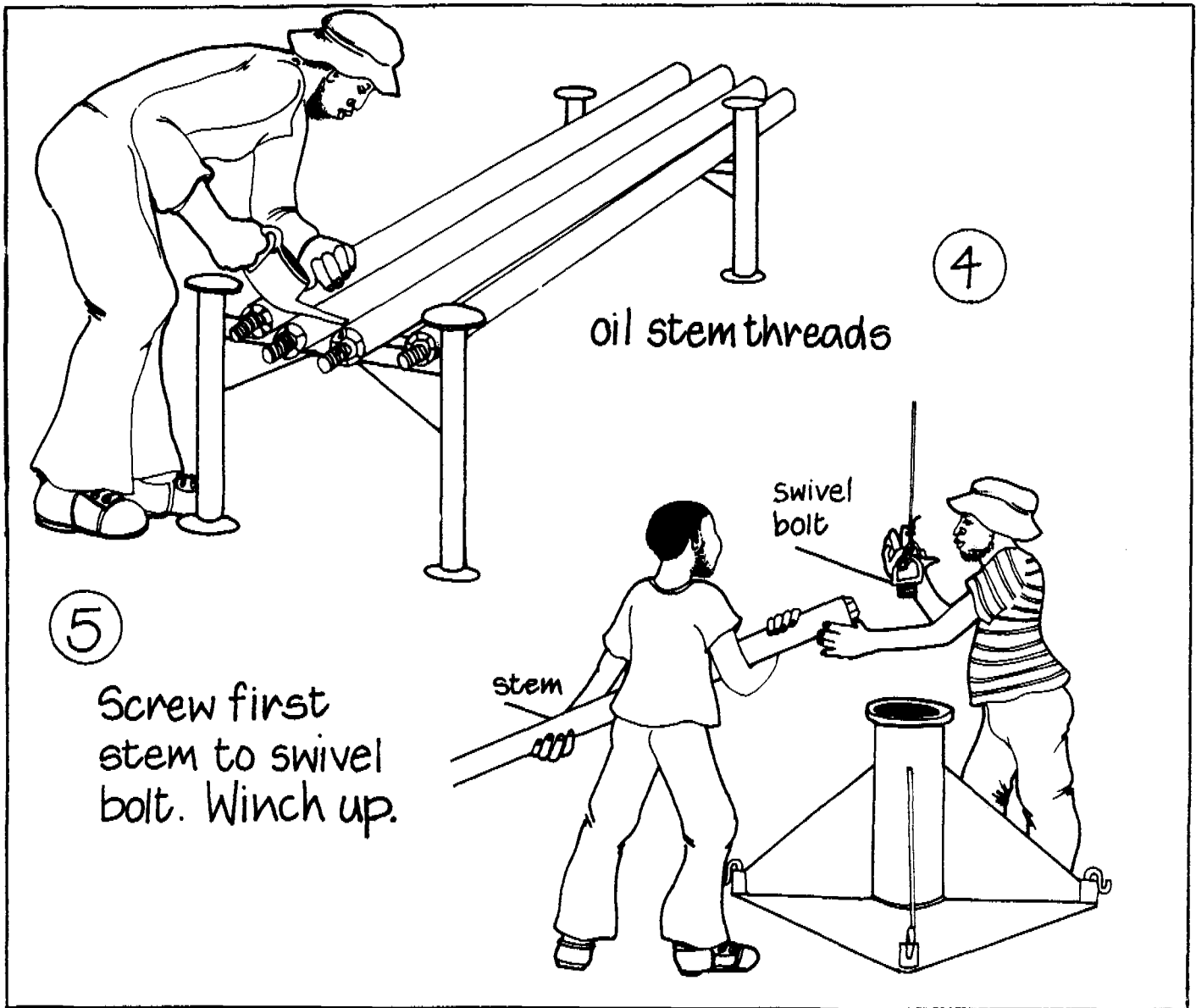

8

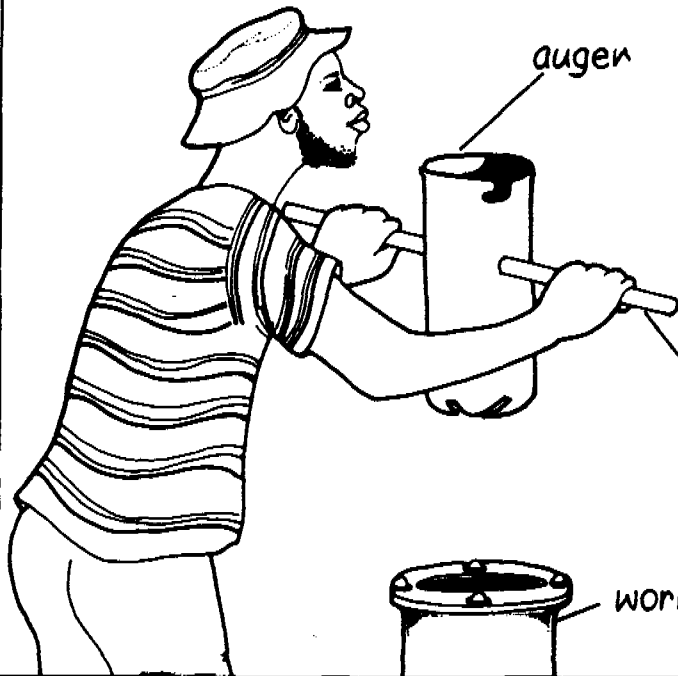

auger

Insert Auger bar through standard auger. Position auger in Worktable.

auger bar

worktable

9

Connect bayonet adaptor to standard auger.

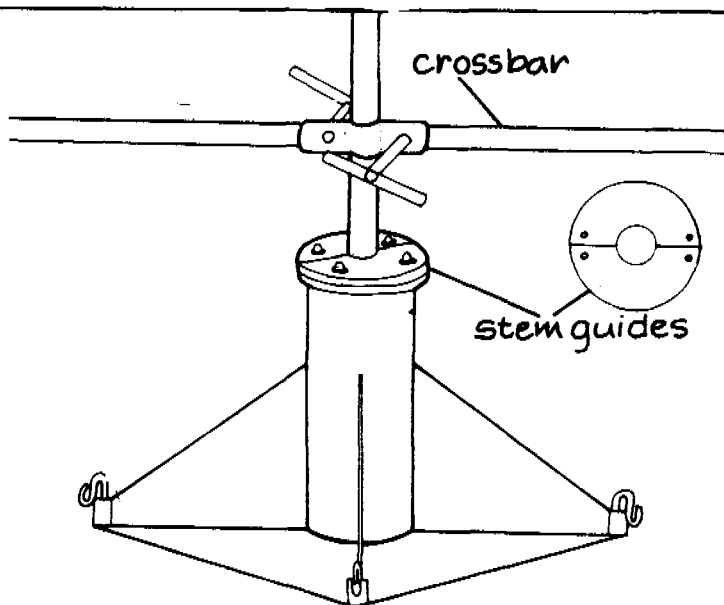
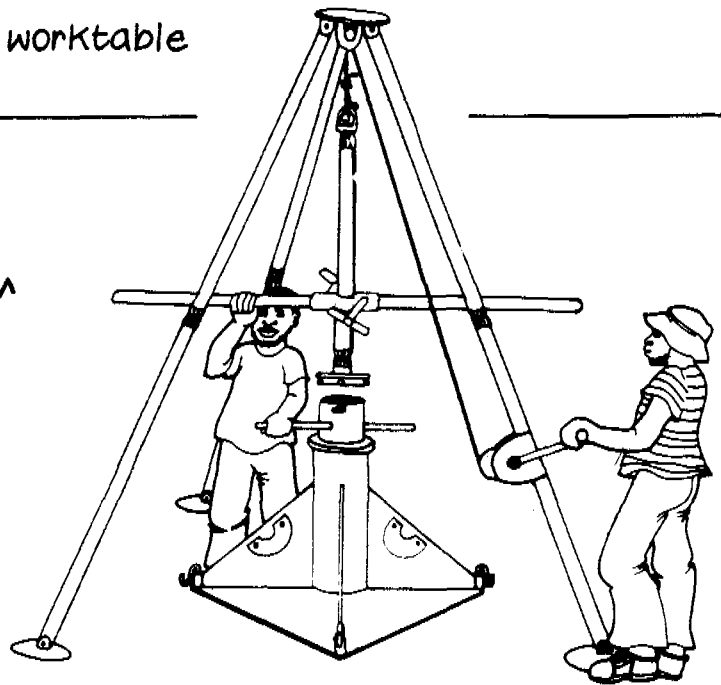

crossbar

stem guides

10

Fit stem guides around the stem.

Lower crossbar to convenient position.
Tighten crossbar bolts.
Push crossbar in clockwise direction.
Commence drilling operation

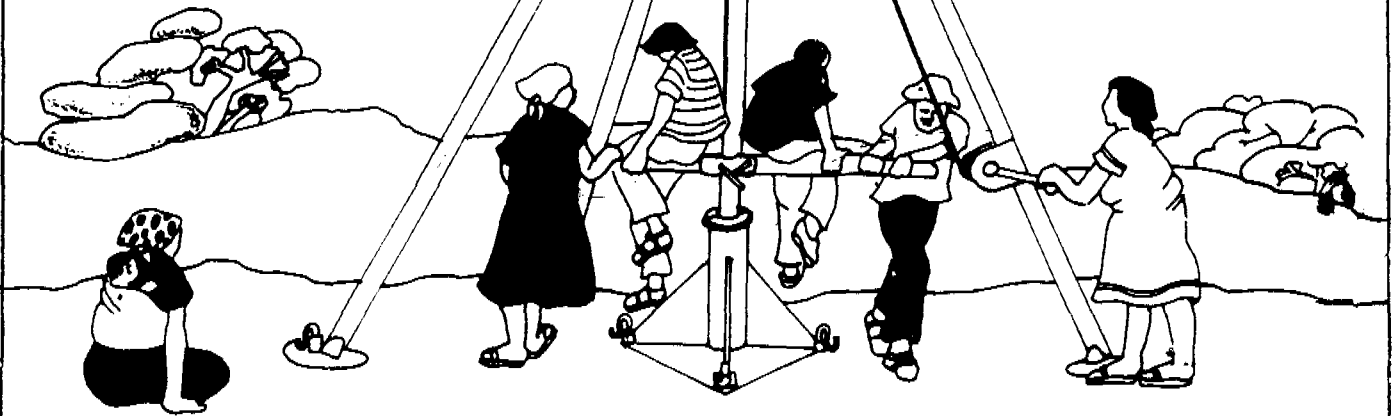

Seat helps on crossbar to add extra weight if necessary.

When auger stops going down, it is probably full.
To remove auger:

Remove stem guides after last stem is raised. Hang on worktable hook
Winch up auger.
Insert auger bar.
Disconnect auger from bayonet adaptor
Remove auger from worktable.

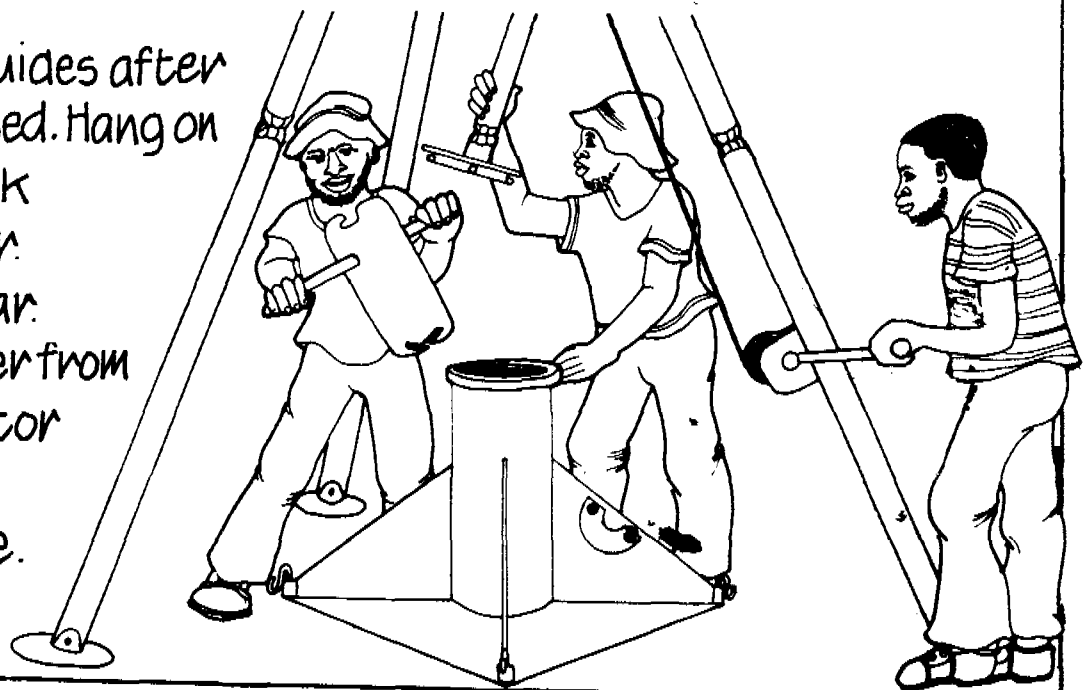



13

Remove soil from auger

As hole deepens connect extra stems to first stem. Proceed with drilling as from step 7 until hard rock is reached.

14

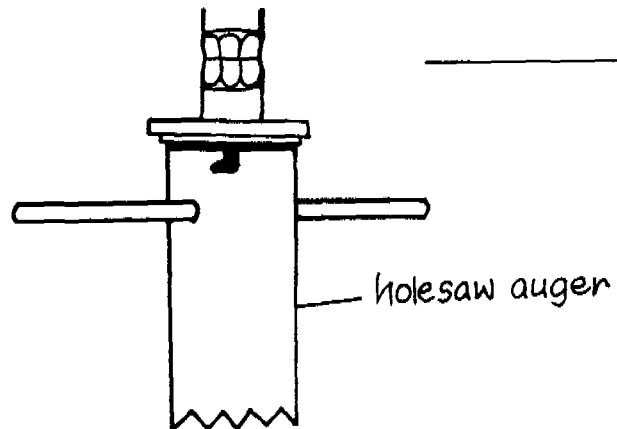

Use Holesaw Auger for drilling in decomposed rock! Attach as for standard Auger. See step 7.

When hard rock and at least 3 m of water is reached in the tubewell, the rig can be removed to another drilling site. Then a decision is made about the kind of pump to be fitted. This depends on the depth of the Tubewell

15

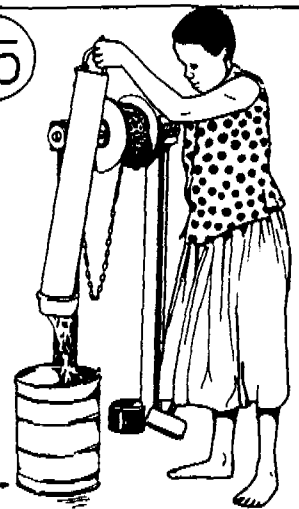

the quantity of water available
 how many people will use the supply
 in shallow wells i.e. 12m, use a Blair/Bucket Pump.
 in tubewells of between 12-22m use a Bucket/Pump
 in tubewells of over 22m use a Bush Pump.
 Class 6 PVC casing is used to line the tubewell.
 Then the Pump is fitted, a drainage area is built,
 and the people have clean water!

Water For All

well digging

a guide to the
construction
and protection of
hand-dug wells.

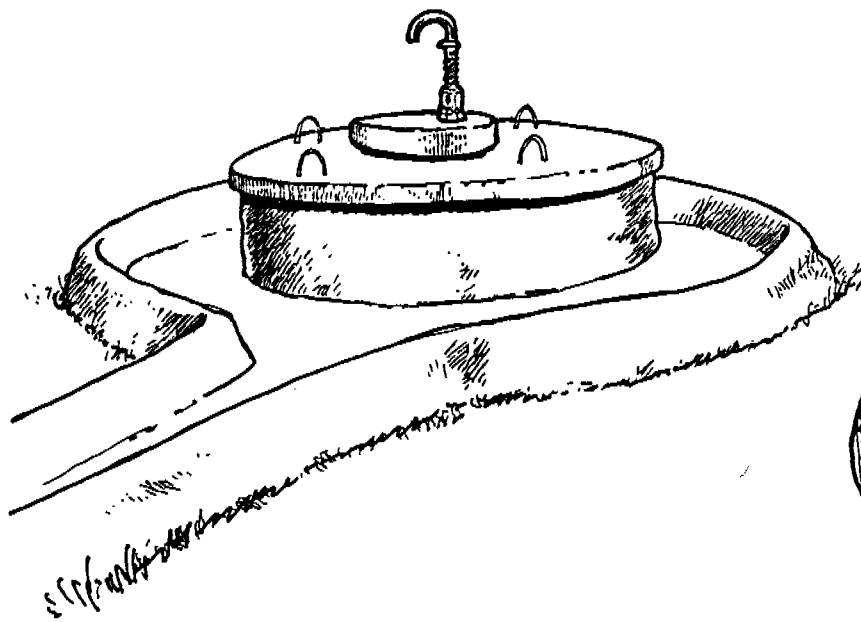

First draft



Well digging

**A guide to the construction
and protection of hand-dug wells**

Acknowledgements

This book is written in non-technical language. It describes how to dig and protect a well. It also describes how to improve and upgrade a traditional well.

Many people have assisted the author by providing valuable information for the book. In particular, mention should be made of the Public Health Inspectorate of the Ministry of Health, the staff of Blair Research Laboratory, non-Governmental organisations, and the teams of health and other workers who strive so hard to improve water supplies throughout Zimbabwe.

To the Health Education Unit of the Ministry of Health and many others not specifically mentioned, but who have so willingly supported this work - our thanks.

Finally, to GTZ, who have generously funded the development of this book, - our appreciation.

Sue Laver

Our book is about well digging.

It tells us how to

- * join a well digging project
- * dig a shallow well
- * protect a shallow well
- * improve a traditional well

Our book also describes what the community can do to maintain the well and use it hygienically after it has been completed.

Wells provide an important source of water to our people

Promote well digging at community level!

At this time in rural Zimbabwe, thousands of families depend on wells for their daily water supplies. Many of these wells are constructed by groups working together in the community. Others are built by their individual owners or experienced well diggers.



Water is essential to development and our Government supports the people's efforts to provide water to their families in this way. In promoting well digging at community level we should also promote methods of well protection, and help people to understand water hygiene too.

In this way water will come to be valued by our people as an asset to good health and development at community level.



We can promote well digging for these reasons.

- * Wells can be constructed close to the home
- * People in the rural areas of Zimbabwe can afford to build wells
- * Wells are traditionally acceptable to the people of Zimbabwe
- * Wells provide a place for natural water storage
- * Most materials needed for well digging are available in the community
- * There are skilled well diggers in many communities so there is no need to call outside experts
- * Well digging is a group activity
- * The quality of water in traditional wells can be improved and maintained by protection, good hygiene and careful maintenance



There can be disadvantages too.

- * Some wells provide inadequate supplies of water because they are too shallow
 - * Shallow wells may dry up quickly after the rains
 - * Many wells are sources of hidden disease and danger because they are polluted
 - * Uncovered, unprotected wells are dangerous
- 

It is important to combine education with well digging.

Why is it that some families who take their daily water supplies from wells commonly suffer from sicknesses such as diarrhoea and other health problems? These problems occur because their family water supply is polluted with disease-carrying germs. Sometimes the wells are far away from the homes. Sometimes they are shallow. When problems like these exist, the people do not collect enough water to use for daily hygiene activities. Then health problems such as sore eyes, skin infections and malnutrition occur. If the people do not collect enough water for growing food, then malnutrition may occur. Health problems also arise when people are careless about how they collect and store the water from their wells.

It is just as important to tell people about the causes of health problems as it is to tell them about good ways of digging wells. The people must understand the need

- * to protect a well so that waste cannot enter the water
- * to maintain the drainage area around the well so it does not become littered with rubbish and mud
- * to fit a windlass or simple pump to raise water hygienically
- * to collect and store water hygienically
- * to provide plenty of water for body hygiene, use in the home and for projects such as growing food
- * to improve sanitation in the community

Project information about well digging

All plans for water development projects in an area must be discussed with the VIDCO. Representatives of the VIDCO will help groups to reach decisions about their water projects. There are also other community-based workers such as Health Inspectors, Village Health Workers, Agritex workers and many more people who can share information about water projects. Groups also need to talk to key leaders and those who have dug traditional wells.

Before starting to dig the well, the project group needs to decide together with the community leaders

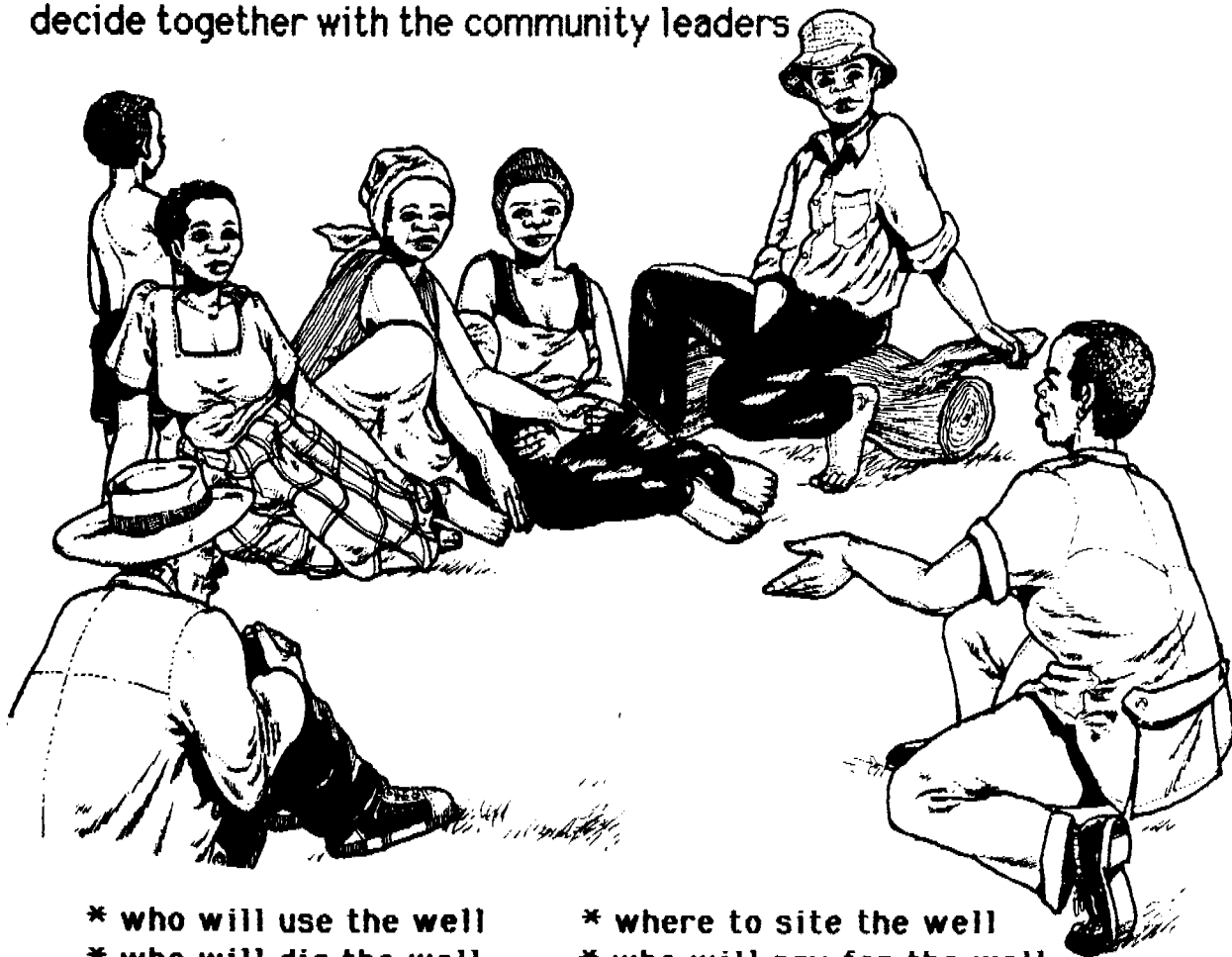

- * who will use the well
- * who will dig the well
- * what materials and tools will be needed for digging the well
- * how the group members will share the tasks
- * how to protect the well
- * how to raise clean water from the well either with a simple windlass or handpump
- * how to make a drainage area around the well
- * how to share the maintenance of the well
- * where to site the well
- * who will pay for the well

If a professional well digger is hired, the group should decide who will be responsible for providing food and shelter.

A well-digger needs materials and tools

Building materials

Cement for

- * lining the well
- * protecting the well
- * building the drainage area

The amount of cement will depend on the depth of the well and the type of lining eg

- * for a 5 m deep well which is lined with stones or burnt bricks, 5-6 bags of cement will be needed.

- * for a well 5 m deep which is lined with concrete rings 13 bags of cement will be needed

Reinforcing wire

- * use 8 gauge reinforcing wire for strengthening the cover slab

Stones

- * large stones for lining the well and
- * small stones for the concrete mix

River sand

- *for the concrete mix

In some parts of the country, steel moulds are available for making concrete well liners. In other places steel shutters are used for this task.

Tools

ladder	trowel	rope	hammer
2 buckets	tape	shovel	string
pick	wooden float	spirit level	steel float
chisel	pliers (for cutting wire)		

A simple windlass can also be made to make the task of raising the rock and soil from inside the well easier as it is dug. Use strong poles, steel wire, a pulley and a bucket.

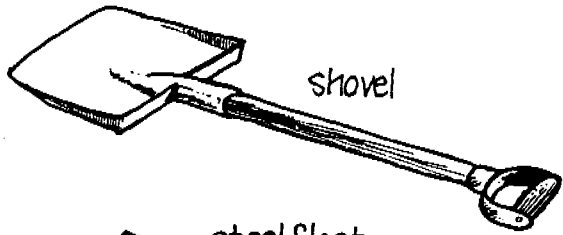

shovel

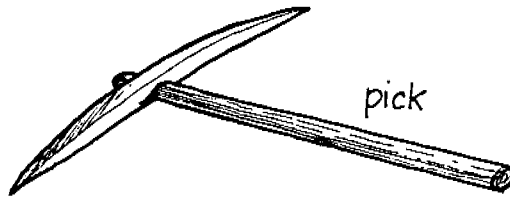

pick

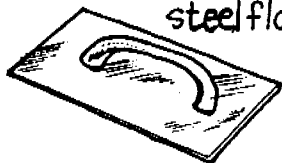

steelfloat

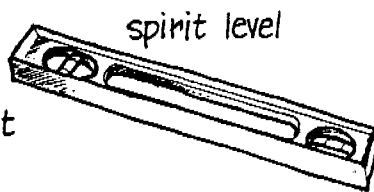

spirit level

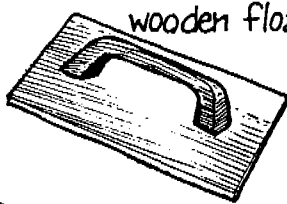

wooden float

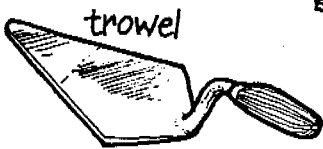

trowel

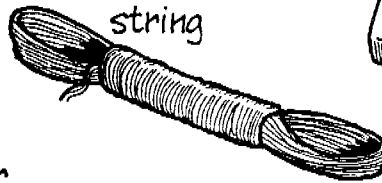

string

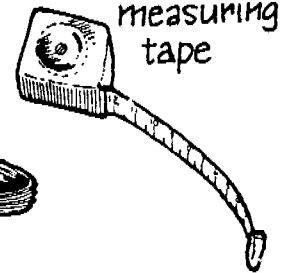

measuring tape

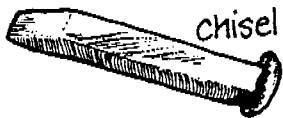

chisel

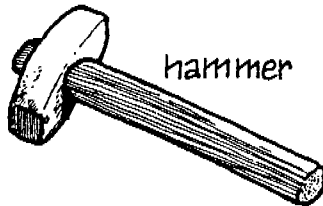

hammer

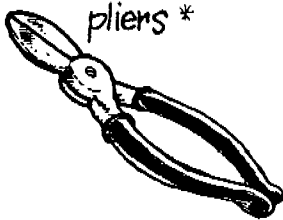

pliers *



2 buckets

* the pliers are used for cutting wire



ladder



stone chips

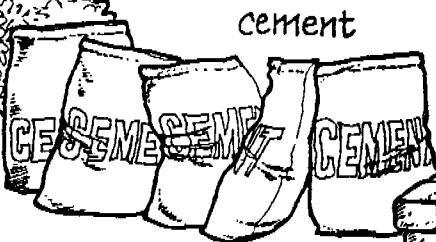

cement

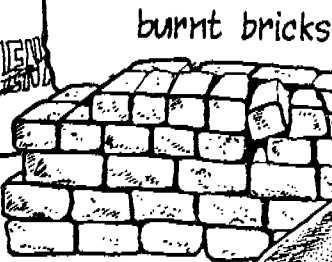

burnt bricks



reinforcing wire (8 gauge)

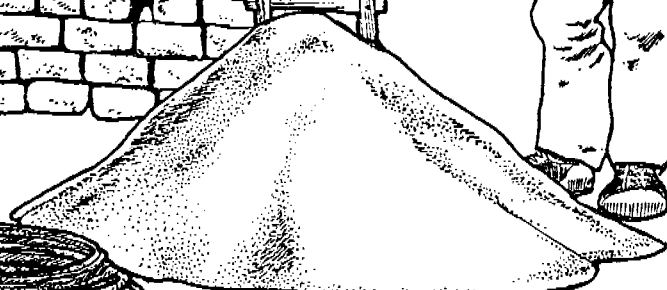

river sand



rope



Step 1 Site the well

The decision to site a well is reached by the group who will share the water supply. They are assisted by the community workers and others such as traditional diviners who specialise in seeking water.

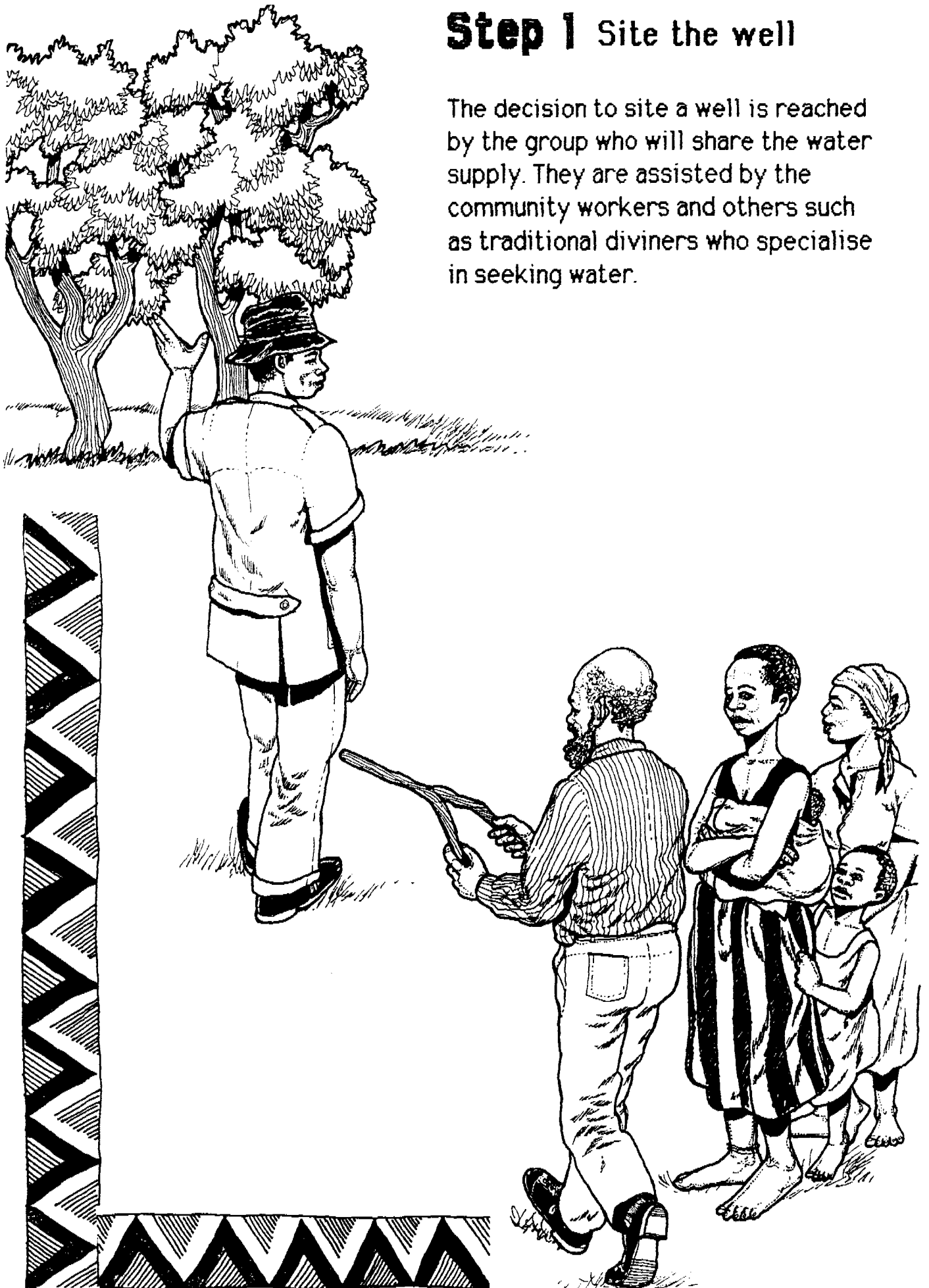



A good site for a well is

- * 30 metres (100ft) uphill from the latrine or rubbish pit so that contaminated waste does not drain into the well.
- * uphill and away from cattle kraals and from large hollows in the ground
- * on one side from latrines, cattle kraals, refuse pits if there are no hills nearby
- * on a rise so that waste water can drain away from the well into a garden
- * in a place which is near the homes of all the users
- * on a site which can be reached at all times of the year
- * a site which provides sufficient water near to the home for the users at all times of the year.

Other natural signs such as trees (the muondo tree, the mukute tree) and grasses which grow only in wet places be also be used to find water.

Step 2 Mark out the circumference of the well

Decide on the finished diameter of the well (usually about 1,5 m (5 ft) if bricks or stones are used for lining).

Mark out the well.

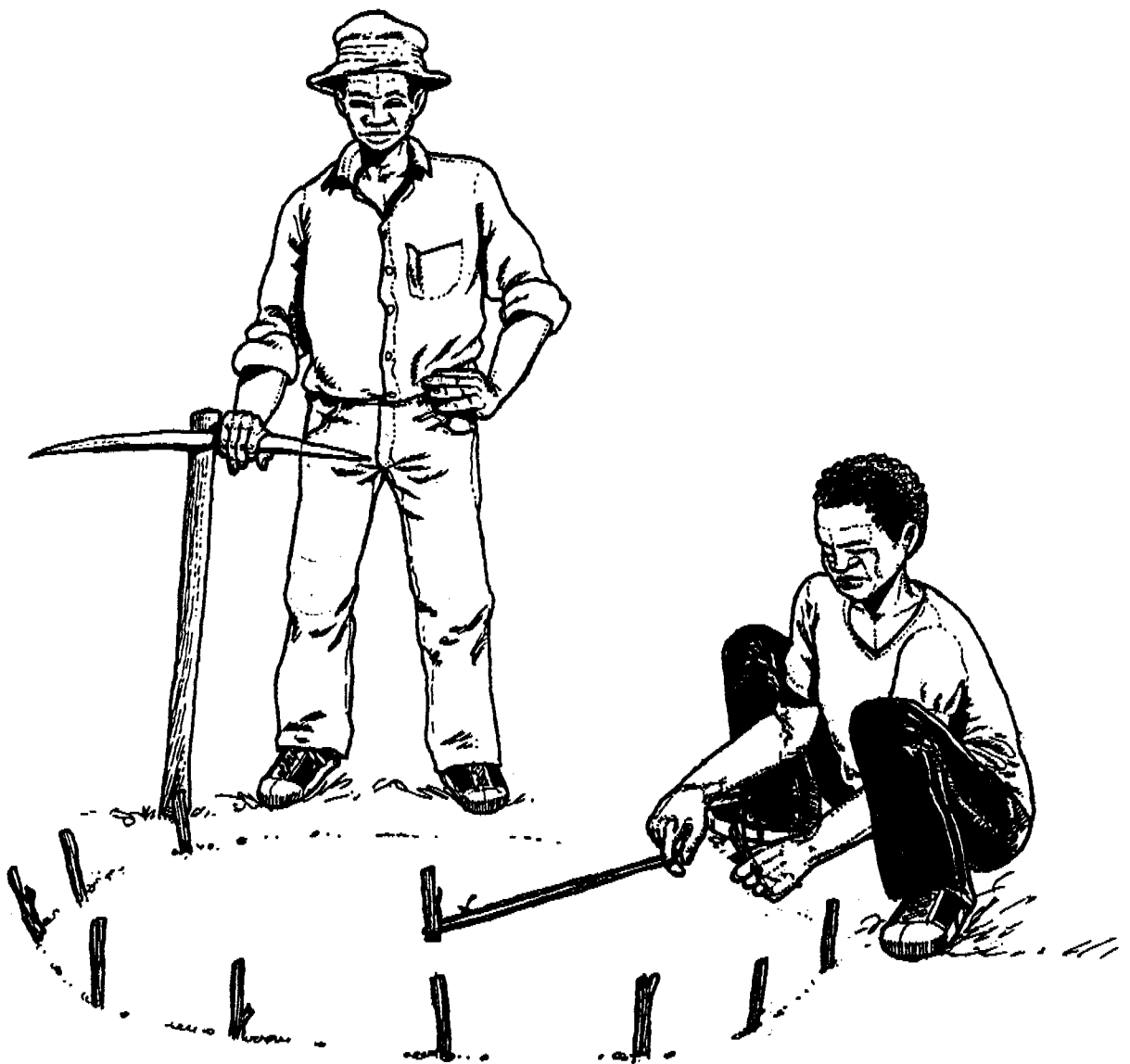

To do this

- * cut a piece of string which is the same length as the diameter of the well
- * place a peg in the ground
- * loop the string around the peg
- * use the string as a guide, and mark out the circumference of the well

Safety rules for well digging

Well digging can be dangerous.

Follow these rules for safety.

1. The best time to dig a well is at the end of the dry season. It is the safest time and the underground water level is at its lowest.
2. Tell the group when digging is being done.
3. Always have a helper nearby when digging. **NEVER DIG ALONE**
4. Stop digging at once if any signs of collapse are noticed.
5. Cover the hole when digging is not in progress. This will prevent children or animals falling inside. Do this with strong poles or branches from thorn trees.

Step 3 Begin to dig

Keep the same diameter from top to bottom **

Keep the sides straight

Remove soil from inside the well as it is dug.

Safety rules

1. Cut steps in the sides of the well so that the well digger can climb out easily when he needs to.
2. Stop digging if the sides of the well begin to crumble and show signs of collapse.

** **Important:** Some well diggers like to make the diameter smaller (1,2 m) when they reach harder ground. This is fine.



Step 4 Continue to dig even when water is first reached.

When water is first reached

- * remove water and mud quickly. Use two buckets to do this
- * continue digging until hard rock is reached and at least 50 litres of water is removed over 2 days. This means there will be enough water in the well for the needs of a large group of users.

Safety rule

When water is reached, extra helpers are necessary. They can assist the well digger to remove mud and water from inside the well.

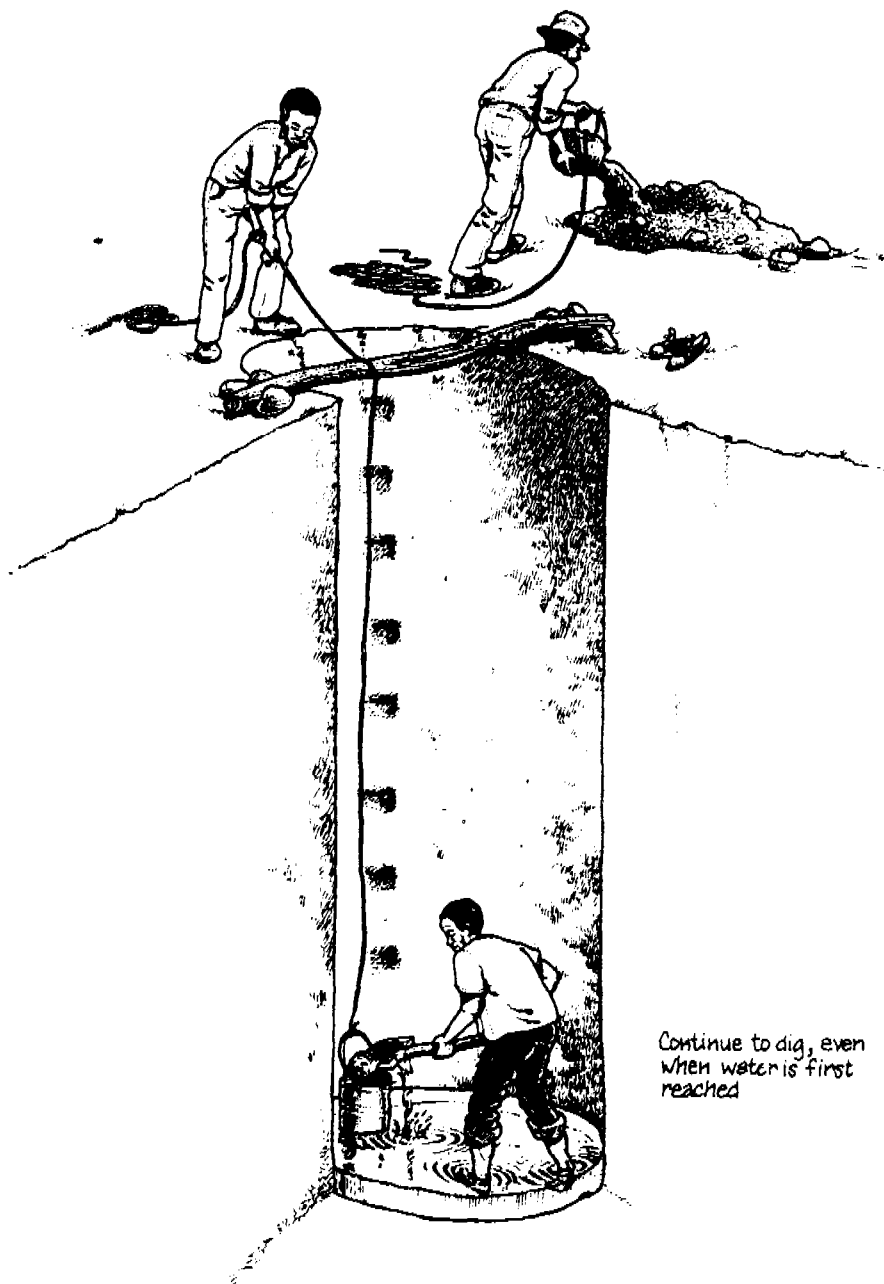

Step 5 Line the well

All wells except those which are cut or blasted through solid rock, should be lined using burnt brick, cement bricks, stones, concrete well liners or concrete.

The lining is important because

- * it protects the well by reducing pollution from seepage
- * it protects the water from soil
- * it prevents collapse of the sides
- * it helps to make the well last longer

One or more methods can be combined to line a well. In areas where there is hard rock or the soil is stable, line only the top half of the well.

Method of lining	Advantages	Disadvantages
Burnt bricks. Stones.	<ul style="list-style-type: none"> * Bricks can be made by the group. * Stones can be gathered by the community. * Cost of materials is less. * No special skills are required, i.e. the group can do this without the assistance of experts. 	<ul style="list-style-type: none"> * Bricks may not be burnt properly. * Wood is needed for burning bricks. * Groups may not participate fully.
Cement bricks Cement well liners * Concrete **	<ul style="list-style-type: none"> * These materials make strong lining and are easy to make once a person is trained 	<ul style="list-style-type: none"> * There may be only a few ring moulds available and progress becomes slow * Skill and training is needed * Cement is expensive

* These are made using steel ring moulds which are available in some parts of the country.

** In some areas the lining is made of concrete. Well diggers use steel shutters for this task.

The well is lined from the bottom except where there is solid rock. In such cases the well is lined for only 2-3 metres near the top. All well linings are raised to a height of at least 30 cm above ground level.

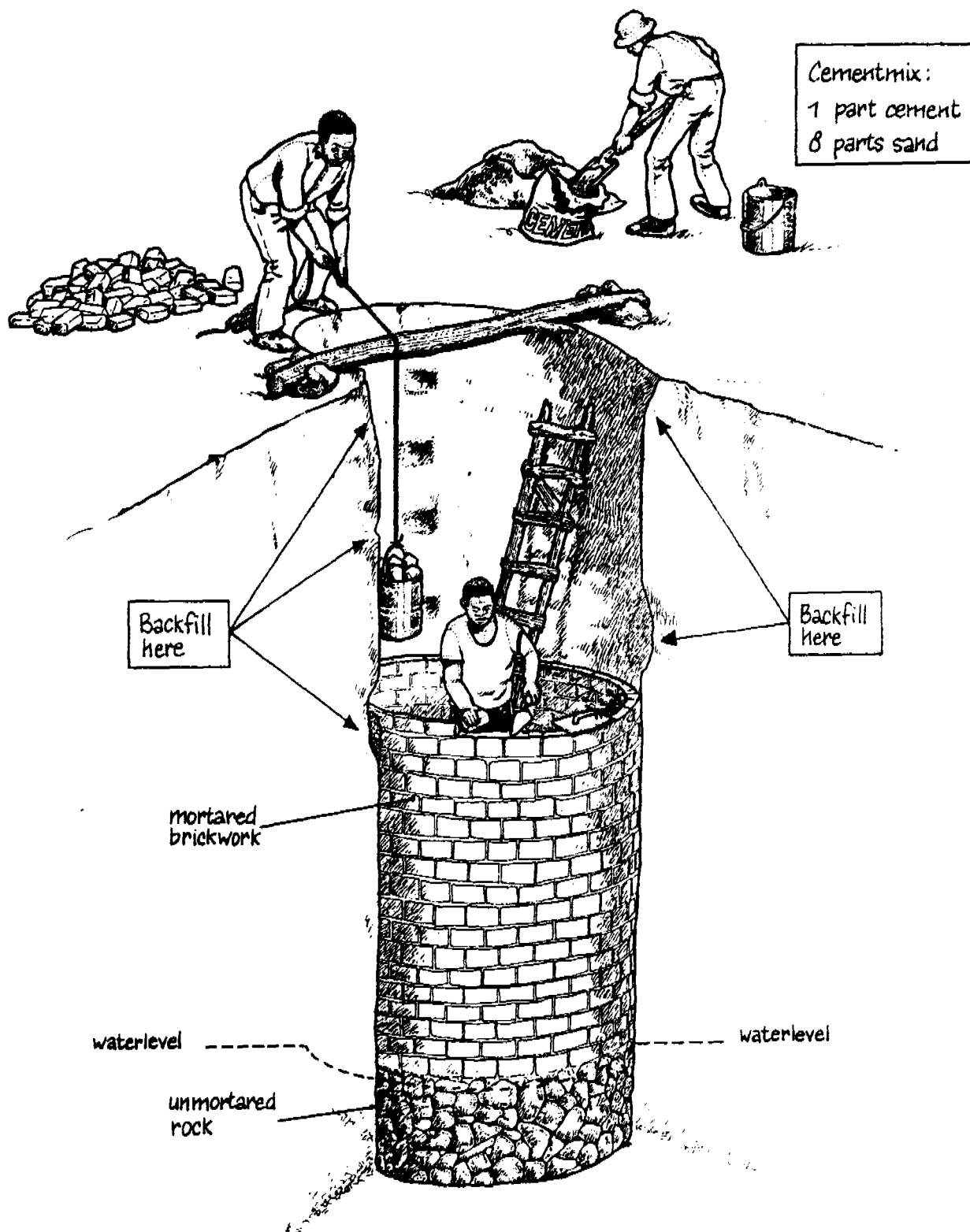

Note: It is usually necessary to backfill when lining the last three metres of the well. Backfill is always used when improving and lining a traditional well.

Step 6 Make a raised collar for the well

To make a raised collar build the well lining above ground level

The lining must be raised at least 30 cm (1 ft.) above the ground.



Raise the lining
at least 30 cm
above ground level

This

- * prevents run off water from spilling back into the well
- * prevents erosion at the edges of the well
- * provides a strong foundation for the cover slab.

Note: Backfill around the brick collar to prevent erosion of the soil.

Step 7 Prepare a protective cover slab for the well

A concrete cover slab for the well can be made in one or two pieces. An opening is made in the slab through which a bucket or pump can be passed into the well. The finished cover slab will rest on the raised collar of the well.

The cover slab is important because it

- * prevents waste water draining into the well
- * protects the well, prevents things from falling into the well and makes it safer for children
- * provides a safe resting place for a pump
- * is long-lasting
- * is easy to build and maintain

To do this

- * clear and level a place close to the well
- * estimate the diameter carefully. This should include the width of the cover slab, the brick or stone or cement lining and the backfill area. Allowance is also made for the overhang. Use string or tape to do this
- * mark out the diameter carefully
- * use bricks to mark the edges of the mould
- * lay old plastic bags or sand inside the mould so that the slab does not stick to the ground when it is completed

*Build according
to instructions*

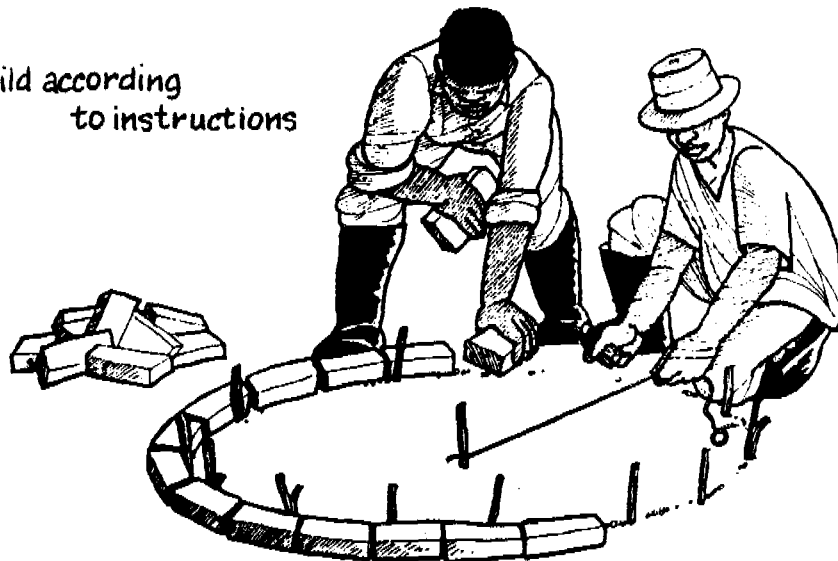

Step 8 Make the protective cover slab

Pour a 17 cm layer of concrete around the tin or brick templates inside the mould.

Cut reinforcing wires and lay 30 cm apart (or use one inch chicken wire) on top of the concrete layer.

Pour the remaining concrete mix on top of the reinforcing wires. Smooth off with a wooden float.

The finished slab is 15 cm (3 inches) thick when completed.

Cover with wet sacks and leave to dry for 3-5 days before moving.

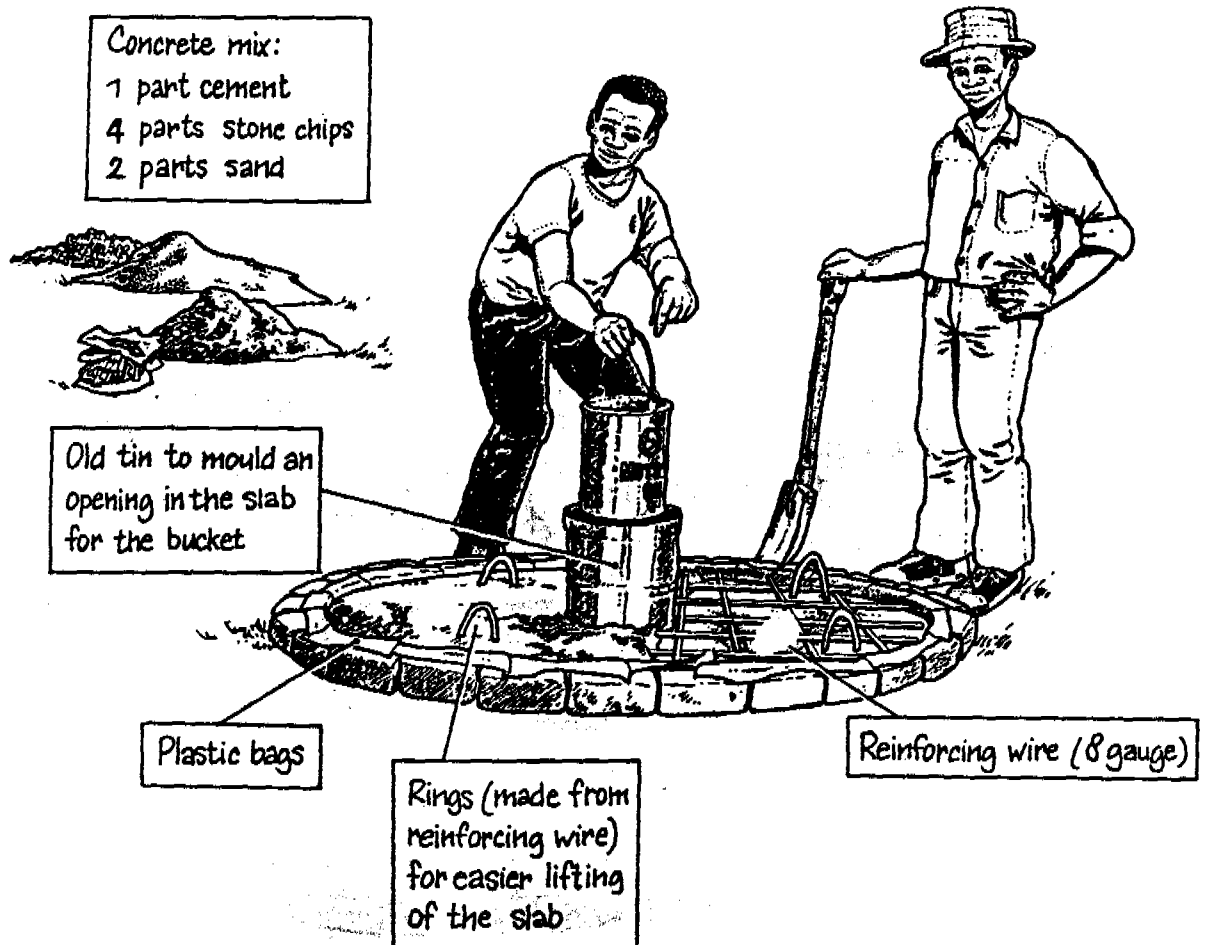

A protective cover slab can also be made in two pieces

If possible, it is better to make the cover slab in two pieces.

This is because

- * it may become necessary to inspect the well or raise the pump fittings. It is simple therefore to move over one part of the cover slab.
- * it is easier to lift the cover slab onto the collar if it is made in two pieces
- * a slab of two pieces is stronger and there is less risk of cracking

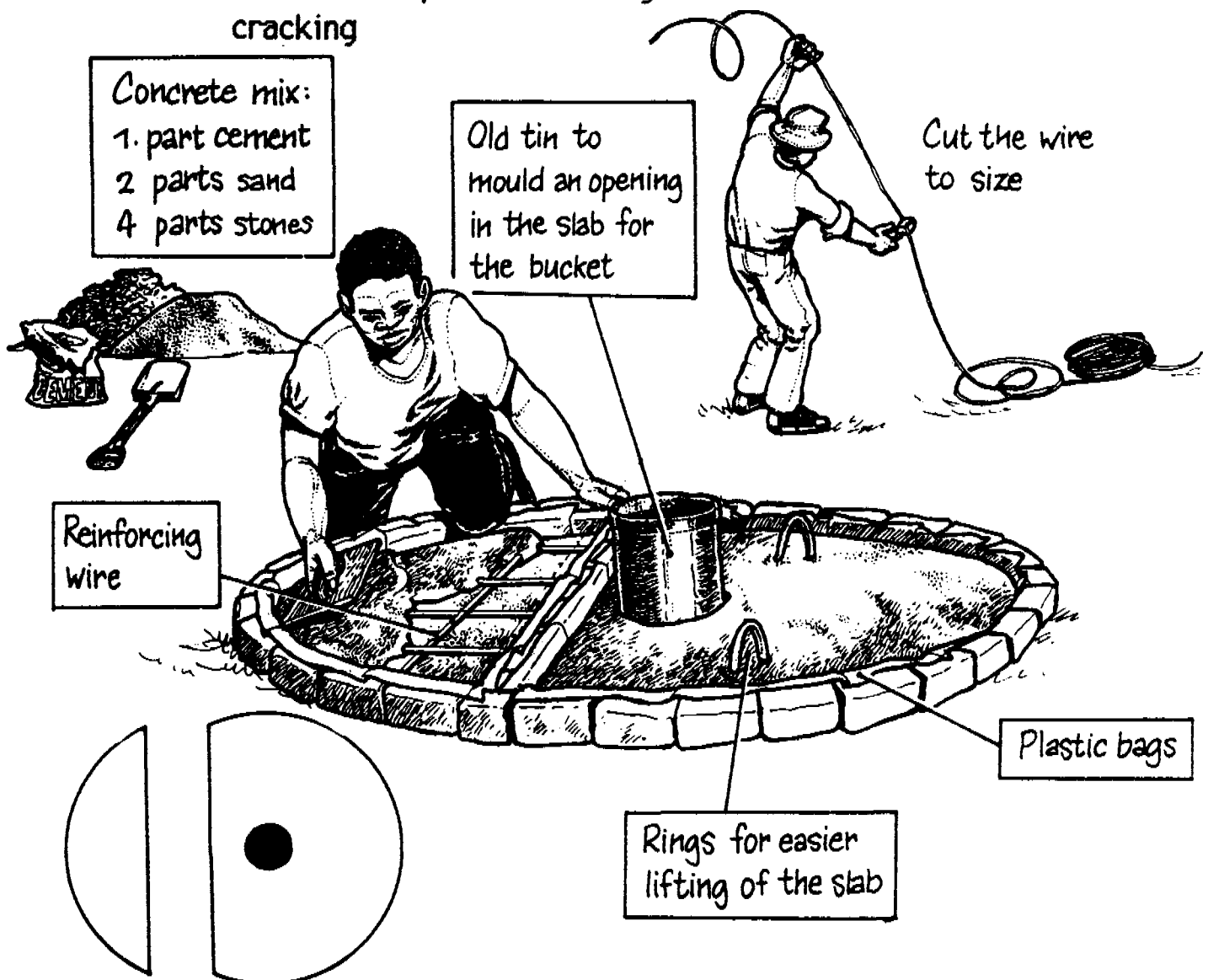

- * divide the mould with bricks as shown in the pictures
- * have an old tin or templates ready to mould an opening in the slab for the bucket or pump. The size of the opening should be larger than the bucket normally used by the group to raise water.

Step 9 Lift the cover slab into position over the well

The cover slab is positioned on the raised collar above the well. Extra help is needed for this task.



The cover slab is mortared onto the raised collar.

These diagrams show the different methods recommended for raising water from a well after the cover slab is fitted

A Blair hand pump is fitted to raise water from shallow wells (12-15 m) and tube wells

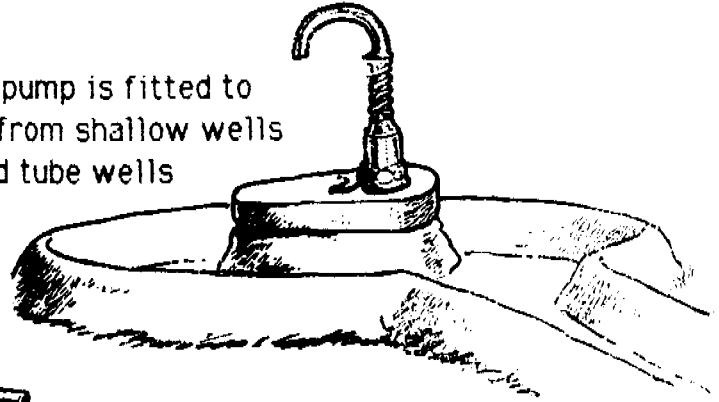

A bucket pump will also raise water from shallow wells and tube wells

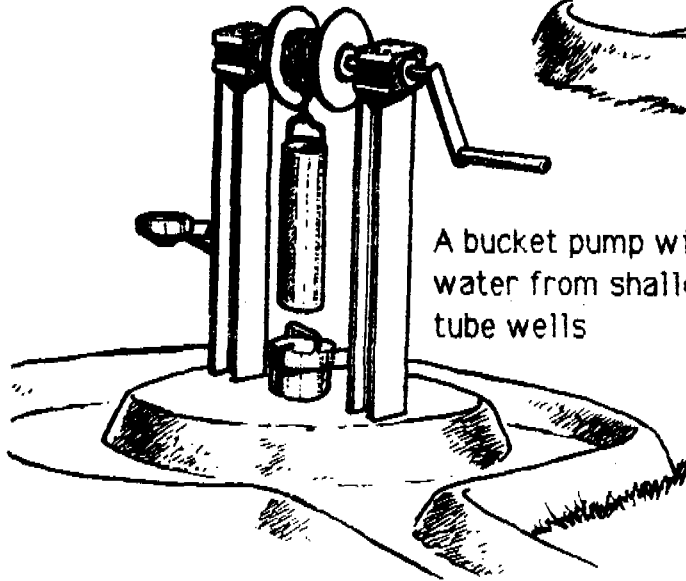

For more information about how to fit these pumps ask for the Pump Handouts

The Bush pump is a heavy duty pump which is used to raise water from shallow wells and deep wells

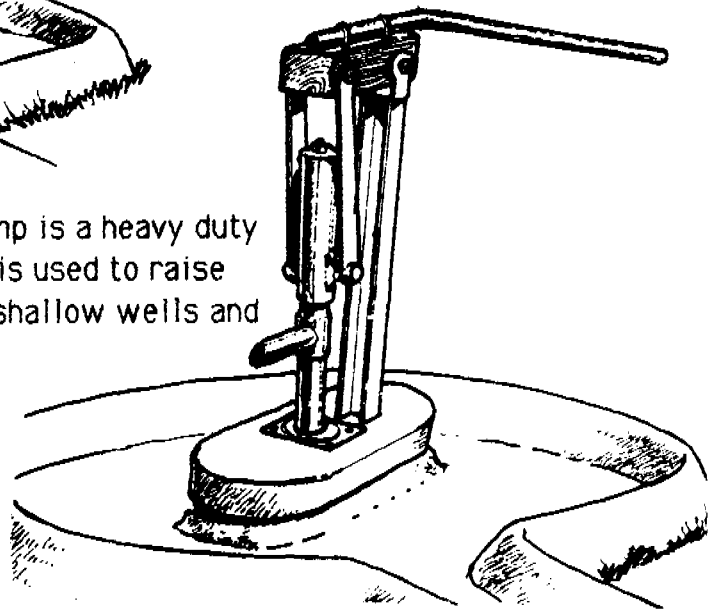

In shallow wells a windlass can be used to raise water. This method is described on pages 28-29 of this book

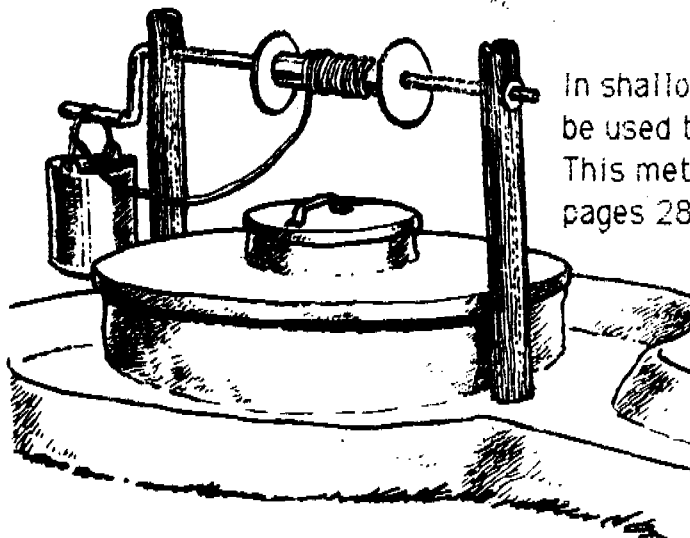

Step 10 Complete the well and make a drainage area too

The drainage area (also called the apron and run-off channel) is important because it

- * helps waste water drain from the well quickly and easily
- * prevents stagnant water from collecting around the well
- * prevents erosion around the top of the well
- * channels waste water into a garden or watering trough
- * keeps the well area free from mud and easy to clean

To complete this task

- * measure a 3 m diameter circle around the well
- * mark the edge of the circle with stones or bricks
- * backfill the area between the bricks and the well with smaller stones or broken bricks
- * cover these with concrete and reinforce with steel wire to prevent cracking
- * smooth the concrete surface of the apron
- * slope a 10 m long run-off channel towards a soak away pit, vegetable garden or animal watering trough

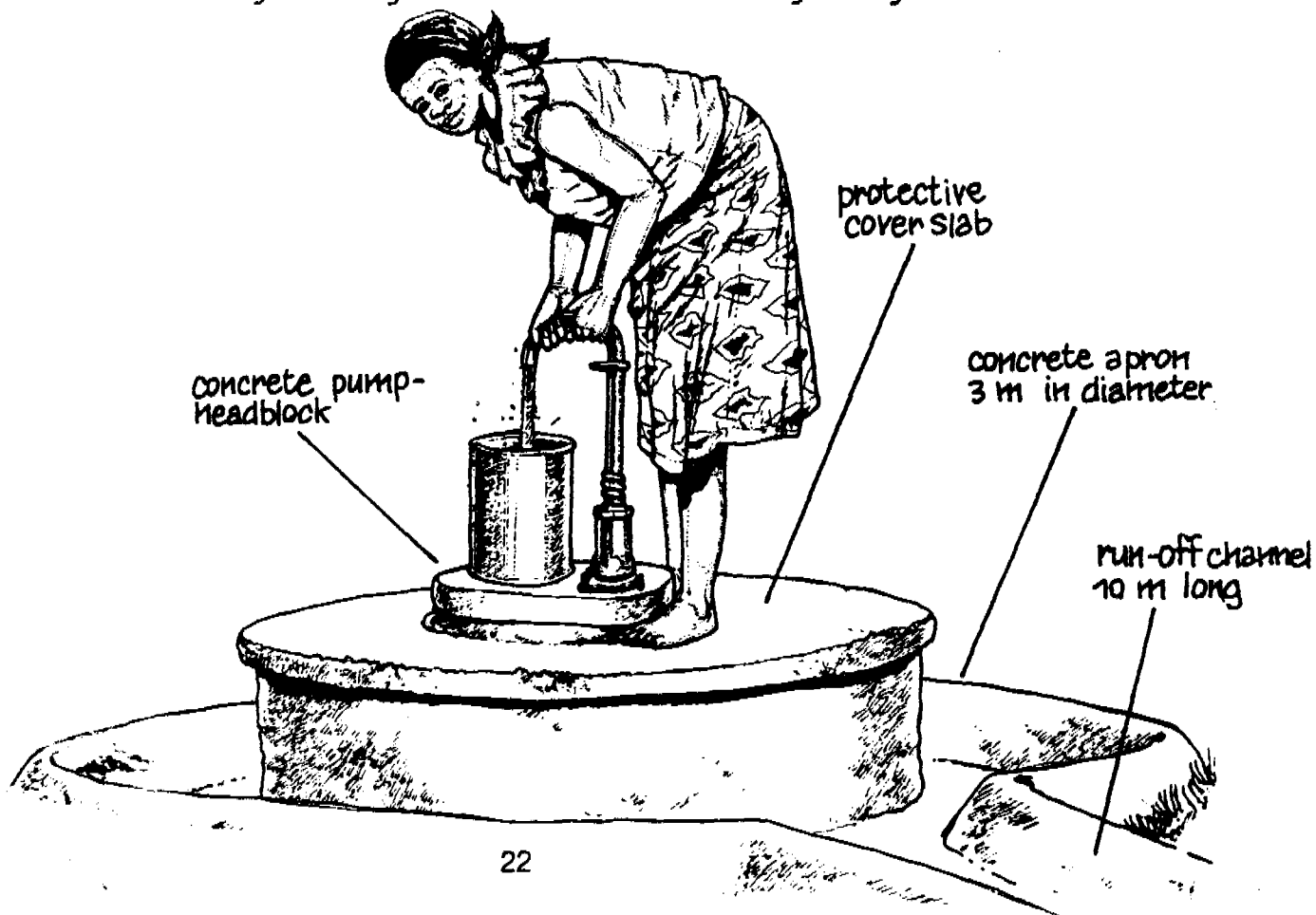



**Improving
a
Traditional
Well**



The need to improve Traditional Wells

There are thousands of traditional wells throughout Zimbabwe. Many are badly sited. They are far from the home and the user must walk long distances to collect water for their daily needs. Some traditional wells are downhill from community cattle kraals, latrines and rubbish pits so that disease carrying germs easily drain into the wells. Where the traditional wells are unprotected, badly sited, in danger of collapse or provide too little water, it is better for groups to build new wells. If the traditional well is near to the homes of the users, correctly sited and provides adequate water at all times of the year, then it is better to improve the supply.

When combined with education about hygienic practices for collecting and storing water the group will benefit from their efforts to raise better quality water.

The quality of water in traditional wells can be improved by following the simple steps described in this book.

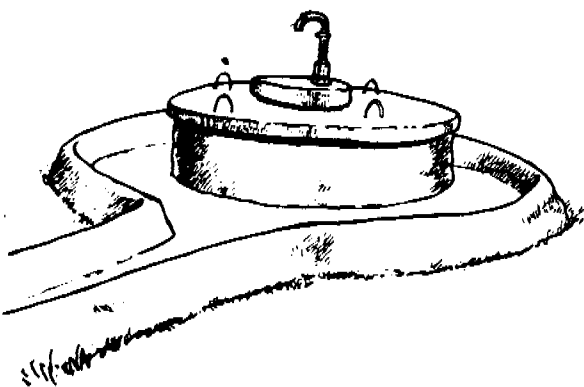
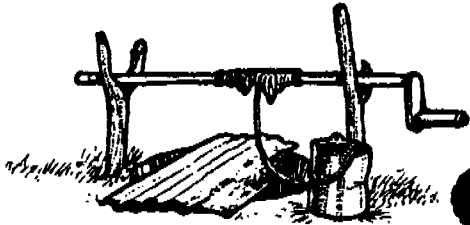

Traditional wells
can be improved
through
group effort

How to improve a Traditional Well: step by step

Efforts to improve a traditional well will be rewarded if each task is done properly. Follow these steps carefully.

Step 1 Clean and deepen the well

Remove mud, stones and rubbish
Make the well deeper if possible

Step 2 Line the well and backfill

Below water level: stack rock on the sides of the well. Do not use cement mortar

Above water level: line the well with burnt bricks or stone. For this use cement mortar

Backfill with layers of gravel, cement and puddled clay between the old wall and new lining

Look at the picture on page 27 for more information about lining

Step 3 Raise the new lining 30 cm above ground level to make a collar

To do this follow the instructions on page 16

Step 4 Make a protective cover slab

To do this follow the instructions on page 17

Step 5 Fit a pump or windlass to raise water

Note: If a pump is chosen, follow the step-by-step instructions in the **Pump Handouts**. If a windlass is chosen turn to page 28

Step 6 Make a hygienic drainage area around the well

To do this follow the instructions on page 22

How to improve a Traditional Well

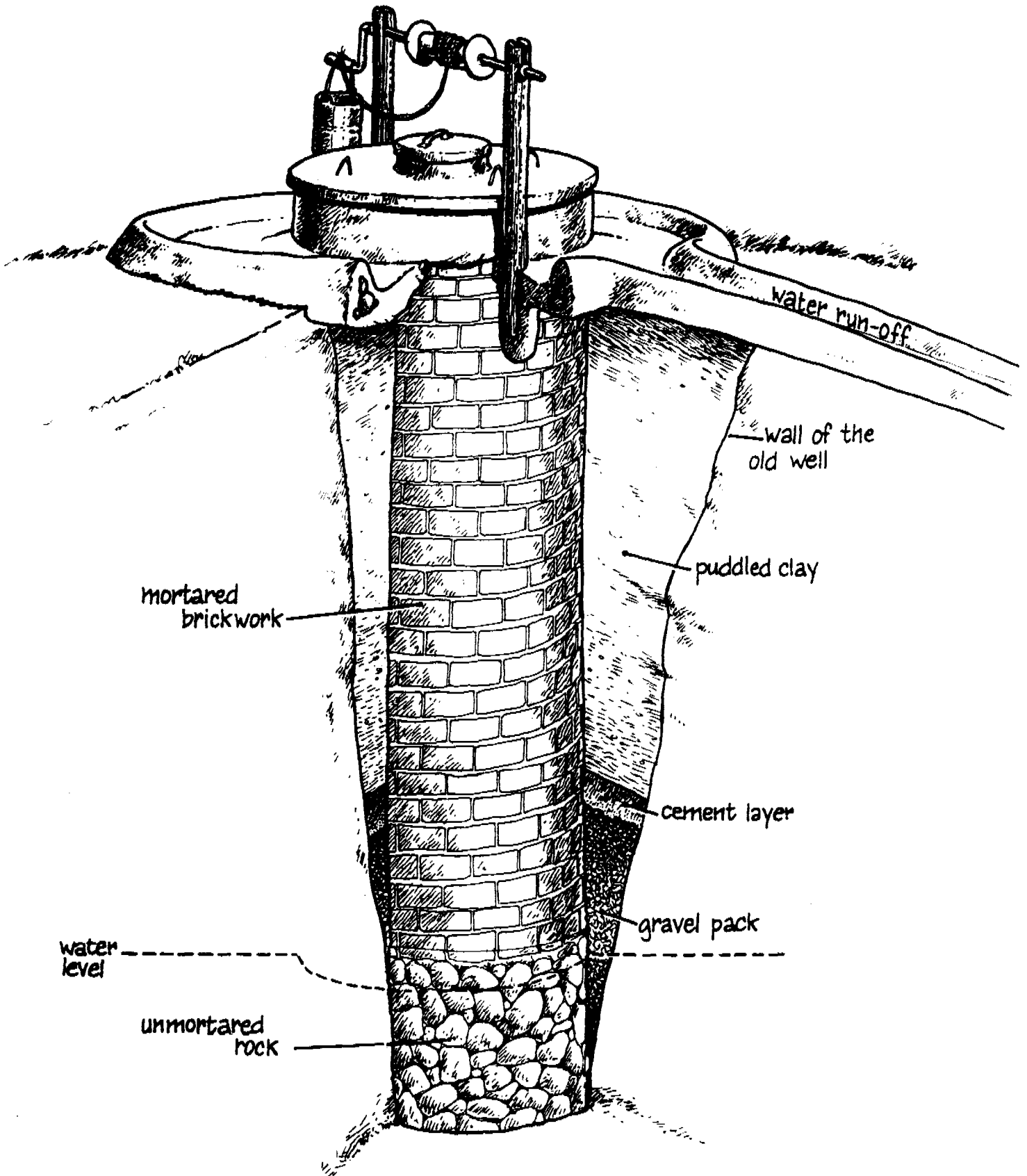

Method for fitting a windlass to a Traditional Well

1. After the cover slab is positioned over the well, make a protective collar around the opening of the well



2. Make holes for the windlass supports



3. Fit the windlass

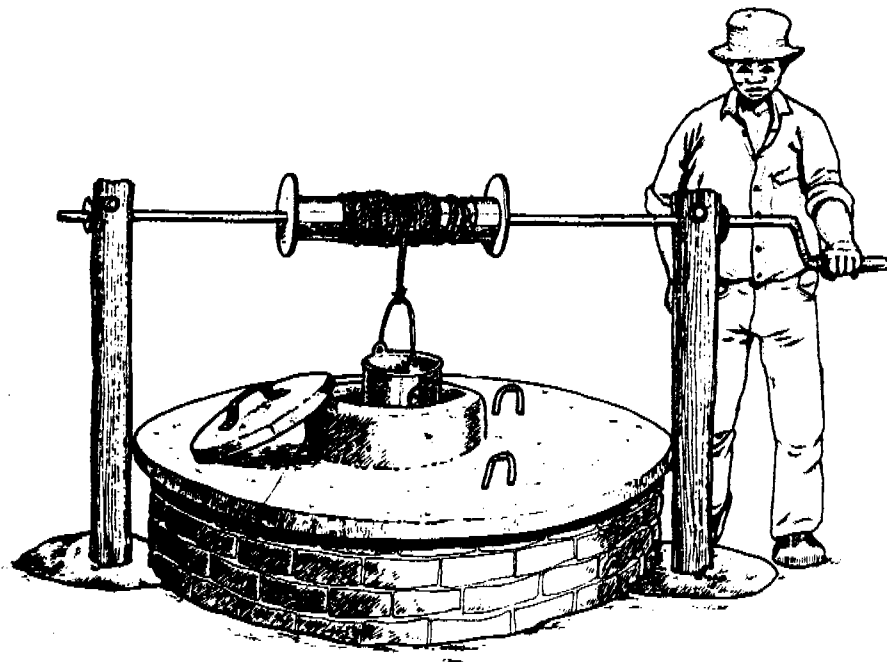

Now complete the project and build a drainage area around the well

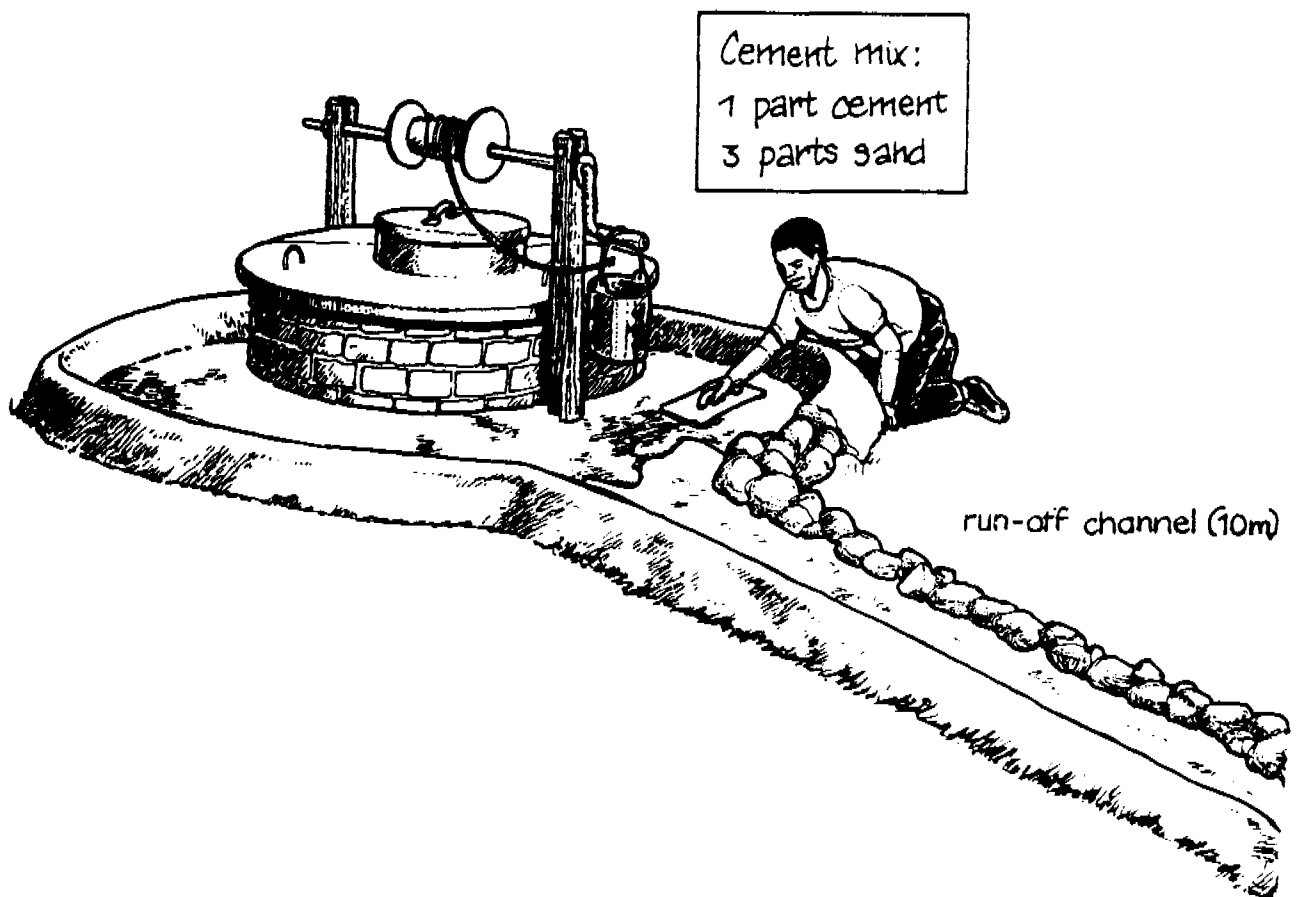

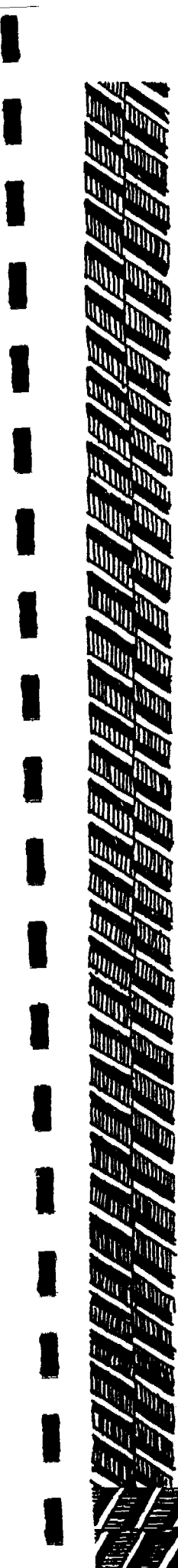

Water hygiene

Even if a well is properly maintained with a protective slab and a good drainage area, the water inside the well can be contaminated if the people do not use hygienic practices for collecting and storing water.

Water hygiene is important!

Encourage users to

- * collect their water in clean containers
- * store their water in clean covered containers
- * wash their hands frequently
- * make a hook on the windlass on which to hang the bucket when it is not being used
- * keep the rope or chain off the ground so that it does not get dirty
- * replace the protective cover over the well when the windlass is not in use
- * keep the drainage area free from dirt and mud
- * keep animals away from the area
- * teach hygienic practices to children (as they will very often be collecting the water)
- * maintain the pumps so that water can continue to be raised hygienically
- * use more water for body hygiene
- * use water for other development projects, such as growing food for the family

Good sanitation is important too!

Encourage people to support latrine building projects in the area.

Water For All

section three

extra information about
raising water with
different pumps.

- a Bucket pump
- a Blair pump

information about other pumps will soon be available

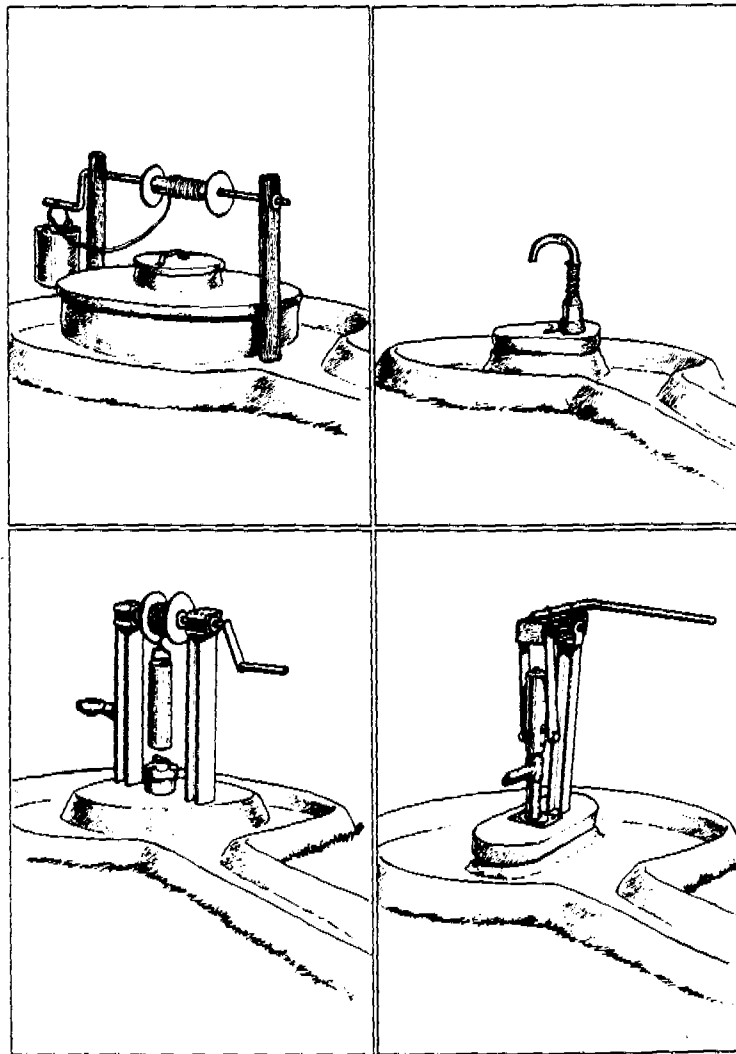

Raising water with different pumps

Pump handout No 1

The Zimbabwe Bucket Pump

The Zimbabwe bucket pump is a hand operated pump which is used to raise water from tube wells and hand dug wells in rural Zimbabwe. Bucket pumps provide a simple, safe and hygienic way of raising water for domestic use.

Bucket pumps are made in Zimbabwe. They can be easily installed by the community and will last for many years if properly maintained.

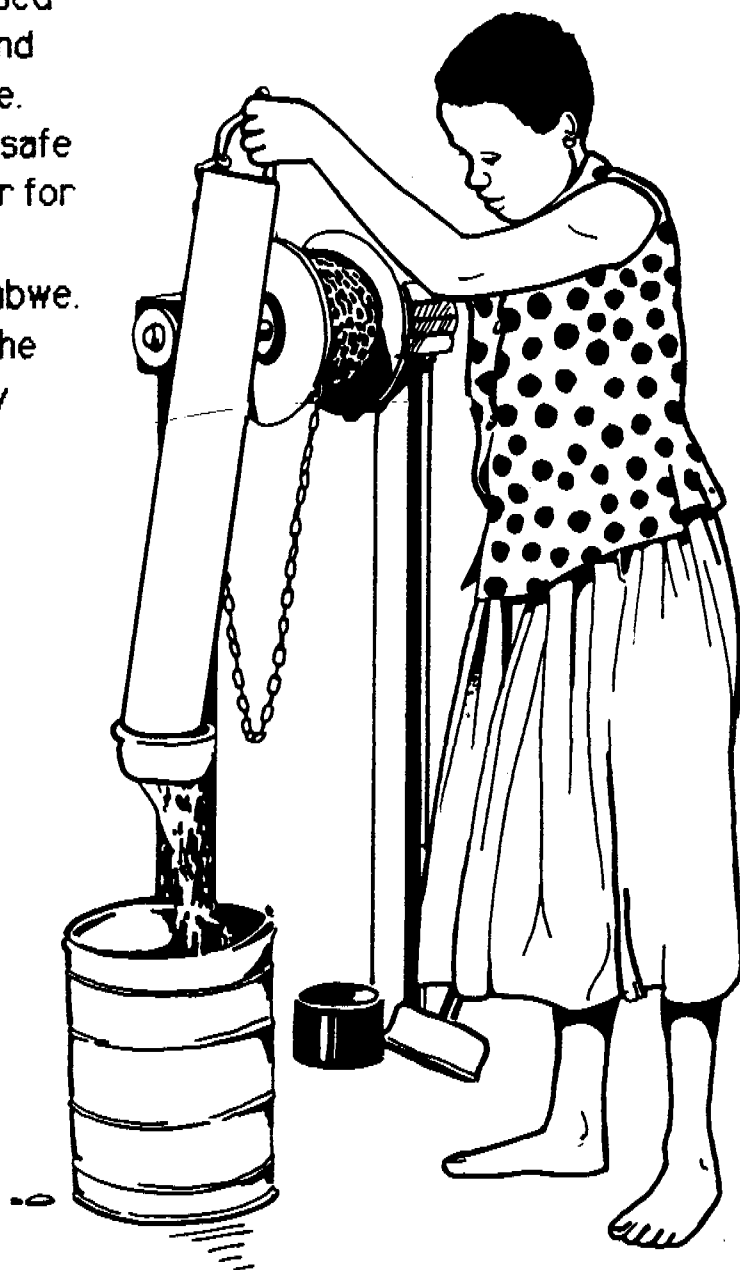

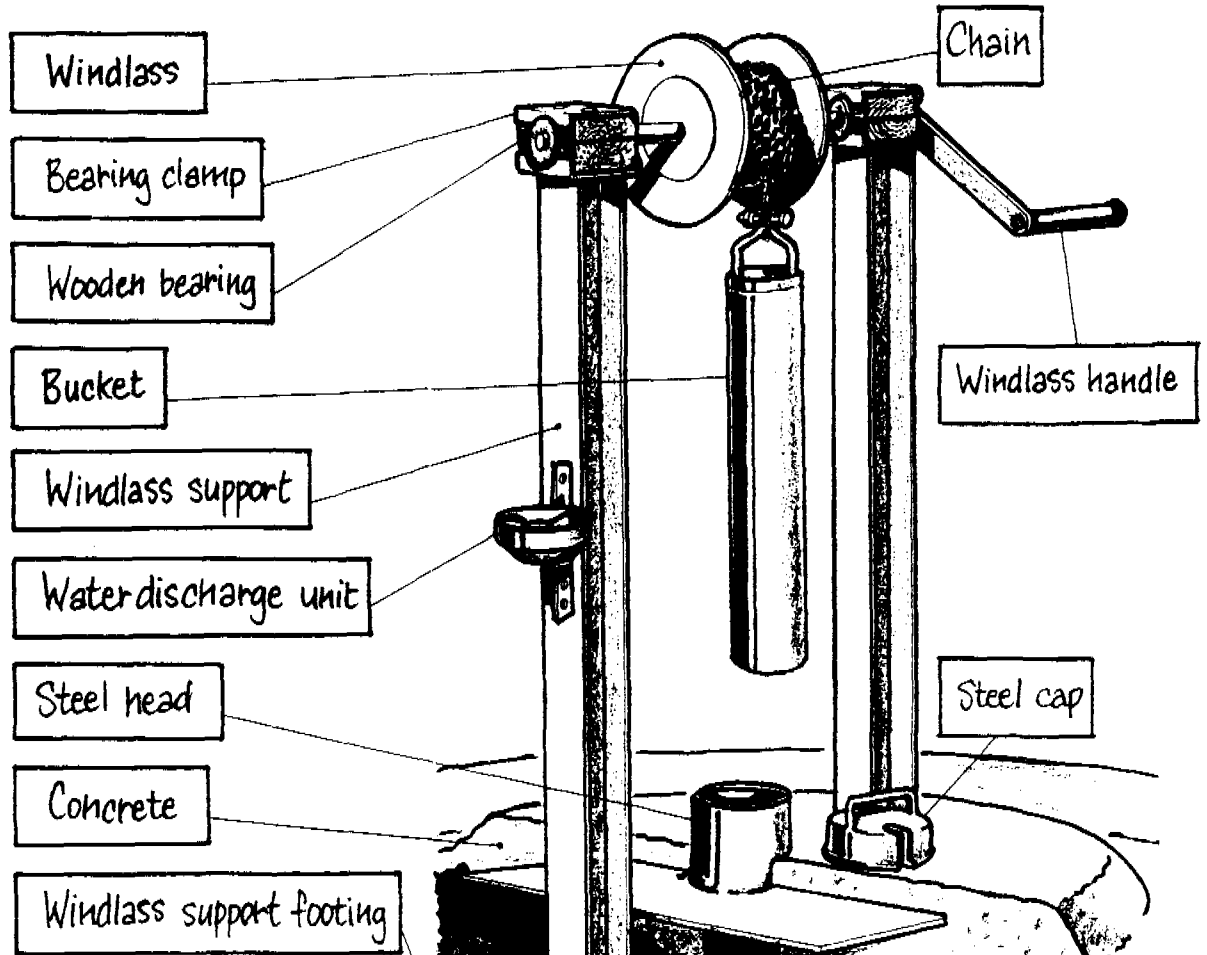

The bucket pump, how it works

The bucket pump is installed over a tubewell or a shallow hand dug or blasted well

The bucket, the steel head and cap, the windlass and the windlass supports are made of steel

The wooden bearings are made of hard wood

The bucket is lowered into the well on a steel chain which is attached to the windlass

The bucket is raised by the operator who winds up the chain, using the windlass handle

The operator rests the bucket on the water-discharger. The valve inside the bucket opens and water is released into a water-container

Different materials are needed for fitting a bucketpump to a watersupply

These tools are provided with the bucketpump. Check them!

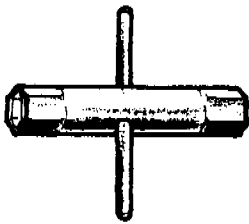

Short socketspanner

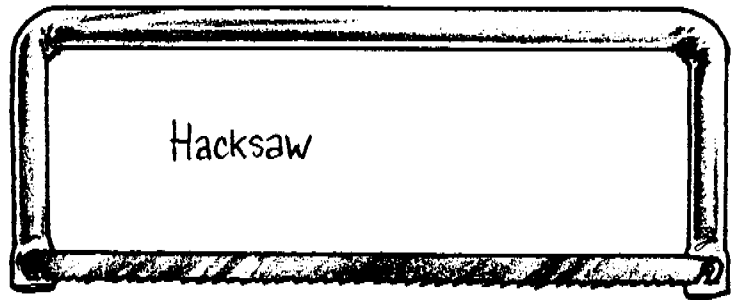

Hacksaw



Flat spanner

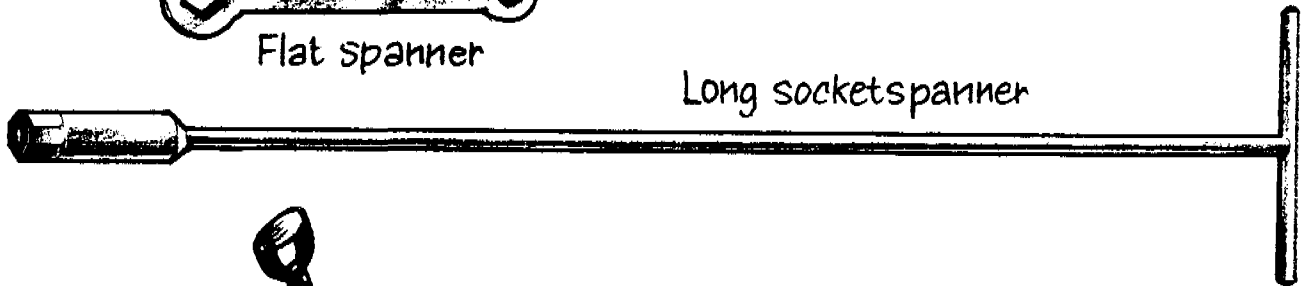

Long socketspanner

Materials needed for fitting the bucketpump

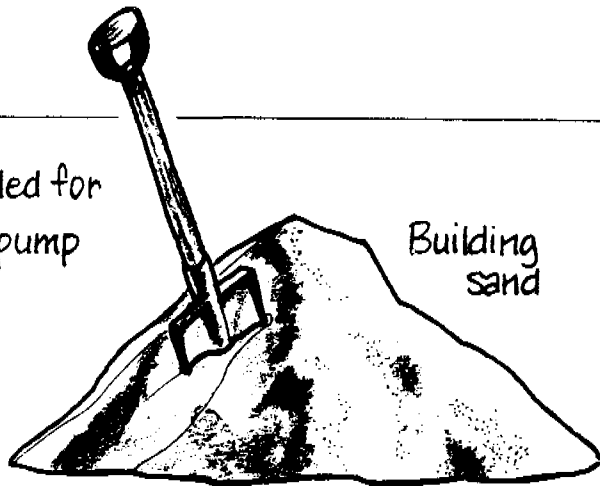

Building sand

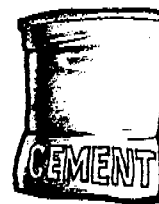

Cement (appr. 4 pockets)



Rocks for building the drainage area

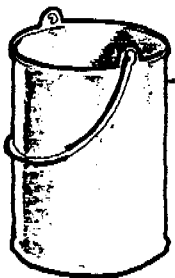

12 x 5 ltr buckets full of small granitechips or sieved coarse river sand

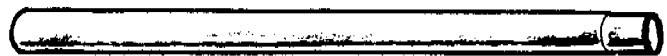

125 mm PVC casing class 6



FIT A BUCKET PUMP

STEP BY STEP

A bucket pump raises clean water from underground. A tubewell is drilled by the community using a hand operated drilling rig. The well is lined with 125 mm Class 6 PVC casing to prevent collapse. Then the bucket pump is fitted. A drainage area is built around the well. To assist, the community can bring

- sand & stones
- small gravel chips

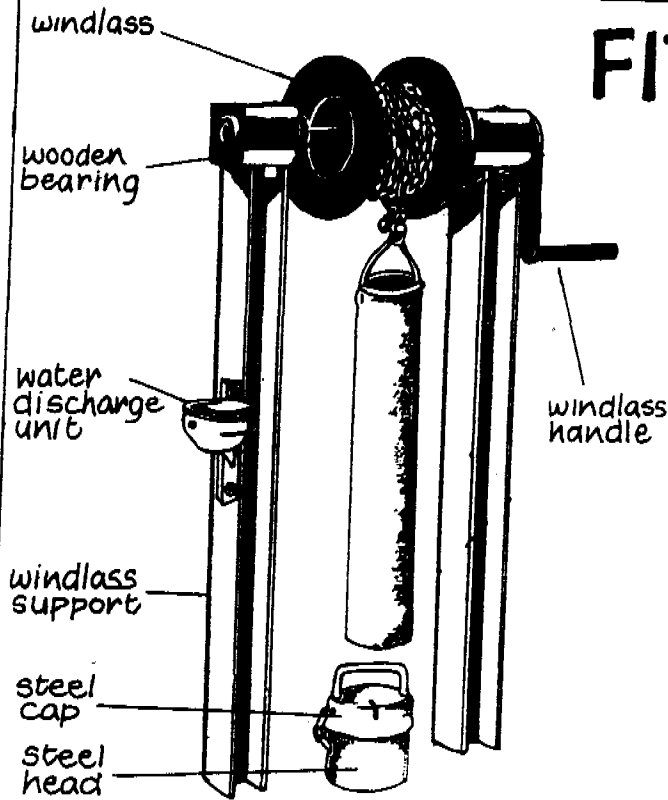

class 6 PVC casing & cement is also required

① after the tube well is drilled make a gravel bed at the base

use two 5 litre buckets gravel chips.

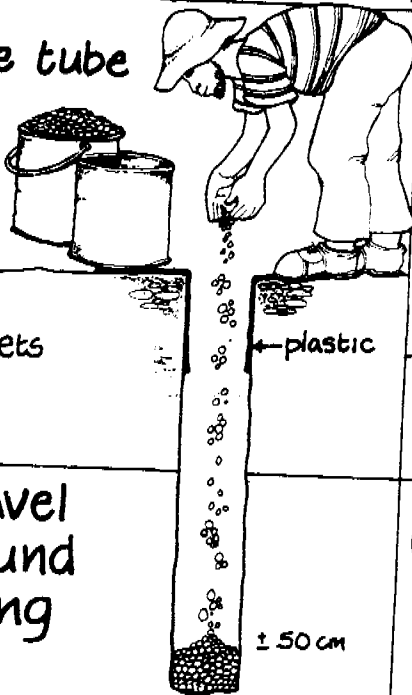

② lower lengths of (class 6) PVC casing inside tubewell

hold casing upright and straight

PVC casing
tubewell



③ pack gravel chips around PVC casing

gravel chips

leave 1 metre for concrete at the top of tubewell



④ pack concrete around top metre of casing inside tubewell

concrete mix
4 stone : 2 sand : 1 cement

1 m concrete mix



5 use a saw to cut PVC casing off 30 cm above ground level

- measure carefully
- cut straight
- Then cover PVC casing with plastic to prevent dirt falling into tubewell



6 on each side of the tubewell, dig holes for the bucket pump supports

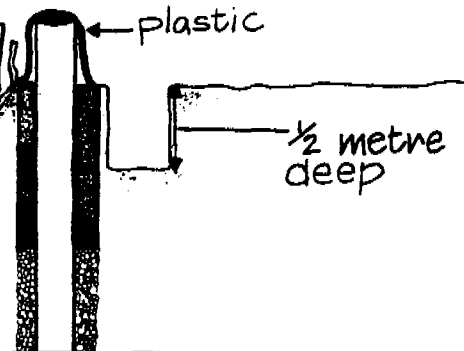

7 position the bucket pump

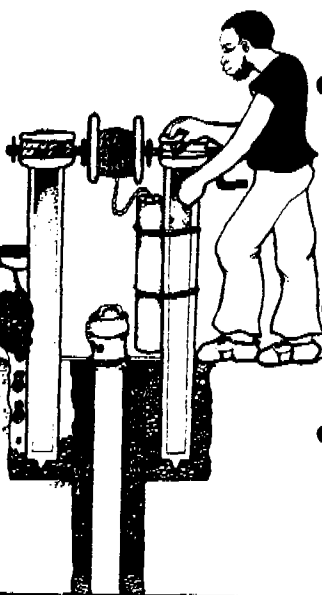

- fit steel cap over casing
- lower pump supports into holes
- level pump so it is upright
- backfill with concrete MIX 4 : 2 : 1

8 build a drainage area around bucket pump

- to do this, measure a 3m diameter circle around bucket pump
- mark with stones

- use concrete mix 4 : 2 : 1 to backfill drainage area

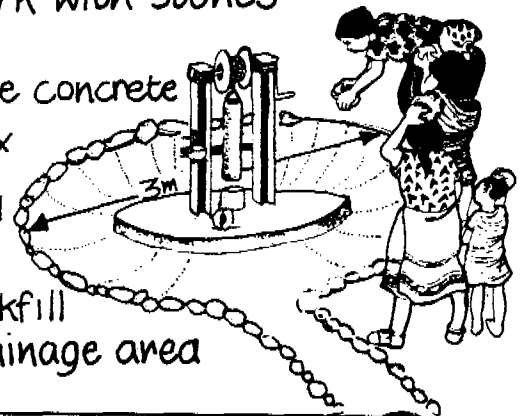

9 make a runoff channel to garden

slope drainage area to runoff channel. leave to dry for 3 days.

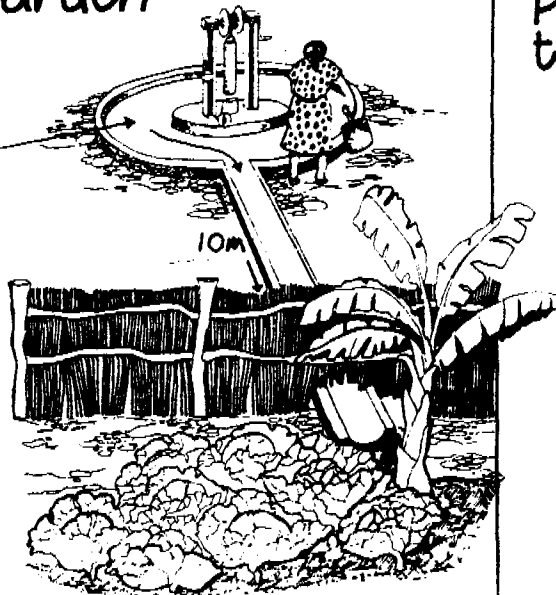

10 now the pump is ready to use!

- adjust chain carefully so that bucket does not hit base of tubewell

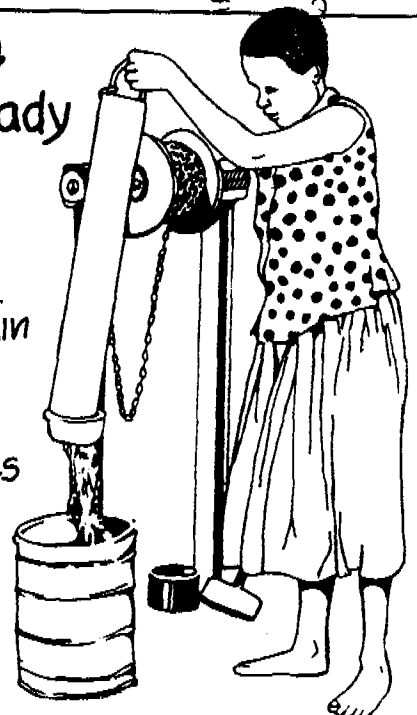

Extra information

about maintaining and making minor repairs to the bucket pump.

1

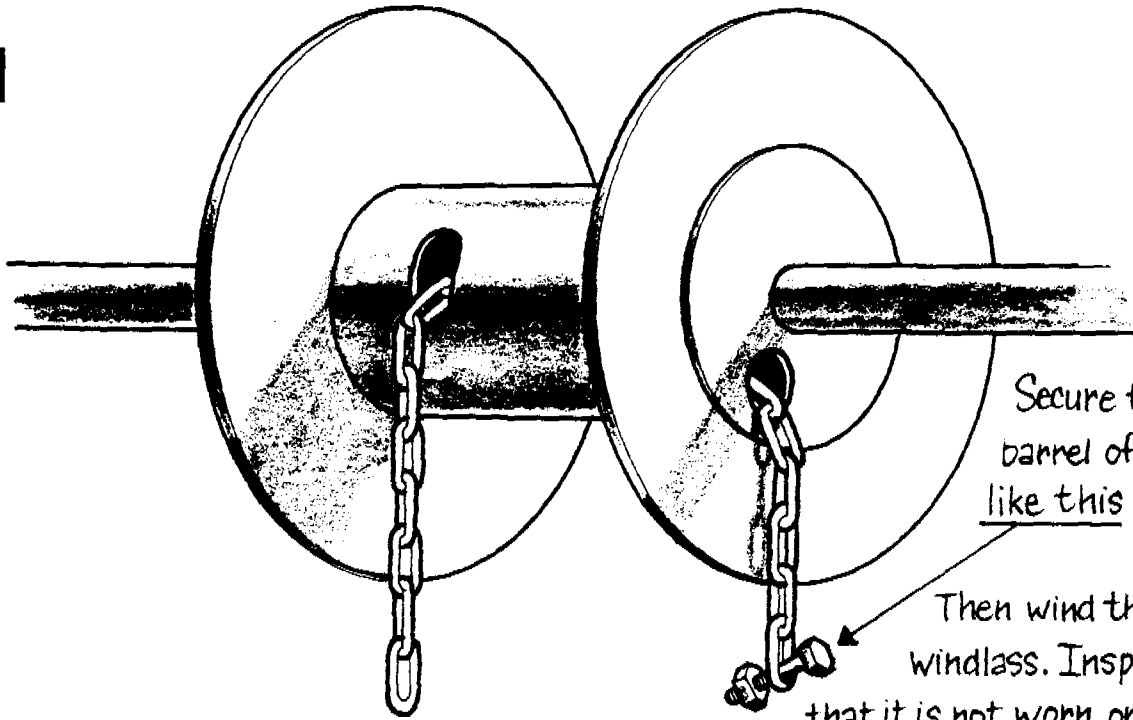

Secure the chain on the barrel of the windlass like this

Then wind the chain onto the windlass. Inspect the chain to see that it is not worn or rusted. Replace if necessary!

2

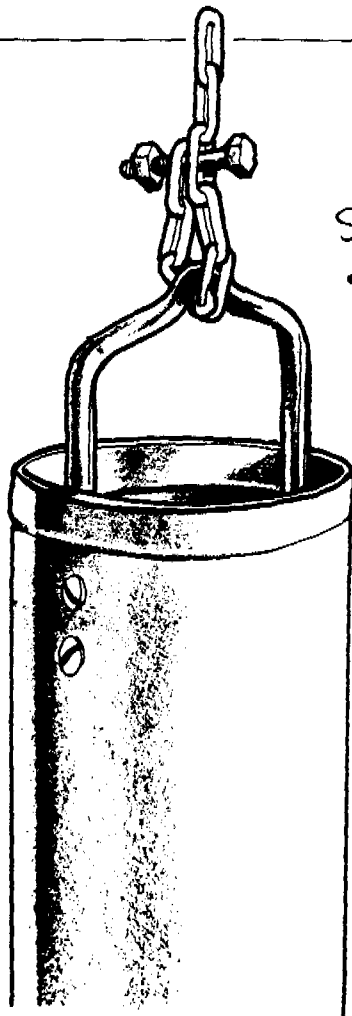

Secure the chain to the bucket.

- Use a nut and a bolt to do this.
- Wire can also be used for this task if necessary.

- Adjust the chain to prevent the bucket from hitting the base of the tubewell!
- Advise the people to take care when using the windlass.

3

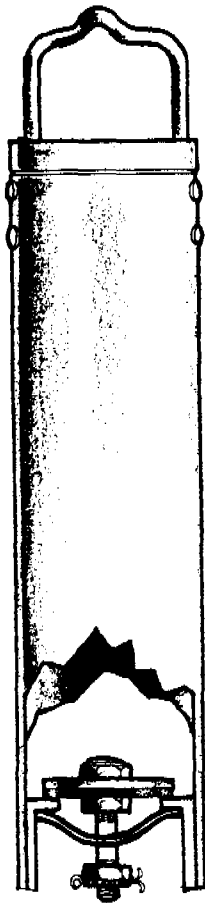

The bucket

The bucket valve is inside the bucket

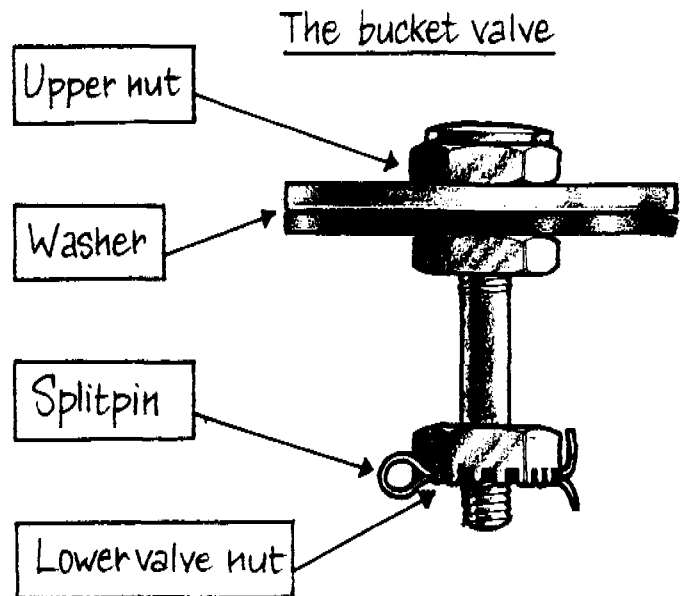

The bucket valve

Upper nut

Washer

Splitpin

Lower valve nut

4

To replace the washer:

- Remove the splitpin
- Use the long spanner to secure upper nut
- Use short socket spanner to unscrew the lower valve nut

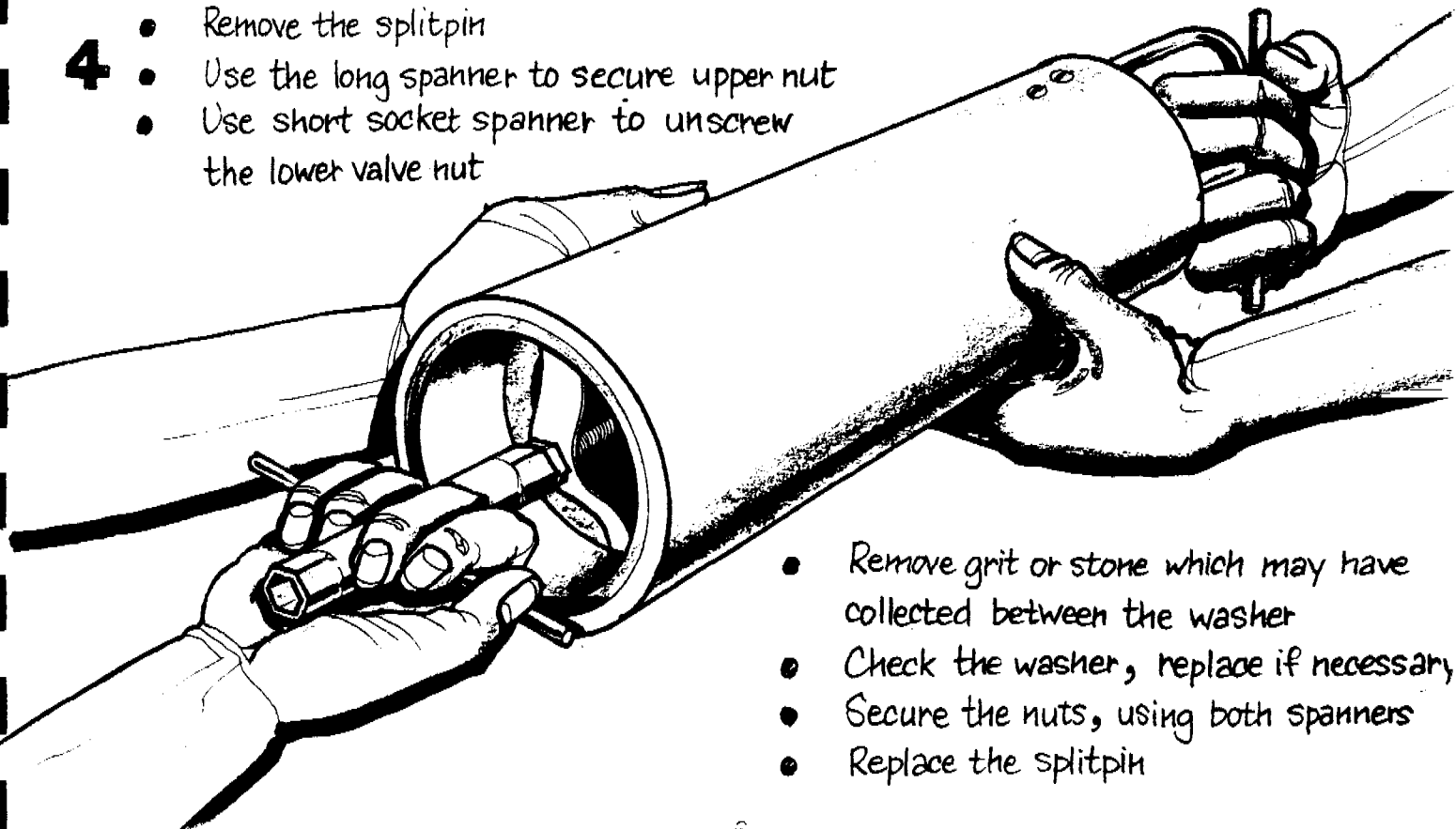

- Remove grit or stone which may have collected between the washer
- Check the washer, replace if necessary
- Secure the nuts, using both spanners
- Replace the splitpin

MAINTENANCE CARD

THE BUCKET PUMP.

CHECK.....all working parts regularly
REPAIR.....the bucket pump carefully
REPLACE.....parts when necessary

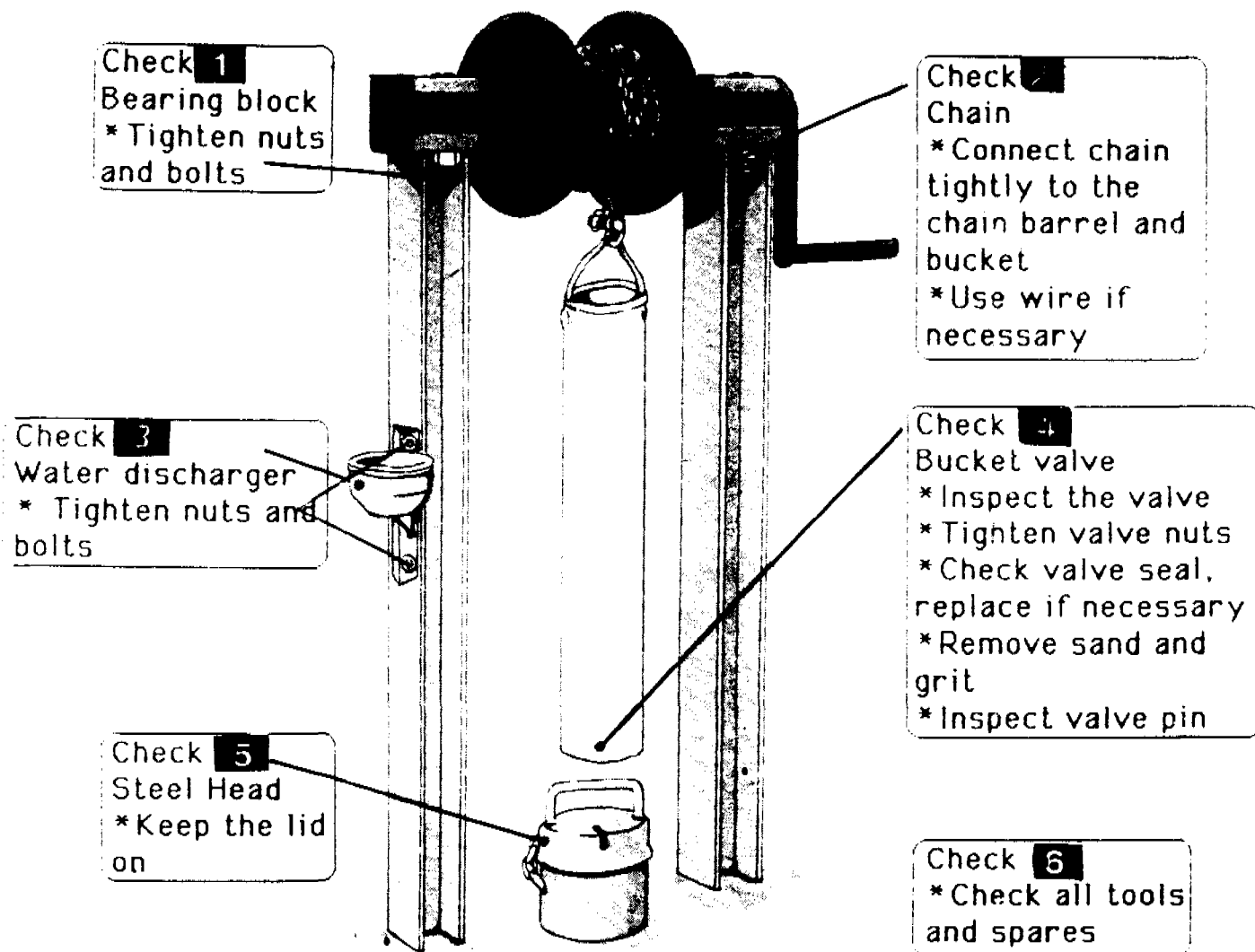

CHECK THIS PUMP EVERY WEEK!
COMPLETE YOUR CHECK BOOK EVERYTIME
SEEK THE ASSISTANCE OF THE HEALTH
WORKER IN YOUR AREA IF PROBLEMS ARISE

CHECK THE DRAINAGE AREA TOO!

- | |
|-----------|
| 1. REMOVE |
| 2. CHECK |
| 3. CHECK |
| 4. KEEP |

mud and rubbish from the drainage area DAILY
that water can drain easily away from the pump
the fences
Cattle away

USE WASTE WATER FOR GARDENS



Raising water with different pumps

Pump handout No 2

The Zimbabwe Blair Pump

The Zimbabwe Blair Pump

The Blair Pump is a simple hand-operated pump which is used to raise water from shallow wells and tube wells around 12-15 metres deep. It is best suited for family or small group use, is affordable, easy to install and simple to operate. The working parts of the Blair Pump are made from galvanised iron and PVC (which is hardened plastic tubing of a certain size). A tool kit and a maintenance kit is supplied with the pump. Spare parts are also available, and if the pump is carefully maintained it will give good service to its users for many years.

The Zimbabwe Blair Pump was developed at Blair Research Laboratory, Harare.



Developed by Sue Laver for GTZ in collaboration with TAG/World Bank and the Ministry of Health, Masvingo Province. Illustrated by Kors de Waard.

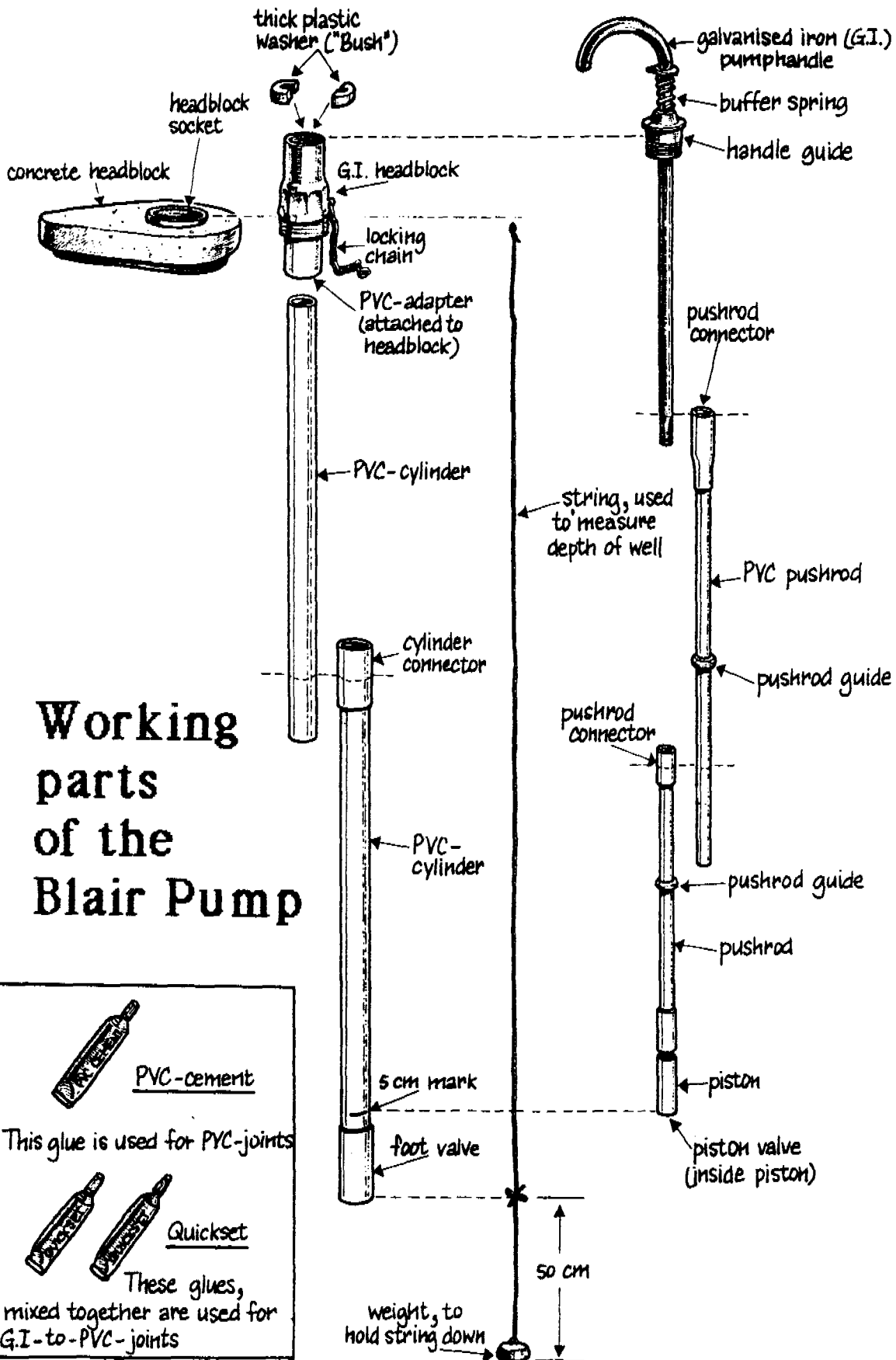

Working parts of the Blair Pump

 PVC-cement

This glue is used for PVC-joints

 Quickset

These glues, mixed together are used for G.I.-to-PVC-joints

Instructions for making and fitting the Blair Hand Pump

A Blair Pump is assembled and fitted in different stages.

1. A concrete headblock is prepared
2. The concrete headblock is fitted over the well slab or tube well
3. The depth of the well is measured carefully
4. The working parts of the Blair Pump are joined together
5. The assembled pump is lowered into the well and screwed tightly into the concrete headblock. The Blair Pump is then ready to use.

To do this follow each step carefully

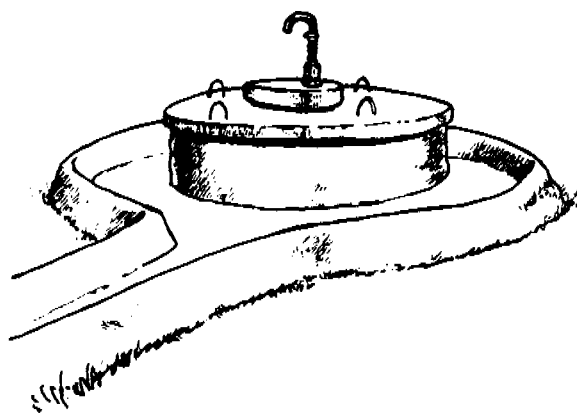

Step 1 Prepare the concrete headblock

A concrete headblock is sometimes supplied with the Blair Pump, or it can be made. The headblock is fitted onto the well slab or tube well before the pump is installed.

To make a concrete headblock

- * Use a plastic basin or similar container as a mould
- * Stand the pump **socket** in the centre of the mould
- * Make a concrete mix:
 - 1 part granite chips
 - 1 part washed river sand
 - 1 part cement
- * Pour the concrete mix around the pump socket and press down firmly
- * Add reinforcing wire cut to size for extra strength
- * Make sure that the pump socket is level and straight. It should rise 6 mm above the level of the concrete mix
- * Cover with wet sacks
- * Leave to set for at least one week

Follow instructions carefully!

Cement mix:
1 part cement
1 part sand
1 part stonechips

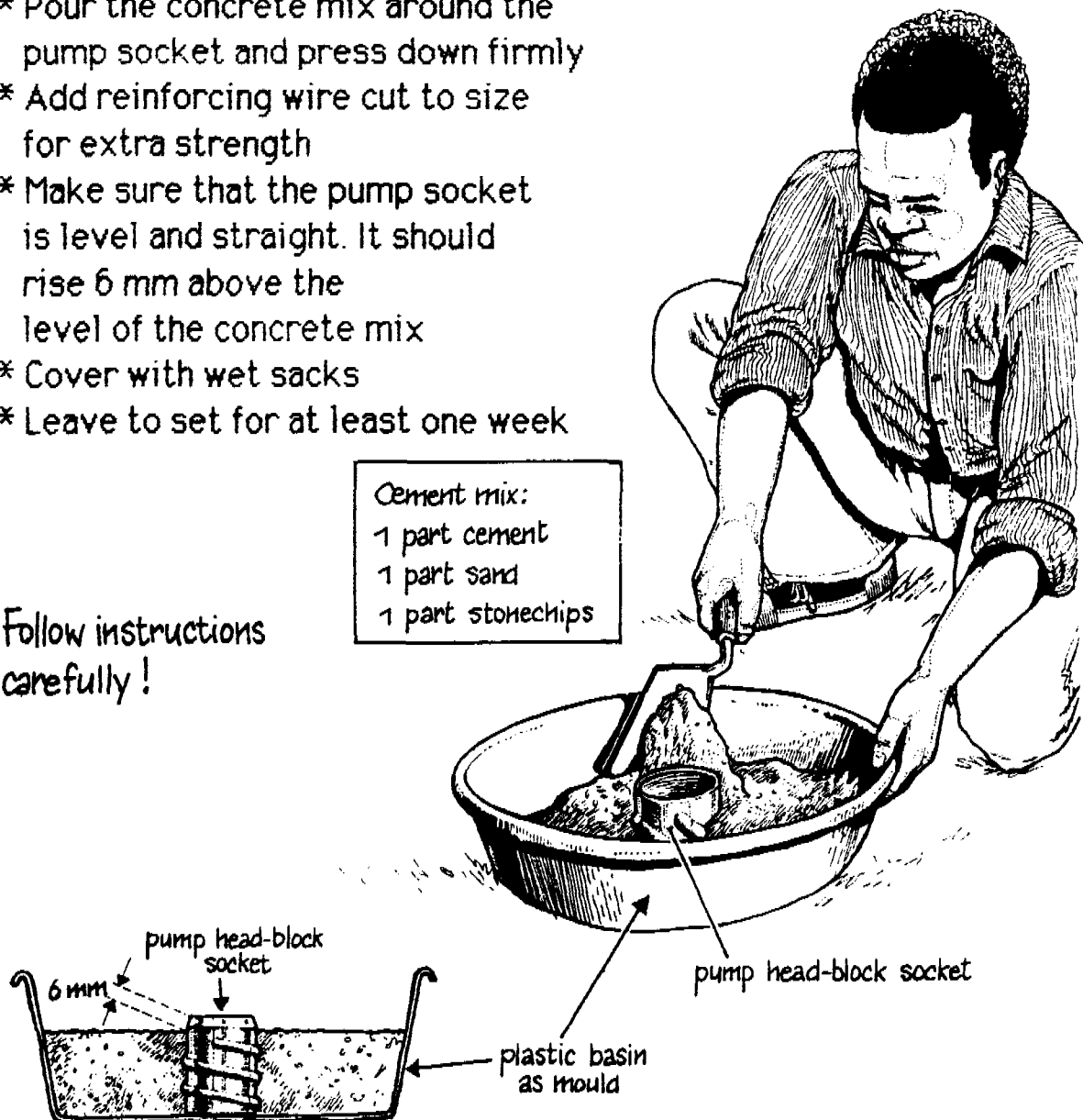

Step 2 Position the concrete headblock over the water supply

In shallow wells

The concrete headblock is lifted over the well slab and mortared in position. The pump socket inside the headblock must lie directly above the opening in the well slab.

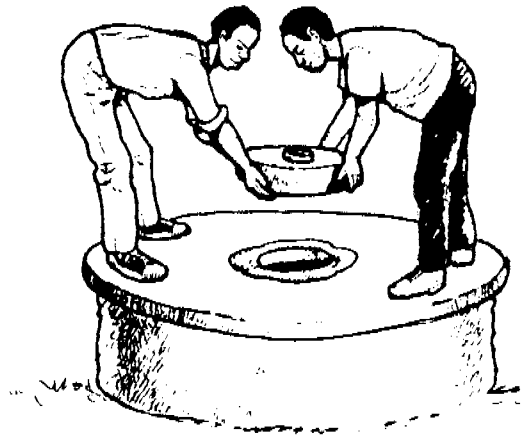

In tube wells supplied with headblock

Follow these steps so that the headblock is correctly positioned

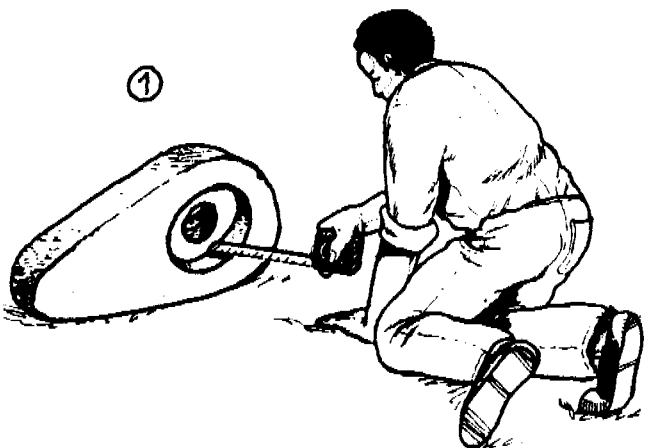

Measure the depth of the pump socket hole in the concrete headblock (approx 10cm/4inches)

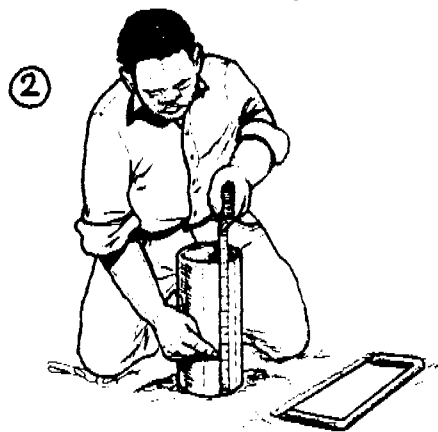

Record this measurement on the PVC casing

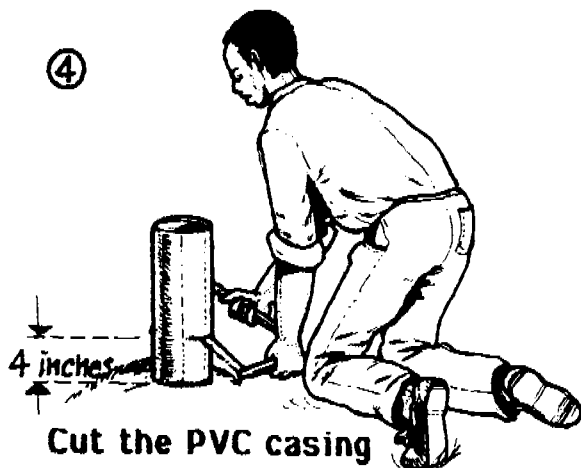

Cut the PVC casing to size



Lay cement mortar around the PVC case. Use a spirit level to position the headblock correctly. The PVC casing must fit centrally inside the headblock.

Step 3 Measure the depth of the well carefully before joining up the working parts of the Blair Hand Pump

Before the working parts of the pump are assembled, measure the depth of the well. Use the string with a weight on the end to do this. Measure from the top of the concrete headblock to the base of the well.

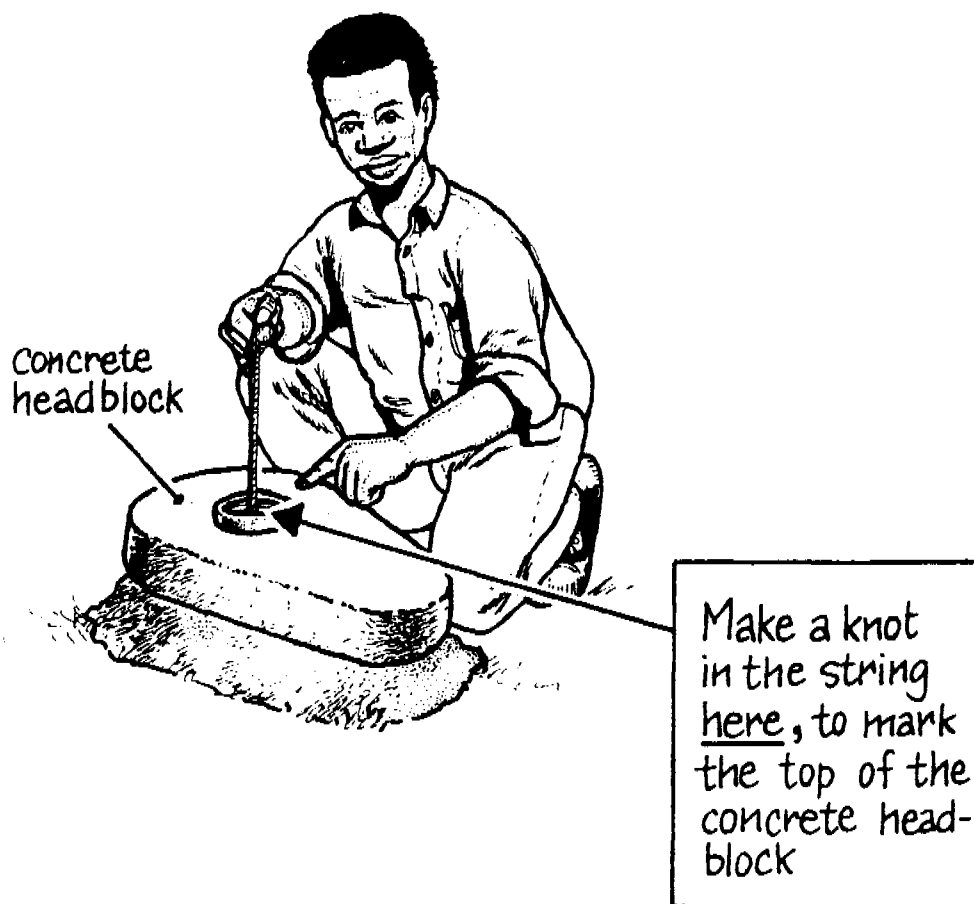

Now cut 50 cm off the total length of the string.

Lay the string and the working parts of the Blair Pump out side by side on the ground (see diagram on page 2)

Follow instructions for assembly

Step 4 Assemble the working parts of the Blair Pump

To do this:

A. Connect galvanised iron pump handle to PVC pushrod connector, (see diagram on page 2)

To do this:

- * Check that the spring and handle guide are in position
- * Glue inside of PVC pushrod and outside of pump handle connector with Trinepon 6 Quickset Glue
- * Screw pump handle into PVC pushrod tightly

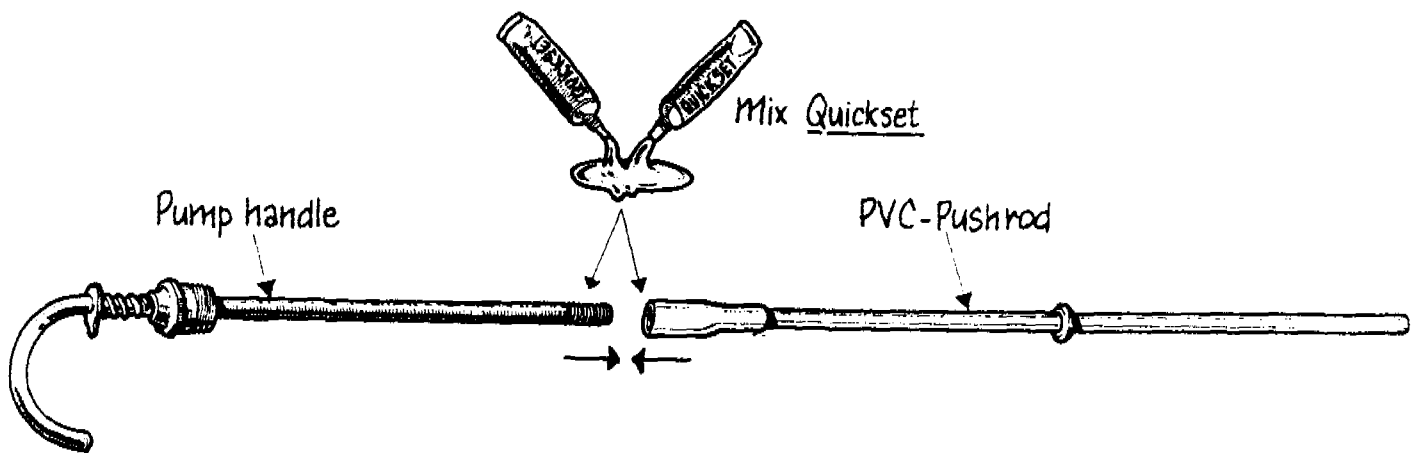

Follow these instructions for glueing together parts of the pump

- * Clean all surfaces thoroughly before glueing
- * Apply glue to the end of each joint to be connected
- * Use a screwing action to join working parts
- * Wipe off waste glue
- * Leave the parts to dry for at least fifteen minutes
- * Replace top on glue when task is completed
- * Store glue away from heat

B. Join galvanised iron headblock to PVC cylinder (see diagram on page 2)

- * Use PVC Cement for this task
- * Clean joint ends thoroughly
- * Clean away extra glue
- * Leave to dry

C. Join PVC cylinder at footvalve end

D. Make final cylinder join using a connector

To do this:

- * Measure the cylinder length exactly as shown in the picture

When completed the PVC cylinder is exactly equal in length to the string used to measure the depth of the well. (Remember that the string was shortened by 50 cm in Step 3)

The number of connectors depends on the depth of the well.

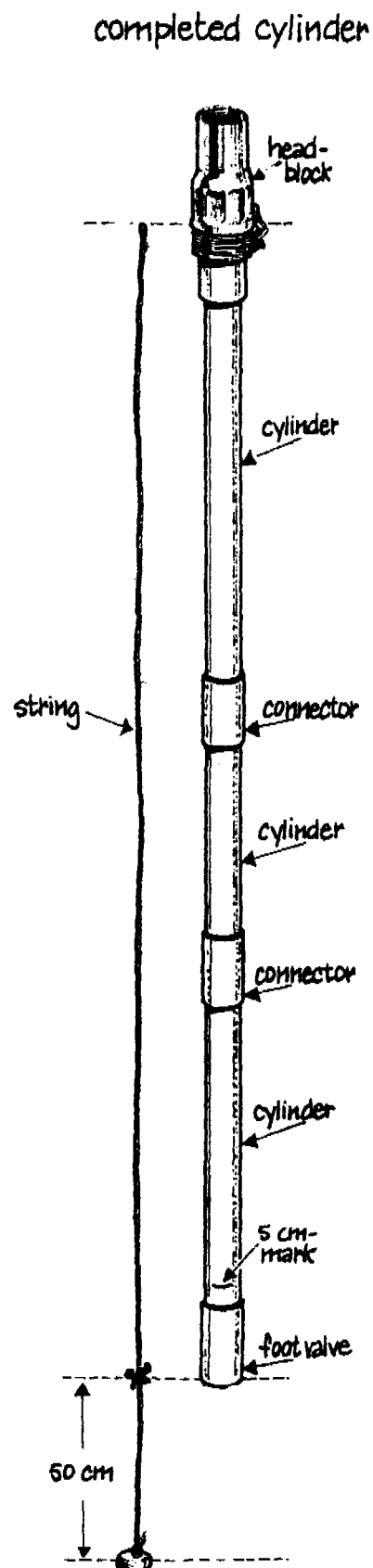

E. Make the pushrod

To do this:

- * Push the handle guide against spring of pump handle
- * Line up pushrod with cylinder exactly as shown in the diagram

It is very important to do this exactly as shown

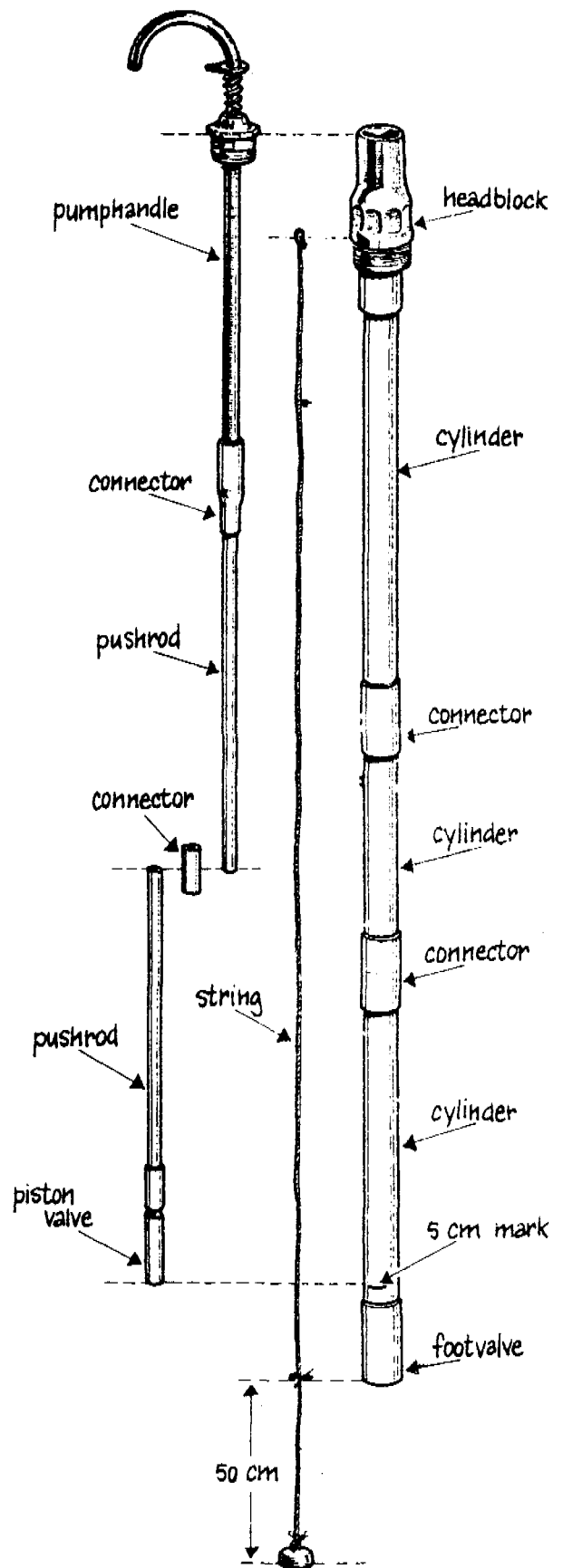

Depending on the depth of the well, you may need to use several PVC connectors to join together lengths of PVC pushrod. Use PVC glue to make the final joins.

Step 5 Fit the pump into the water supply

A. Fit the PVC cylinder through the concrete headblock into the well

To do this:

- * Remove footvalve using the spanner supplied
- * Wash the footvalve thoroughly
- * Pour water through the cylinder, turning it slowly to make sure that all dirt is removed
- * Replace footvalve and screw tight with the spanner
- * Fit the cylinder into the well
- * Screw the pumphead into the concrete headblock
- * Tighten with spanner

B. Fit pushrod through the cylinder

To do this:

- * Remove and wash piston and piston valve
- * Replace piston and piston valve
- * Install pushrod by lowering it into the cylinder

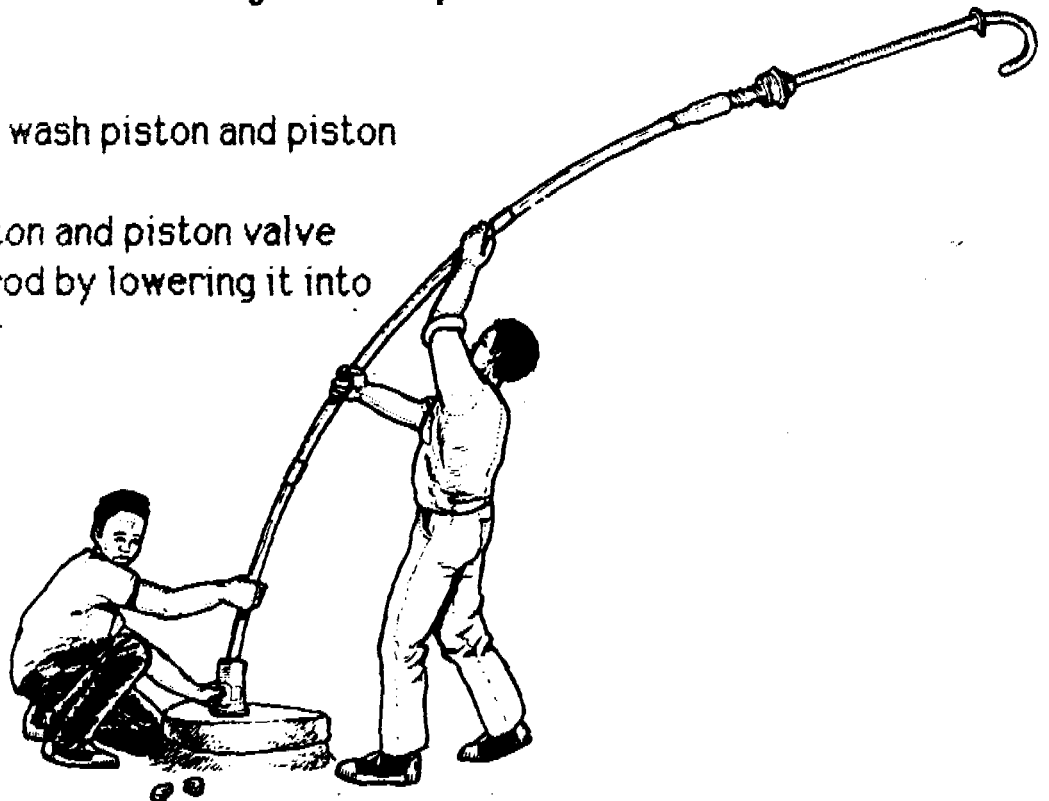

C. Fit the two halves of the nylon bushes around the pushrod inside the headblock

To do this:

- * Place 2 halves of nylon bush round top of pushrod
- * Slide the handle guide over this and screw tightly into pump headblock
- * Before tightening, test the pump. If the handle does not move freely up and down, unscrew the metal guide, change the position of the nylon bushes refit metal guide
- * Test again.
- * Tighten with spanner

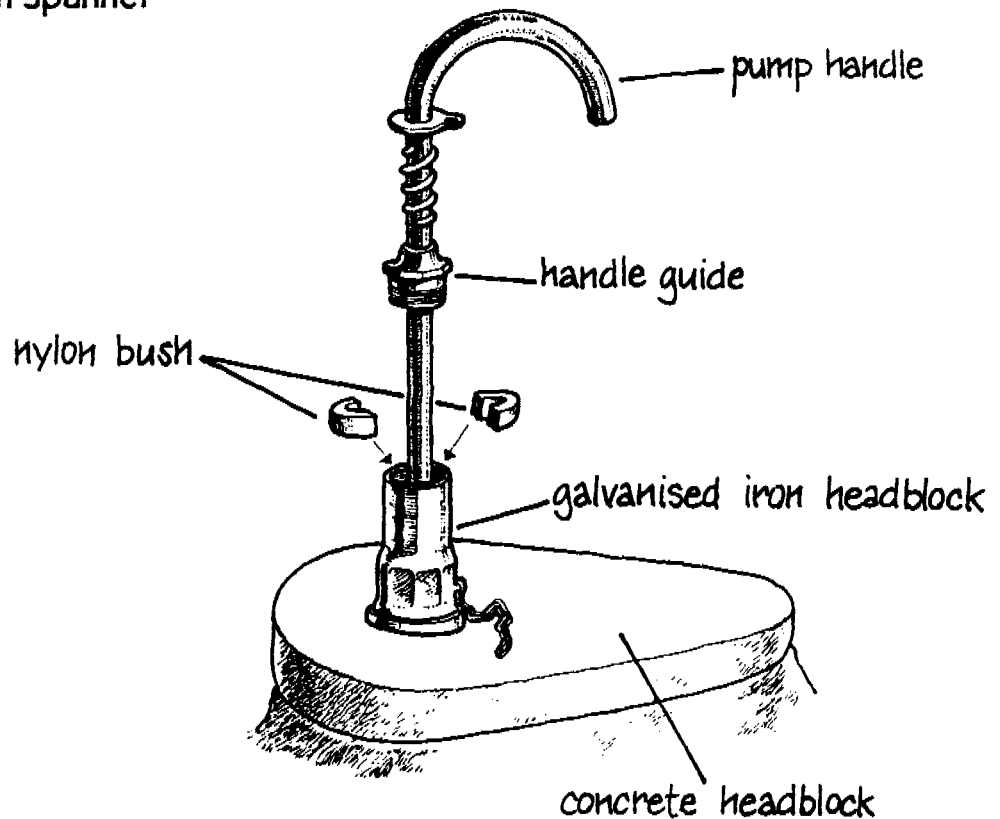

Extra information about maintaining and making minor repairs to the Blair Pump

To repair or change length of PVC pushrod or cylinder:

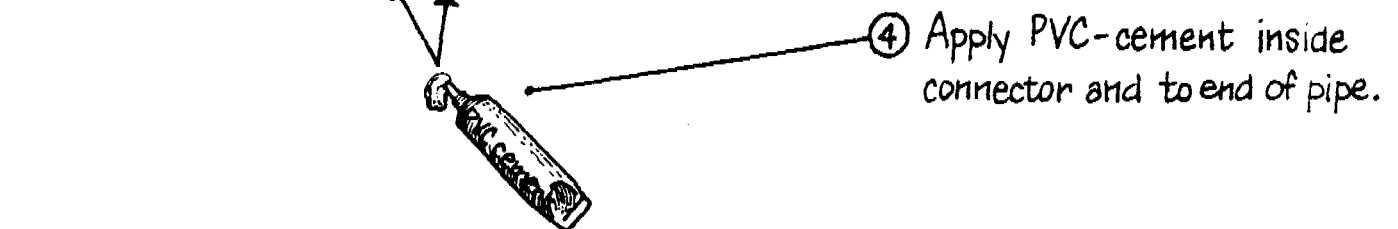
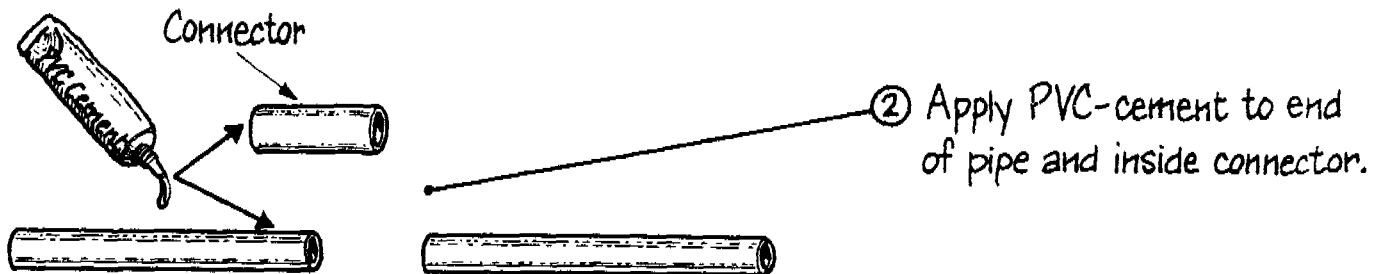
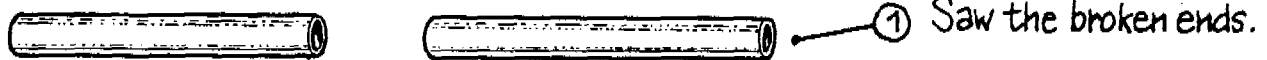
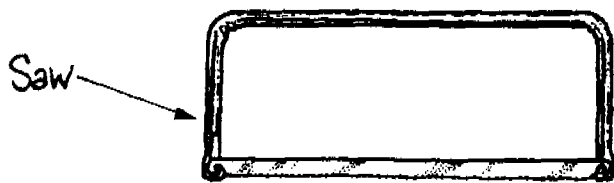
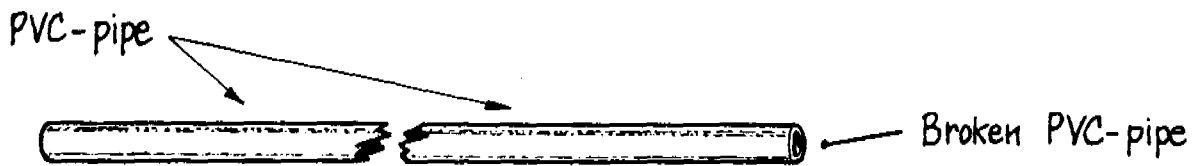

MAINTENANCE CARD

THE BLAIR PUMP

Check..... all working parts regularly

Remove..... the Blair Pump carefully

Repair..... if possible

Replace.....parts when necessary



CHECK ①

Pump headblock

- * Inspect socket
- * Replace if worn
- * Tighten

CHECK ②

Handle guide and
buffer spring

- * Inspect
- * Replace if worn

CHECK ③

Pushrod pipe

- * Remove
- * Inspect
- * Repair
- * Wash through

CHECK ④

Piston valve

- * Unscrew
- * Inspect and
wash through
- * Screw back

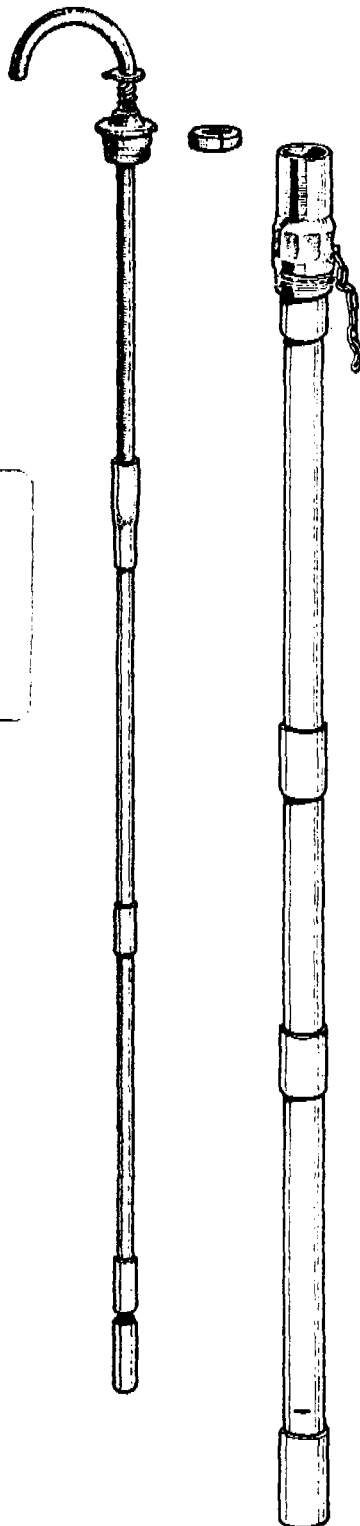

CHECK ⑤

Headblock to
PVC connector

- * Inspect

CHECK ⑥

Cylinder pipe

- * Inspect
- * Repair lengthen
or shorten
- * Wash through

CHECK ⑦

Foot valve

- * Unscrew
- * Inspect and
wash thoroughly
- * Replace if
necessary
- * Screw back on
connector

For advice on spare parts, contact the Health Inspectorate of
the provincial medical office of Health in your Province

Complete the project!

Build a drainage area around the supply!

CHECK

concrete apron

1. Water must drain easily
2. Keep free from rubbish

run-off channel and soak-away pit

1. Keep free from rubbish and mud
2. Soak-away must drain easily.

other daily checks are

1. Keep cattle away
2. prevent children playing with pump.
3. Keep area free from rubbish

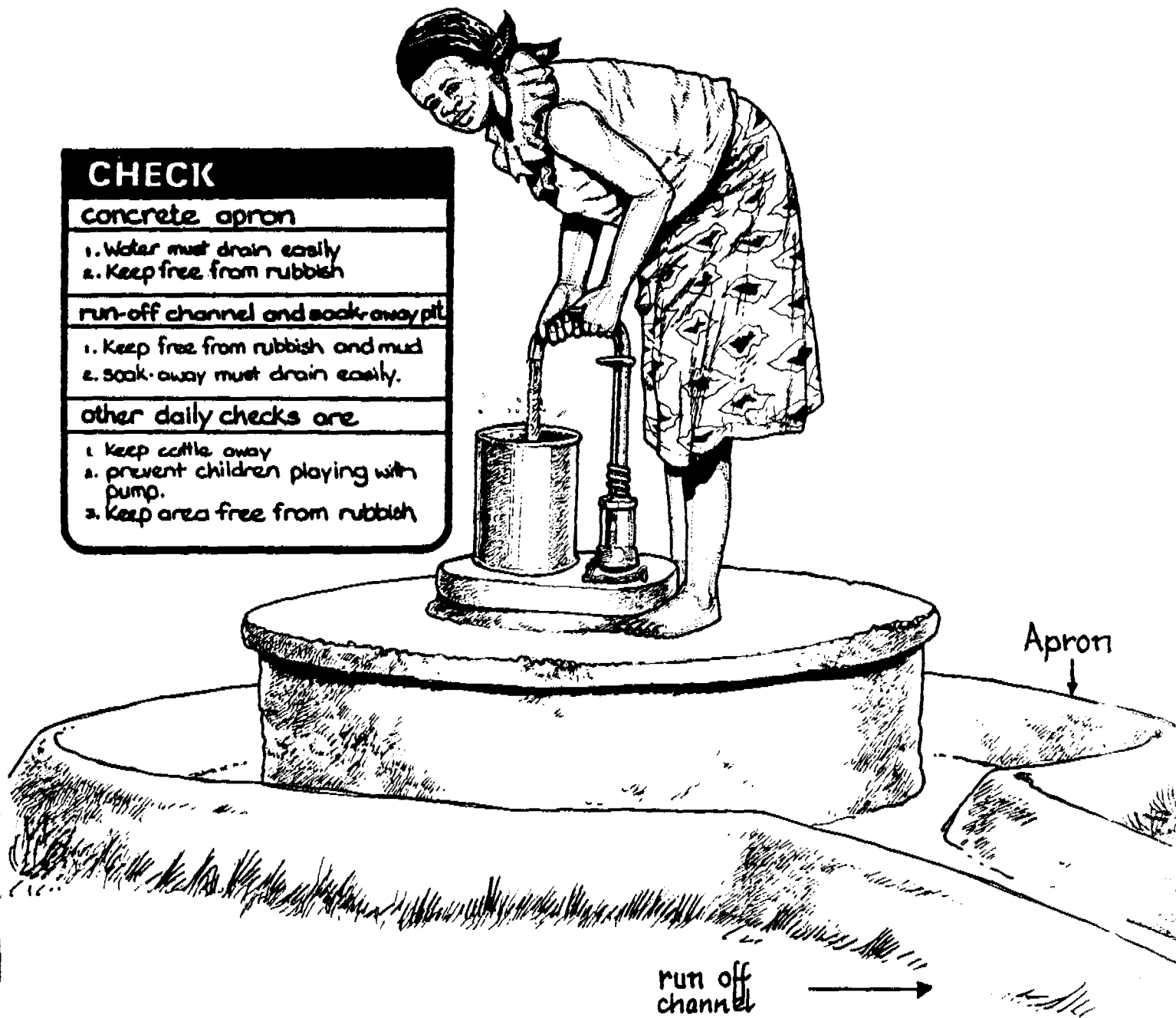

**CHECK THIS PUMP EVERY WEEK
COMPLETE YOUR CHECK BOOK EVERY TIME
SEEK THE ASSISTANCE OF THE HEALTH
WORKER IN YOUR AREA IF PROBLEMS ARISE**

The author wishes to thank the many people who have contributed to this book. Special mention must be made of all those who participated in the evaluation of the draft material.

To the Ministry of Health, the University of Zimbabwe, GTZ, and TAG — World Bank and many others, grateful thanks for encouragement and support.

Finally, to my illustrators, sincere appreciation for a job well done.

*Sue Laver
Harare, 1986*

*Sue Laver, GTZ - Consulting
Illustrations: C. Cousins, K. de Waard.*

