

2 5 2

7 5 U S



Asian Institute of Technology  
Bangkok Thailand

LIBRARY  
International Reference Centre  
for Community Water Supply

thesis No. 832

USE OF BAMBOOS AND CORRUGATED ASBESTOS CEMENT AS  
LOCAL MATERIALS FOR TUBE SETTLERS

By

Winai Liengcharernsit

Asian Institute of Technology  
Bangkok, Thailand  
1975

252-75US

II.25.10

252

75 US

USE OF BAMBOOS AND CORRUGATED ASBESTOS CEMENT AS  
LOCAL MATERIALS FOR TUBE SETTLERS

Thesis by

Winai Liengcharernsit

For the Degree of Master of Engineering

Water and Assistance Centre  
for Community Water Supply

Asian Institute of Technology

Bangkok, Thailand

1975

USE OF BAMBOOS AND CORRUGATED ASBESTOS CEMENT AS  
LOCAL MATERIALS FOR TUBE SETTLERS

by

Winai Liengcharernsit

A thesis submitted in partial fulfillment of the requirements for  
the degree of Master of Engineering of the Asian Institute of  
Technology, Bangkok, Thailand.

Approved by:

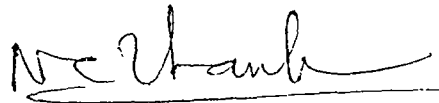

Dr. Nguyen Cong Thanh  
Assistant Professor of Environmental Engineering

May '75

Accepted by:



Dr. Milton E. Bender, Jr.  
President

22 July 75

## ACKNOWLEDGEMENTS

The author wishes to express his deep gratitude to Assistant Professor Dr. Nguyen Cong Thanh and Professor Mainwaring B. Pescod, his advisors, for their helpful guidance and advice during the course of this research. He is also thankful to Associate Professor Dr. Ping Yi Yang, a thesis committee member, and Mrs. Samorn Muttamara for her help in the laboratory work.

He is also grateful to Mr. Taweesak and all the workshop technicians for their valuable assistance in constructing the pilot plant.

He is also grateful to ESCAP for the scholarship awarded through the Asian Institute of Technology which made this work possible.

## ABSTRACT

The research was conducted at pilot plant scale to study the application of bamboo and corrugated asbestos cement as tube settlers. The parameters which affected the settling performance were studied. These included tube length, diameter, inclination angle, and rate of flow. The pilot plant consisted of a flocculation tank with mechanical mixing, chemical feeding system, and a reinforced concrete sedimentation tank. The bamboo tubes were prepared and arranged in the concrete tank. The experiments were performed with various flow conditions. Turbidity was measured to find the efficiency of removal. The test results were compared with that obtained when corrugated asbestos cement was used.

It was found that the bamboo tube settlers was efficient for turbidity removal when the flow rate was not more than  $8 \text{ m}^3/\text{hr. per sq. m.}$  of tank surface area. The removal efficiency of the tube settler with the length of 120 cm., operated at the flow rate below  $8 \text{ m}^3/\text{hr. per sq. m.}$  of tank surface area was found to be higher than 80 per cent. The tube diameter and inclination angle seemed to have less significant, however, it was found that the smallest tube gave little better results. The inclination angle was varied from 50 to 70 degrees at the interval of 10 degrees and it was found that at 60 degree inclination angle the results obtained were best.

The problems which might limit the application of bamboo as tube settlers included: The cracks along bamboo tubes; the difficulty in smoothing the inside of the tube, and odour and slime caused by digestion of organic matter from the bamboo. All these problems affected the removal of settled deposit from the tubes, and thus reduced the turbidity removal efficiency.

It was found that the removal efficiency of the settling tank with corrugated asbestos cement as tube settlers was higher than that obtained from the bamboo tube settlers. At the flow rate of  $8 \text{ m}^3/\text{hr. per sq. m.}$  of tank surface area the removal efficiency of the corrugated asbestos cement tube settlers with 120 cm. in length was found to be about 90 per cent. The inclination angle had a little effect on settling performance, however the difference in turbidity removal when the angle was varied from 50 to 70 degrees was not over 3 per cent. At the inclination angle of 50 degrees the best results were obtained. The disadvantage of the corrugated asbestos cement was its higher cost which made the construction cost increase.

## TABLE OF CONTENTS

| <u>CHAPTER</u> | <u>TITLE</u>   | <u>PAGE</u> |
|----------------|--|-------------|
|                | Title Page   | i           |
|                | Thesis Approval  | ii          |
|                | Acknowledgements                                       | iii         |
|                | Abstract   | iv          |
|                | Table of Contents                                      | v           |
| I              | INTRODUCTION   | 1           |
|                | Scope of Study   | 2           |
| II             | LITERATURE REVIEW                                      | 3           |
|                | A. Historical Developments                             | 3           |
|                | B. Basic Tube Configurations                           | 5           |
|                | (1) Horizontal Tube Settler                            | 7           |
|                | (2) Steeply Inclined Tube Settler                      | 7           |
|                | C. Physical Effects Upon the Settling Tube Performance | 7           |
|                | (1) Effect of Tube Length                              | 13          |
|                | (2) Effect of Tube Diameter                            | 13          |
|                | (3) Effect of Flow Rate                                | 13          |
|                | (4) Effect of Inclination Angle                        | 13          |
|                | (5) Effect of Raw Water Characteristics                | 14          |
|                | D. Theoretical Considerations                          | 14          |
|                | (1) Performance of an Ideal Settling Tank              | 14          |
|                | (2) Hydraulic of Inclined Tube Settlers                | 18          |
| III            | EXPERIMENTAL INVESTIGATION                             | 24          |
|                | A. Description of Pilot Plant                          | 24          |
|                | (1) Settling Tank                                      | 24          |
|                | (2) Flocculation Tank                                  | 24          |
|                | (3) Chemical Tank                                      | 29          |
|                | B. Experimental Design                                 | 29          |
|                | C. Procedure and Analytical Methods                    | 29          |
|                | (1) Preliminary Tests                                  | 29          |
|                | (2) Pilot Plant Investigation                          | 30          |
| IV             | PRESENTATION AND DISCUSSION OF RESULTS                 | 31          |
|                | A. Raw Water Characteristics                           | 31          |
|                | B. Optimum Alum Dosage and Optimum pH                  | 31          |
|                | C. Tube Settler Performance                            | 31          |
|                | (1) Effect of Tube Length on Removal Efficiency        | 48          |
|                | (2) Effect of Tube Diameter on Removal Efficiency      | 48          |
|                | (3) Effect of Inclination Angle on Removal Efficiency  | 49          |
|                | (4) Effect of Flow Rate on Removal Efficiency          | 50          |

TABLE OF CONTENTS (CONT'D)

| <u>CHAPTER</u> | <u>TITLE</u>  | <u>PAGE</u> |
|----------------|---|-------------|
|                | D. Problem in Using Bamboos as Tube Settlers                        | 51          |
|                | (1) Problem Due to Crack Along Bamboo Tube                          | 51          |
|                | (2) Space Between Bamboo Tubes                                      | 51          |
|                | (3) Smoothness of Tube Inside                                       | 51          |
|                | (4) Problem Due to Organic Matter in Bamboo                         | 51          |
|                | E. Comparison Between Bamboo Tube and Corrugated<br>Asbestos Cement | 52          |
| V              | CONCLUSION  | 53          |
| VI             | RECOMMENDATION FOR FURTHER WORK                                     | 55          |
|                | REFERENCES  | 56          |
|                | APPENDICE   | 58          |

## I INTRODUCTION

The function of sedimentation tank is to separate settleable solids from the liquid in which they are suspended. It is widely used both in water and wastewater treatment. The conventional type of settling tank is rectangular shape with length about 2-3 times of width. The depth is about 2-3 meters and the detention time is about 1-2 hours. This type of tank requires large area and high construction cost. In 1904, HAZEN proposed the theory for an ideal basin that the removal of settleable material was a function of the surface area of the basin, and was independent of the detention time and depth. He pointed out that doubling the surface area by inserting one horizontal tray would double the capacity of the basin. He felt that trays spaced at intervals as low as 1 in. would be very desirable if the problems of sludge removal could be resolved. Several shallow settling compartments were formed by a series of conical, circular trays placed one above the other. CAMP (1946) presented a design for a settling basin with horizontal trays spaced at 6 in., the minimum distance he felt was permissible for mechanical sludge removal. The basin had a detention time a 10.8 min., a velocity of 9.3 fpm., and an overflow rate of 667 gpd/sq. ft. The attempts in using settling trays met with only limited success because of two major problems: (a) the unstable hydraulic conditions with very wide, shallow trays, and (b) the minimum tray spacing was limited by the vertical clearance required for mechanical sludge removal equipment. In 1968, CULP, HANSEN, and RICHARDSON proposed that the use of very small diameter tubes with some inclination angles would overcome these problems and the detention time could be reduced to 10-15 min. This discovery reduces very much the cost of settling unit. Many researches have been done to find the most suitable values of tube-parameters such as diameter, length, and inclination angles. The tube cross-sectional area can be circular, rectangular or even hexagonal. The material used is steel, wood or PVC tubes.

In tropical countries bamboo can be found everywhere and it seems to be an attractive material for construction of circular tube settler. Because of its low cost, thus type of tube settler can be used in water treatment plant in rural area and small community.

Corrugated asbestos cement and galvanized steel are also attractive materials for tube settlers. We can make use of its shape to form a bundle of tubes. Corrugated asbestos cement seems to have an advantage over galvanized steel because it does not corrode in water.

### Purpose of the Research

This research was performed to investigate the application of bamboos and corrugated asbestos cement as tube settlers at pilot plant scale. It included the study of parameters which affected the settling performance. These parameters were tube length, tube diameter, inclination angle, water flow rate, coagulant dosage, and pH value. Turbidity was measured to find the removal efficiency. AIT Klong (canal) water was used as raw water. The settling performance of the bamboo tube settlers was compared with that of the corrugated asbestos cement tube settlers.



Scope of Research

The research was conducted in pilot plant scale. Preliminary tests were run to determine the optimum alum dosage and optimum pH value. These tests were performed both by jar-test technique and running the pilot plant. These optimum alum dosage and optimum pH value were used throughout the experiment. The length of the tube was varied from 60 to 120 cm. Three different sizes of bamboo and one size of corrugated asbestos cement were studied. The inclination angle was varied from 50 to 70 degrees. Flow system was controlled by valves so that the flocculation time was constant at 10 min. and the flow rate was varied from 4.0 to 12.0 m<sup>3</sup>/hr. per sq. m. of tank surface area. The turbidity removal efficiency was determined for each set of variables.

## II LITERATURE REVIEW

### A. Historical Developments

In 1904, Hazen suggested the idea of shallow depth sedimentation. He proposed that the percentages of sediment removed in sedimentation tank were dependent upon the area of bottom surface exposed to receive sediment, and they were entirely independent of the depth of basin; and that the best removal efficiencies were obtained when the basins were arranged so that the incoming water containing the maximum quantity of sediment was kept from mixing water which was partially clarified. He stated that as the action of a sedimentation basin was dependent upon its area and not upon its depth, one horizontal subdivision would provide two surfaces to receive sediment instead of one, and would double the amount of work that could be done. Two such divisions would treble it, and so on. He then suggested that if the basin was cut up by a series of horizontal plates into a large number of shallow passages, the increase in efficiency would be very great. However he pointed out the most serious practical difficulty that would be met in carrying out this idea, i.e. the method of cleaning because cleaning would be required much more frequently.

CAMP (1946) derived the equations that expressed the removal efficiency in terms of settling velocity, concentration of the particles, tank depth, rate of flow through the tank and mixing coefficient. He indicated the effect of turbulent mixing and reported that the removal was not absolutely independent of depth as indicated in the simple theory. However he concluded that the effect of depth was small. From his graphical solution of the equation of removal it indicated that a 50% decrease in depth would decrease the removal of discrete particles by not more than about 5% on the average; i.e. a decrease in volume of 50% through a decrease in depth might be compensated for by a 5% increase in volume through increased surface area. He concluded that for economy the depth should be made as small as was consistent with no scour. He reported that since flocculation in a settling tank produced a smaller concentration gradient, the retardation of settling due to turbulence would be even less than for discrete particles, and hence, from the standpoint of turbulent retardation of settling, shallow high-velocity tank was more economical than deep tank for both discrete and flocculent suspensions. He also presented a design for a settling basin with horizontal trays spaced at 15cm., the minimum distance he felt was permissible for mechanical sludge removal. The basin had a detention time of 10.8 min., a velocity of 4.7 cm/sec., and an overflow rate of  $1.2 \text{ m}^3/\text{hr-m}^2$ . Outlet orifices were used to distribute the flow over the width of the trays.

The practical applications of shallow tray sedimentation were limited by problems associated with distribution of flow to multiple tray units and method in removing sludge from the closely spaced trays.

FREI (1941) added three circular, steel, radial-flow trays to an existing primary sewage clarifier. He reported that the suspended solids removal increased from 41 to 61 per cent even though the flow through the tank was tripled following the addition of the trays. Some difficulty was experienced with the installation due to inadequate removal of floating sludge and scum.

Digestion of the trapped scum released gas which could not escape, and the gas pressure eventually ruptured one of the trays.

SCHMITT and VOIGT (1949) reported the use of a two story settling basin in a water treatment plant. The trays, spaced at 4.5 meters, were in series and were cleaned by draining and hand-hosing.

DRESSER (1951) reported a similar use of series trays in the Cambridge, Mass., water treatment plant. Sludge was removed from the trays, which were spaced at 1.5 meters. Each tray was drained by gravity with nozzles mounted at the end to aid in sludge removal.

CAMP (1953) again reviewed the advantages of tray settling. He discussed the tremendous functional advantages that could be realized if the sludge removal problem could be resolved so that trays with very small vertical clearances could be used.

HANSEN and CULP (1967) described some successful works of FISCHERSTORM (1955) in applying tray-settling theory. The latter pointed out the necessity of maintaining proper hydraulic conditions for efficient sedimentation and desirable overflow rates. Reports of other experiences tend to confirm his feeling that the earlier attempt to apply tray settling using radial-flow circular trays recognized only the importance of overflow rate, and neglected proper hydraulic conditions. He felt that a Reynold number of 500 (limited of laminar flow at 32°F) in the settling basin would be most beneficial to the settling process. He felt that there would be a noticeable improvement if the Reynolds number could be lowered to the laminar flow range. For a given basin, the Reynolds number can be reduced only by increasing the wetted perimeter, or inserting longitudinal baffles, horizontal or vertical, in the basin. Horizontal baffles not only decrease the Reynolds number but also reduce the overflow rate and the vertical distance settling particles must fall before striking a bottom surface, accomplishing the same goals as Hazen's tray theory in 1904. The use of vertical baffles in conjunction with horizontal baffles would reduce the Reynolds number even further. He felt that the minimum baffle spacing was limited by the sludge removal problem and the difficulty of equally distributing the flow to a large number of trays or rectangular channels. He listed several cases where he had applied his design theory in water treatment plants. The design enabled much shorter settling times than normally used. The reinforced concrete trays were generally spaced at 1.5-2.0 m. intervals. He concluded that the excellent performance of the operating installations certainly indicated that application of the tray settling concept was in no way experimental. Cost analyses showed the tray settling basins to be much less expensive than conventional basins.

HANSEN and CULP (1967) reported that the two major problems which had limited the use of shallow depth sedimentation had been overcome by using very small diameter tubes rather than wide, shallow trays. These problems were (a) the unstable hydraulic conditions encountered with very wide, shallow trays, and (b) the minimum tray spacing limited by the vertical clearance required for mechanical sludge removal equipment. They reported that longitudinal flow through tubes with a diameter of a few inches offered theoretically optimum hydraulic conditions for sedimentation. Such tubes would have a large wetted perimeter relative to the wetted area and would

thereby provide very low Reynolds numbers. They showed that even with the largest tube and highest flow rate (up to 24 cubic meters per hour per square meter of tube end area) the Reynolds number was only 96, or well below the upper limit for laminar flow of 500. They summarized that the tube configurations would meet the requirements of shallow depth, laminar flow conditions and reasonable overflow rates and the short detention times made the space-saving potential of such configurations readily apparent.

HANSEN and CULP (1967) began the tests in 1964 to evaluate the efficiency of tube configurations as sedimentation devices and to evaluate means of sludge removal. They reported that preliminary tests with single tubes of various sizes quickly demonstrated that they were efficient sedimentation devices. During these preliminary tests, they found that the accumulated sludge could be readily removed by periodically draining the tubes, if they were inclined slightly in the direction of flow. They found that an angle of inclination of 5 degrees was adequate for sludge removal by gravity. After the preliminary tests they studied the performance of inclined tubes with various length and diameter under various operating conditions. The length was varied from 0.60 m. to 2.40 m. and the diameter was varied from 1.25 cm. to 10 cm. The flow rate was varied from 5 to 20 cubic meters per hour per square meter of tube end area. Their test results showed that the turbidity removal efficiency increased as the tube length increased and decreased as the tube diameter and overflow rate increased. They also showed that the influent turbidity and polyelectrolyte dosage had an effect on the settling performance. They reported that the detention time was decreased to only 3 min. and this made the cost and space saving potential apparent. CULP and Others (1968) stated that they had, at that time, tube settling devices in operation in many water treatment plants that were providing excellent clarification with settling detention times of less than 10 minutes.

#### B. Basic Tube Configurations

CULP, HANSEN, and RICHARDSON (1968) had described two basic tube configurations shown in Fig. 2.1: (a) essentially horizontal and (b) steeply inclined. They described that the operation of the essentially horizontal tube settlers was co-ordinated with that of the filter which was used to clarify the tube settler effluent. Each time the filter backwashed the tube settler was drained completely. The falling water surface scoured the sludge deposits from the tubes and carried them to waste. The water drained from the tubes was replaced with the last portion of the filter backwash water. The tubes were inclined only slightly in the direction of flow (5 deg.) to promote the drainage of sludge during the backwash cycle. If the inclination of the tubes was increased sharply (45-60 deg.), continuous gravity drainage of the settleable material from the tubes could be achieved. The incoming solids settled to the tube bottom and then exited from the tubes by sliding downward along the tube bottom. A flow pattern was established in which the solids settling to the tube bottom were trapped in a downward flowing stream of concentrated solids. This counter current flow at solids aided in agglomerating particles into larger, heavier particles that settled against the velocity of the upwardly flowing liquid. The continuous sludge removal achieved in these steeply inclined tubes eliminated the need for drainage or

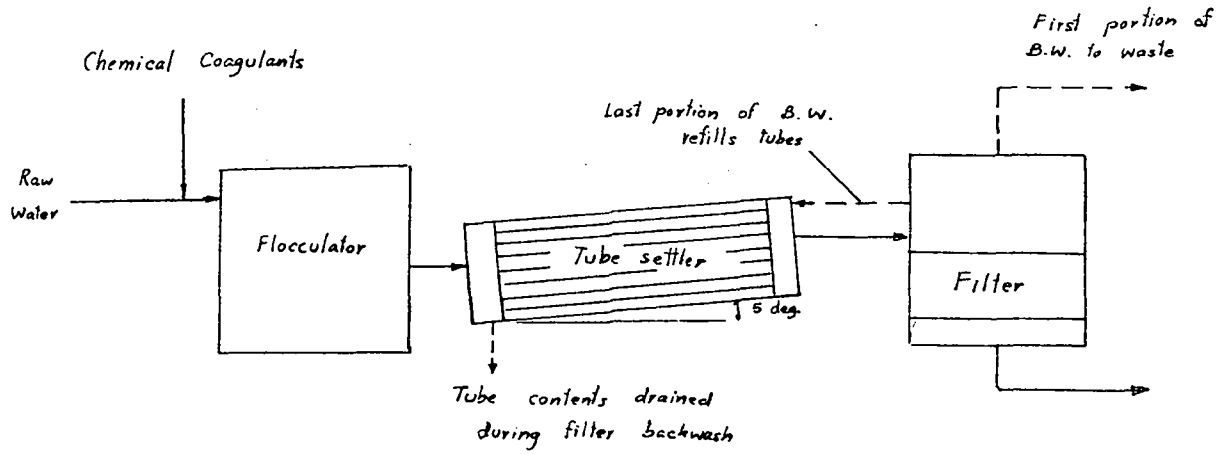

(a) Essentially Horizontal Tube Settler

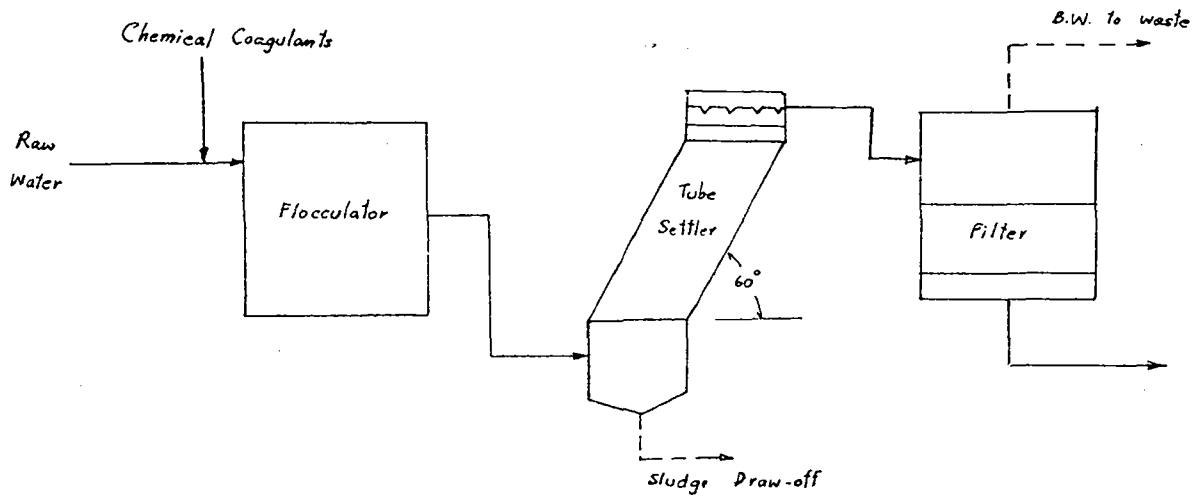

(b) Steeply Inclined Tube Settler

Fig. 2.1 Basic Tube Settler Configurations

(After CULP, HANSEN and RICHARDSON, 1968)

backflushing of the tubes for sludge removal.

(1) Horizontal Tube Settler

CULP, HANSEN and RICHARDSON (1968) reported that the essentially horizontal tube settler had been used in primary in small (2.5 m<sup>3</sup>/hr) to medium sized (1600 m<sup>3</sup>/hr) water treatment plants, where the elimination of operator attention for sludge removed from the clarifier was a significant benefit. By draining the tubes each time the filter backwashed, positive sludge withdrawal from the clarifier was achieved. The entire backwash tube drainage cycle was automated. Thus, no operator judgement on when or how much sludge to withdraw from the clarifier was required. The detention time within the tubes was about 6 minutes. Tube diameters of 2.5-5.0 cm and lengths of 0.75-1.25 m were used in most water treatment applications. Hydraulic loading rates of 7.5 to 12.5 cubic meters per hour per square meter of tube end area were generally used.

(2) Steeply Inclined Tube Settlers

They described that, in this system; the tubes were inclined at a steep angle of 45-60 degrees. The solids that settled to the bottom of an inclined tube would slide down the tube bottom continuously. This enabled sludge removal to be achieved without draining or backwashing the tubes.

C. Physical Effects Upon the Settling Tube Performance

From basic hydraulic theory the efficiency of settling tube performance will vary as the following parameters:

- 1) Tube length
- 2) Tube cross-sectional area
- 3) Raw water characteristics
- 4) Coagulant dosage
- 5) Rate of flow
- 6) Inclination angle

CULP and HANSEN (1967) had performed the tests to find the relationship between tube length and diameter, rate of flow, level of raw water turbidity, polyelectrolyte dosages, and the efficiency of turbidity removal. The apparatus they used in the test is shown in Fig. 2.2. Tube lengths of 0.65, 1.30, and 2.60 meters with diameters of 1.25, 2.50, 5.0, and 10.0 cm were studied. The tubes were projected from the inlet plenums which served to dissipate the velocity head of the incoming water and to provide a minimum of turbulence at the tube inlets. The rates of flow were controlled to the values of 5.0, 12.5, and 20.0 cubic-meters per hour per square meter of tube end area. Polyelectrolyte dosages of 0, 0.2, and 0.5 mg/l were used. Tube flow rates were checked every hour and samples of the raw water and tube settler effluent were taken at half-hour intervals. Turbidity measurements were made with a light transmittance colorimeter. The data they collected during the laboratory evaluation of tube settling parameters with different raw water turbidity are graphed on Fig. 2.4-2.9. Effects of tube length and tube diameter on settling

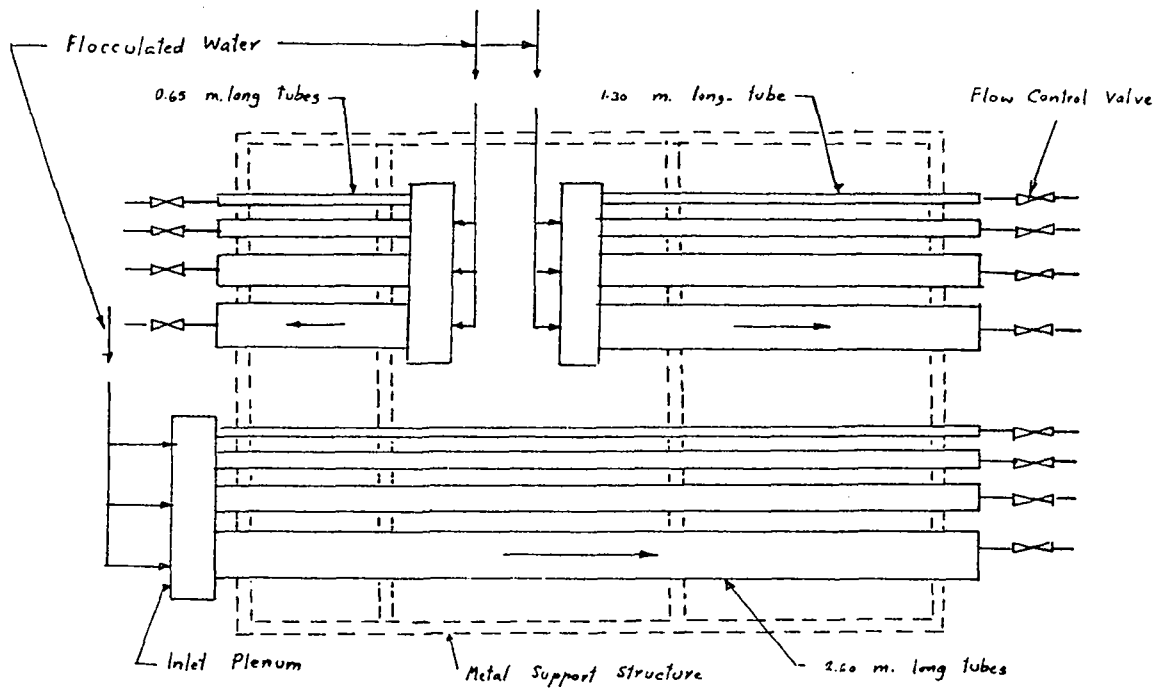

Fig. 2.2 Schematic Diagram of Culp and Hansen's Test Apparatus  
(After CULP and HANSEN, 1967)

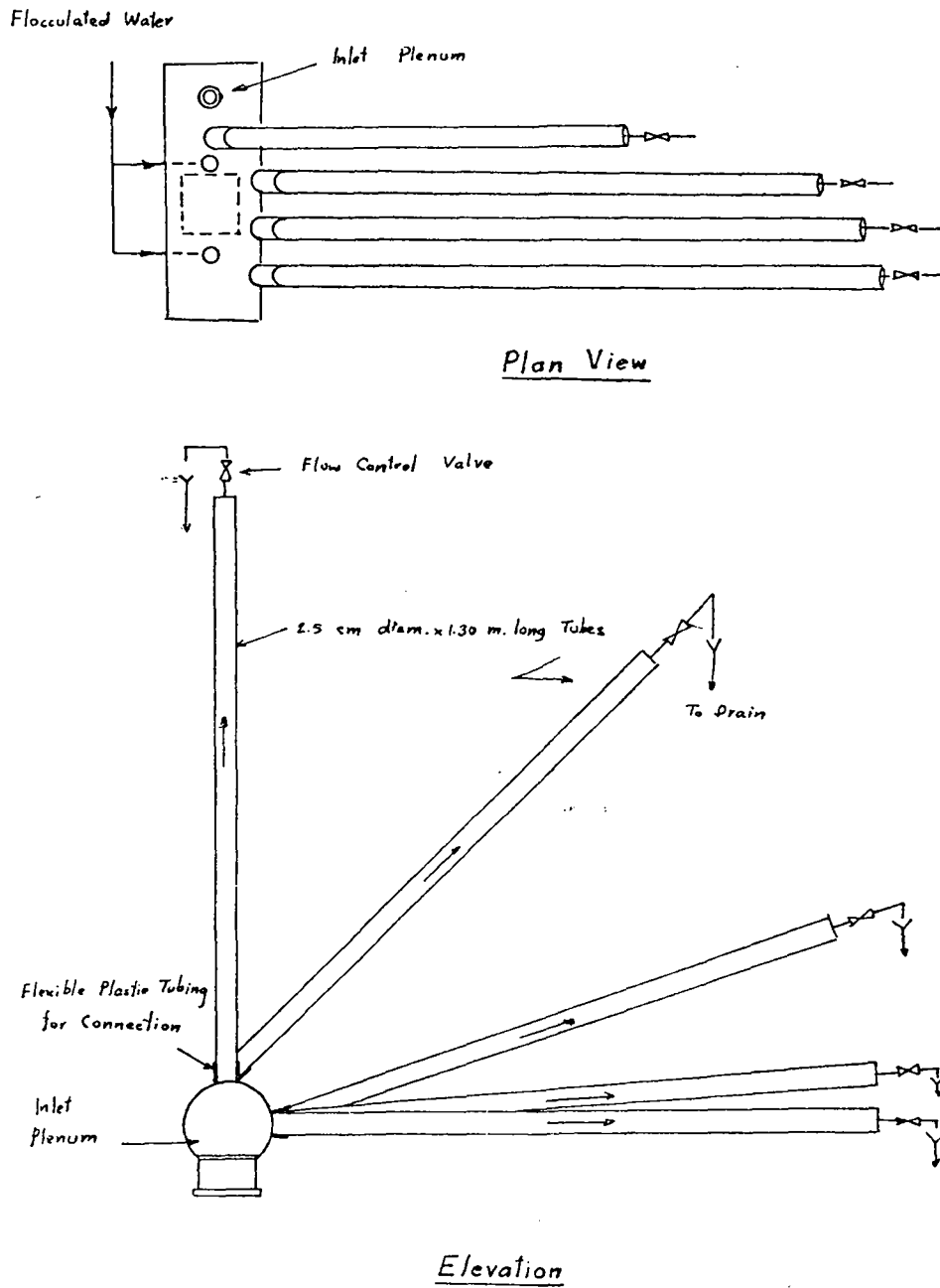

Fig. 2.3 Diagram of Test Apparatus used in Evaluating Effect of Tube Inclination. (After CULP, HANSEN & RICHARDSON, 1968)



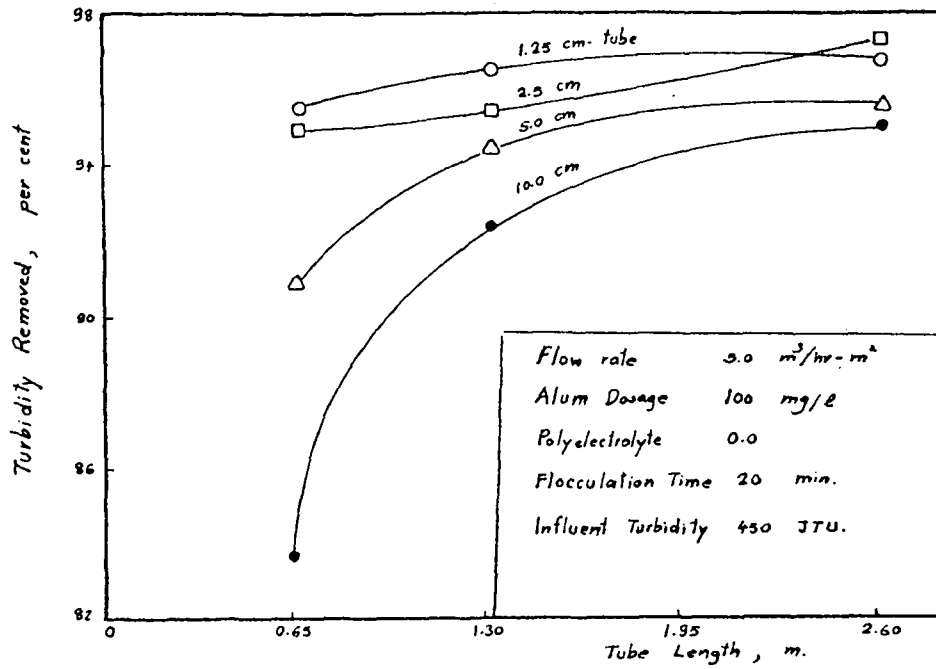

Fig. 2-4 Effect of Tube Length on Settling Performance  
 (After CULP and HANSEN, 1967)

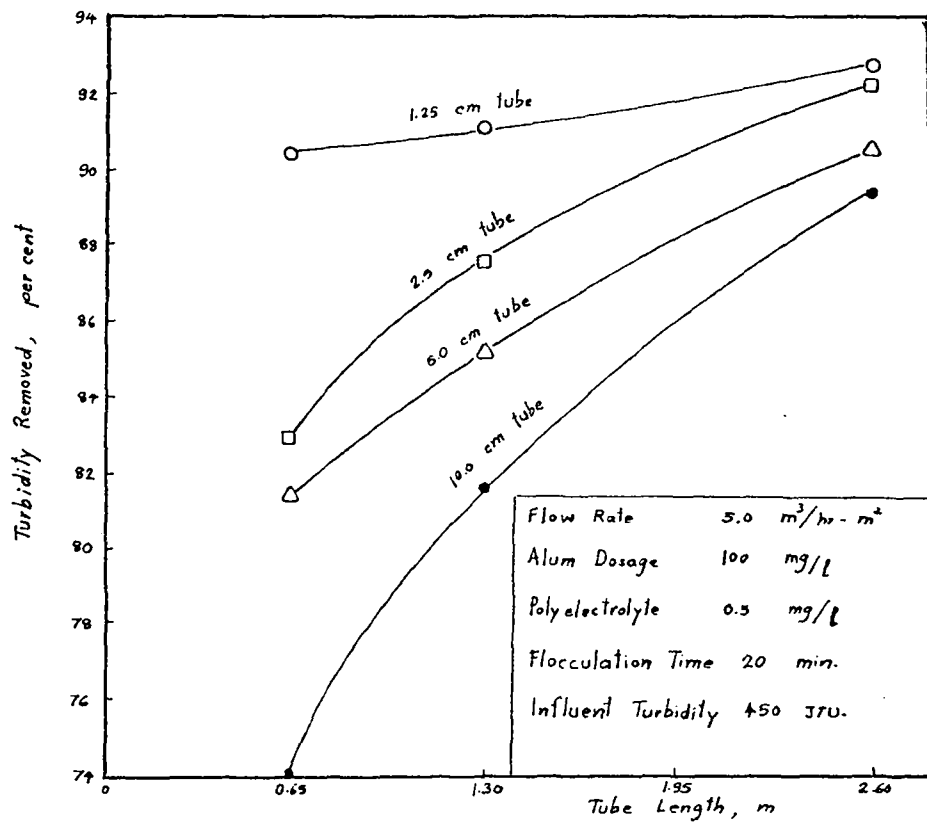

Fig 2.5 Effect of Tube Length on Settling Performance  
 (After CULP and HANSEN, 1967)

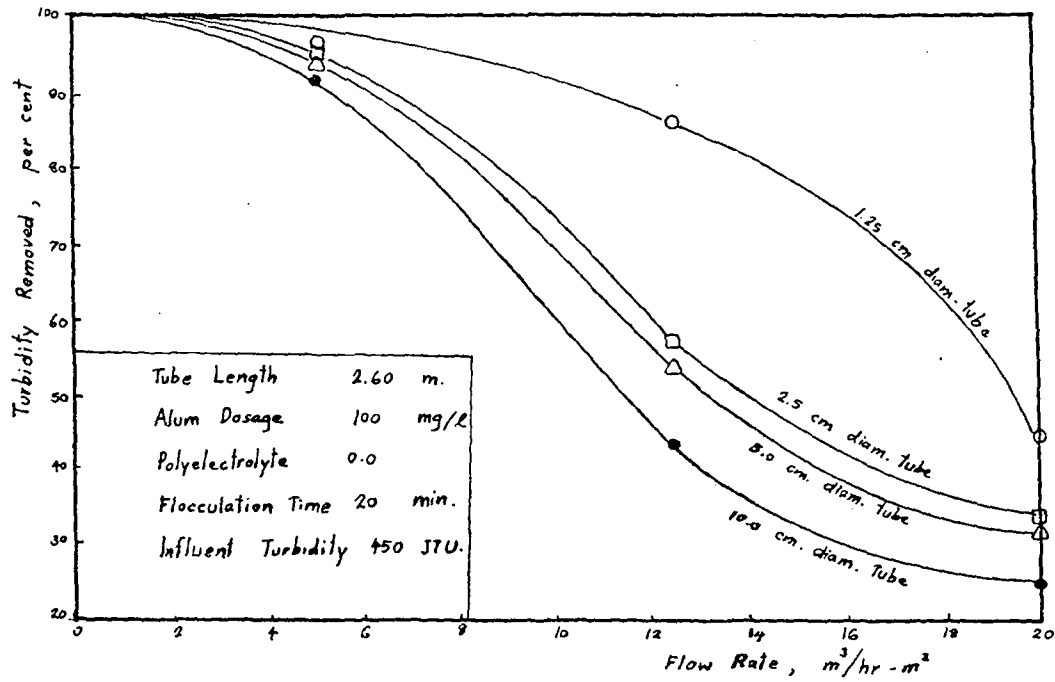

Fig. 2.6 Effect of Flow Rate on Settling Performance  
(After CULP and HANSEN, 1967)

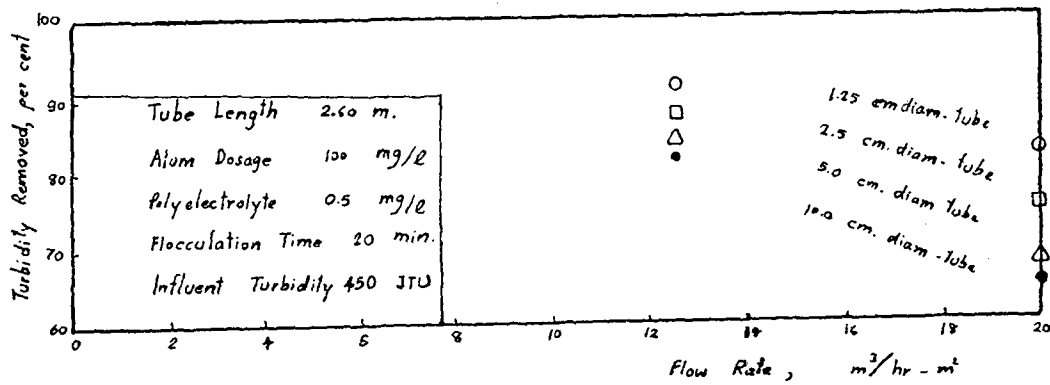

Fig. 2.7 Effect of Flow Rate on Settling Performance  
(After CULP and HANSEN, 1967)

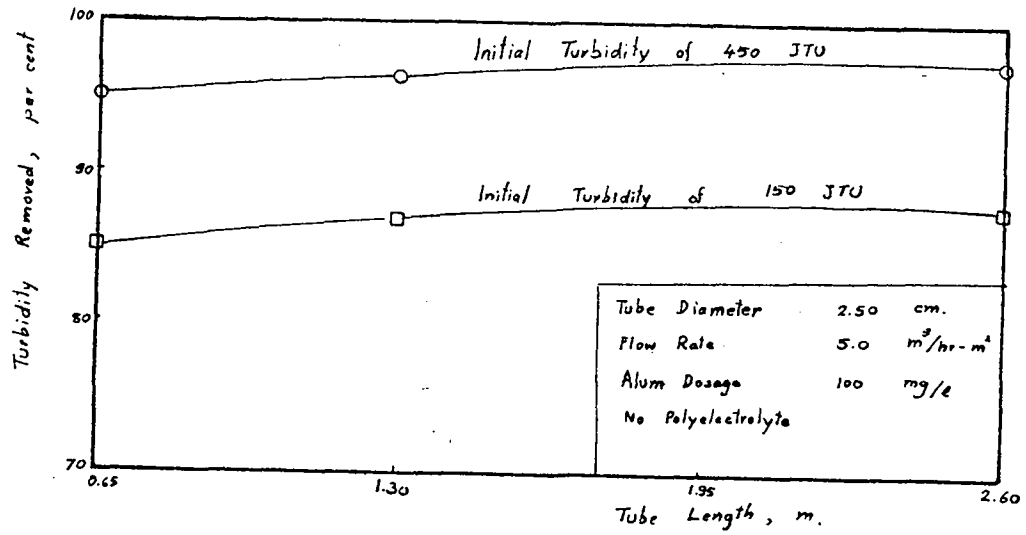

Fig. 2.8 Effect of Influent Turbidity on Settling Performance  
(After CULP and HANSEN, 1967)

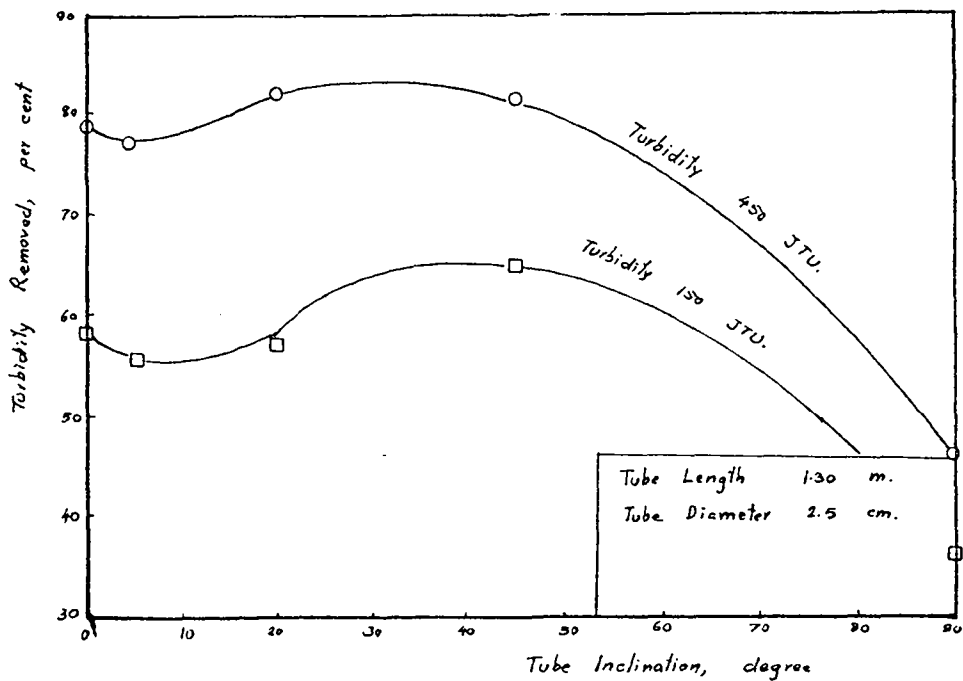

Fig. 2.9 Effect of Tube Inclination on Settling Performance  
(After CULP, HANSEN and RICHARDSON, 1968)

performance are shown by Fig. 2.4 and 2.5. Effects of flow rate and raw water turbidity are shown by Fig. 2.6-2.8.

CULP, HANSEN and RICHARDSON (1968) reported the results obtained from laboratory study in evaluating effect of tube inclination. The apparatus they used is shown in Fig. 2.8. The tests were carried out with five individual tubes inclined at angles of 0, 5, 20, 45, and 90 degrees. The tubes dimension were 1.30 m in length and 2.50 cm in diameter. The results obtained with two levels of raw water turbidity are plotted as shown in Fig. 2.9.

The results obtained from these experiments can be concluded as follows:-

(1) Effect of Tube Length

From curves shown in Fig. 2.4 and Fig. 2.5, it can be seen that the turbidity removal efficiency increases as the length of tubes increases. The difference in removal efficiency is less significant in small tube than in larger tubes. For example at flow rate of  $5.0 \text{ m}^3/\text{hr-m}^2$  with no polyelectrolyte dosage the percentages of turbidity removal for 1.25 cm-diam-tube increase from 95.8% to 96.5% while those for 10.0 cm-diam-tube increase from 82.8% to 95.8% while the lengths of the tubes increase from 0.65 m to 2.60 m (Raw water turbidity is 450 Jackson-units). The difference in removal efficiency at different length is still more significant at higher flow rate. At flow rate of  $20.0 \text{ m}^3/\text{hr-m}^2$  the percentages of turbidity removal increase from 41.0% to 68.3% for 1.25 cm-diam-tube and 18.0% to 40.5% for 10 cm-diam-tube while the lengths increase from 0.65 m to 2.6 m. When the coagulant dosage increases the percent removal increases and so the difference in removal efficiency is not so significant compared with that at low dosage.

(2) Effect of Tube Diameter

From curves shown in Fig. 2.4-2.5 it can be seen that the removal efficiency decreases as the tube diameter increases and the difference is more significant at higher flow rate than that at lower flow rate and is less significant when the coagulant dosage increases, i.e. when the floc formation is good. From Fig. 2.4 the percentage of turbidity removal is 95.8% for 1.25 cm-diam, 0.65 m length tube at flow rate of  $5.0 \text{ m}^3/\text{hr-m}^2$  while the percent-removal is 82.8 for 10 cm-diam-tube of the same length and at the same flow rate. At flow rate of  $20.0 \text{ m}^3/\text{hr-m}^2$  without polyelectrolyte dosage the turbidity removal is 41 per cent for 1.25 cm-diam, 0.65 m length tube and 18 per cent for 10 cm-diam-tube of the same length.

(3) Effect of Flow Rate

From curves shown in Fig. 2.6-2.7 the percentage of turbidity removal decreases as the rate of flow increases. The difference depends upon tube length and tube diameter. For small tube, both length and diameter, the difference in removal efficiency is less significant than larger tube.

(4) Effect of Inclination Angle

From curves shown in Fig. 2.9 the percentage of turbidity removal increases as the inclination angle increases from 0 to 45 deg. and then

decreases as the inclination angle increases beyond 45 degrees. The optimum inclination angle also depends upon the tube diameter, rate of flow, raw water characteristics and coagulation process. This is because all these parameters affect the settling velocity of solid particles and so the removal performance.

(5) Effect of Raw Water Characteristics

From the same experiment, Fig. 2.8 shows that the percentage of turbidity removal is higher for high turbid water. From the figure the percentage of removal is 95.8 per cent for the tube with the diameter of 1.25 cm and the length of 0.65 m, and at the flow rate of 5.0 m<sup>3</sup>/hr-m<sup>2</sup> and with 450 JTU raw water, while the percentage of turbidity removal equals 88 per cent for the rate tube and flow rate, but with 150 JTU raw water.

D. Theoretical Considerations

(1) Performance of an Ideal Settling Tank

FAIR, GAYER and OKUN (1968) derived the expression for the efficiency of removal of suspended particles from water flowing continuously through an idealized sedimentation tank. For convenience of discussion, they divided the tank into four zones: (1) an inlet zone, in which influent flow and suspended matter disperse over the cross-section at right angles to flow; (2) a settling zone, in which the suspended particles settle within the flowing water; (3) a bottom zone, in which the removed solids accumulate and from which they are withdrawn as underflow; and (4) an outlet zone, in which the flow and remaining suspended particles assemble and are carried to the effluent conduit (Fig. 2.10).

The processes which take place in sedimentation tank are extremely complex. There are many factors which affect the settling performance. Some of these are the particle size, density, shape; water characteristics, such as pH, solid concentration; forces between particles; scouring of bottom deposits; currents, such as eddy currents, set up by the inertia of incoming fluid, currents due to wind, different in temperature at surface and bottom, etc. So in order to construct a framework for the formulation of sedimentation in continuous flow tanks, certain simplifying assumptions must be introduced. FAIR and others (1968) assumed that:

- a) Within the settling zone, sedimentation took place exactly as in a quiescent container of the same depth.
- b) Flow was steady and, upon entering the settling zone, the concentration of suspended particles of each size was uniform throughout the cross-section at right angles to flow.
- c) Once in the bottom zone, particles settled were removed.

The paths taken by discrete particles settling in a horizontal-flow sedimentation tanks are determined by the vector sum of particle settling velocity  $v_s$  and velocity of horizontal flow  $v_d$  as shown in Fig. 2.10.

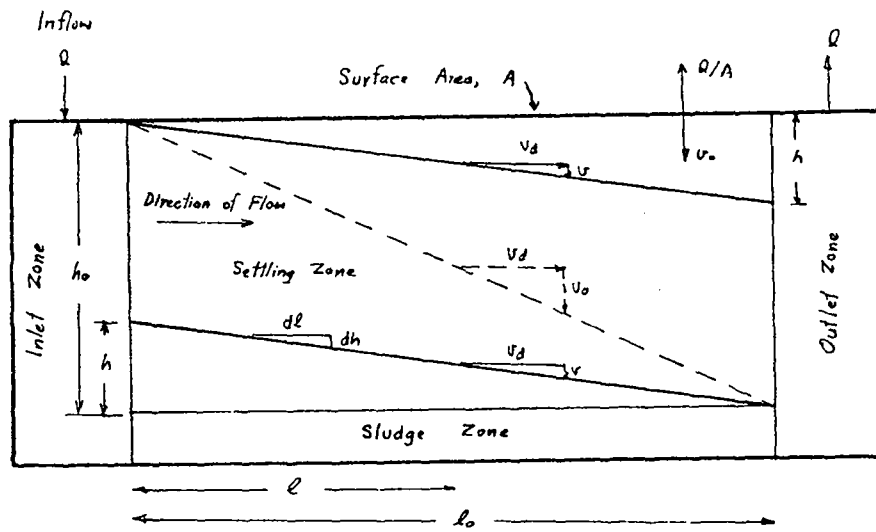

(a) Vertical Cross-section through Rectangular Sedimentation Tank

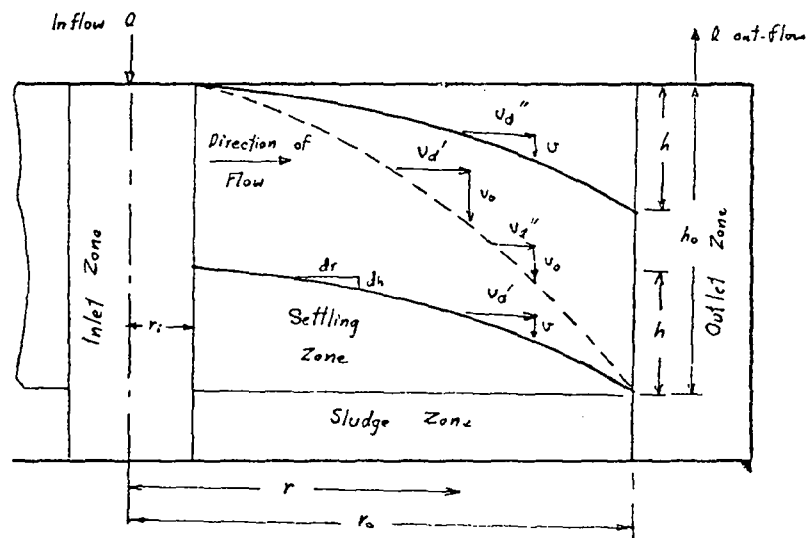

(b) Vertical Cross-section through Circular Sedimentation Tank

Fig. 2.10 Settling Paths of Discrete Particles in Horizontal Flow Tanks

(After FAIR, GEYER and OKUN, 1968)

The particles having settling velocity  $v_s \geq v_o$  are removed,  $v_o$  being the velocity of the particle falling through the full depth  $h_o$  of the settling zone in the detention time  $t_o$ . Also  $v_o = h_o/t_o$ ,  $t_o = C/Q$ , and  $C/h_o = A$ , where  $Q$  is the rate of flow,  $C$  the volumetric capacity of the settling zone, and  $A$  its surface area. Therefore  $v_o = Q/A$  is the surface loading or overflow velocity of the basin. In vertical-flow basins, particles with velocity  $v_s < v_o$  do not settle out. By contrast such particles can be removed in horizontal-flow tanks if they are within vertical striking distance  $h - vt_o$  from the sludge zone. If  $y_o$  particles possessing a settling velocity  $v_s \leq v_o$  compose each size within the suspension, the proportion  $y/y_o$  of particles removed in a horizontal-flow tank becomes

$$y/y_o = h/h_o = (v_s t_o)/(v_o t_o) = v_s/v_o = v_s/(Q/A)$$

These relationships follow also from the geometry of Fig. 2.10.

For rectangular basin of width  $b$ ,  $dh/dl = (v_s dt)/(v_d dt) =$  constant because both  $v_s$  and  $v_d$  are constant. Hence  $h = (v_s/v_d)l$ , and  $h/h_o = (v_s/v_d)(l/h_o) = (v_s lb)(v_d h_o b) = v_s/(Q/A)$  as before. For a circular basin of radius  $r$ ,  $v_d = Q/(2\pi r h_o)$  is variable, and  $dh/dr = v_s/v_d = 2\pi r h_o v_s/Q$  or  $h/h_o = v_s (r_o^2 - r_i^2)/Q = v_s/(Q/A)$  once again.

The ratio of particles removed in this sedimentation tank can be expressed as

$$\frac{y - y_o}{y} = \frac{(Q/A) - v_s}{v_s}$$

The ratio of particles which do not settle in the tank to the total amount of particles can be expressed as

$$\frac{y_o}{y} = \frac{Q/A}{v_s}$$

It can be seen that the efficiency of particle removal is not affected by the depth of the tank. If the tank is divided into two compartments with a horizontal plates and the total flow rate is kept constant the rate of flow in each compartment will be one half the total flow rate and so, from the expression above, the non-settled particles will be reduced to one half of the previous value.

CAMP (1946) presented the expression for removal of particles as a function of suspended matter concentration along the total length of settling zone. The concentration of suspended matter at any points in the tank will be different. The distribution of the suspended matter concentration in any vertical column in an ideal basin will be in precisely the same manner as in the quiescent settling analysis after an equal period of settling. Camp suggested that the settling analysis might be used to predict the concentration at any points in the settling zone. If the settling velocity analysis of the original suspension is presented by a curve such as Fig. 2.11, the value of  $C_r$ , suspended matter concentration,

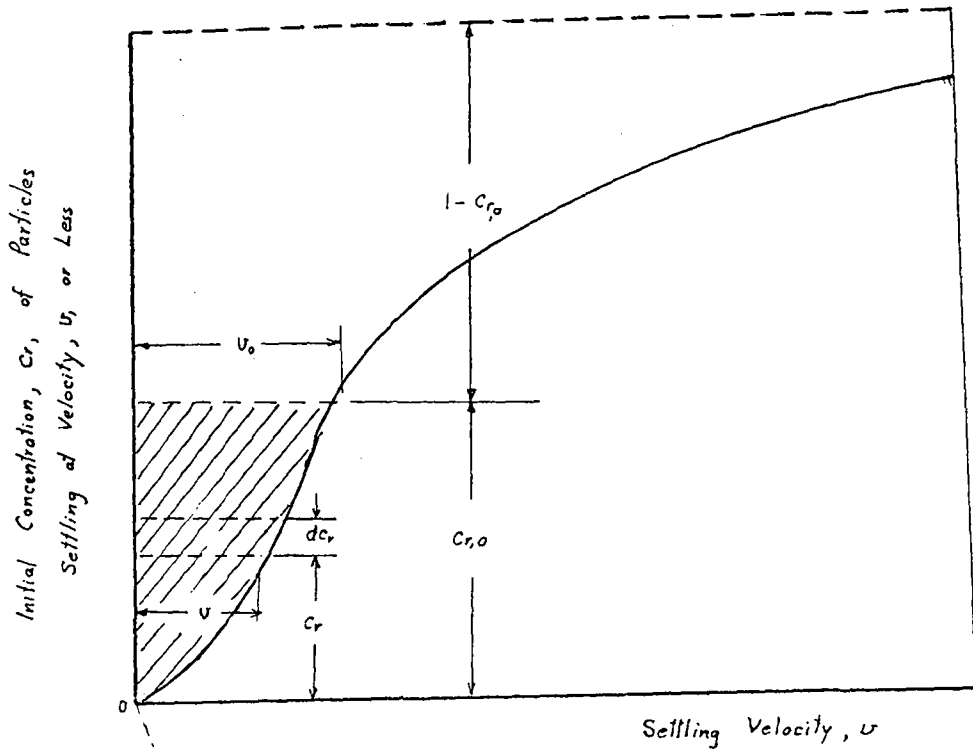

Fig. 2.11 Typical Settling Velocity Analysis Curve of Suspension for Discrete Particles

(After CAMP, 1946)



corresponding to the overflow rate  $v_0$  of the tank may be read from the curve. The removal of particles having any settling velocity  $v$  which is less than  $v_0$  is  $r_r = \frac{v}{v_0} = v/(Q/A) = \frac{bLv}{Q}$ , where  $b$  is the tank width and  $L$  the length. The amount of particles of which  $v < v_0$  which are removed is equal to the change in the concentration of the particles in water. The total removal of all particles is

$$r_r = (1 - C_{r,o}) + \frac{1}{v_0} \int_0^{C_{r,o}} v \, dC_r$$

where

$(1 - C_{r,o})$  is the removal of particles of which  $v > v_0$  in terms of the total suspension.

The term  $\frac{1}{v_0} \int_0^{C_{r,o}} v \, dC_r$  is the average vertical distance from the curve (Fig. 2.11) to the horizontal line for  $C_r = C_{r,o}$ . It is the shaded area in Fig. 2.11 divided by  $v_0$ .

## (2) Hydraulic of Inclined Tube Settlers

YAO (1970) conducted the basic theoretical research on the characteristics of the tube settlers and the governing physical properties of tube settling system. He stated that in the small conduits laminar flow might develop and the velocity distribution could be quite different from uniform, and so, the particle paths were not straight lines. Hence the expressions for tube settler performance derived by Yao are different from those derived by Camp. With Camp's model, the overflow rate of a settling tank expressed in rate of flow per unit tank area represents the critical fall velocity of the suspended particles. Theoretically, suspended particles with fall velocities greater than or equal to this critical value will be completely removed in the tank. YAO (1970) stated that the difficulties had arisen here, i.e. (1) no information was available whether the parameter overflow rate still remains the same physical significance for settlers other than those rectangular in shape; (2) nothing was known as to how to calculate the overflow rate for settlers such as inclined circular tubes. He suggested that Camp's model was in need of extensive generalization if it was to be applied to inclined tube settlers. For evaluating the tube-settler performance he used the coordinate system as shown in Fig. 2.12 for study. He derived the following equation to determine the particle path:

$$\frac{dy}{dx} = \frac{-v_s \cos \theta}{u - v_s \sin \theta} \quad (2.1)$$

where  $x$  and  $y$  are the coordinates in the X and Y directions, respectively,  $v_s$  is the settling velocity,  $\theta$  the inclination angle,  $u$  the velocity of flow. This equation is the differential equation of the particle trajectory resulting from the combined effects of fluid drag and gravitational settling. YAO (1970) also gave the general equation of the particle trajectory which was derived from the above differential equation,

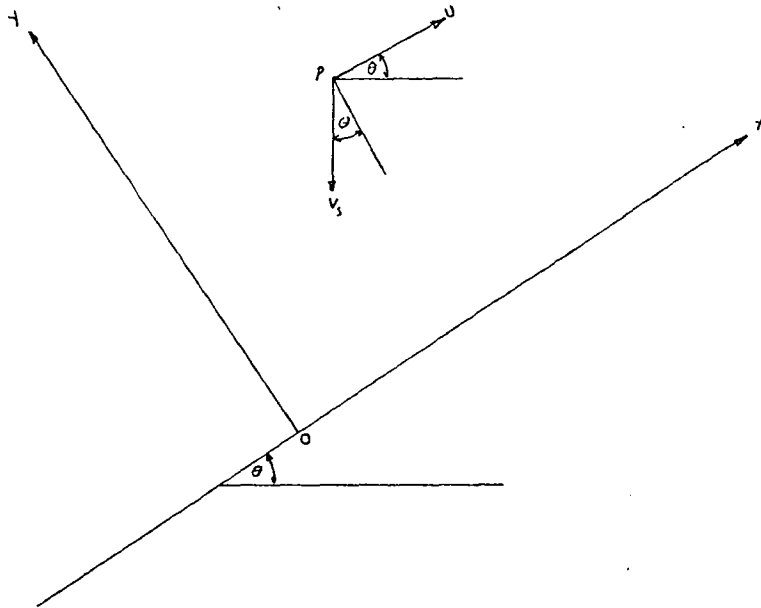

Fig. 2.12 Coordinate System

(After YAO, 1970)

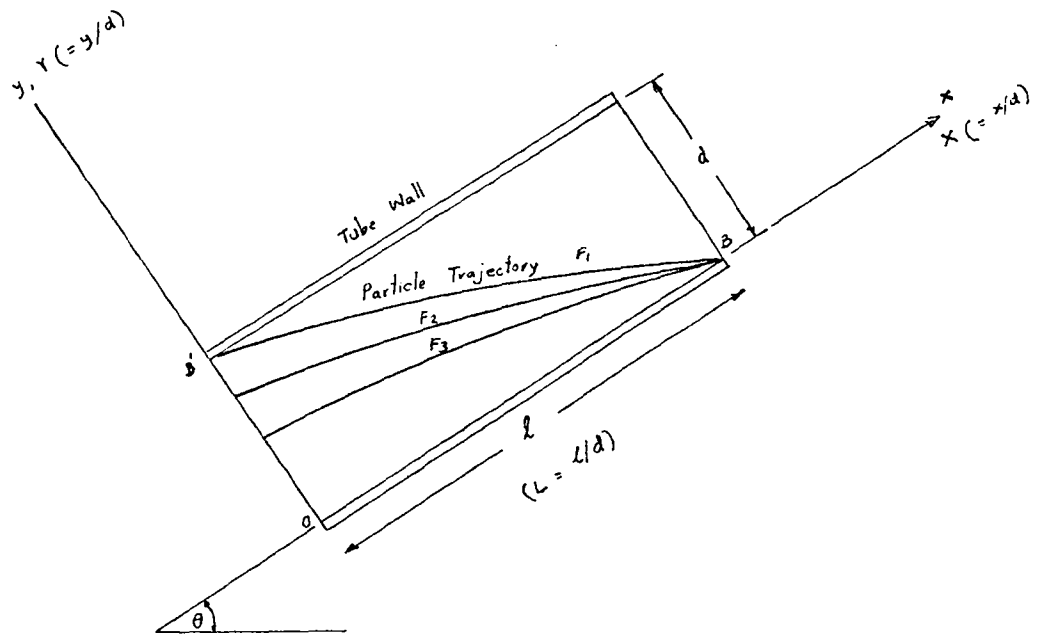

Fig. 2.13 High Rate Settling System using a Circular Tube Settler

(After YAO, 1970)

That is: 
$$\int \frac{u}{v_o} dY - \frac{v_s}{v_o} Y \sin \theta + \frac{v_s}{v_o} X \cos \theta = C_1 \quad (2.2)$$

where  $v_o$  is the average flow velocity  
 $C_1$  is the adjusted integration constant  
 $Y = y/d, X = x/d$   
 $d$  = the depth of flow measured normal to the direction of flow.

$C_1$  and  $\int \frac{u}{v_o} dY$  can be evaluated for a particular particle trajectory in a given high rate settling system.

YAO also introduced a parameter S which he expected that it would characterize the performance of tube settlers. This parameter S is expressed as

$$S = \frac{v_s}{v_o} (\sin \theta + L \cos \theta) \quad (2.3)$$

where  $v_s$  = settling velocity of suspended particles  
 $v_o$  = average velocity of flow through tube settlers  
 $\theta$  = tube inclination angle  
 $L$  = the relative length of the settler.

YAO defined the critical particle fall velocity,  $v_{sc}$ , as the velocity of particles which have a limiting trajectory, that is, the trajectory that starts at the top point of the tube at its entrance end, and passes the bottom point of the tube at its exit. This trajectory represents the uppermost trajectory in the family. Any suspended particle with its fall velocity greater than or equal to this critical fall velocity  $v_{sc}$  would be completely removed in the settler. If  $v_s$  in Eq. 2.3 is substituted by  $v_{sc}$ , the critical S-value,  $S_c$ , will be obtained. Yao had reported the critical S-value for each type of cross-section and he stated that any suspended particle in such a system with its S-value greater than or equal to the critical S-value for that system would be completely removed. The critical S-values of any types of cross-section area are as follows:

Circular Tube Settlers  $S_c = \frac{v_{sc}}{v_o} (\sin \theta + L \cos \theta) = \frac{4}{3} \quad (2.4)$

Square Conduits  $S_c = \frac{v_{sc}}{v_o} (\sin \theta + L \cos \theta) = \frac{11}{8} \quad (2.5)$

Shallow Open Tray  $S_c = \frac{v_{sc}}{v_o} (\sin \theta + L \cos \theta) = 1 \quad (2.6)$

Uniform Flow  $S_c = \frac{v_{sc}}{v_o} (\sin \theta + L \cos \theta) = 1 \quad (2.7)$

Overflow Rate

This is one of the most important parameters which affect the settling performance. In horizontal rectangular tank the overflow rate is defined as the total flow rate divided by the surface area, (Overflow rate = Q/A). This value is equal to the critical fall velocity  $v_{sc}$  of

the particle. In tube settling system the expression for the overflow rate is different because the particle trajectory is different. YAO (1970) adapted the critical fall velocity concept to the tube settling systems. He estimated the overflow rate ( $= v_{sc}$ ) from the critical S-value. He presented the expression for overflow rate as follows:

$$\text{Overflow rate } (= v_{sc}) = CK \frac{v_o}{L} \quad (2.8)$$

where

$$K = S_c \frac{L}{\sin \theta + L \cos \theta} \quad (2.9)$$

where C is a constant and its magnitude depends on the units used. In British units with  $v_o$  in fps and overflow rate in u.S. gpd/sq ft,  $C = 6.54 \times 10^5$ . In metric units with  $v_o$  in cm/sec and overflow rate in cu m/day/sq m,  $C = 8.64 \times 10^2$ .

#### Influence of Relative Length L on Settling Performance

YAO (1970) also indicated theoretically the influence of relative length on settling performance. From his previous expression,  $\frac{v_{sc}}{v_o} = \frac{S_c}{\sin \theta + L \cos \theta}$  the curve of  $\frac{v_s}{v_o}$  plotted against L is shown in Fig. 2.14. YAO indicated by this curve that suspended particles with much smaller fall velocity were removed completely as L increased. He showed that the rate of decrease in  $v_{sc}$  dropped appreciably after L reached 20 and became rather insignificant with L greater than 40. Hence L should be kept below 40 and preferably around 20.

#### Influence of Inclination Angle on Settling Performance

YAO (1970) showed that the relationship between inclination angle,  $\theta$ , and relative length, L that gave the maximum removal efficiency could be expressed as:-

$$\theta = \tan^{-1} \frac{1}{L}$$

From this relationship and the expression  $\frac{v_s}{v_o} = \frac{S_c}{\sin \theta + L \cos \theta}$  the variation of settler performance with  $\theta$  at different values of L is shown in Fig. 2.15. In this figure the ratio of  $v_{sc}$  at  $\theta = \theta$  to  $v_{sc}$  at  $\theta = 0^\circ$  is plotted against  $\theta$  for each value of L. It can be seen from the figure that the performance of the settler deteriorates rapidly after  $\theta$  reaches about  $40^\circ$ , this is indicated by the rapid increase in  $v_{sc}$ . Fig. 2.15 also shows that there is little change in performance when L is increased from 30 to  $60^\circ$  and systems having larger L tend to be more sensitive to change in  $\theta$ .

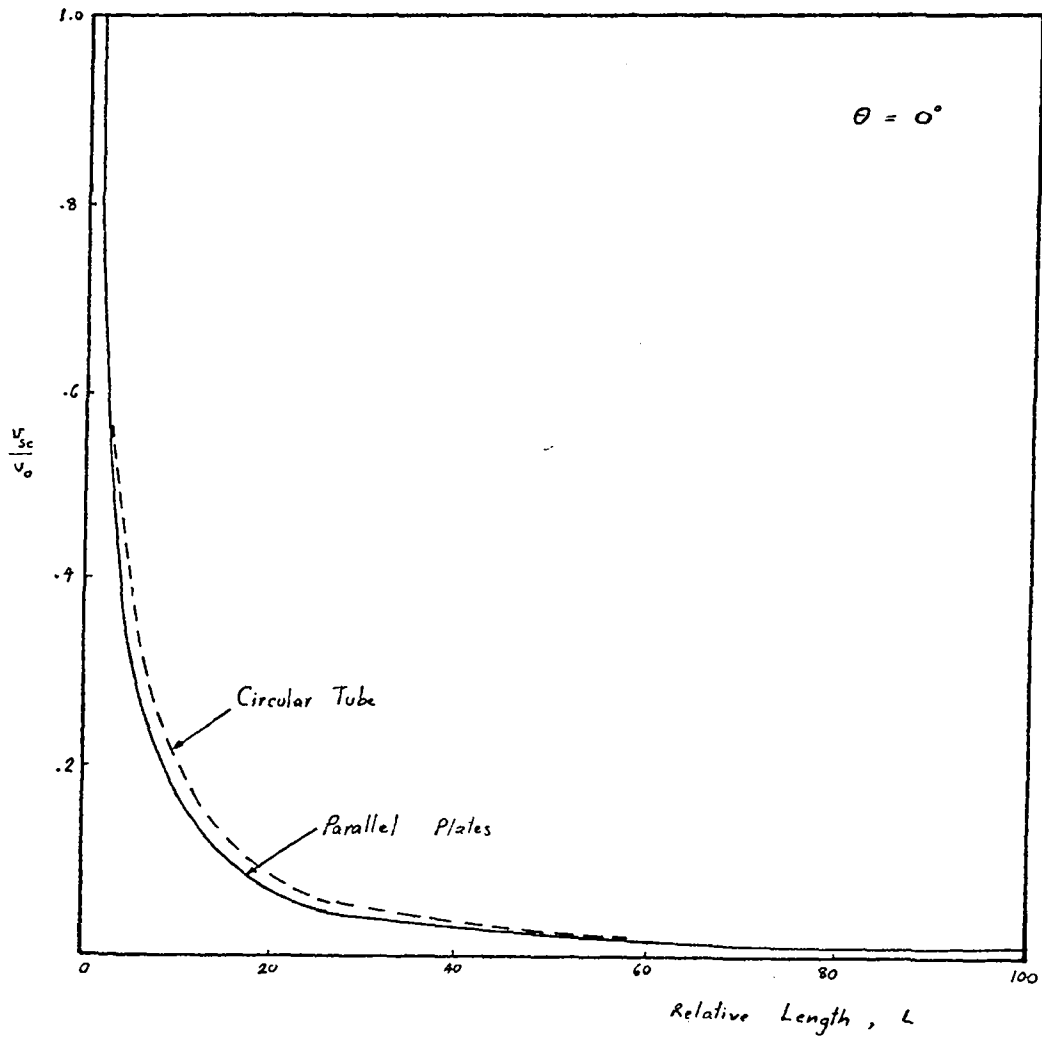

Fig. 2.14 Relative Settler Length vs. Performance ( $\theta = 0^\circ$ )

(After YAO, 1970)

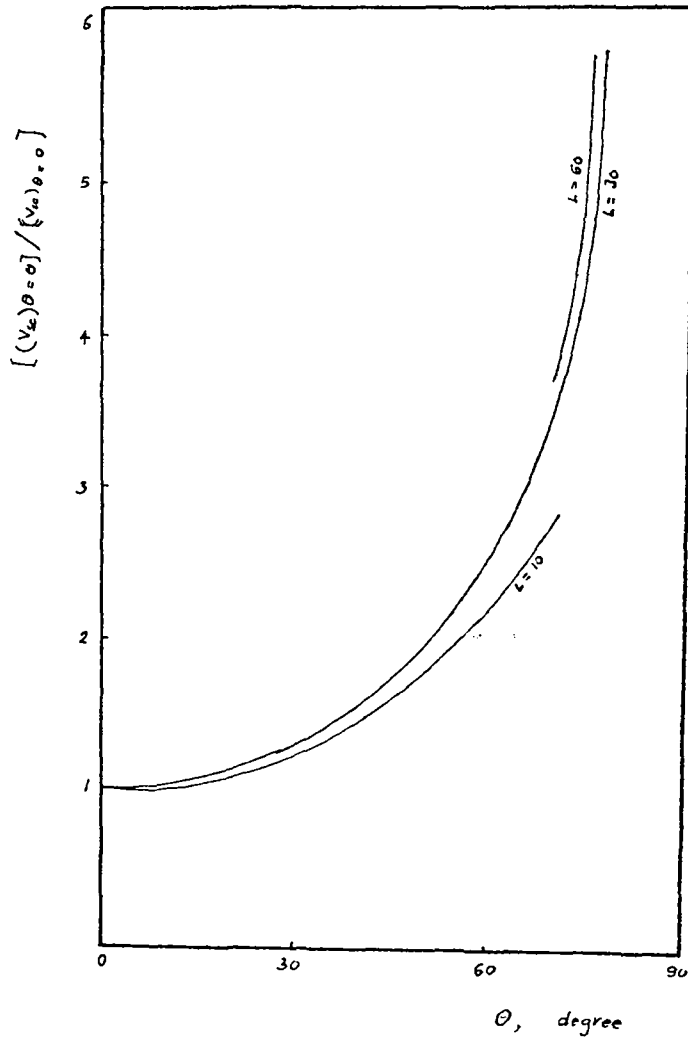

Fig. 2.15 Angle of Inclination vs. Performance

(After YAO, 1970)

### III EXPERIMENTAL INVESTIGATION

#### A. Description of Pilot Plant

The schematic diagram of the unit used in studying the performance of bamboo tube settler is shown in Fig. 3.1. The detail drawings of the settling tank is shown in Fig. 3.2. The system consists of flocculation tank with mechanical mixing, settling tank, coagulant and sulfuric acid tank, rotameters, raw water pump, and chemical feeding pump.

##### (1) Settling Tank

The settling tank used was made of reinforced concrete. The tank was designed with a width of 50 cm and a length of 2.40 m. The tank was partially buried underground. The height of the part above ground level was 1.30 m and that below ground level was about 0.80 m. The bottom of the tank was designed so that the settled particles would flow into sludge hopper from which the sludge was withdrawn via a two-inch pipe. Above the sludge hopper, welded bar covered with wire net was laid on the steel rods projecting from the concrete wall. The bamboo tubes and corrugated asbestos cement were put on this screen. The arrangement of the corrugated asbestos cement was such that the bottom part of the upper plate touched the top part of the lower plate so they formed bundles of tubes as shown in Fig. 3.3. The bamboo tubes were arranged as shown in Fig. 3.4. The inclination angle of the tubes was governed by a sheet of plywood. It could be adjusted to any desired angle within the tank.

The length of the bamboo tubes and the corrugated asbestos cement were varied from three levels, i.e. 120 cm, 90 cm, and 60 cm, so the plywood sheet was cut to the length of 125 cm at start and then when 90 cm tubes and 60 cm tube were used this plywood sheet was cut to 95 cm and 65 cm respectively. Another plywood sheet was set vertically within the tank. This sheet was used for separating the outlet zone from the settling zone and also for supporting the inclined plywood sheet. The sides of these plywood sheets which contacted to the concrete wall were sealed with plasticine so that the water could not leak from the settling zone without passing through the tubes.

##### (2) Flocculation Tank

The flocculation tank was a steel tank. The dimension of the tank was 60 cm in length and width and 100 cm in height. The tank was fitted with steel paddles driver by an electric motor which was set on the tank as shown in Fig. 3.5. The paddle rotated at speed of 40 rpm. From the tank there were two outlet pipes, one for overflow and the another was connected to the settling tank. The pipe connected from flocculation tank outlet was divided into two pipes by using a T-connection. One pipe was connected to the settling tank, the other to the drainage. This was designed so that the flocculation time for each flow rate could be controlled to the same value. The rate of flow was controlled by valves.

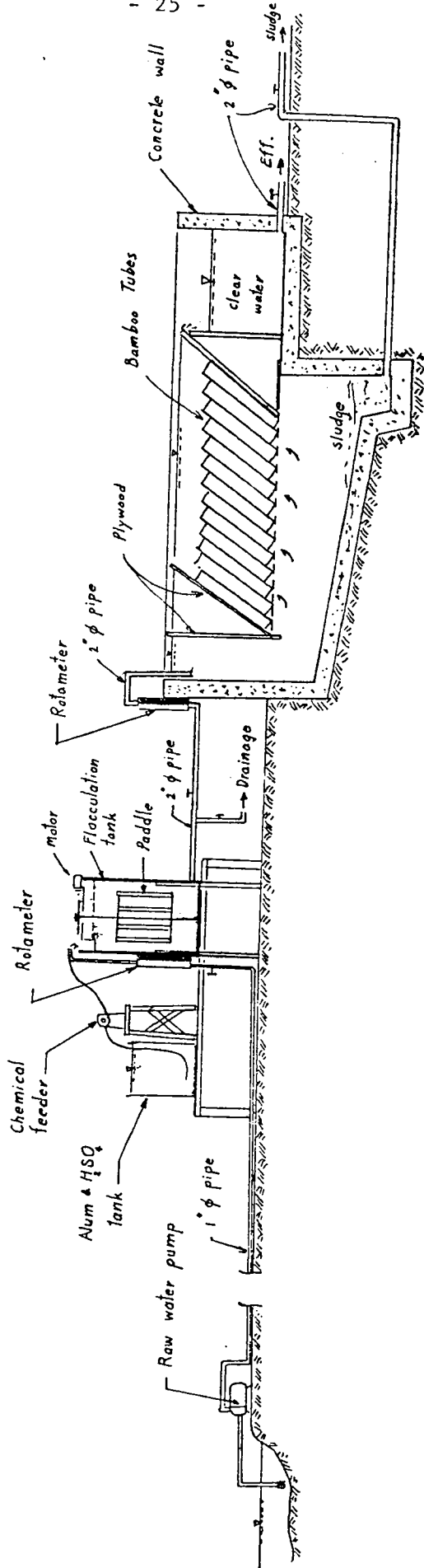

Fig. 3.1 Pilot Plant Layout



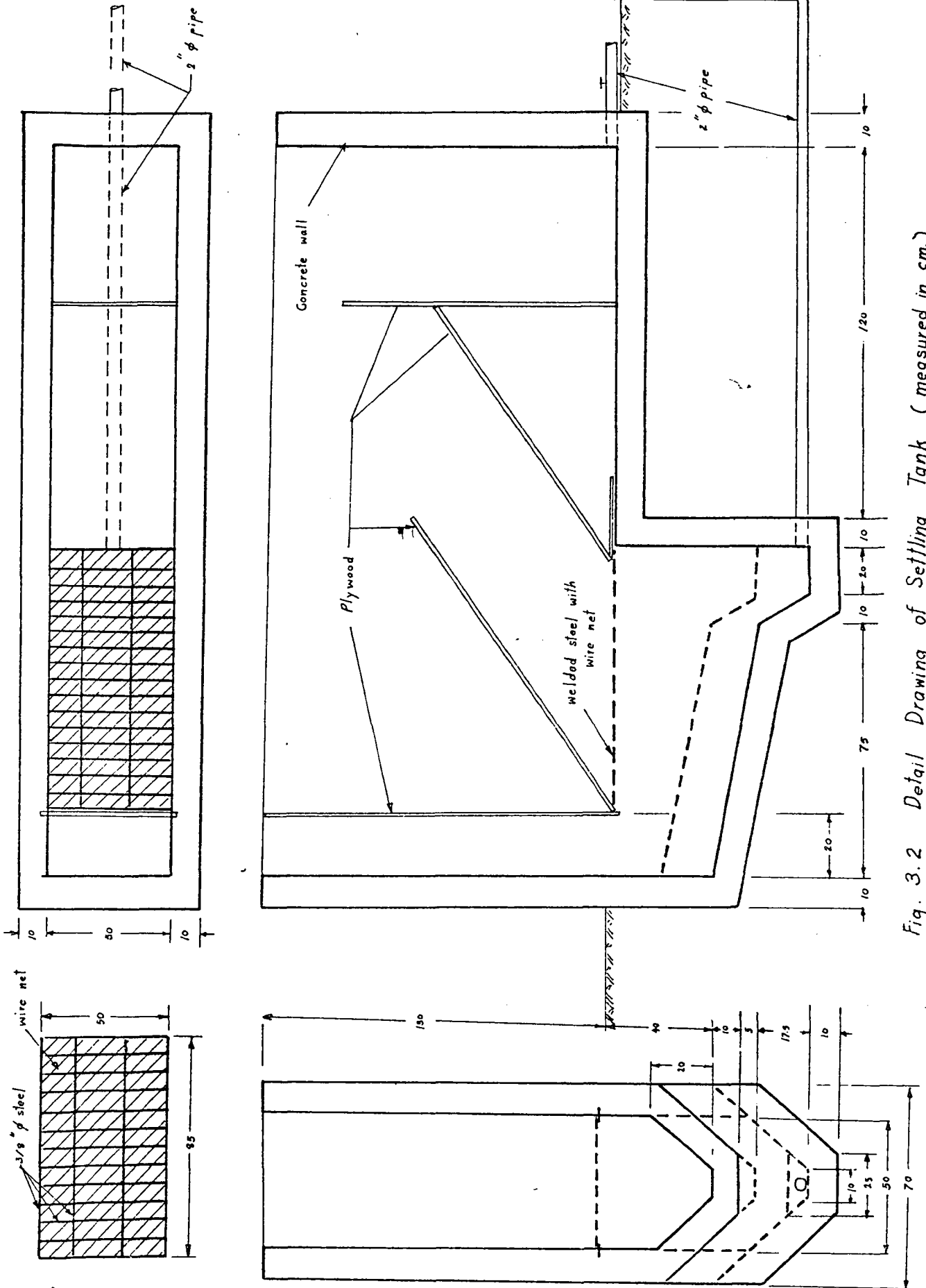
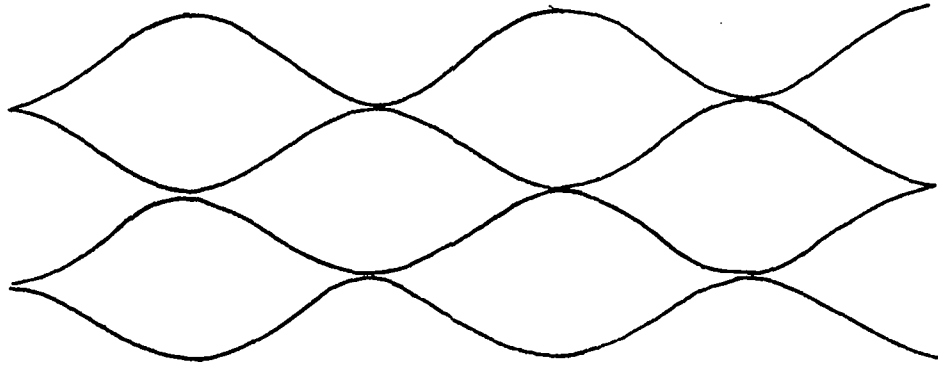
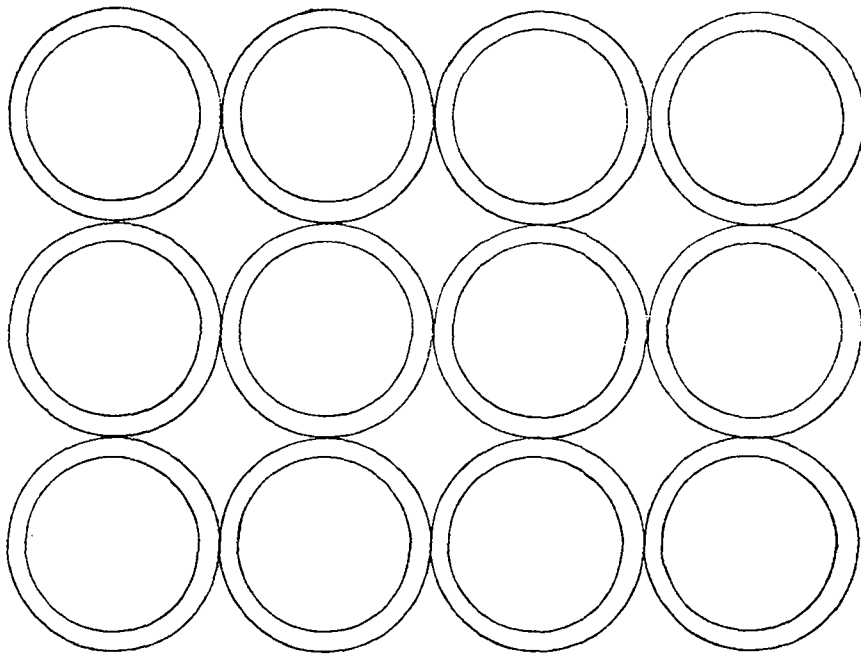

Fig. 3.2 Detail Drawing of Settling Tank (measured in cm.)



*Fig. 3.3 Arrangement of Corrugated Asbestos Cement*



*Fig. 3.4 Arrangement of Bamboo*

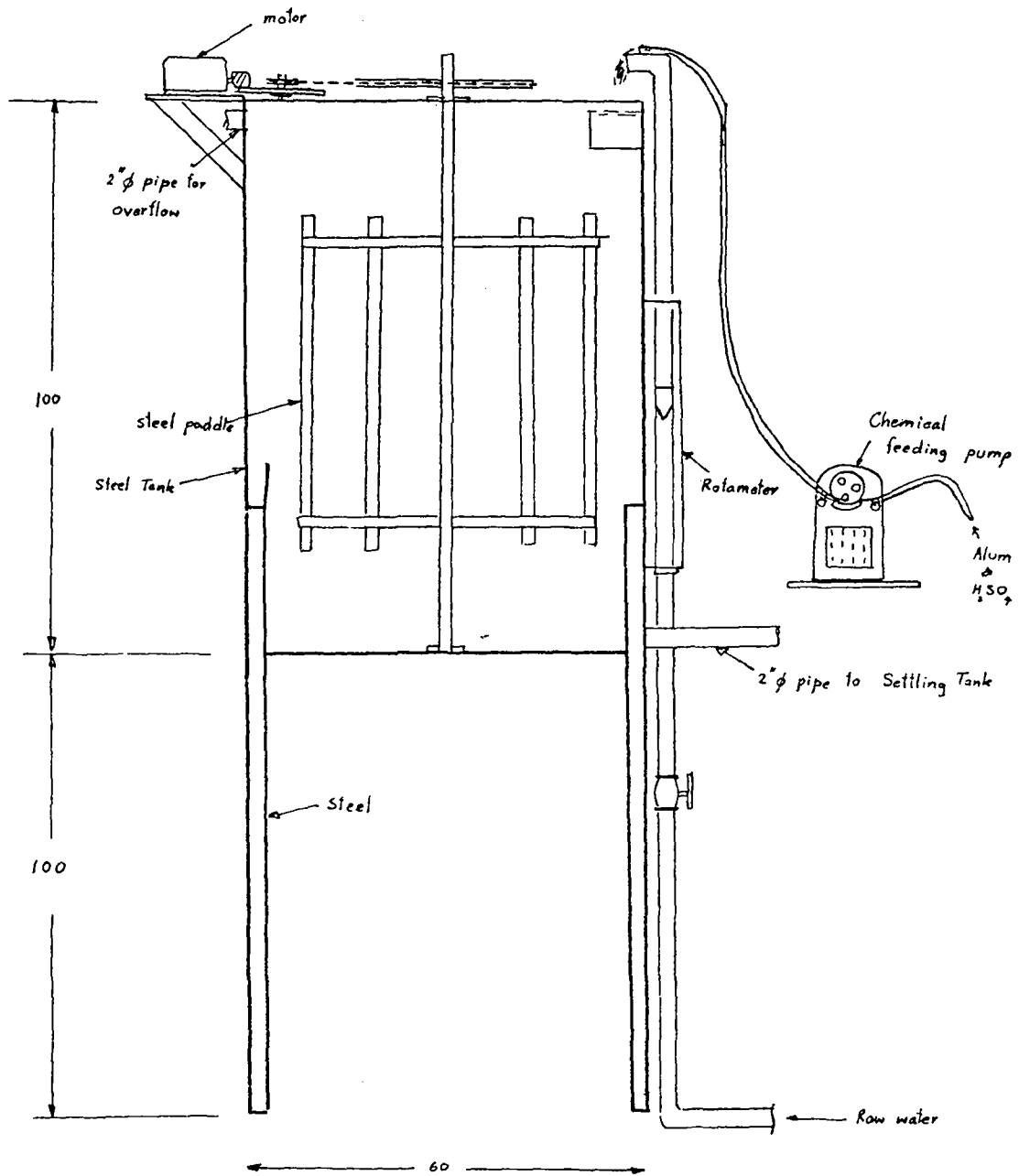

Fig. 3.5 Detail Drawing of Flocculator (measured in cm.)

Rotameters were used to measure the flow rate. Raw wastes was pumped into the tank at the top. Chemical were added to the raw water by using chemical feeding pumps. Hydraulic mixing was used for flash mixing. The details of the flocculation tank is shown in Fig. 3.5.

### (3) Chemical Tank

Alum was used as coagulant and coagulant aid was not used in the test. The pH value of raw water was too high so sulfuric acid was used to adjust the pH to the optimum value for coagulation. Because of the lack of chemical tank and chemical feeding pumps, alum and sulfuric acid were mixed and diluted in the same tank. The speed of the feeding pumps could be adjusted so the concentration of alum and sulfuric acid must be controlled to the calculated values. The tank was 60 cm in length, 60 cm in width, and 100 cm in depth. The tank was made of pvc sheets.

## B. Experimental Design

In this study, bamboo and corrugated asbestos cement were used as tube settlers for automatic draining of accumulated sludge. The independent variables which affected settling performance included.

1. Tube length
2. Tube diameter
3. Inclination angle
4. Flow rate

The corrugated asbestos cement used was about 1.20 cm in amplitude and 7.50 cm in wave length. The thickness was about 0.40 cm. Another parameters such as length, inclination angle and flow rate were varied in the same level as that of the bamboo tubes settler.

The uncontrolled independent variables in this study were raw water characteristics which included turbidity, pH, alkalinity, temperature, and particle size distribution.

The dependent variables which were measured to evaluate the settling performance included turbidity and pH.

In this study the alum dosage was controlled at 120 mg/l and pH was adjusted within the range of 6.2 to 6.4. Operating time for each run was about 6 hrs.

## C. Procedure and Analytical Methods

### (1) Preliminary Tests

Preliminary tests were required to determine the optimum alum dosage and optimum pH. The optimum alum dosage was determined by the

jar-test technique and by running the pilot plant. The optimum alum dosage was first determined, and then by using this optimum value, the optimum pH was determined. Sulfuric acid was used to adjust the pH of raw water. The amount of sulfuric acid required for adjusting the pH to the optimum value was recorded.

(2) Pilot Plant Investigation

The length of bamboos and corrugated asbestos cement was varied at the level of 120 cm, 90 cm, and 60 cm. The diameter of the bamboos was varied at the level of 4.0 cm, 6.5 cm and 8.5 cm. The inclination angle was at 70, 60, and 50 degrees. The rate of flow was controlled at the values of 4.0, 8.0, and 12.0 m<sup>3</sup>/hr-m<sup>2</sup> of tube end area. The alum dosage and pH were kept constant at the optimum values obtained from the preliminary test. Turbidity and pH were measured every hour to evaluate the settling performance. The rate of flow was checked every hour. The temperature was measured occasionally. The operating time for each run was 6 hours.

#### IV PRESENTATION AND DISCUSSION OF RESULTS

The results obtained from the jar test technique and from the pilot plant operation in finding the optimum alum dosage and optimum pH value are shown in Tables A1 - A3 and Fig. 4.1, 4.2 and 4.3. The results from the tube settling performance under various conditions are shown in Table B1 in appendix B and Fig. 4.1 - 4.18. The raw water turbidity, effluent turbidity, and 50 the turbidity removal efficiency shown are the average values in the period of 6 hours for each run.

##### A. Raw Water Characteristics

AIT klong (canal) water was used as raw water. The turbidity varied from 100 JTU to 140 JTU. It was low at the beginning of the test (about 100 JTU). The pH value varied from 8.0 to 8.6 and the temperature varied from 24°C to 30°C.

##### B. Optimum Alum Dosage and Optimum pH

The jar test technique was done to find the optimum alum dosage and pH value, and then the procedure was repeated by using the pilot plant. In jar test procedure the paddle speed was adjusted to 100 rpm for rapid mixing and 40 rpm for slow mixing: The flocculation time was only 10 min. so that it would be similar to the condition in the pilot plant. The alum dosage were varied from 60 mg/l to 160 mg/l, no polyelectrolyte was added. The pH was first adjusted to 6.5. The results obtained indicated that the turbidity removal efficiency increased as the alum dosage was increased, as shown in Fig. 4.1. The increase in turbidity removal efficiency was small at alum dosage more than 120 mg/l. By maintaining the alum dosage at 120 mg/l and varying the pH from 6.0 to 7.2, it was found that the removal efficiency was high at low pH. In order to obtain low pH much more sulfuric acid was needed. For economic standpoint the pH was controlled within the range of 6.2 to 6.4.

In evaluating the optimum alum dosage by using the pilot plant, the plant was run at the flow rate of 4.0 m<sup>3</sup>/hr-m<sup>2</sup> of tank surface area with 4.0 cm diameter and 120 cm bamboo tubes. The inclination angle was at 70 degree and pH was controlled at 6.2. These conditions were expected to give the best result. The speed of the paddle in the flocculator was constant at about 40 rpm. The flocculation time was controlled at about 10 minutes by adjusting valves. The alum dosage was varied from 100 to 180 mg/l. The results were plotted as shown in Fig. 4.3. These results showed that the more alum dosage would give the higher removal efficiency. However the removal efficiency was not much different and so for economic standpoint the dosage of 120 mg/l would be used through out the experiment.

##### C. Tube Settler Performance

The results obtained from the performance of inclined tube settlers

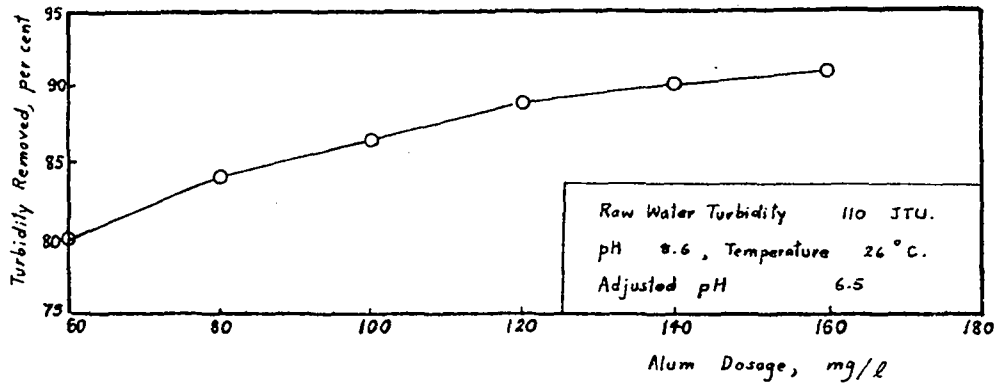

Fig. 4.1 Determination of Optimum Alum Dosage by Jar-Test Technique

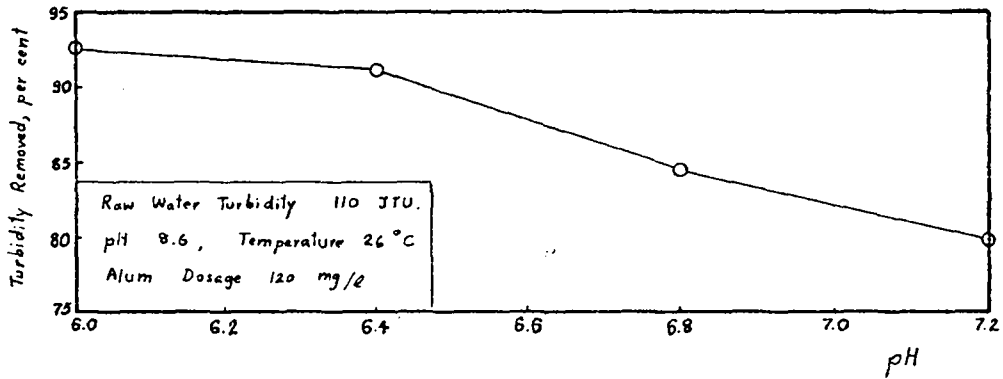

Fig. 4.2 Determination of Optimum pH by Jar-Test Technique

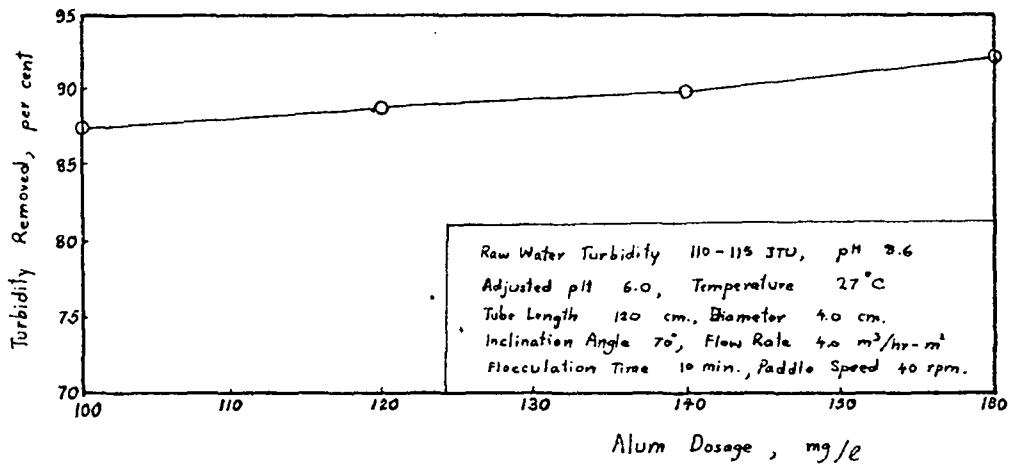
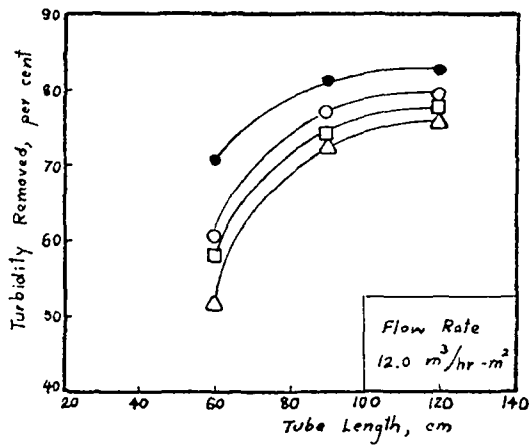
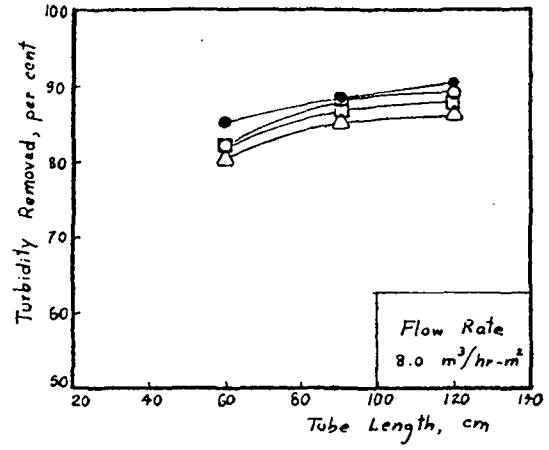
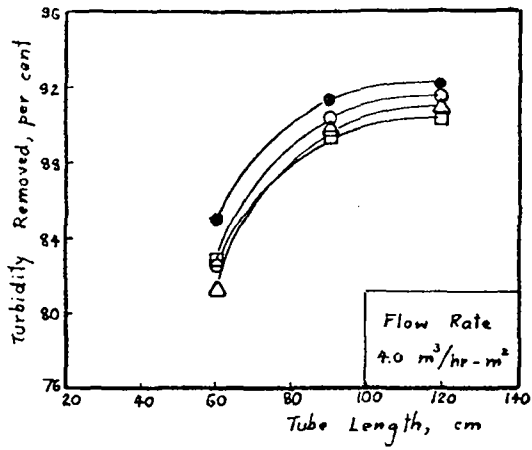

Fig. 4.3 Determination of Optimum Alum Dosage by Pilot Plant



Legend

- 4.0 cm. Diameter Tube
- 6.5 cm. Diameter Tube
- △— 8.5 cm. Diameter Tube
- Corrugated Asbestos Cement

Conditions of Test

Raw Water Turbidity 100-140 JTU.  
 pH 8.0-8.6 ; Adjusted pH 6.2-6.4  
 Alum Dosage 120 mg/l  
 Flocculation Time 10 min.  
 Inclination Angle 70 degrees

Fig. 4.4 Effect of Tube Length on Settling Performance



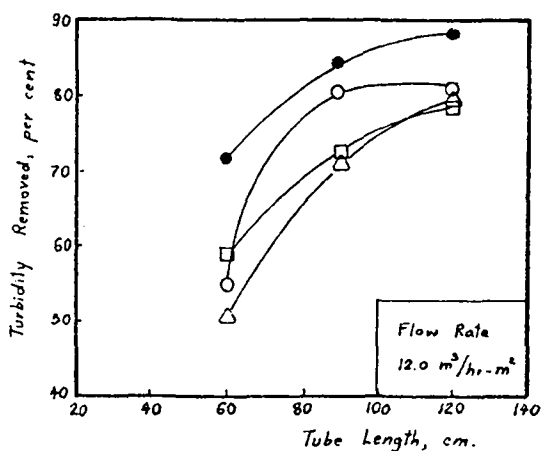
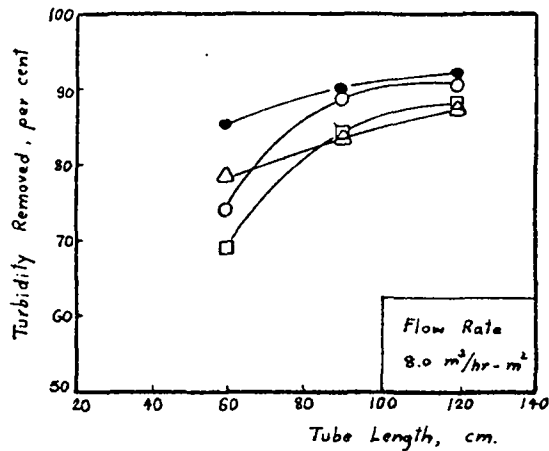
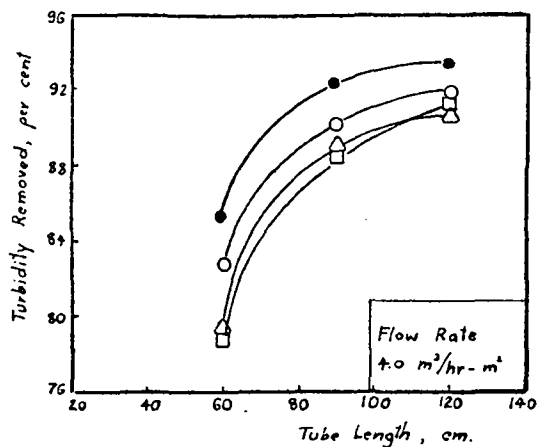

Legend.

- 4.0 cm. Diameter Tube
- 6.5 cm. Diameter Tube
- △— 8.5 cm. Diameter Tube
- Corrugated Asbestos Cement

Conditions of Test

Raw Water Turbidity 100-140 STU.,  
 pH 8.0 - 8.6, Adjusted pH 6.2 - 6.4,  
 Alum Dosage 120 mg/l.,  
 Flocculation Time 10 min.  
 Inclination Angle 60 degrees

Fig. 4.5 Effect of Tube Length on Settling Performance

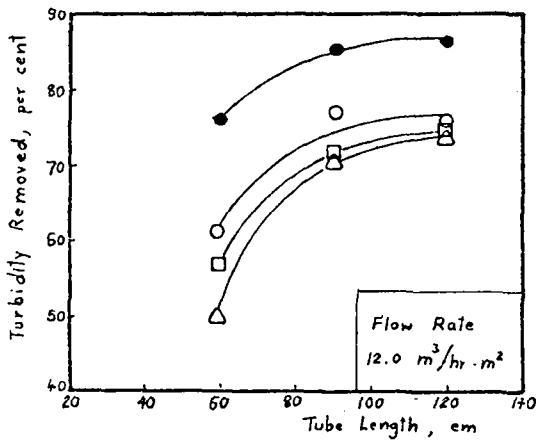
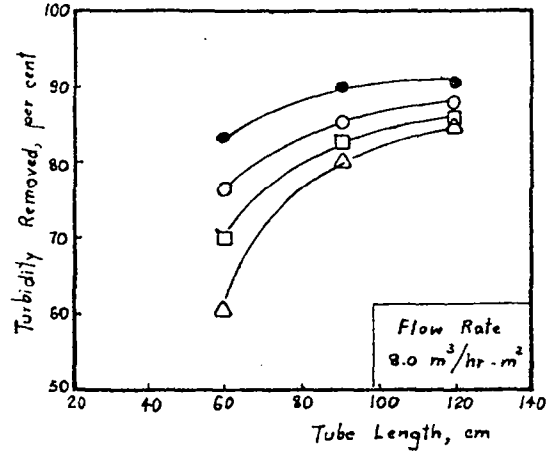
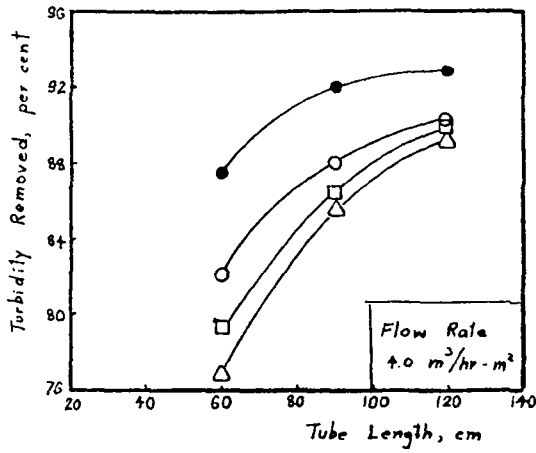

Legend

- 4.0 cm. Diameter Tube
- 6.5 cm Diameter Tube
- △— 8.5 cm Diameter Tube
- Corrugated Asbestos Cement

Conditions of Test

Raw Water Turbidity 100 - 140 JTU.  
 pH 8.0 - 8.6 , Adjusted pH 6.2 - 6.4  
 Alum Dosage 120 mg/l.  
 Flocculation Time 10 min.  
 Inclination Angle 50 degrees

Fig. 4.6 Effect of Tube Length on Settling Performance

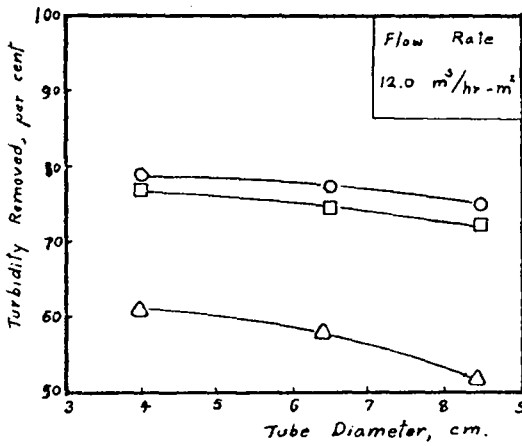
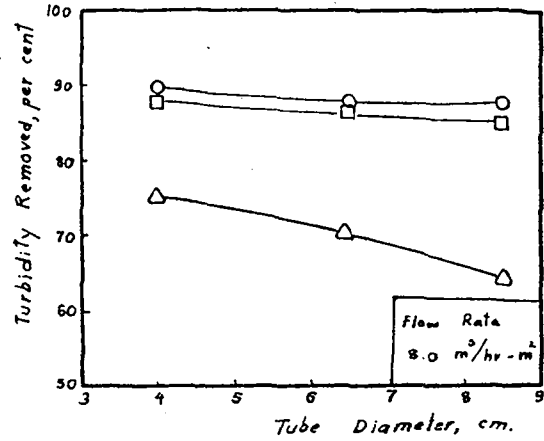
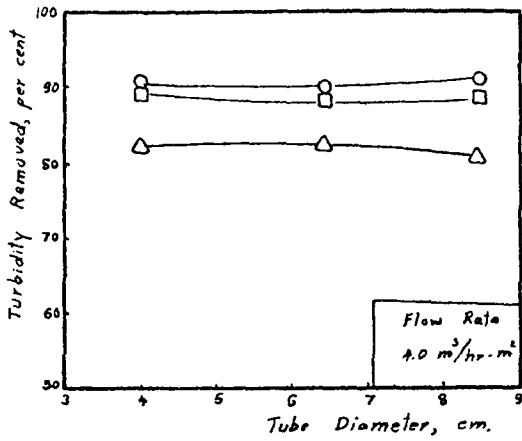

Legend

- 120 cm. Tube
- 90 cm Tube
- △ 60 cm Tube

Conditions of Test

Raw Water Turbidity 100 - 140 JTU.  
 pH 8.0 - 8.6 ; Adjusted pH 6.2 - 6.4 ;  
 Alum Dosage 120 mg/l ;  
 Flocculation Time 10 min.  
 Inclination Angle 70 degrees

Fig. 4.7 Effect of Tube Diameter on Settling Performance

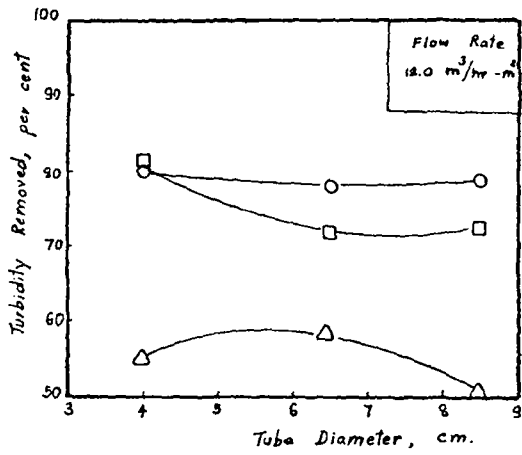
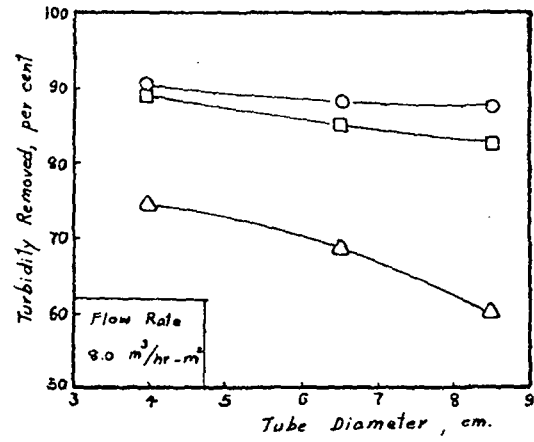
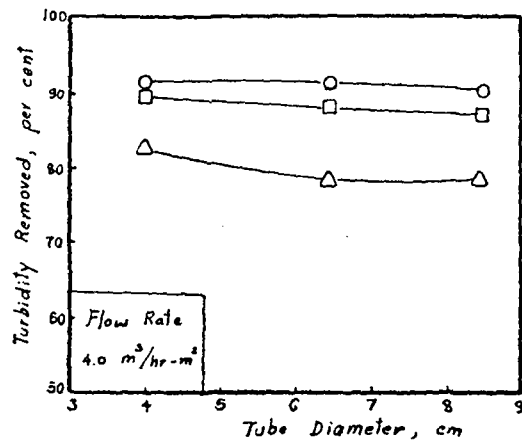

Legend

- 120 cm. Tube
- 90 cm Tube
- △— 60 cm. Tube

Conditions of Test

Raw Water Turbidity 100-140 JTU.  
 pH 8.0-8.6 ; Adjusted pH 6.2-6.4 ;  
 Alum Dosage 120 mg/l ;  
 Flocculation Time 10 min.  
 Inclination Angle 60 degrees

Fig. 4.8 Effect of Tube Diameter on Settling Performance

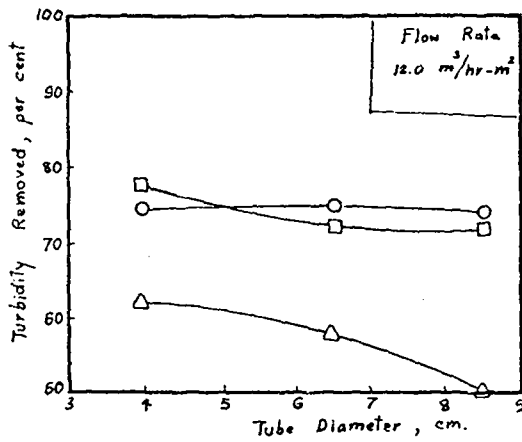
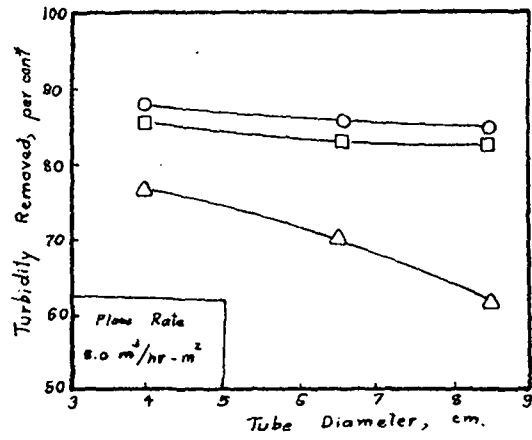
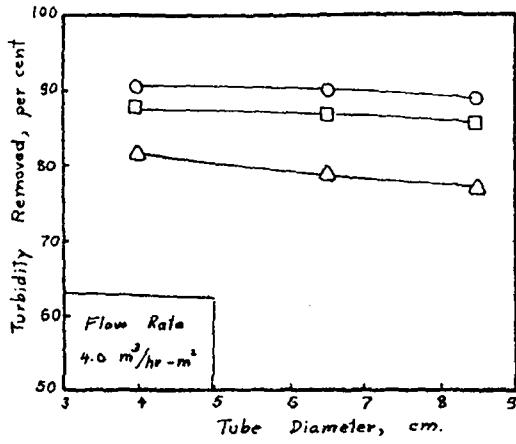

Legend

- 120 cm Tube
- 90 cm. Tube
- △ 60 cm. Tube

Conditions of Test

Raw Water Turbidity 100-140 JTU.  
 pH 8.0 - 8.6 ; Adjusted pH 6.2 - 6.4 ;  
 Alum Dosage 120 mg/l.  
 Flocculation Time 10 min.  
 Inclination Angle 50 degrees

Fig. 4.9 Effect of Tube Diameter on Settling Performance

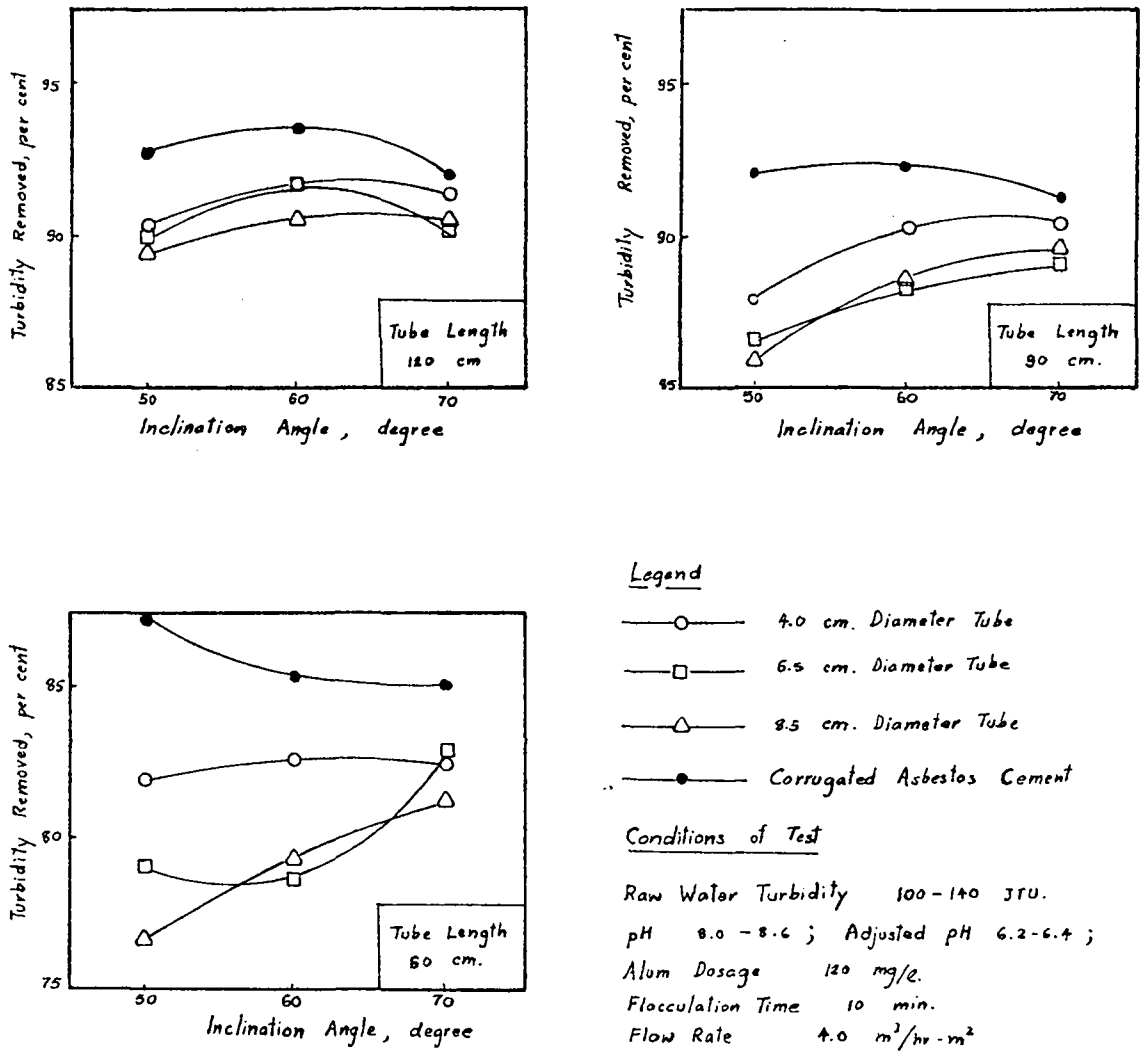
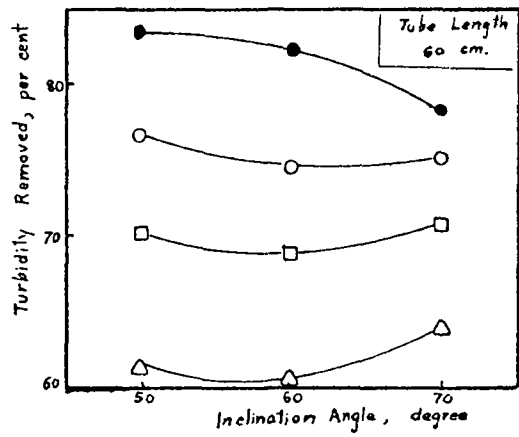
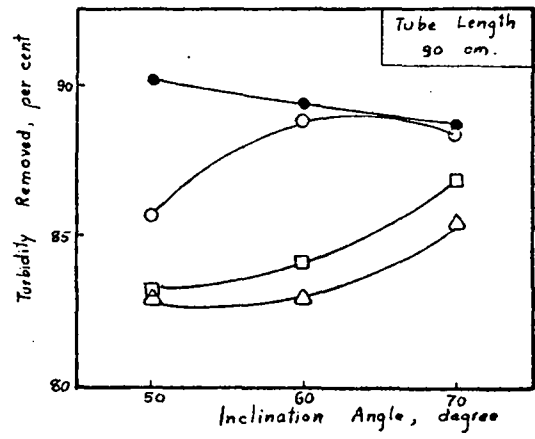
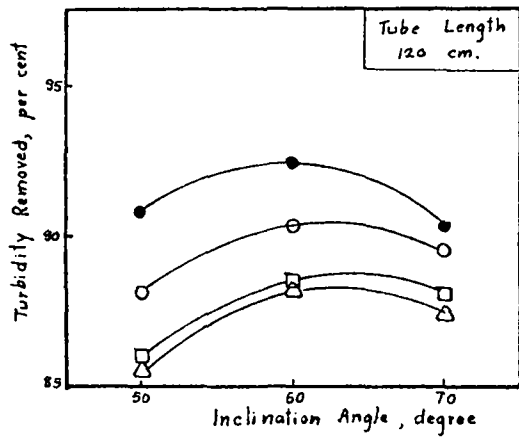

Fig. 4.10 Effect of Inclination Angle on Settling Performance



Legend

- 4.0 cm. Diameter Tube
- 5.5 cm. Diameter Tube
- △— 8.5 cm. Diameter Tube
- Corrugated Asbestos Cement

Conditions of Test

Raw Water Turbidity 100 - 140 JTU.  
 pH 8.0 - 8.6 ; Adjusted pH 6.2 - 6.4  
 Alum Dosage 120 mg/l.  
 Flocculation Time 10 min.  
 Flow Rate 2.0 m<sup>3</sup>/hr-m<sup>2</sup>

Fig. 4.11 Effect of Inclination Angle on Settling Performance

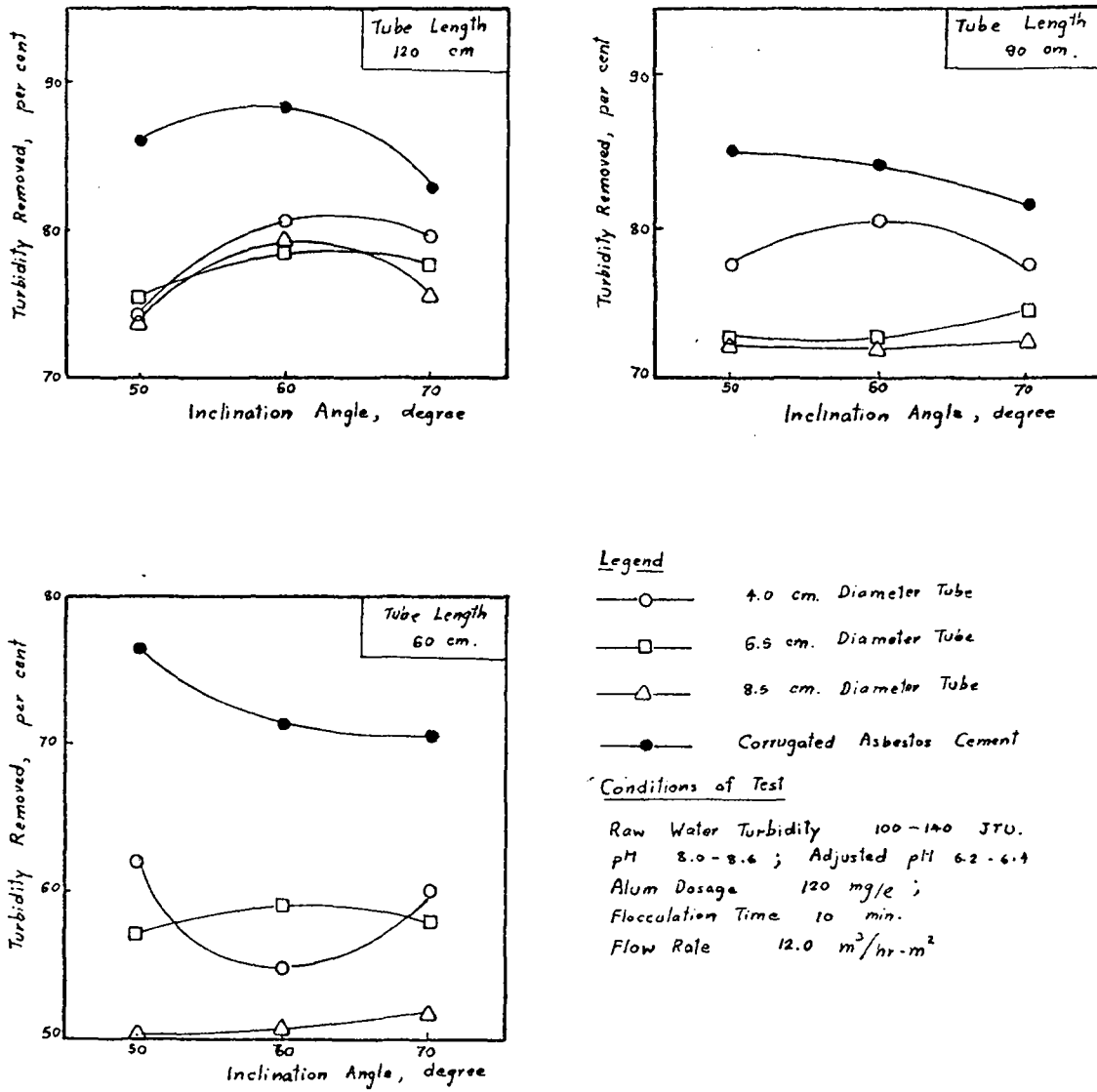
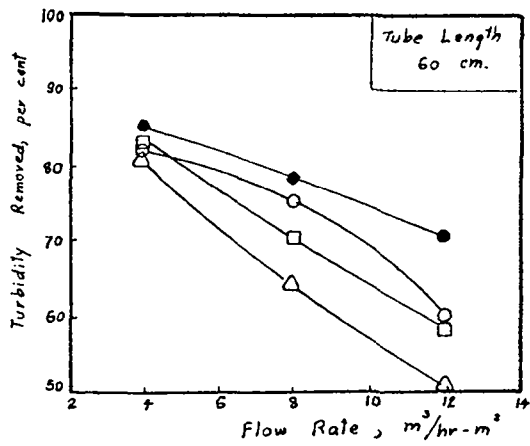
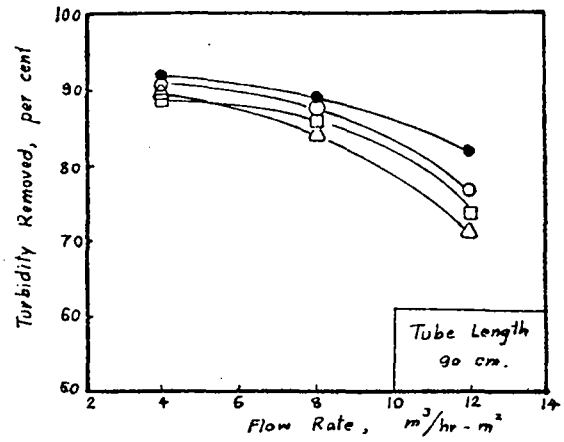
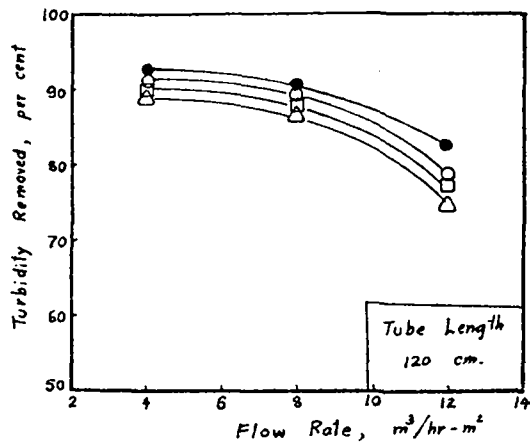

Fig. 4.12 Effect of Inclination Angle on Settling Performance





Legend

- 4.0 cm. Diameter Tube
- 6.5 cm. Diameter Tube
- △— 8.5 cm. Diameter Tube
- Corrugated Asbestos Cement

Conditions of Test

Raw Water Turbidity 100 - 140 JTU  
 pH 8.0 - 8.6 ; Adjusted pH 6.2 - 6.4 ;  
 Alum Dosage 120 mg/l ;  
 Flocculation Time 10 min.  
 Inclination Angle 70 degrees

Fig. 4.13 Effect of Flow Rate on Settling Performance

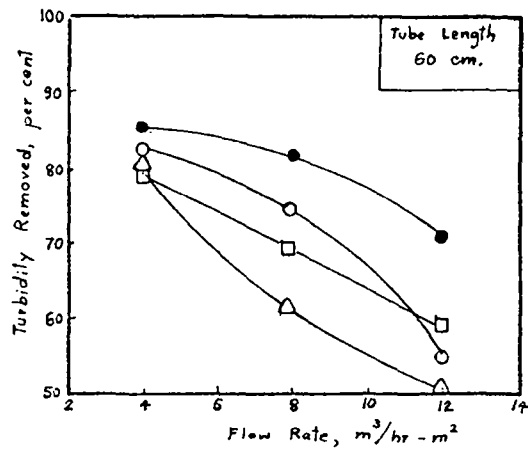
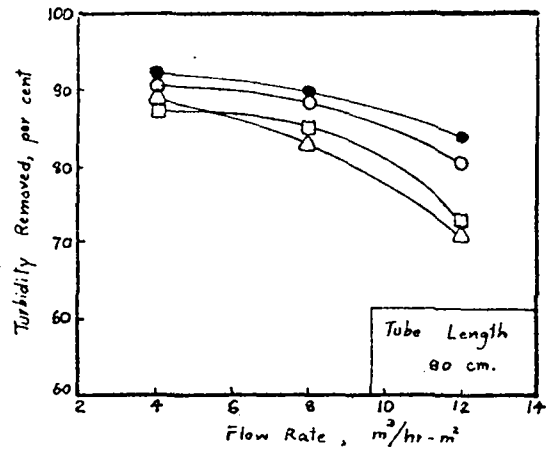
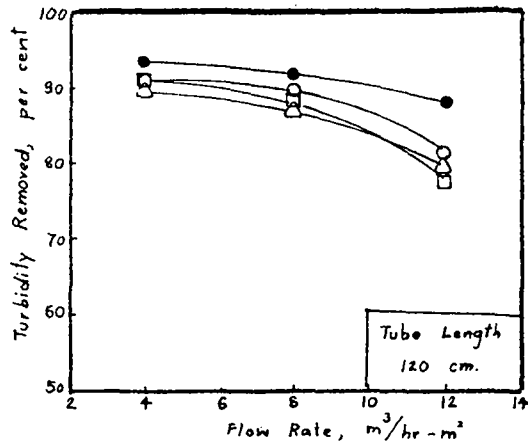

Legend.

- 4.0 cm. Diameter Tube
- 6.5 cm. Diameter Tube
- △ 8.5 cm. Diameter Tube
- Corrugated Asbestos Cement

Conditions of Test

Raw Water Turbidity 100-140 JTU.  
 pH 8.0 - 8.6 ; Adjusted pH 6.2-6.4 ;  
 Alum Dosage 120 mg/l.  
 Flocculation Time 10 min.  
 Inclination Angle 60 degrees

Fig. 4.14 Effect of Flow Rate on Settling Performance

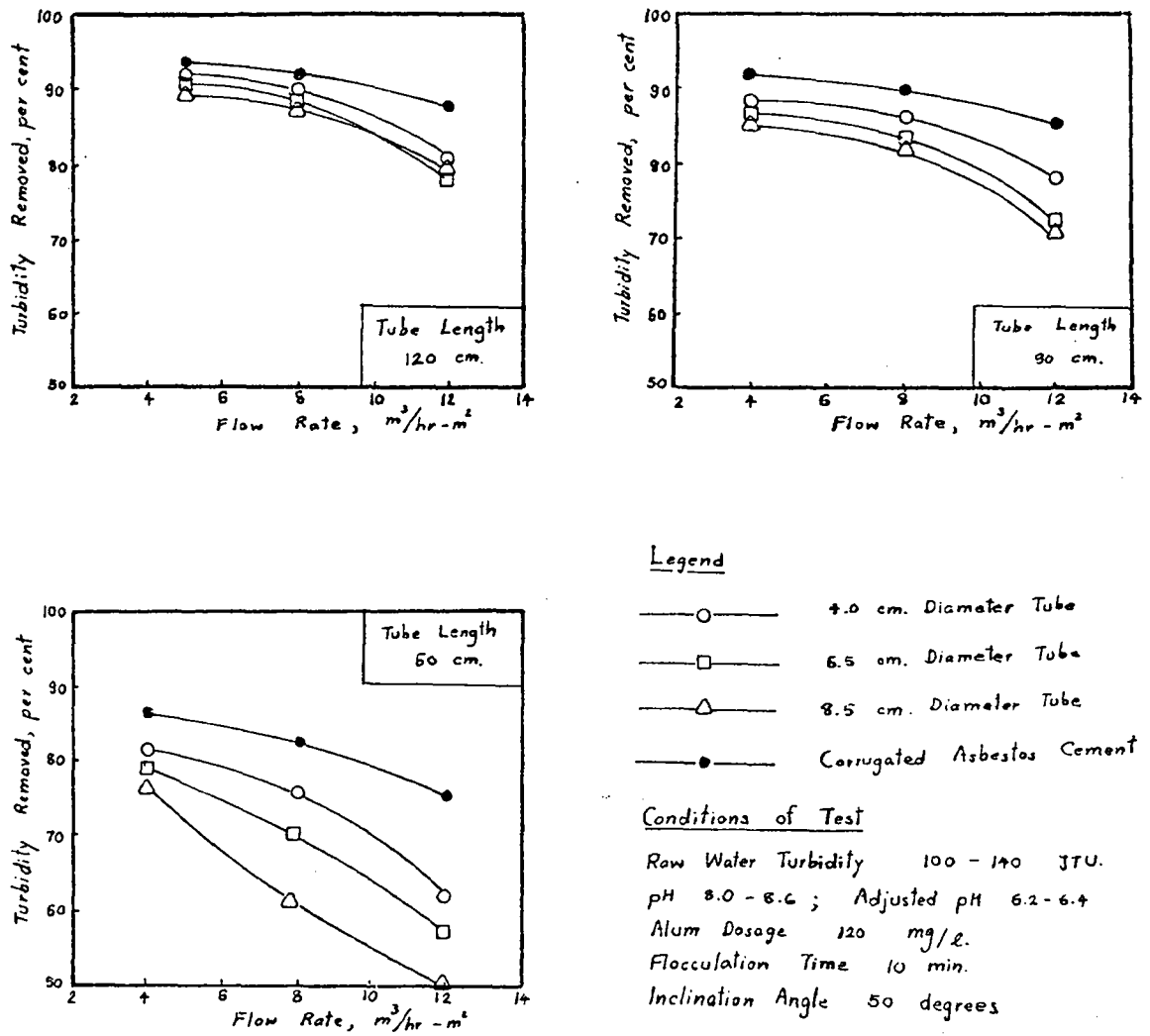
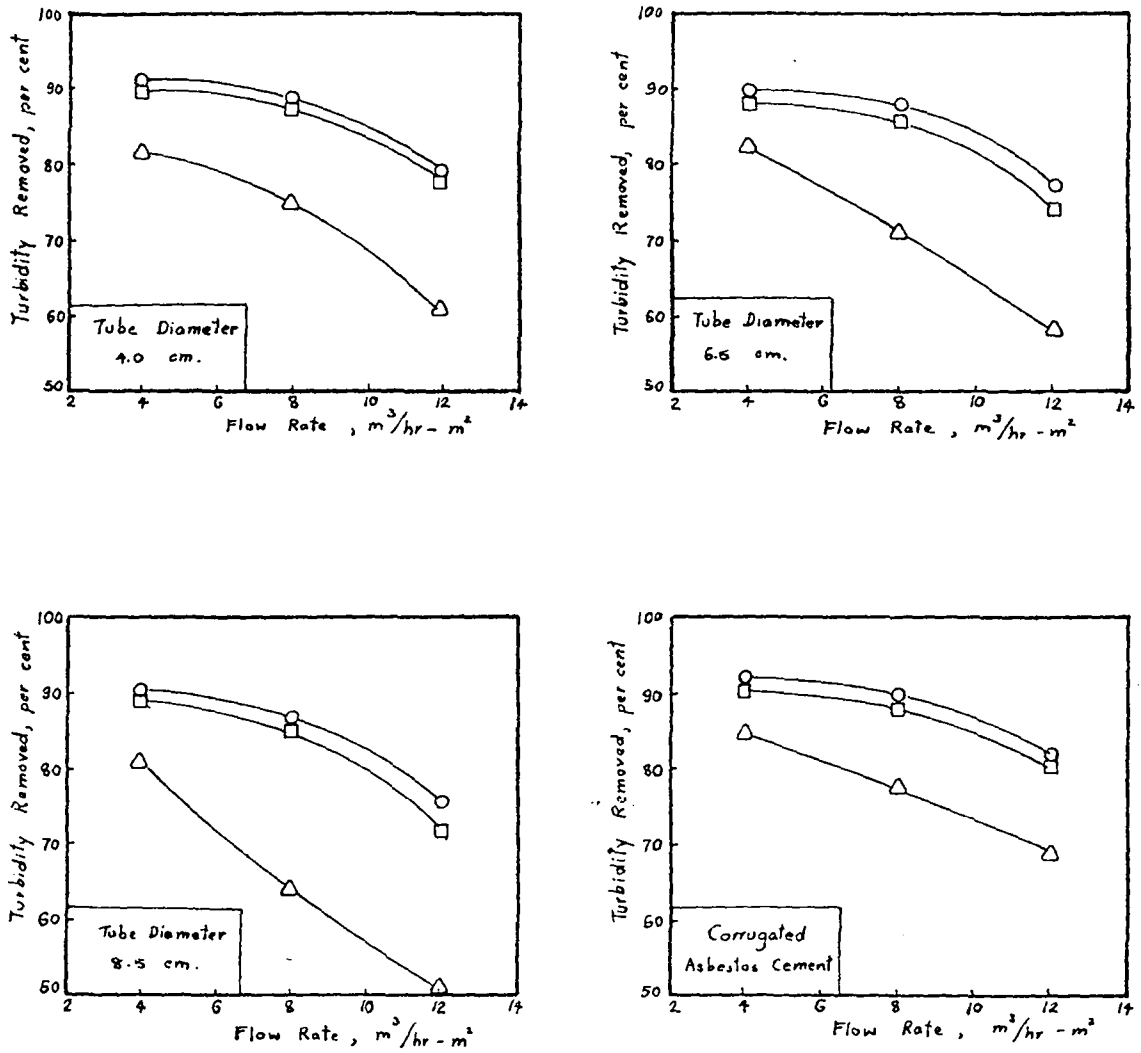

Fig. 4.15 Effect of Flow Rate on Settling Performance



Legend  
 ○ — 120 cm. Tube  
 □ — 90 cm. Tube  
 △ — 60 cm. Tube

Conditions of Test  
 Raw Water Turbidity 100-140 JTU  
 pH 5.0-5.6; Adjusted pH 6.2-6.4;  
 Alum Dosage 120 mg/l;  
 Flocculation Time 10 min.  
 Inclination Angle 70 degrees

Fig. 4.16 Effect of Flow Rate on Settling Performance

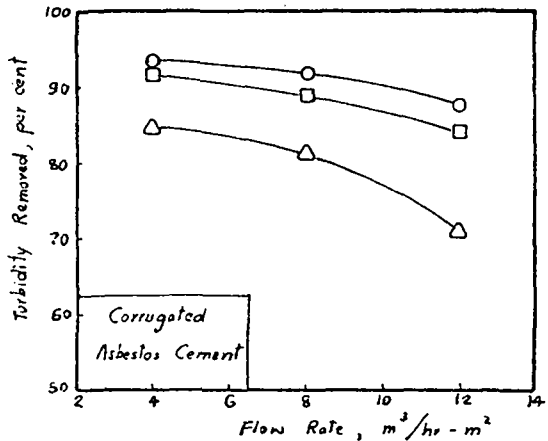
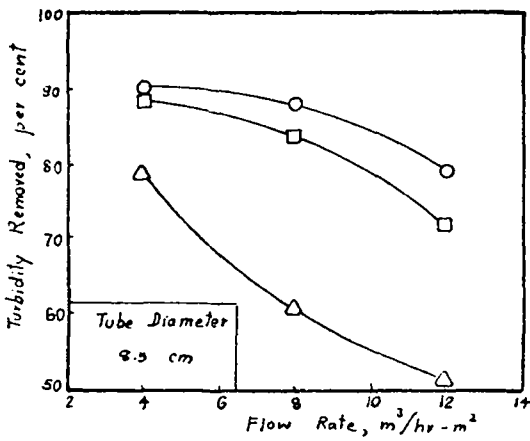
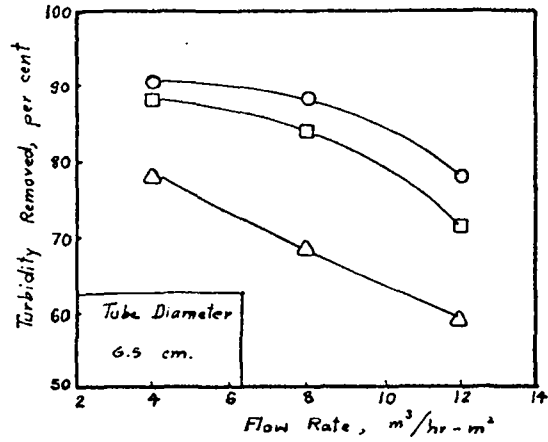
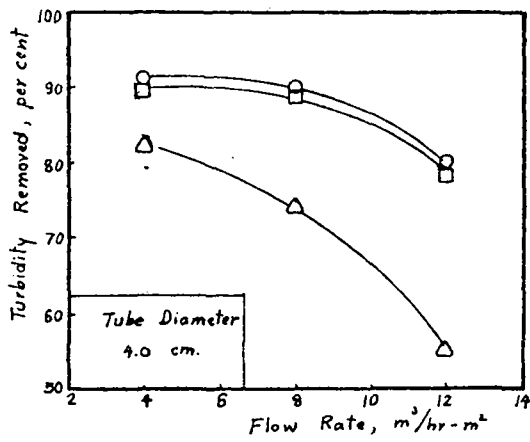

Legend

- 120 cm. Tube
- 90 cm. Tube
- △— 60 cm. Tube

Conditions of Test

Raw Water Turbidity 100 - 140 JTU.  
 pH 8.0 - 8.6 ; Adjusted pH 6.2 - 6.4  
 Alum Dosage 120 mg/l.  
 Flocculation Time 10 min.  
 Inclination Angle 60 degrees

Fig. 4.17 Effect of Flow Rate on Settling Performance

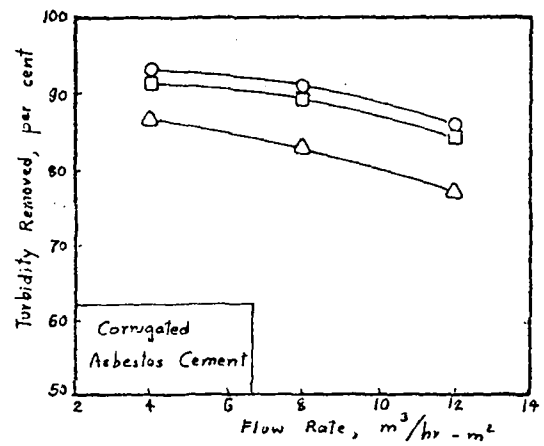
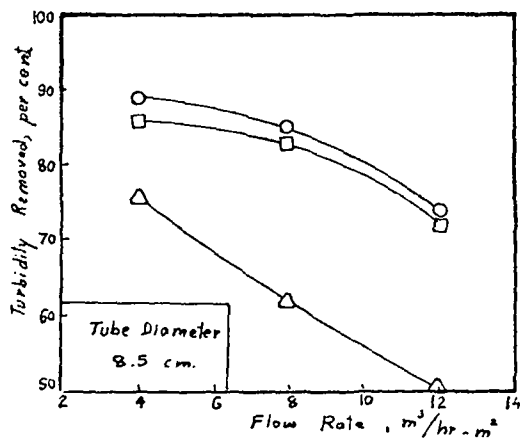
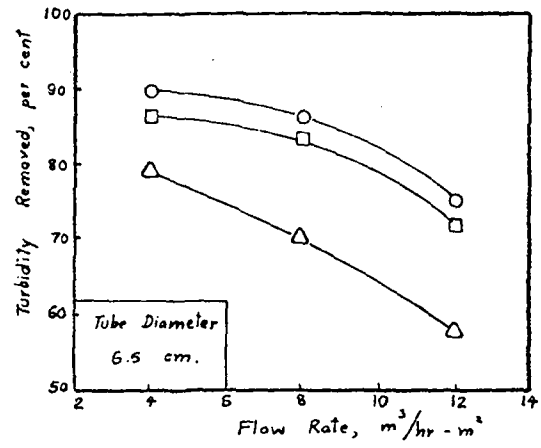
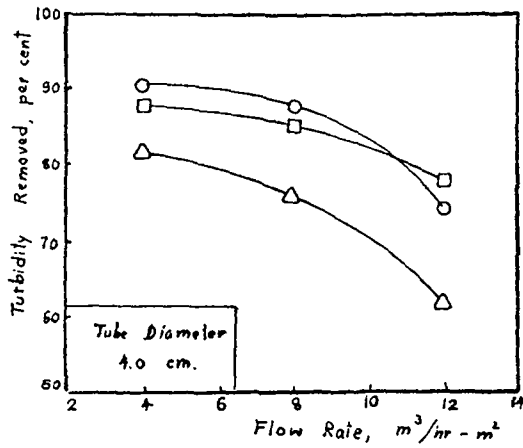

Legend

- 120 cm Tube
- 90 cm Tube
- △ 60 cm Tube

Conditions of Test

Raw Water Turbidity 100 - 140 JTU.  
 pH 8.0 - 8.6 ; Adjusted pH 6.2 - 6.4  
 Alum Dosage 120 mg/l.  
 Flocculation Time 10 min.  
 Inclination Angle 50 degrees

Fig. 4-18 Effect of Flow Rate on Settling Performance

under various conditions are summarized in Table B-1 in Appendix B. The alum dosage used in the tests was 120 mg/l and pH was adjusted within the range of 6.2 to 6.4. Effect of each parameter, i.e. tube length, diameter, inclination angle, and flow rate, on the removal efficiency are shown by Figs. 4.4 - 4.18.

(1) Effect of Tube Length on Removal Efficiency

From Figs. 4.4, 4.5, and 4.6, it can be seen that the efficiency of turbidity removal decreases as the length of the tube decreases. The rate of decrease in efficiency also depends on the tube diameter, inclination angle, and rate of flow. For the smaller tube the decrease in efficiency with decrease in tube length is less significant than the larger tube. The decrease in efficiency when the length was reduced from 120 cm to 90 cm is much less than the values obtained when the length was reduced from 90 cm to 60 cm, especially when the flow rate is high. From the results obtained in this experiment the inclination angle seems to have less effect upon the change in removal efficiency due to change in tube length.

From corrugated asbestos cement tube settler, the change in removal efficiency with change in length is less than the bamboo tube settlers as will be discussed later. For all length the turbidity removal efficiency is higher than bamboo tube settler.

By comparing the results obtained from this experiment to that obtained from CULP, HANSEN and RICHARDSON (1968) it can be seen that the change in removal efficiency due to change in tube length for these two experiments is a little different. From this experiment the change in removal efficiency for 4.0 cm-diameter tube and run at the flow rate of  $4.0 \text{ m}^3/\text{hr-m}^2$  was about 8-9 per cent when the length changed from 120 to 60 cm. From CULP, HANSEN, and RICHARDSON (1968), the change in removal efficiency for 5.0 cm-diameter tube and run at the flow rate of  $5.0 \text{ m}^3/\text{hr-m}^2$  was about 4 per cent. For larger tube the change in removal efficiency due to change in tube length was nearly the same as that at smaller tube in this experiment, but from CULP, HANSEN, RICHARDSON (1968) the removal efficiency for 10 cm-diameter tube and run at the flow rate of  $5.0 \text{ m}^3/\text{hr-m}^2$  changed about 9 per cent (from 92 per cent for 120 cm-length tube to 83 per cent for 60 cm length tube). For corrugated asbestos cement tube settler operated at  $4.0 \text{ m}^3/\text{hr-m}^2$  the change in removal efficiency was about 8 per cent when the length was changed from 120 cm to 60 cm. This means that in this experiment the effect of tube diameter is less than CULP, HANSEN, and RICHARDSON's experiment as will be discussed later.

(2) Effect of Tube Diameter on Removal Efficiency

From Figs. 4.7, 4.8 and 4.9 it can be seen that the removal efficiency decreases as the tube diameter increases. However the percentage of decrease in removal efficiency is small especially for long tubes. At the flow rate of  $4.0 \text{ m}^3/\text{hr}$  per sq. m. of tank surface area and at 60 degree-inclination angle the change in removal efficiency for the tubes with 120 cm in length was about 1.0 per cent when the diameter changed from

4.0 cm to 8.5 cm. For 60 cm-tubes with the same flow rate and inclination angle the change in removal efficiency was about 4.0 per cent when the diameter was changed from 4.0 to 8.5 cm. For higher flow rates the change in removal efficiency due to change in tube diameter is much more significant.

The effect of tube diameter in this experiment is less important than that obtained from CULP, HANSEN and RICHARDSON (1968). The reason is that in CULP, HANSEN, and RICHARDSON's experiment the results of removal efficiency were obtained from the study of settling performance in individual tube, and so, the settling zone was only in the inside of the tube, while in this experiment the study was performed with a pilot plant in which the bamboo was arranged in bundles. The area of flow and so the settling zone was not only in the inside of the tube but also the space around the tubes. Because bamboo was not so straight and there were nodes the space around the bamboo tubes were not closed space. This made the flow through the space around the tubes not uniform flow, i.e. the water and also the settled particles could leak through the clearance between tubes, and so the removal efficiency within this space was low. For small tubes the number of tubes required per unit area of tank are more than the larger tubes, and also the space around the tubes. So the increase in removal efficiency due to decrease in tube diameter was compensated with the decrease in removal efficiency due to more amount of flow outside the tubes. Thus the change in tube diameter did not very much affect the removal efficiency.

From Table B-1 it can be seen that the results obtained from corrugated asbestos cement tube settler are better than that obtained from the bamboo tube settlers. This is because the corrugated asbestos cement was arranged so that the each space formed between the corrugated sheet could be used as tube settlers. There was no clearance between tubes which allowed the water and particles to leak in the direction of settling. The other reason is that the cross-sectional area of tubes formed by corrugated sheets were smaller than the bamboo tube end area. The smoothness of the tubes is also imported. For bamboo tubes it is difficult to smooth the inside of the tubes and so the transportation of sludge deposit is less than the corrugated asbestos cement tubes settlers.

### (3) Effect of Inclination Angle on Removal Efficiency

The removal efficiency of different inclination angles are plotted as shown in Figs. 4.10, 4.11 and 4.12. It can be seen that the inclination angle has less effect on the removal efficiency. The percent removal is not a function of inclination angle. However for the tube with the length of 120 cm and diameter between 6.5 cm and 8.0 cm, which seemed to be the most suitable size, the removal efficiency was maximum at about 60 degree-inclination angle. For small inclination angle the settled deposits could not be removed automatically by its own weight, and so the sludge would accumulate within the tube and thus reduced the removal efficiency.

For corrugated asbestos cement the sludge could be removed by its own weight more efficient than bamboo tubes. This is because the surface of the corrugated asbestos cement tubes is smoother. So the removal



efficiency at low inclination angle is much more than that obtained from the bamboo tube settlers. However from the results obtained the inclination angle that gave the best removal efficiency for 120 cm-length tube was about 60 degrees. For shorter tubes the angle of 50 degrees seemed to be the best.

#### (4) Effect of Flow Rate on Removal Efficiency

The effect of flow rate on turbidity removal efficiency is shown in Figs. 4.13 - 4.18. It can be seen that the flow rate has much influence on settling performance. The removal efficiency decreases rapidly as the flow rate increases beyond 8.0 m<sup>3</sup>/hr per sq.m of tank surface area. The decrease in removal efficiency due to increase in flow rate is much more significant for shorter tubes than larger tubes for all inclination angles. The tubes diameter had little effect on the change in removal efficiency due to change in flow rate.

For corrugated asbestos cement, the change in removal efficiency due to change in flow rate is less significant than the bamboo tube settlers. For 120 cm tube length and 60 degree inclination angle, the removal efficiency for corrugated asbestos cement decreases from about 94 per cent to 88 per cent when the flow rate was increase from 4 m<sup>3</sup>/hr-m<sup>2</sup> to 12 m<sup>3</sup>/hr-m<sup>2</sup>, while the removal efficiency for 4.0 cm-diameter tube settler decreases from 91.5 per cent to 80 per cent when the flow rate was increased within the same range.

By comparing the results obtained from the experiment with that obtained from CULP, HANSEN, and RICHARDSON's experiment, it can be seen that in CULP, HANSEN, and RICHARDSON's experiment the change in removal efficiency due to change in flow rate was very much dependent on the tube diameter. For the tube length of 2.60 m the removal efficiency for 1.25 cm diameter tube changed from 96 per cent to 87 per cent, when the flow rate was changed from 4.0 m<sup>3</sup>/hr-m<sup>2</sup> to 12 m<sup>3</sup>/hr-m<sup>2</sup>; while for 10 cm-diameter, the removal efficiency decreases from 92 per cent to 46 per cent for the same change in flow rate. For bamboo tubes in the settling tank the diameter had less effect upon the decrease in turbidity removal due to increase in flow rates according to the reasons described before.

The effect of flow rate (expressed in m<sup>3</sup>/hr per sq.m of horizontal surface area of flow) is considered instead of the overflow rate expressed by YAO (1970), i.e.  $v_{sc} = CS_c v_o / (\sin \theta + L \cos \theta)$ . This is because this value of flow rate is more practical in design for a given tank surface area. The expression for the overflow rate is not practical because (a) this expression is based on the assumption that the particles are discrete particles, but for water treatment work, the particle is in the form of floc obtained from the reaction between alum and hydroxyl ions in water; (b) the tube diameter is not uniform along the whole length of tube, and so the value of relative length  $L (= l/d)$  is difficult to find. From the results obtained the diameter had little influence on settling performance and so the value of relative length  $L$  is not the governing parameter for settling performance; (c) for the spaces between tubes the value of critical S-value,  $S_c$ , cannot be accurately estimated. The efficiency of removal within these space are unpredictable, it depends on tube diameter and

clearance between tubes. So the value of overflow rate obtained from YAO's expression has no meaning in tube performance. However, the values of overflow rate for each value of flow rate are calculated by using  $S_c = 4/3$  are shown in Table B-1 in Appendix B. It can be seen that the removal efficiency is not a function of these calculated overflow rate.

#### D. Problems in Using Bamboo as Tube Settlers

Although the experiment shows that the settling efficiency using bamboo as tube settlers is good and the detention time can be reduced to about 10 minutes with more than 80 per cent turbidity removal efficiency, there are some problems occurred due to the properties of the bamboo. These problems are:-

##### (1) Problem Due to Crack Along Bamboo Tube

The bamboo can be easily cracked when it is dry, especially when its nodes are removed. This crack will allow water and settled sludge to flow through and thus reduce the removal efficiency. It can be prevented by keeping the fresh cut bamboo in clean water or in moist room.

##### (2) Space Between Bamboo Tubes

The bamboo tubes are circular and so when they are put into the tank there are space between tubes. The removal efficiency of this space is low because it is not entirely close space and the particles do not settle but flow through the clearance between tubes. This space can be reduced by using straight tubes and carefully setting the tubes in the manner that the space will be minimum.

##### (3) Smoothness of Tube Inside

The smoothness of the tubes also affects the removal efficiency of the tube settlers. From the experience gained from this study it was found that it was rather a hard work to smooth the inside of the bamboo tube especially for small tubes. If the inside is not smooth the sludge will not be able to remove, and so it will accumulate within the tube, which very much reduce the removal efficiency.

##### (4) Problem Due to Organic Matter in Bamboo

This is one of the most serious problem in using bamboo as tube settlers. It was found that when the bamboo was put under water for a few days there would be slime covered the surface of the bamboo tube, especially the inner surface. This slime gave very bad smell and it prevented the sludge removal. This slime is due to the growth of some microorganism using some organic matter released from the bamboo tubes. This organic matter must be removed before using the bamboo as tube settlers. This may be done by putting the bamboo in clean water for a long time or using some chemicals to dissolve the organic matter and so the growth at slime will be prevented.

E. Comparison Between Bamboo Tube and Corrugated Asbestos Cement

The corrugated asbestos cement has now advantages over bamboo tubes on the fact that:-

1. This is no crack due to temperature.
2. Almost every part can be used as tube settlers.
3. Transportation of sludge is more efficient.
4. There is no organic matter and so no problem due to bad smell and organic digestion.
5. It requires less work in preparing.

However the disadvantage of the corrugated asbestos cement is its higher cost and there is still some useless area due to thickness of the plate. Corrugated light weight plastic is thinner and so it is more efficient, however it is much more expensive. From the calculation shown in Appendix C it is found that the construction cost of the bamboo tube settler is about 70 per cent of that of the corrugated asbestos cement tube settler.

## V CONCLUSION

From the results obtained in the experiment and the experience gained in pilot plant study, it can be concluded that:

(1) The length of the bamboo tubes affects the settling efficiency. The longer the tube length the higher the settling efficiency. The decrease in removal efficiency is more significant for shorter tubes. For long tubes, i.e. with the length of 1.20 m or more, the removal efficiency decreases very little. So the tube length is recommended to be in the range of 1.00-1.20 m.

(2) The size of the tube has little effect on the settling performance and so the large tubes with the diameter ranging from 6.0 to 8.0 cm are recommended because it required less work in smoothing the inside and requires less tubes for a given tank surface area.

(3) The inclination angle has little effect on the settling performance. However because of the problem in sludge removal the inclination angle of  $60^{\circ}$  is recommended.

(4) The flow rate is an important factor which affects the settling performance. For the flow rate lower than  $8 \text{ m}^3/\text{hr-m}^2$  the turbidity removal efficiency is more than 80 per cent. The increase of flow rate beyond  $8 \text{ m}^3/\text{hr-m}^2$  will rapidly reduce the removal efficiency. The author recommends that the flow rate should range from 5.0 to  $8.0 \text{ m}^3/\text{hr-m}^2$  in case that 80 per cent of turbidity removed is required.

(5) The value of overflow rate obtained by YAO (1970) is not practical in design purpose especially for bamboo tube settlers.

(6) The temperature also affects the settling performance. It was found that the results obtained in the night time was a little better than that obtained in the day time. This may be because of eddy current due to different between water temperature at the bottom and at the surface of the tank. Another factor is the wind effect which will affect the settling of particles at the part of the tubes near the water surface.

(7) The effect of raw water turbidity is not studied in this experiment, however from CULP and HANSEN (1967) it was found that the removal efficiency increased as raw water turbidity increased but rather a small amount. However the turbidity of the effluent of less turbid water was still lower than that of more rapid water.

(8) The problems in using bamboo as tube settlers include cracks along bamboo tubes; space between bamboo tubes, smoothness of tube inside, and the digestion of organic matter from the bamboo tubes.

(9) The corrugated asbestos cement was found to provide higher removal efficiency than the bamboo tubes under the same operating conditions. There were less problems in using corrugated asbestos cement as tube settlers. The major disadvantage of the corrugated asbestos cement is its higher construction cost and so make it not suitable for rural area.

## VI RECOMMENDATION FOR FURTHER WORK

This study has shown that both bamboos and corrugated asbestos cement can be efficiently used as tube settlers. However there are some problems which require some more detail studying. To obtain more benefits for these two kinds of tube settlers the following recommendations are made for future works.

1. The major problem in using bamboos is the problem concerning organic matter from the bamboos which permit slime growth and so reduce the sludge removal efficiency. Some more detail study should be performed to find the suitable method to dissolve this organic matter.

2. In this pilot plant the bamboos were laid on the wire net which was laid horizontally or steel supports projected from the concrete wall. It was not known whether the flow was uniformly distributed through the whole number of tubes or not. A further study should be performed to find the practical design for the tank so that it will provide uniform flow distribution through the tubes.

3. From the study of the settling performance of corrugated asbestos cement tube settlers, it was found that the removal efficiency is higher than that obtained from the bamboo tube settlers. The major problem is its higher cost, and so, to solve this problem a further study should be performed to find the settling performance of the corrugated asbestos cement laid at some distance apart. This type of arrangement will reduce the number of the corrugated asbestos cement sheet and so reduces the construction cost.

REFERENCES

- AMIN, M.M. (1974), Performance of Tube-Settlers in Clarification of Turbid Tropical Surface Waters, Master's Thesis No 636, AIT, Bangkok.
- CAMP, T.R. (1946), Sedimentation and the Design of Settling Tanks, Trans. ASCE, Vol. III, pp. 895.
- CAMP, T.R. (1953), Studies of Sedimentation Basin Design, Jour. of Sewage Works, Vol. 25, pp. 1.
- CONLEY, W.R. and SLECHTA, A.F. (1971), Recent Experiences in Plant-Scale Application of the Settling Tube Concept, Jour. WPCF, Vol. 45, pp. 1724.
- CULP, G.L. and HANSEN, S.P. (1967), Applying Shallow Depth Sedimentation Theory, Jour. AWWA, Vol. 59, pp. 1134.
- CULP, G.L., HANSEN, S.P. and RICHARDSON, G. (1968), High Rate Sedimentation in Water Treatment Works, Jour. AWWA, Vol. 60, pp. 681-698.
- CULP, G.L., HANSEN, S.P. and STUKENBERG, J.R. (1967), Practical Application of Idealized Sedimentation Theory, Proc. Conf. WPCF, New York City.
- CULP, G.L., HSIUNG, KOU YING, and CONLEY, W.R. (1969), Tube Clarification Process, Operating Experiences, Jour. San. E. Division, pp. 829.
- DRESSER, H.G. (1951), Trays Nearly Triple Settling Tank Capacity, Eng. News Record, Vol. 147, pp. 22.
- FREI, J.K. (1941), Multiple Tray Clarification at a Modern Treatment Plant, Jour. Sewage Work Eng., Vol. 12, pp. 423.
- HAZEN, A. (1904), On Sedimentation, Trans. ASCE, Vol. 53, pp. 45.
- LANGELIER, W.F., Shallow Sedimentation Bains, Jour. AWWA, Vol 22, pp. 1484
- McMICHAEL, F.C. (1972), Sedimentation in Inclined Tubes and Its Application for the Design of High-Rate Sedimentation Devices, Jour. Hydraulic Research.
- ROUSE, N. (1959), Advanced Mechanics of Fluids, John Wiley & Sons, Inc., New York, N.Y.
- STREETER, V.L. (1962), Fluid Mechanics, 3rd Edition, McGraw-Hill Book Co., New York, N.Y.
- THOMAS, J.W. (1958), Gravity Settling of Particles in a Horizontal Tube, Jour. Air Pollution Control Association, Vol. 8, pp. 32.

YAO, K.M. (1970), Theoretical Study of High-Rate Sedimentation, Jour. WPCF, Vol. 42, pp. 221.

YAO, K.M. (1973), Design of High-Rate Settlers, Jour. of the Env. Eng. Division, Oct. 1973, pp. 621.



APPENDIX A

Experimental Results - Optimum Alum Dosage and Optimum pH

Table A1 - Determination of Optimum Alum Dosage by Jar Test Technique

Raw water turbidity 110 JTU      pH 8.60  
Temperature 26°C                      pH adjusted to 6.5

|                            |       |       |       |       |       |       |
|----------------------------|-------|-------|-------|-------|-------|-------|
| Alum Dosage (mg/l)         | 60    | 80    | 100   | 120   | 140   | 100   |
| Effluent Turbidity JTU     | 22    | 18.0  | 15.0  | 9.8   | 7.9   | 6.8   |
| Final pH                   | 6.5   | 6.45  | 6.4   | 6.35  | 6.3   | 6.2   |
| Turbidity Removal per cent | 80.00 | 83.64 | 86.36 | 91.09 | 92.82 | 93.82 |

Table A2 - Determination of Optimum pH Value by Jar Test Technique

Raw water turbidity 1100 JTU      pH 8.60  
Alum Dosage 120 mg/l                      Temperature 26°C

|                             |       |       |       |       |
|-----------------------------|-------|-------|-------|-------|
| Influent pH                 | 6.0   | 6.4   | 6.8   | 7.2   |
| Final pH                    | 5.8   | 6.2   | 6.6   | 6.9   |
| Effluent Turbidity, JTU     | 7.5   | 10.0  | 17.0  | 22.0  |
| Turbidity Removal, per cent | 93.18 | 90.91 | 84.55 | 80.00 |

Table A3 - Determination of Optimum Alum Dosage in the Pilot Plant

Raw water turbidity 110-115 JTU,                   pH 8.50  
pH adjusted to 6.0,                                   Average water temp. 27°C  
Tube length 120 cm, Diameter 4.0 cm, Inclination angle 70°  
Rate of Flow 40 m<sup>3</sup>/hr-m<sup>2</sup>.   Flocculation Time 10 min.   Peddle speed 40 rpm.

|                             |       |       |       |       |
|-----------------------------|-------|-------|-------|-------|
| Alum Dosage, mg/l           | 100   | 120   | 140   | 160   |
| Influent Turbidity, JTU     | 110   | 110   | 115   | 115   |
| Effluent Turbidity, JTU     | 14.0  | 12.0  | 11.0  | 9.0   |
| Turbidity Removal, per cent | 87.27 | 89.09 | 90.43 | 92.17 |
| Final pH                    | 5.80  | 5.80  | 5.70  | 5.60  |

APPENDIX B

Experimental Results - Tube Settler Performance

Table B1 - Turbidity Removal by Tube Settlers

| Run No. | Tube Length cm. | Inclination angle deg. | Tube diameter cm.          | Total flow area m <sup>2</sup> | Total flow rate l/min | Flow rate area m <sup>3</sup> /hr-m <sup>2</sup> | Overflow rate, m <sup>3</sup> /hr-m <sup>2</sup> | Detention time min. | Raw water turbidity JTU | Effluent turbidity JTU | Turbidity removal per cent |
|---------|-----------------|------------------------|----------------------------|--------------------------------|-----------------------|--|--|---------------------|-------------------------|------------------------|----------------------------|
| 1       | 120             | 70                     | 4.0                        | 0.175                          | 11.7                  | 4  | 0.508  | 16.92               | 106                     | 9                      | 91.51                      |
| 2       | 120             | 70                     | 4.0                        | 0.175                          | 23.4                  | 8  | 1.016  | 8.46                | 103                     | 11                     | 89.32                      |
| 3       | 120             | 70                     | 4.0                        | 0.175                          | 35.1                  | 12   | 1.524  | 5.64                | 107                     | 22                     | 79.44                      |
| 4       | 120             | 70                     | 6.5                        | 0.185                          | 12.3                  | 4  | 0.739  | 16.92               | 106                     | 10                     | 90.57                      |
| 5       | 120             | 70                     | 6.5                        | 0.185                          | 24.6                  | 8  | 1.478  | 8.46                | 112                     | 13                     | 88.39                      |
| 6       | 120             | 70                     | 6.5                        | 0.185                          | 36.9                  | 12   | 2.217  | 5.64                | 113                     | 25                     | 77.88                      |
| 7       | 120             | 70                     | 8.5                        | 0.170                          | 11.3                  | 4  | 0.929  | 16.92               | 107                     | 10                     | 90.65                      |
| 8       | 120             | 70                     | 8.5                        | 0.170                          | 22.6                  | 8  | 1.858  | 8.46                | 112                     | 14                     | 87.50                      |
| 9       | 120             | 70                     | 8.5                        | 0.170                          | 33.9                  | 12   | 2.787  | 5.64                | 117                     | 20                     | 75.21                      |
| 10      | 120             | 70                     | Corrugated Asbestos Cement | 0.17                           | 11.3                  | 4  | 0.423  | 16.92               | 113                     | 9                      | 92.03                      |
| 11      | 120             | 70                     |                            | 0.17                           | 22.6                  | 8  | 0.846  | 8.46                | 117                     | 11                     | 90.60                      |
| 12      | 120             | 70                     |                            | 0.17                           | 33.9                  | 12   | 1.269  | 5.64                | 115                     | 20                     | 82.61                      |
| 13      | 120             | 60                     | 4.0                        | 0.18                           | 12.0                  | 4  | 0.386  | 15.66               | 118                     | 10                     | 91.53                      |
| 14      | 120             | 60                     | 4.0                        | 0.18                           | 24.0                  | 8  | 0.772  | 7.83                | 122                     | 12                     | 90.16                      |
| 15      | 120             | 60                     | 4.0                        | 0.18                           | 36.0                  | 12   | 1.158  | 5.22                | 124                     | 24                     | 80.65                      |
| 16      | 120             | 60                     | 6.5                        | 0.20                           | 13.3                  | 4  | 0.528  | 15.66               | 123                     | 10                     | 91.87                      |
| 17      | 120             | 60                     | 6.5                        | 0.20                           | 26.6                  | 8  | 1.056  | 7.83                | 122                     | 14                     | 88.52                      |
| 18      | 120             | 60                     | 6.5                        | 0.24                           | 39.9                  | 12   | 1.584  | 5.22                | 125                     | 27                     | 78.40                      |
| 19      | 120             | 60                     | 8.5                        | 0.185                          | 12.3                  | 4  | 0.673  | 15.66               | 127                     | 12                     | 90.55                      |
| 20      | 120             | 60                     | 8.5                        | 0.185                          | 24.6                  | 8  | 1.346  | 7.83                | 125                     | 15                     | 88.00                      |
| 21      | 120             | 60                     | 8.5                        | 0.185                          | 36.9                  | 12   | 2.019  | 5.22                | 126                     | 26                     | 79.37                      |
| 22      | 120             | 60                     | Corrugated Asbestos Cement | 0.18                           | 12.0                  | 4  | 0.296  | 15.66               | 127                     | 9                      | 93.70                      |
| 23      | 120             | 60                     |                            | 0.18                           | 24.0                  | 8  | 0.592  | 7.83                | 132                     | 11                     | 92.42                      |
| 24      | 120             | 60                     |                            | 0.18                           | 36.0                  | 12   | 0.888  | 5.22                | 126                     | 19                     | 88.10                      |

Table B1 (Cont'd) - Turbidity Removal by Tube Settlers

| Run No. | Tube Length cm. | Inclination angle deg. | Tube diameter cm. | Total flow area m <sup>2</sup> | Total flow rate l/min | Flow rate area m <sup>3</sup> /hr-m <sup>2</sup> | Overflow rate, m <sup>3</sup> /hr-m <sup>2</sup> | Detention time min. | Raw water turbidity JTU | Effluent turbidity JTU | Turbidity removal per cent |
|---------|-----------------|------------------------|-------------------|--------------------------------|-----------------------|--|--|---------------------|-------------------------|------------------------|----------------------------|
| 25      | 120             | 50                     | 4.0               | 0.21                           | 14.0                  | 4  | 0.2652   | 13.77               | 124                     | 12                     | 90.32                      |
| 26      | 120             | 50                     | 4.0               | 0.21                           | 28.0                  | 8  | 0.5304   | 6.89                | 126                     | 15                     | 88.10                      |
| 27      | 120             | 50                     | 4.0               | 0.21                           | 42.0                  | 12   | 0.7956   | 4.59                | 128                     | 33                     | 74.22                      |
| 28      | 120             | 50                     | 6.5               | 0.23                           | 15.3                  | 4  | 0.421  | 13.77               | 130                     | 13                     | 90.00                      |
| 29      | 120             | 50                     | 6.5               | 0.23                           | 30.6                  | 8  | 0.842  | 6.89                | 128                     | 18                     | 85.94                      |
| 30      | 120             | 50                     | 6.5               | 0.23                           | 45.9                  | 12   | 1.263  | 4.59                | 125                     | 31                     | 75.20                      |
| 31      | 120             | 50                     | 8.5               | 0.21                           | 14.0                  | 4  | 0.540  | 13.77               | 124                     | 13                     | 89.52                      |
| 32      | 120             | 50                     | 8.5               | 0.21                           | 28.0                  | 8  | 1.080  | 6.89                | 122                     | 18                     | 85.52                      |
| 33      | 120             | 50                     | 8.5               | 0.21                           | 42.0                  | 12   | 1.620  | 4.59                | 127                     | 33                     | 74.01                      |
| 34      | 120             | 50                     | Corrugated        | 0.20                           | 13.3                  | 4  | 0.233  | 13.77               | 128                     | 9                      | 92.97                      |
| 35      | 120             | 50                     | Asbestos          | 0.20                           | 26.6                  | 8  | 0.466  | 6.89                | 130                     | 12                     | 90.77                      |
| 36      | 120             | 50                     | Cement            | 0.20                           | 39.9                  | 12   | 0.699  | 4.59                | 127                     | 17                     | 86.61                      |
| 37      | 90              | 70                     | 4.0               | 0.175                          | 11.7                  | 4  | 0.621  | 12.69               | 125                     | 12                     | 90.40                      |
| 38      | 90              | 70                     | 4.0               | 0.175                          | 23.4                  | 8  | 1.242  | 6.35                | 122                     | 14                     | 88.52                      |
| 39      | 90              | 70                     | 4.0               | 0.175                          | 35.1                  | 12   | 1.863  | 4.23                | 121                     | 27                     | 77.69                      |
| 40      | 90              | 70                     | 6.5               | 0.19                           | 12.7                  | 4  | 0.944  | 12.69               | 120                     | 13                     | 89.17                      |
| 41      | 90              | 70                     | 6.5               | 0.19                           | 25.4                  | 8  | 1.888  | 6.35                | 122                     | 16                     | 86.88                      |
| 42      | 90              | 70                     | 6.5               | 0.19                           | 38.1                  | 12   | 2.832  | 4.23                | 126                     | 32                     | 74.60                      |
| 43      | 90              | 70                     | 8.5               | 0.175                          | 11.7                  | 4  | 1.175  | 12.69               | 122                     | 13                     | 89.34                      |
| 44      | 90              | 70                     | 8.5               | 0.175                          | 23.4                  | 8  | 2.350  | 6.35                | 123                     | 18                     | 85.37                      |
| 45      | 90              | 70                     | 8.5               | 0.175                          | 35.1                  | 12   | 3.525  | 4.23                | 126                     | 35                     | 72.22                      |
| 46      | 90              | 70                     | Corrugated        | 0.17                           | 11.3                  | 4  | 0.551  | 12.69               | 127                     | 11                     | 91.34                      |
| 47      | 90              | 70                     | Asbestos          | 0.17                           | 22.6                  | 8  | 1.102  | 6.35                | 122                     | 14                     | 88.52                      |
| 48      | 90              | 70                     | Cement            | 0.17                           | 33.9                  | 12   | 1.653  | 4.23                | 125                     | 23                     | 81.50                      |

Table B1 (Cont'd) - Turbidity Removal by Tube Settlers

| Run No. | Tube Length cm. | Inclination angle deg. | Tube diameter cm. | Total flow rate m <sup>2</sup> | Total flow rate l/min | Flow rate area m <sup>3</sup> /hr-m <sup>2</sup> | Overflow rate m <sup>3</sup> /hr-m <sup>2</sup> | Detention time min. | Raw water turbidity JTU | Effluent turbidity JTU | Turbidity removal per cent |
|---------|-----------------|------------------------|-------------------|--------------------------------|-----------------------|--|---|---------------------|-------------------------|------------------------|----------------------------|
| 49      | 90              | 60                     | 4.0               | 0.185                          | 12.3                  | 4  | 0.440   | 11.75               | 123                     | 12                     | 90.24                      |
| 50      | 90              | 60                     | 4.0               | 0.185                          | 24.6                  | 8  | 0.880   | 5.87                | 127                     | 14                     | 88.98                      |
| 51      | 90              | 60                     | 4.0               | 0.185                          | 36.9                  | 12   | 1.320   | 3.92                | 128                     | 25                     | 80.47                      |
| 52      | 90              | 60                     | 6.5               | 0.20                           | 13.3                  | 4  | 0.684   | 11.75               | 127                     | 15                     | 88.19                      |
| 53      | 90              | 60                     | 6.5               | 0.20                           | 26.6                  | 8  | 1.368   | 5.87                | 126                     | 20                     | 84.13                      |
| 54      | 90              | 60                     | 6.5               | 0.20                           | 39.9                  | 12   | 2.052   | 3.92                | 123                     | 34                     | 72.36                      |
| 55      | 90              | 60                     | 8.5               | 0.19                           | 12.7                  | 4  | 0.865   | 11.75               | 128                     | 15                     | 88.28                      |
| 56      | 90              | 60                     | 8.5               | 0.19                           | 25.4                  | 8  | 1.730   | 5.87                | 130                     | 22                     | 83.08                      |
| 57      | 90              | 60                     | 8.5               | 0.19                           | 38.1                  | 12   | 2.595   | 3.92                | 129                     | 36                     | 72.09                      |
| 58      | 90              | 60                     | Corrugated        | 0.18                           | 12.0                  | 4  | 0.389   | 11.75               | 130                     | 10                     | 92.31                      |
| 59      | 90              | 60                     | Asbestos          | 0.18                           | 24.0                  | 8  | 0.778   | 5.87                | 128                     | 14                     | 89.06                      |
| 60      | 90              | 60                     | Cement            | 0.18                           | 36.0                  | 12   | 1.167   | 3.92                | 129                     | 20                     | 84.25                      |
| 61      | 90              | 50                     | 4.0               | 0.215                          | 14.3                  | 4  | 0.349   | 10.33               | 125                     | 15                     | 88.00                      |
| 62      | 90              | 50                     | 4.0               | 0.215                          | 28.6                  | 8  | 0.698   | 5.16                | 127                     | 18                     | 85.82                      |
| 63      | 90              | 50                     | 4.0               | 0.215                          | 42.9                  | 12   | 1.047   | 3.44                | 126                     | 28                     | 77.78                      |
| 64      | 90              | 50                     | 6.5               | 0.225                          | 15.0                  | 4  | 0.550   | 10.33               | 125                     | 17                     | 86.40                      |
| 65      | 90              | 50                     | 6.5               | 0.225                          | 30.0                  | 8  | 1.100   | 5.16                | 125                     | 21                     | 83.20                      |
| 66      | 90              | 50                     | 6.5               | 0.225                          | 45.0                  | 12   | 1.650   | 3.44                | 127                     | 35                     | 72.44                      |
| 67      | 90              | 50                     | 8.5               | 0.20                           | 13.3                  | 4  | 0.702   | 10.33               | 127                     | 18                     | 85.82                      |
| 68      | 90              | 50                     | 8.5               | 0.20                           | 26.6                  | 8  | 1.404   | 5.16                | 124                     | 21                     | 83.06                      |
| 69      | 90              | 50                     | 8.5               | 0.20                           | 39.9                  | 12   | 2.106   | 3.44                | 127                     | 35                     | 72.44                      |
| 70      | 90              | 50                     | Corrugated        | 0.20                           | 13.3                  | 4  | 0.307   | 10.33               | 126                     | 10                     | 92.06                      |
| 71      | 90              | 50                     | Asbestos          | 0.20                           | 26.6                  | 8  | 0.614   | 5.16                | 123                     | 12                     | 90.20                      |
| 72      | 90              | 50                     | Cement            | 0.20                           | 39.9                  | 12   | 0.921   | 3.44                | 125                     | 18                     | 85.60                      |

Cont'd

Table B1 (Cont'd) - Turbidity Removal by Tube Settlers

| Run No. | Tube Length cm. | Inclination angle deg. | Tube diameter cm. | Total flow rate m <sup>2</sup> | Total flow rate l/min | Flow rate area m <sup>3</sup> /hr-m <sup>2</sup> | Overflow rate m <sup>3</sup> /hr-m <sup>2</sup> | Detention time min. | Raw water turbidity JTU | Effluent turbidity JTU | Turbidity removal per cent |
|---------|-----------------|------------------------|-------------------|--------------------------------|-----------------------|--|---|---------------------|-------------------------|------------------------|----------------------------|
| 73      | 60              | 70                     | 4.0               | 0.18                           | 12.0                  | 4  | 0.883   | 8.46                | 127                     | 22                     | 82.68                      |
| 74      | 60              | 70                     | 4.0               | 0.18                           | 24.0                  | 8  | 1.766   | 4.23                | 128                     | 32                     | 75.00                      |
| 75      | 60              | 70                     | 4.0               | 0.18                           | 36.0                  | 12   | 2.649   | 2.82                | 127                     | 50                     | 60.63                      |
| 76      | 60              | 70                     | 6.5               | 0.19                           | 12.7                  | 4  | 1.308   | 8.46                | 128                     | 22                     | 82.81                      |
| 77      | 60              | 70                     | 6.5               | 0.19                           | 25.4                  | 8  | 2.616   | 4.23                | 125                     | 37                     | 70.40                      |
| 78      | 60              | 70                     | 6.5               | 0.19                           | 38.1                  | 12   | 3.924   | 2.82                | 124                     | 52                     | 58.06                      |
| 79      | 60              | 70                     | 8.5               | 0.175                          | 11.7                  | 4  | 1.597   | 8.46                | 123                     | 23                     | 81.30                      |
| 80      | 60              | 70                     | 8.5               | 0.175                          | 23.4                  | 8  | 3.194   | 4.23                | 125                     | 45                     | 64.00                      |
| 81      | 60              | 70                     | 8.5               | 0.175                          | 35.1                  | 12   | 4.791   | 2.82                | 129                     | 62                     | 51.93                      |
| 82      | 60              | 70                     | Corrugated        | 0.17                           | 11.3                  | 4  | 0.788   | 8.46                | 127                     | 19                     | 85.04                      |
| 83      | 60              | 70                     | Asbestos          | 0.17                           | 22.6                  | 8  | 1.576   | 4.23                | 126                     | 27                     | 78.57                      |
| 84      | 60              | 70                     | Cement            | 0.17                           | 33.9                  | 12   | 2.364   | 2.82                | 127                     | 37                     | 70.87                      |
| 85      | 60              | 60                     | 4.0               | 0.19                           | 12.7                  | 4  | 0.637   | 7.83                | 128                     | 22                     | 82.81                      |
| 86      | 60              | 60                     | 4.0               | 0.19                           | 25.4                  | 8  | 1.274   | 3.92                | 122                     | 31                     | 74.59                      |
| 87      | 60              | 60                     | 4.0               | 0.19                           | 38.1                  | 12   | 1.911   | 2.61                | 120                     | 54                     | 55.00                      |
| 88      | 60              | 60                     | 6.5               | 0.20                           | 13.3                  | 4  | 0.972   | 7.83                | 118                     | 25                     | 78.81                      |
| 89      | 60              | 60                     | 6.5               | 0.20                           | 86.6                  | 8  | 1.944   | 3.92                | 122                     | 38                     | 68.85                      |
| 90      | 60              | 60                     | 6.5               | 0.20                           | 39.9                  | 12   | 2.916   | 2.61                | 125                     | 51                     | 59.20                      |
| 91      | 60              | 60                     | 8.5               | 0.185                          | 12.3                  | 4  | 1.212   | 7.83                | 115                     | 24                     | 79.13                      |
| 92      | 60              | 60                     | 8.5               | 0.185                          | 24.6                  | 8  | 2.424   | 3.92                | 117                     | 46                     | 60.68                      |
| 93      | 60              | 60                     | 8.5               | 0.185                          | 36.9                  | 12   | 3.636   | 2.61                | 122                     | 60                     | 50.82                      |
| 94      | 60              | 60                     | Corrugated        | 0.185                          | 12.3                  | 4  | 0.565   | 7.83                | 123                     | 18                     | 85.36                      |
| 95      | 60              | 60                     | Asbestos          | 0.185                          | 24.6                  | 8  | 1.130   | 3.92                | 125                     | 22                     | 82.40                      |
| 96      | 60              | 60                     | Cement            | 0.185                          | 36.9                  | 12   | 1.695   | 2.61                | 124                     | 35                     | 71.77                      |



Table B1 (Cont'd) - Turbidity Removal by Tube Settlers

| Run No. | Tube length cm. | Inclination angle deg. | Tube diameter cm. | Total flow rate m <sup>2</sup> | Total flow rate l/min | Flow rate area m <sup>2</sup> /hr-m <sup>2</sup> | Overflow rate m <sup>3</sup> /hr-m <sup>2</sup> | Detention time min. | Raw water turbidity JTU | Effluent turbidity JTU | Turbidity removal per cent |
|---------|-----------------|------------------------|-------------------|--------------------------------|-----------------------|--|---|---------------------|-------------------------|------------------------|----------------------------|
| 97      | 60              | 50                     | 4.0               | 0.225                          | 15.0                  | 4  | 0.511   | 6.89                | 122                     | 22                     | 81.97                      |
| 98      | 60              | 50                     | 4.0               | 0.225                          | 30.0                  | 8  | 1.022   | 3.44                | 127                     | 30                     | 76.38                      |
| 99      | 60              | 50                     | 4.0               | 0.225                          | 45.0                  | 12   | 1.533   | 2.30                | 126                     | 48                     | 61.90                      |
| 100     | 60              | 50                     | 6.5               | 0.225                          | 15.0                  | 4  | 0.794   | 6.80                | 125                     | 26                     | 79.20                      |
| 101     | 60              | 50                     | 6.5               | 0.225                          | 30.0                  | 8  | 1.588   | 3.44                | 124                     | 37                     | 70.16                      |
| 102     | 60              | 50                     | 6.5               | 0.225                          | 45.0                  | 12   | 2.382   | 2.30                | 122                     | 52                     | 57.38                      |
| 103     | 60              | 50                     | 8.5               | 0.21                           | 14.0                  | 4  | 1.003   | 6.89                | 121                     | 28                     | 76.86                      |
| 104     | 60              | 50                     | 8.5               | 0.21                           | 28.0                  | 8  | 2.006   | 3.44                | 118                     | 46                     | 61.02                      |
| 105     | 60              | 50                     | 8.5               | 0.21                           | 42.0                  | 12   | 3.009   | 2.30                | 124                     | 62                     | 50.00                      |
| 106     | 60              | 50                     | Corrugated        | 0.20                           | 13.3                  | 4  | 0.451   | 6.89                | 126                     | 16                     | 87.30                      |
| 107     | 60              | 50                     | Asbestos          | 0.20                           | 26.6                  | 8  | 0.902   | 3.44                | 127                     | 21                     | 83.46                      |
| 108     | 60              | 50                     | Cement            | 0.20                           | 39.9                  | 12   | 1.353   | 2.30                | 123                     | 29                     | 76.42                      |

APPENDIX C

Cost Comparison Between Bamboo Tube Settler, Corrugated Asbestos  
Cement Tube Settler, and Plain-Sedimentation Tank

The major advantage of the tube settler is that it requires less detention time and thus the volume of the tank can be reduced. This will lower the construction cost. The following cost estimation is made to compare the significance of this advantage between the bamboo tube settler and the corrugated asbestos cement tube settler by comparing with a plain sedimentation tank.

Assumed that the plant is built to serve 10,000 people with water demand of 150 liter per capita per day.

$$\text{Total water demand} = 0.15 \times 10000 = 1500 \text{ m}^3/\text{day}$$

Let the operating hour of the plant be 8 hrs/day

$$\therefore \text{Plant capacity required} = \frac{1500}{8} = 189 \text{ m}^3/\text{hr}$$

#### Plant Sedimentation Tank

$$\text{Detention time required} = 2 \text{ hrs}$$

$$\text{Depth required} = 2.5 \text{ m} + 0.5 \text{ m for sludge storage and clearance}$$

$$\text{Velocity of horizontal flow} \approx 10 \text{ m/hr}$$

$$\therefore \text{Tank volume required} = 189 \times 2 = 378 \text{ m}^3$$

$$\text{Tank surface area} = \frac{378}{2.5} = 150 \text{ m}^2$$

$$\text{Depth} \times \text{Width} \times \text{Flow rate} = \text{Plant Capacity}$$

$$2.5 \times W \times 10 = 189$$

$$W = \frac{189}{25} = 7.56 \text{ m}$$

use 8 m

$$\text{Tank length required} = \frac{150}{8} = 19 \text{ m use } 20 \text{ m}$$

$$\therefore \text{The dimension of the tank is } 20 \times 8 \times (2.5 + 0.5) \text{ m}^3$$

Reinforced Concrete is used. The required wall thick is .20 m

$$\begin{aligned} \therefore \text{Volume of Concrete} &= \{3(2 \times 8 + 2 \times 20) + 8 \times 20 \text{ m}^3\} \times 0.20 \text{ m} \\ &= 65.6 \text{ m}^3 \end{aligned}$$

Concrete cost + labour cost 500 Bt/m<sup>3</sup>  
= 65.6 x 500 = 32800

Form work required in construction = 3 x (20 x 8) x 2 x 2 m<sup>2</sup>  
= 339

Cost of form work + labour cost = 75 Bt/m<sup>2</sup>  
= 75 x 339 = 25425 Bt.

Total cost of the tank = 32800 + 25425

(not included pipe and other equipments) = 58225 Bt.

Corrugated Asbestos Cement Tube Settler

From the results obtained in the experiment, it was found that in order to obtain turbidity removal efficiency higher than 90 per cent the flow rate should not be over 8 m<sup>3</sup>/hr-m<sup>2</sup>. To ensure that the required removal capacity is obtained the flow rate of 5 m<sup>3</sup>/hr-m<sup>2</sup> will be used in the design purpose.

Plant capacity = 189 m<sup>3</sup>/hr

Flow rate = 5 m<sup>3</sup>/hr-m<sup>2</sup>

∴ Area of tube settler required =  $\frac{189}{5} = 38 \text{ m}^2$   
= 3.6 x 10.5 m<sup>2</sup>

From laboratory test it was found that the amount of sludge settled in 1 hr was about 25ml/l of raw water.

Total sludge produced in 1 day = 25 x 10<sup>-3</sup> x 1500 m<sup>3</sup>  
= 37.5 m<sup>3</sup>

Area of tank = 38 m<sup>2</sup>

∴ Required depth for sludge storage = 1 m

The length of corrugated asbestos cement used at the inclination angle of 50 degrees = 1.20 m

The dimension of the tank is shown in Fig. C1 in Appendix C.

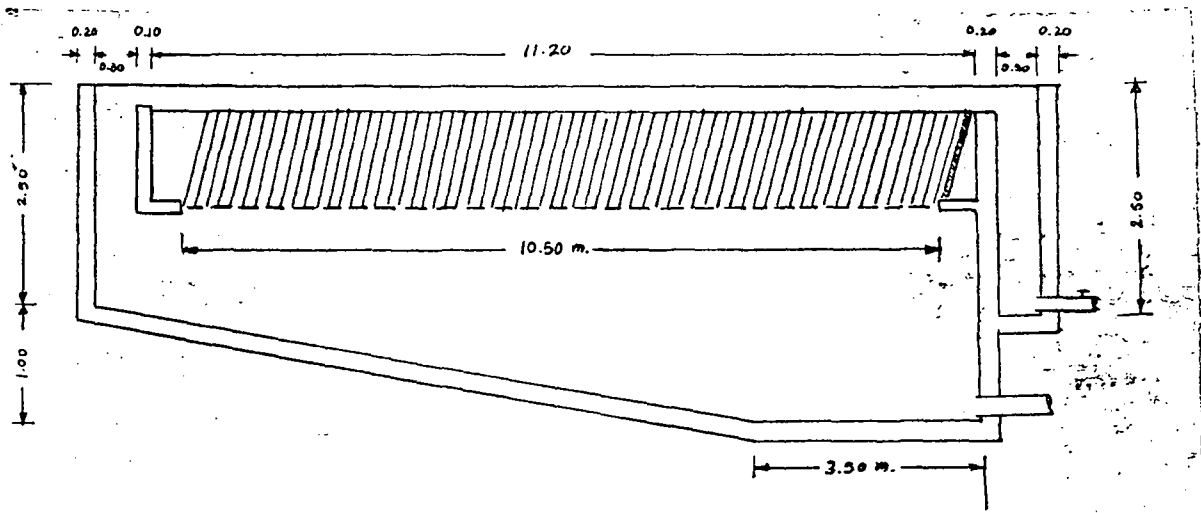

Fig C-1 A Typical Sedimentation Tank With Settling Tubes

|   |   |   |
|---|---|---|
| Volume of Concrete                          | = | $3(3.6 \times 2 + 12.5 \times 2) \times 0.20 + 3.6 \times 12.5 \times 0.20 \text{ m}^3$ |
|   | = | 28.32 $\text{m}^3$  |
| Concrete cost + labour cost                 | = | 28.32 x 500 = 14160 Bt.   |
| Form work required                          | = | $3 \times (3.6 \times 2 + 12.5 \times 2) \times 2 \text{ m}^2$                          |
|   | = | 193.2 $\text{m}^2$  |
| Cost + labour cost                          | = | 193.2 x 75 = 14490 Bt.  |
| Cost of concrete + Form work                | = | 14160 + 14490 = 28650 Bt.   |
| Cost of steel and wire net for tube support | = | 3000 Bt.  |

Determining the cost of corrugated asbestos cement.

Size =  $0.60 \times 1.20 \text{ m}^2$ , thickness  $\sim 0.02 \text{ m}$   
Inclined angle = 50 degree.

Number required for  $0.60 \times 1.00 \text{ m}^2$  = 35

Total no. required =  $6 \times 10.5 \times 35$  = 2205 sheets

Cost = 10 Bt/sheet

Cost of corrugated asbestos cement =  $2205 \times 10$  = 22050 Bt.

Total cost for corrugated asbestos cement tube settler

=  $28650 + 300 + 22050$

= 54700 Bt.

This value is a little lower than the cost of plain sedimentation tank, which is 58225 Baht, and the area required is about 30 per cent of that required for plain sedimentation tank.

#### Bamboo Tube Settler

Assume the flow rate is the same as that used in corrugated asbestos cement tube settler, i.e.  $5 \text{ m}^3/\text{hr-m}^2$

Concrete cost = 14160 Baht

Form work and labour cost = 14480 Baht

Steel and wire for tube support = 3000 Baht

Cost of Bamboo 4 Baht/10 m length

Tube of 1.20 m length is used.

Cost for tube =  $\frac{4}{10/1.20}$  = 0.50 Baht

Labour cost in smoothing 0.50 Baht/tube

∴ 1 tube cost about 1 Bt.

Average outside diameter = 8 cm

Find total number of tube required:

No. of tube per row =  $\frac{3.60}{.08}$  = 45

Inclined angle = 60 degree

∴ No. of row =  $\frac{10.50}{0.80} \times \sin 60$   
= 114 rows  
Total no. of tubes = 45 x 114 = 5130  
∴ Bamboo cost = 5130 x 1 = 5130 Baht  
Total cost for bamboo tube settler = 14160 + 14480 + 3000 + 5130  
= 36770 Baht  
≈ 70 per cent of plain  
sedimentation tank

Summary

|  | Plain Sedi-<br>mentation<br>Tank | Corrugated<br>Asbestos<br>Cement | Bamboo<br>Tube Settler |
|--|----------------------------------|----------------------------------|------------------------|
| Cost of the tank (not<br>included equipments<br>and pipes) | 58225                            | 54700                            | 36770                  |
| Area required (m <sup>2</sup> )                            | 160                              | 52                               | 52                     |