

# UNIVERSITY OF DAR ES SALAAM

51  
3080

FACULTY OF ENGINEERING

DEPARTMENT OF CIVIL ENGINEERING

P.O. BOX 35131 — DAR ES SALAAM — TANZANIA

255.1

82 SL



## REPORT

SLOW SAND FILTER

RESEARCH PROJECT

Report 3

Research Report CWS 82.3

Dar es Salaam, 20.7.1982

11



UNIVERSITY OF DAR ES SALAAM  
Faculty of Engineering  
Department of Civil Engineering  
P.O.Box 35131 - Dar es Salaam - Tanzania

hstg

~~4037~~ (2nd copy) ISN=3088  
255.1 02 SL

SLOW SAND FILTER

RESEARCH PROJECT

Report 3

Research Report CWS 82.3

Dar es Salaam, 20.7.1982

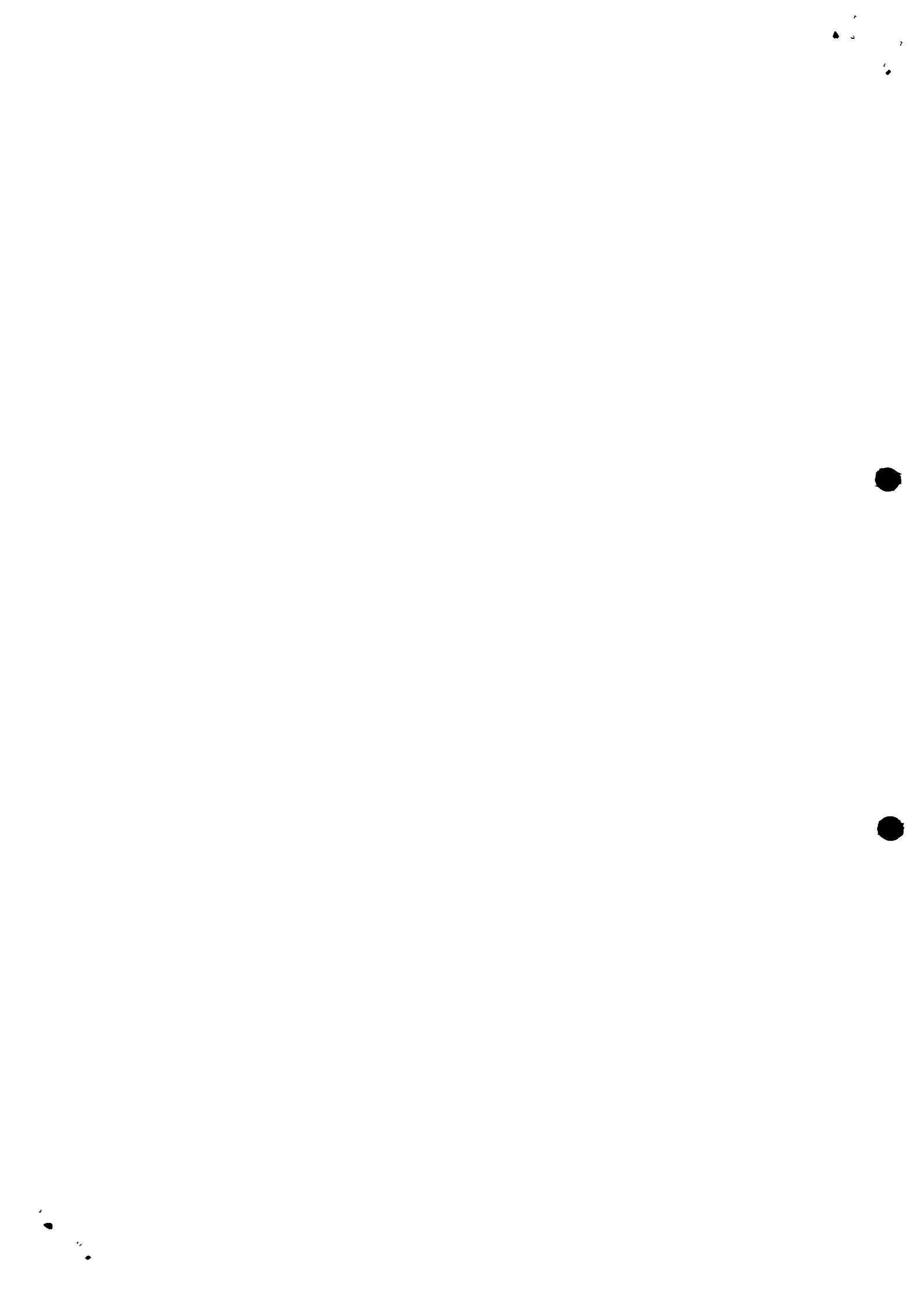

<u>CONTENTS</u>	<u>PAGE</u>
Summary	III
Acknowledgements	IV
1. Introduction	1
1.1 Applicability of Slow Sand Filtration	1
1.2 Objective and Research Programme	2
1.3 Results from Phases 1 and 2	3
2. Field Tests	5
2.1 General Remarks	5
2.2 Filter Models	6
2.3 Test Programme	7
3. Results	8
3.1 Field Tests in Handeni	8
3.2 Field Tests in Wanging'ombe	9
3.3 Field Tests in Iringa	10
3.4 General Conclusions from the Field Tests	12
4. Outlook	13
References	16
Contact Addresses	16
Appendix 1: Realized Research Programme	
Appendix 2: General lay-out of field tests in Handeni and Wanging'ombe	
Appendix 3: Details of the HRF model for Handeni and Wanging'ombe	
Appendix 4: Cross Section through SSF model for Handeni and Wanging'ombe	
Appendix 5: HRF of the pilot plant Iringa	
Appendix 6: SSF of the pilot plant Iringa	
Appendix 7: Executed filtration tests in Handeni, Wanging'ombe and Iringa	
Appendix 8: Filterability Test	
Appendix 9: Jackson Turbidity and Legibility Test	
Appendix 10: Turbidity Reduction with HRF in Handeni	

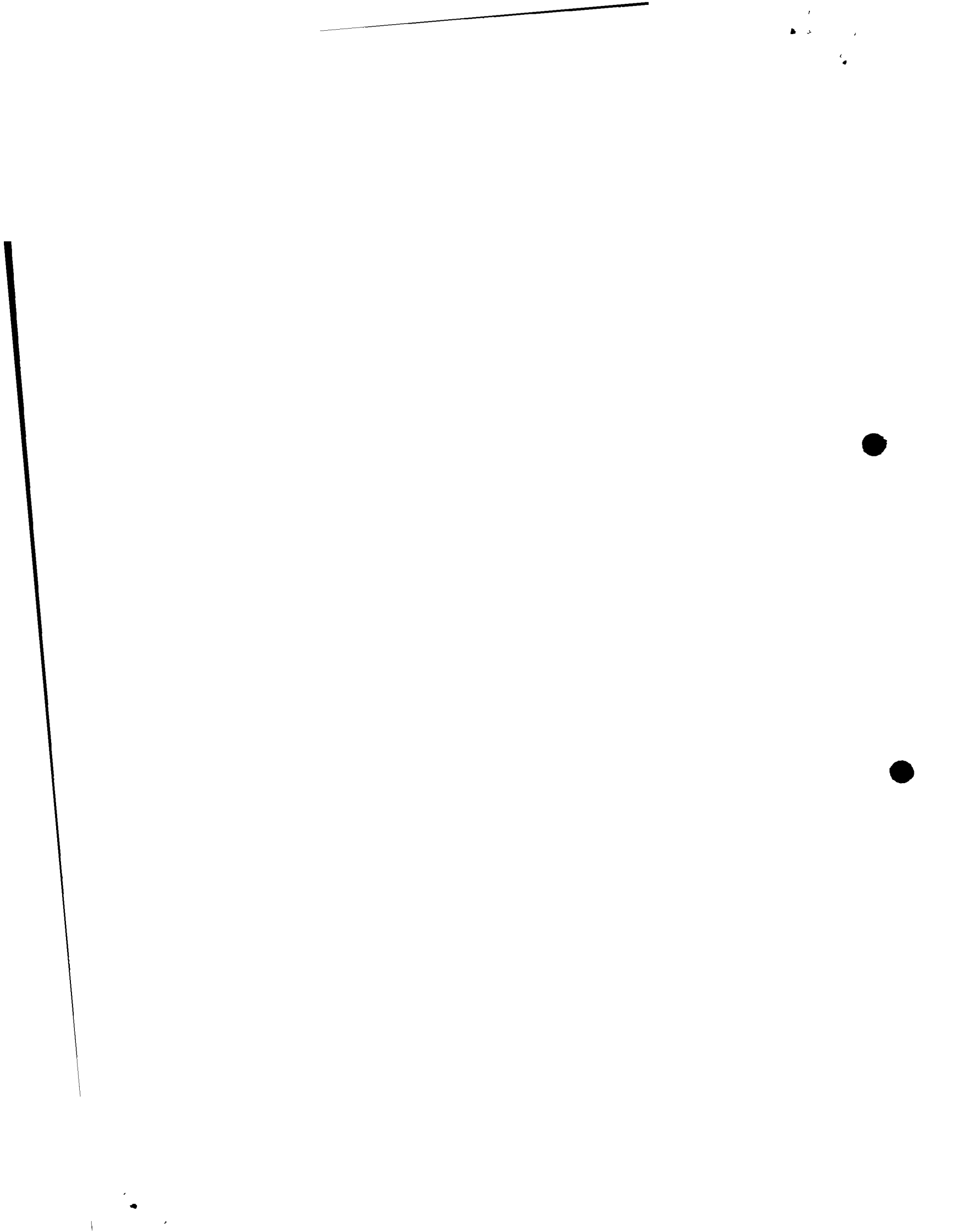

- Appendix 11: Suspended Solids Reduction with HRF  
in Handeni
- Appendix 12: Filter Resistance Development of SSF in  
Handeni
- Appendix 13: Correlation Turbidity - Filterability for  
Handeni water
- Appendix 14: Correlation Turbidity - Legibility for  
Handeni water
- Appendix 15: Filterability Improvement with HRF in  
Wanging'ombe
- Appendix 16: Filter Resistance Development of SSF in  
Wanging'ombe
- Appendix 17: Colour, Turbidity and Legibility of Little  
Ruaha River in Iringa
- Appendix 18: Turbidity Reduction with HRF in Iringa
- Appendix 19: Filterability Improvement with HRF in Iringa
- Appendix 20: Filter Resistance Development of SSF in Iringa
- Appendix 21: Summary of Filter Resistance Development for  
different SSF's
- Appendix 22: Sieve Analysis of used Sand for SSF
- Appendix 23: Provisional Recommendations for the HRF Design
- Appendix 24: Planned Research Programme





Summary

Slow Sand Filtration is a simple but very efficient process used to produce from contaminated surface water a hygienically safe drinking water. However, its application is limited to raw water with low Turbidity and Suspended Solids concentration. In most cases tropical river water must be pretreated prior to Slow Sand Filtration.

The purification capacity of a Horizontal-flow Roughing Filter was tested in the Hydraulic Laboratory of the University of Dar es Salaam. After promising test results also reported from investigations made at the Asian Institute of Technology, Bangkok with a similar filter, the treatment process - Horizontal-flow Roughing and Slow Sand Filtration - was tested in the field at Handeni, Wanging'ombe and Iringa by short-term filtration tests. Slow Sand Filters fed with raw water run for a few days up to 1 - 2 weeks only. With prefiltration the filter runs could be prolonged remarkably.

For the development of proper design guidelines and for the analysis of the long-term performance of the Horizontal-flow Roughing Filter further investigations in the laboratory and in the field are proposed and in progress.

The propagated treatment process consisting of the two filtration steps is considered as a most potential purification method for the treatment of surface waters for rural water supplies in developing countries. The method relies on local resources only for construction, operation and maintenance and hence is independent of foreign inputs such as chemicals etc. Once introduced, the process may have a broad implementation especially in self-help projects.

\_\_\_\_\_

4

\_\_\_\_\_

•

•

1

Acknowledgements

The work presented in this report was carried out in the field at different water treatment plants and under participation of different institutions. Hence, the number of contributors is numerous and not all can be listed here. The project found support with Mr. D.S. Bushaijabwe, Deputy Principal Secretary and Mr. N.K. Msimbira, Head of the Design Section from the Ministry of Water and Energy. A special word of thanks goes to Mr. A.K. Mushi, Regional Water Engineer Iringa and to his staff Messr. E.N. Kiluswa and T. Mfala. The work of Mr. M.M. Riti under the assistance of Messr. P. Rantala and T. Katko from Tampere University of Technology/Finland is much appreciated. The research was supported by a grant from the Tanzanian National Scientific Research Council which was made available by its Director General Prof. N.Y. Kayumbo. Last but not least gratitude is expressed to Prof. E. Trueb from the Swiss Federal Institute of Technology, Zürich/Switzerland who contributed valuable suggestions during the different stages of the project.

Delft/Dübendorf, 20.7.1982



S.A. Mbwette

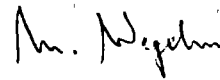

M. Wegelin

Faculty of Engineering  
University of Dar es Salaam

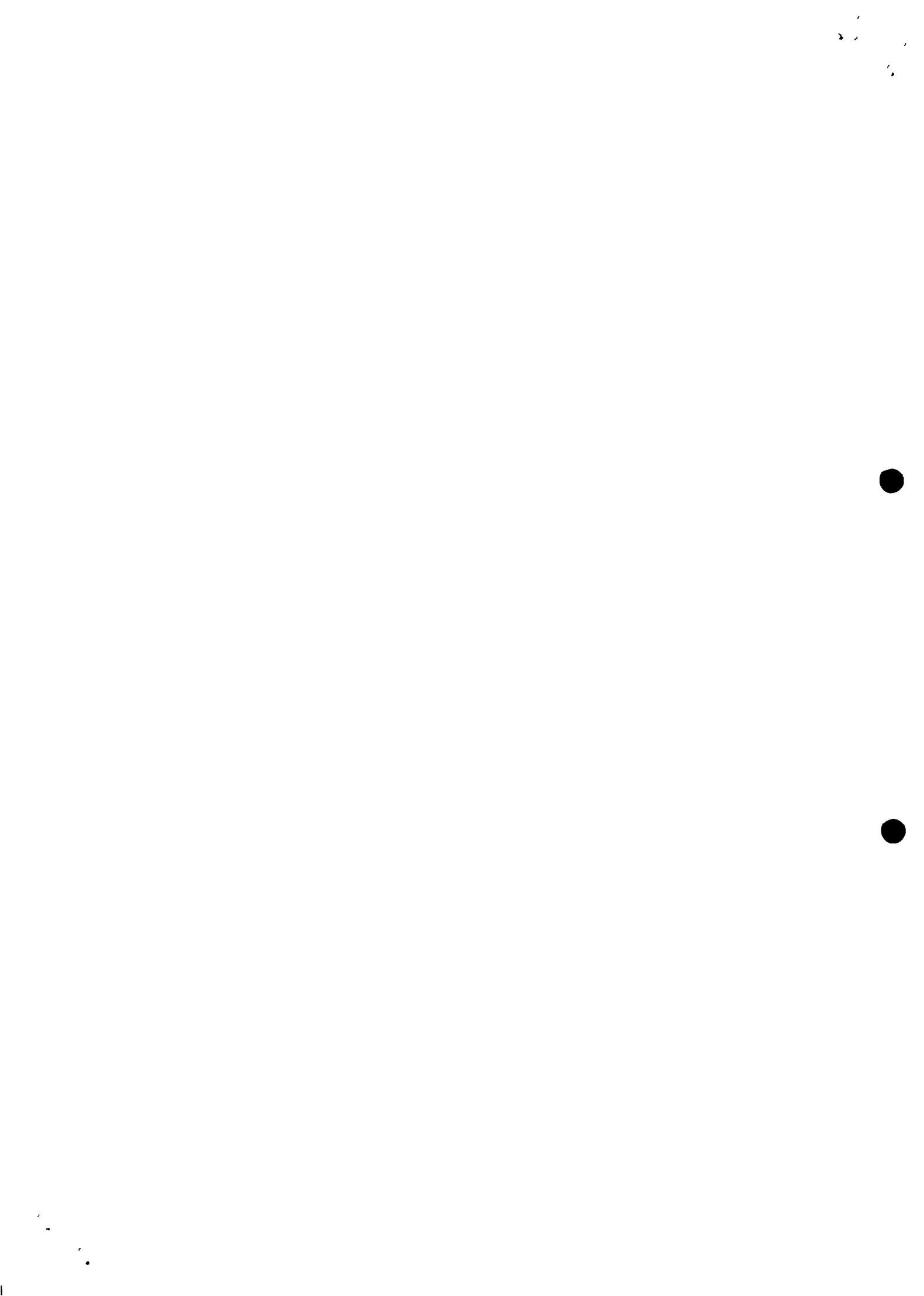

## 1. Introduction

The use of groundwater as a source to meet the domestic and eventually industrial demand is generally limited to areas with potential aquifers only. Where a suitable water bearing aquifer is not available, the consumers will have to rely on surface waters which are in most cases unhygienic and the qualities of which vary considerably throughout the year. Such waters have to be treated before they can be used for domestic purposes. One of the most appropriate method for treatment of surface waters in developing countries is Slow Sand Filtration (SSF). It's suitability stems from it's nature of demanding application of simple operational and maintenance techniques. Slow Sand Filtration is the only water treatment process able to produce hygienically safe water without the use of chemicals.

Slow Sand Filtration is a purification process in which the water to be treated is passed through a porous bed of filter medium. During this process, the water quality improves considerably by reduction of the number of micro-organisms (bacteria, viruses, cysts), removal of suspended and colloidal matter and by changes in it's chemical composition. In a ripe or mature bed a thin layer called the "Schmutzdecke" forms on the surface of the bed. This layer consists of a great variety of biologically very active micro-organisms which break down organic matter while a great deal of suspended matter is retained by straining. The SSF process is essentially distinguished from Rapid Sand Filtration (RSF) by smaller sand size and filtration rate, the Schmutzdecke and the purification processes which take place in this surface layer. The main features of RSF is the removal of relatively large suspended solids by physical processes. Moreover RSF have to be cleaned regularly by a rather complicated backwash operation whereas SSF are cleaned by a relatively simple periodic scrapping off of the top of the filter bed.

### 1.1 Applicability of Slow Sand Filtration

The quality of most tropical surface waters may however limit the applicability of SSF alone and as a result some pre-treatment may have to be applied to the raw water. It has been a common practice to use the criteria of Turbidity in assessment of the suitability for SSF. However, experience from this research has shown that Suspended Solids content and Filtrability are more relevant criterias than Turbidity. The clogging of SSF is caused by particulate matter and algae blocking the fine pores between the sand grains. On the other hand, Turbidity of raw water is not an equivalent parameter because Colour and dissolved minerals have an influence on Turbidity but have none on filter clogging. For SSF, pre-treatment is

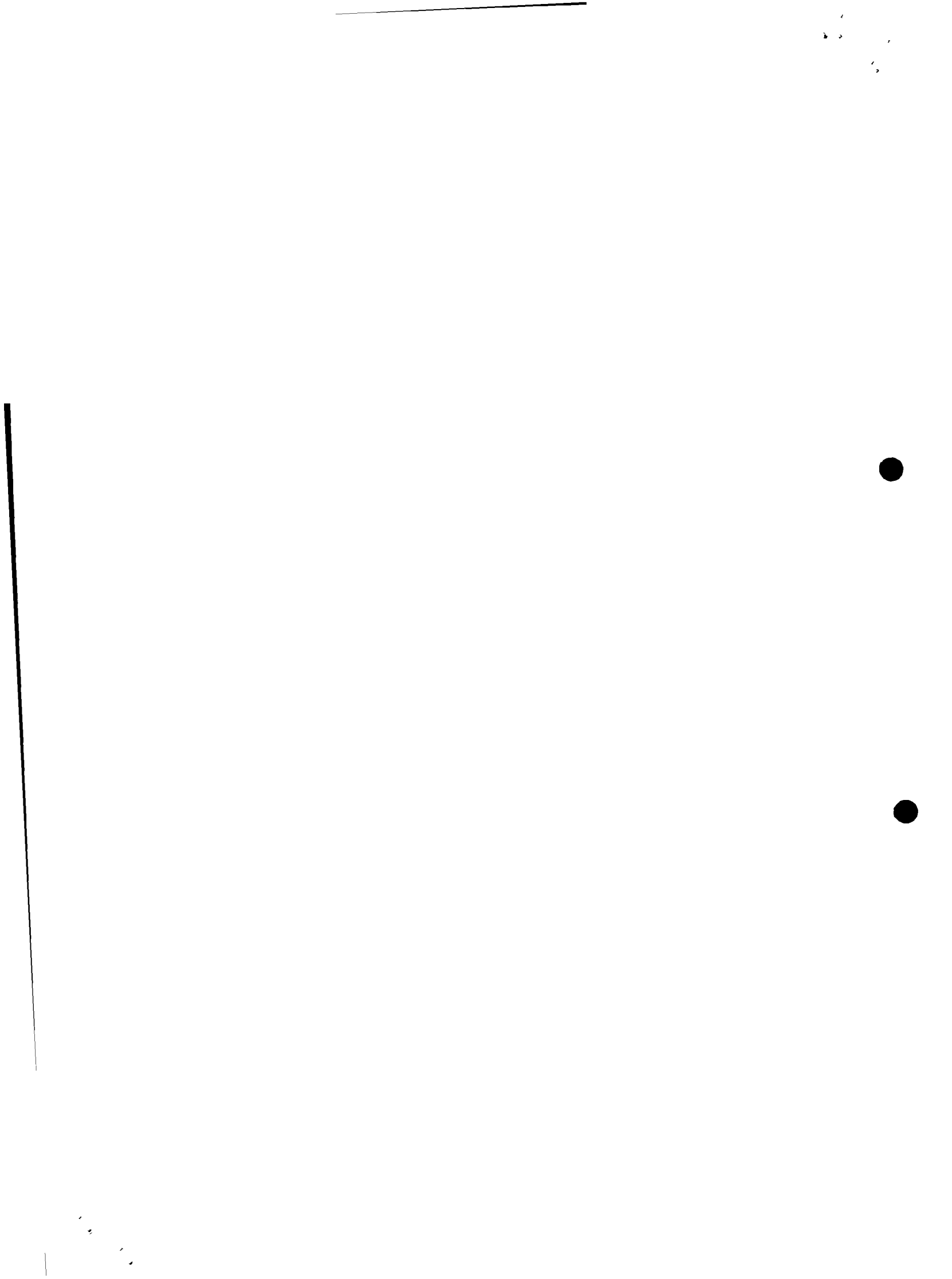

indispensable if the Turbidity of raw water has an average value of more than 30 NTU (Nephelometric Turbidity Unit) for periods longer than a few weeks.

The application of Slow Sand Filters as a water treatment process has hitherto had a bad history in the Tanzanian Water supply schemes. For example slow sand filters constructed in Tabora region (i.e. Igunga, Igurubi, Nkiniziwa and Chamachankola, Ref. 5) are up till now out of operation. Also the operation of the Handeni water supply treatment plant resulted into very short filter runs and hence necessitating regular cleaning of the filters which in turn hinders the development of the much desired Schmutzdecke layer. Similar operational problems have also been reported in most of the slow sand filter schemes treating very turbid raw water in the following provinces of Kenya: Central, Western, Eastern, Nyanze and Rift Valley (Ref. 4).

The findings of the research conducted by NEERI of Nagpur-India in collaboration with the IRC are reported in the IRC-Newsletter No. 123 of July/August 1981. The researchers have come up with a number of worthwhile conclusions regarding the vulnerability of SSF to raw water qualities and intermittent operations. One of their recommendations is that high concentrations of organics and bacteriological pollution in raw water can upset filter performance and hence lead to deterioration of the filtrate quality. The other conclusion discourages the application of intermittent operations of SSF because their investigations showed that the same results to filtrates of unsatisfactory quality. The same researchers have also come up with a more strict limitation of allowable turbidity of raw water influent on SSF of only up to 30 NTU.

### 1.2 Objective and Research Programme

The objective of the research was to develop a simple, self-reliant pre-treatment method for use in conjunction with slow sand filters in Tanzania and other tropical developing countries. The method to be finally adopted was supposed to apply such natural processes (physical and biological) as sedimentation and filtration which are independent from foreign inputs (e.g. chemicals, spare parts).

The research programme for this project is presented in this report as Appendix 1. The programme was divided into three main phases. The first phase involved carrying out a survey and statistical analysis of some relevant water quality parameters for surface waters in Tanzania. The data for this phase was obtained from the central water quality laboratory of MAJI (Ministry of Water and Energy) at Ubungu. The second

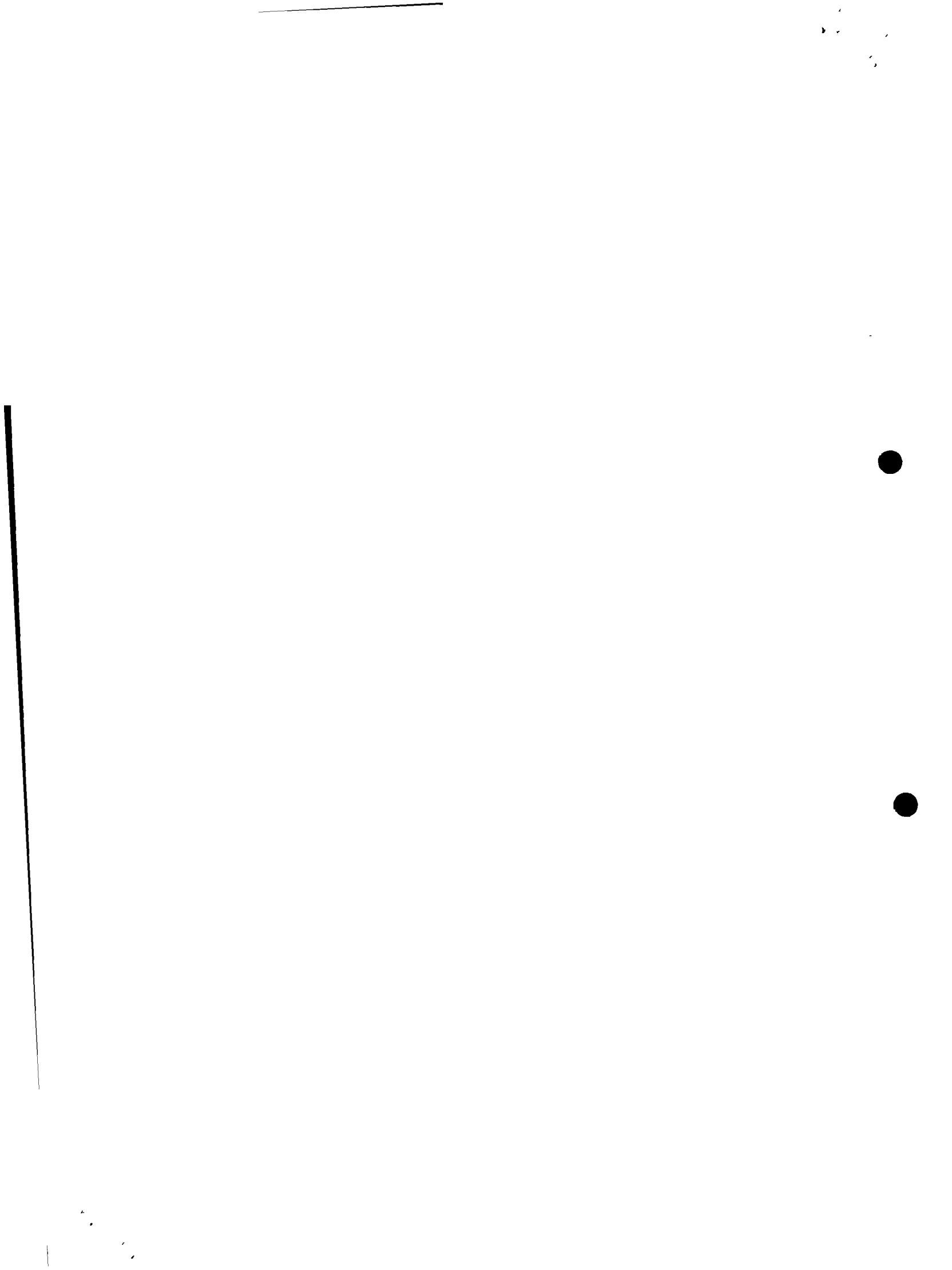



phase covered laboratory tests which led to the choice of the best pretreatment method out of the four tested. The third and hereafter presented phase was basically concerned with checking the validity of laboratory tests carried out in phase 2 in actual field conditions by field tests with pilot plants at Handeni, Wanging'ombe and Iringa. The first phase of the research was carried out from July 1979 to January 1980 (Ref. 1). The second phase was completed in June 1980 (Ref. 2) while the third phase was concluded in September 1981.

### 1.3 Results from Phases 1 and 2

#### 1.3.1 Water quality

The survey of records of water quality parameters from the central water quality laboratory Ubungo and the subsequent statistical analysis of the same enabled to produce this table which gives a summary of the results for wet and dry seasons.

Table 1: Quality of surface waters in Tanzania

PARAMETER	Average $\bar{x}$			67% Limit: $(\bar{x} + \sigma)$	
	Wet season	Dry season	Annual	Wet season	Dry season
Turbidity (JTU)	41	28	35	105	61
Suspended solids (mg/L)	96	42	69	271	92
Sediments (ml/L)	·265	·114	·190	·821	·311
Colour (mg Pt/L)	79	55	67	162	116
KMnO <sub>4</sub> (mg/L)	10.3	6.0	8.2	22.7	10.2
Filterable solids (mg/L)	230	293	262	452	597

( $\sigma$ : Standard Deviation)

The tabulation above clearly documents the variation of water quality with the seasons. Apart from the filterable solids, all the other investigated parameters have higher concentrations during the wet season. It should however be noted that the filterable solids are subject to dilution effect by rainwater which decreases their concentration during the wet season. The annual average turbidity of 35 JTU implicates the necessity of pretreatment before SSF. Although SSF are able to cope with raw waters of turbidities of up to



30 JTU for short periods, satisfactory operation can be guaranteed only if the average turbidity is less than 10 JTU.

The average concentration of suspended solids is above the design guidelines for SSF influents of say a maximum of 5 mg/L. Therefore this emphasises the necessity of pretreatment of most surface waters in Tanzania.

The colour is not much influenced by the seasons because the true colour corresponds to the colour of dissolved substances including those which remain in colloidal solution form. The concentration of dissolved substances is generally not subject to great annual variations. The  $KMnO_4$  values indicate the existence of a relatively small load of organic matter in most surface waters. These small concentrations are favourable for the operation of slow sand filters.

### 1.3.2 Laboratory tests

Four methods of pretreatment were tested in the Hydraulic Laboratory of the University of Dar es Salaam during the second phase (see also Appendix 1). These included plain sedimentation, plain sedimentation aided with inclined lamella plate settlers, vertical roughing filters and horizontal flow roughing filters. After comparing the results, the following conclusions were drawn:

- Sedimentation alone or even if aided by lamella plates will mostly not meet the required raw water standards for SSF influents. If sedimentation is at all to be applied, it should be either for waters without appreciable amount of fine material (e.g. silt, clay, colloids) or in conjunction with chemical flocculation.
- Vertical-flow roughing filters have the same pretreatment efficiency as HRF but are unsuitable for application due to their short filter runs caused by their small silt storage capacity thus necessitating the use of sophisticated equipment and skilled manpower for design, construction, operation and maintenance. Pre-filters cleaned hydraulically might be applied for urban water supplies only.
- Horizontal-flow Roughing Filters (HRF) represent the most appropriate pre-treatment method and should be designed according to the guidelines which will be given hereinafter.
- Its worthwhile to note that at present, the annual costs for HRF are equal to chemical flocculation succeeded by sedimentation. In the near future, the costs of the latter will be higher than the former due to the increasing costs of acquisition of chemicals from abroad in form of foreign currency.

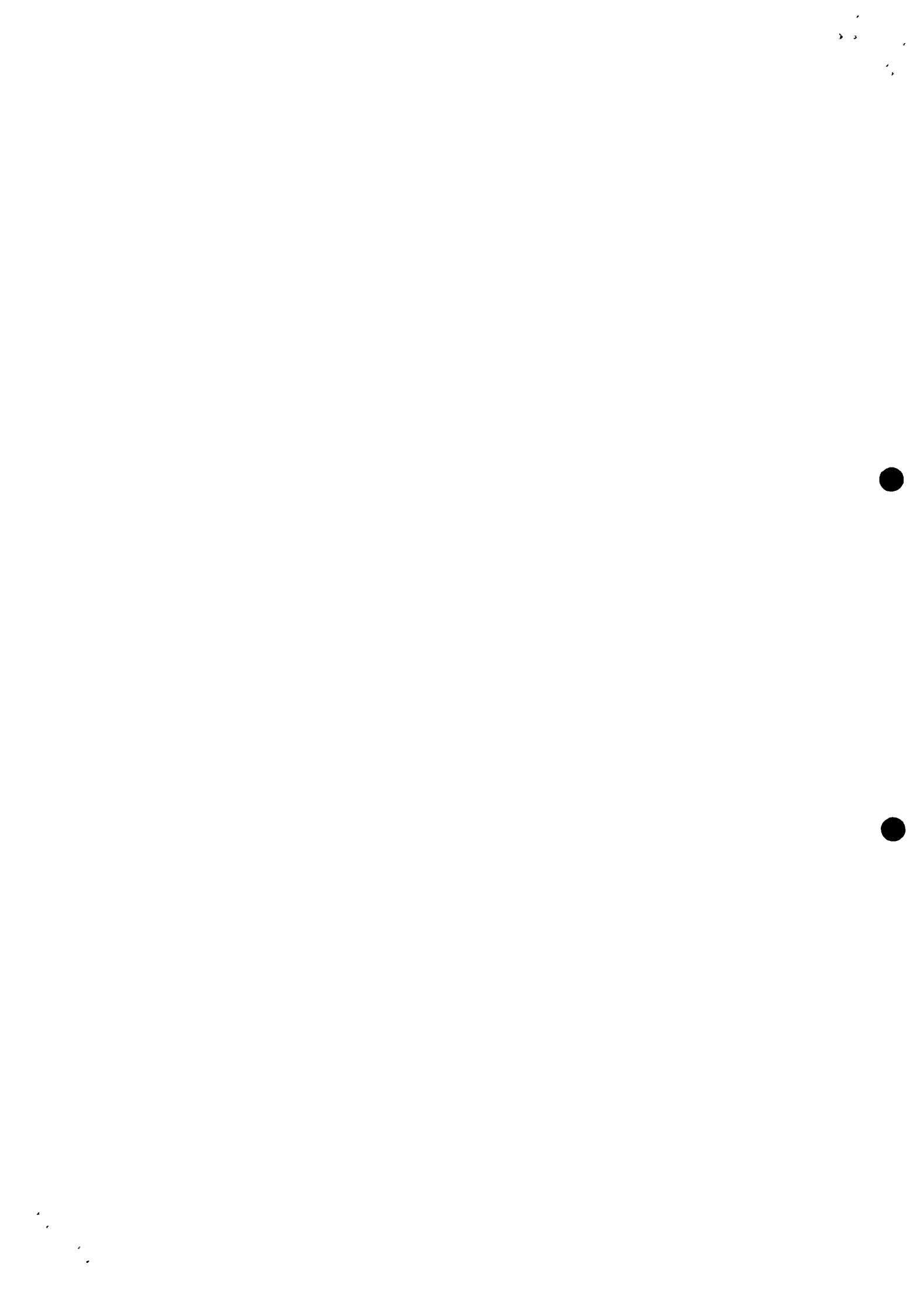

- HRF are wholly based on locally available materials, they are a self-reliant method and independent from foreign inputs of all forms, and hence the most reliable for safe and uninterrupted operation.

On the basis of the filtration tests run in the laboratory the following provisional design guidelines for HRF were recommended:

- The filtration rate should be within the range of 0.5-2.0 m/h. In the first section of the filter where coarser solids will be retained the filtration rate can be chosen at the upper part of the indicated range.
- The filter grains to be used should have three to four fractions with sizes ranging from 2 - 40 mm. The sequence in flow direction should be from coarse to fine.
- The total length of the filter should be around 10 - 15 m and that of the individual fractions approx. 2 - 5 m.

## 2. Field Tests

### 2.1 General Remarks

As mentioned earlier on, verification of the validity of the laboratory tests was to be achieved by carrying out field tests. During the third phase of the SSF Research Project field tests were carried out at the water treatment plants of Handeni, Wanging'ombe and Iringa. Due to time limitation and lack of transport facilities, no field tests were run in Tabora as it was originally planned. For the executed filtration tests water was treated drawn from 3 different rivers draining catchment areas of different geological formations.

Handeni water supply scheme serves about 90'000 people in the rural areas of Tanga Region. It was chosen as one of the field test locations because the recently completed treatment plant which applies SSF as the main purification method has been facing operational and maintenance problems with the pre-treatment unit which comprises dosage of alum sulfate, flocculation and sedimentation. The field tests were carried out by Mr. M. Riti as part of his Master Thesis during the periode of 15.12.80 - 14.1.81 (Ref. 3).

At Wanging'ombe a treatment plant with SSF as the sole treatment process was planned during initial design stages. However, the Design Section of the Ministry of Water and Energy (MAJI) intends now to include a pretreatment step in the plant. The SSF are

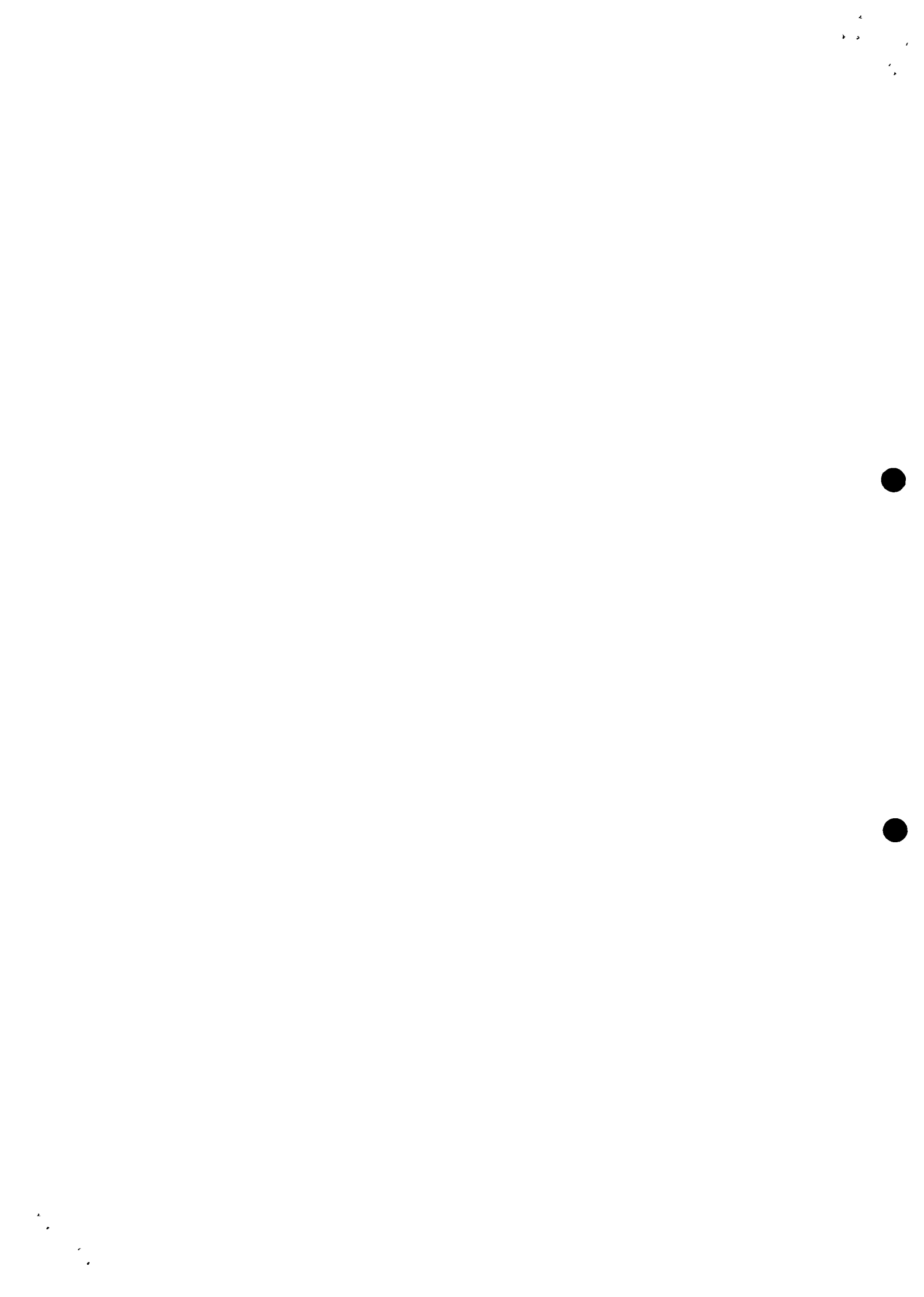

partially constructed and the scheme serves today about 85'000 people with untreated river water which by-passes the treatment plant. The field tests were carried out with interruptions during the period from February until August 81 by MAJI staff members under Mr. E. Kiluswa.

At Iringa, the necessity of extension of the existing urban water supply scheme forced Mr. A.K. Mushi, Regional Water Engineer (RWE) to look into the possibility of using the partially constructed SSF boxes within the pumping station premises in conjunction with HRF. A pilot plant was designed by the University of Dar es Salaam, cofinanced by the Tanzanian National Scientific Research Council with a research grant and constructed by the RWE's office. The CCKK regional water quality laboratory analysed regularly water samples taken from Little Ruaha River and from the pilot plant. The pilot plant was run with interruptions from March up to September 1981.

## 2.2 Filter Models

In principle two different types of filter models were used, the first being a mobile one and using UPVC pipes whereas the second type is built up from concrete blocks on a fixed side.

In Handeni and Wanging'ombe pipes were used for the filter models. The general layouts are sketched in Appendix 2. The first SSF model was fed with filtrate of the HRF, the second and reference SSF model received flocculated water drawn from the supernatant water of the SSF in the case of Handeni or raw water resp. tapped off from the trunk main in the case of Wanging'ombe.

The HRF models were composed of three pipes ( $\emptyset$  250 mm for Handeni,  $\emptyset$  200 mm for Wanging'ombe) and each about 3 m long. These pipes were filled with different gravel sizes and assembled in horizontal position in the sequence "coarse - medium - fine" gravel and sampling points spaced as shown in Appendix 3.

The SSF models were made of pipes  $\emptyset$  250 mm, filled with gravel for the drainage and with sand with the same specifications as for the big SSF boxes. The characteristics of the sand used are listed and graphed on Appendix 22. Transparent piezometer tubes were installed at spacing indicated on Appendix 4.

In addition to the pipe models a bigger SSF model with an inner diameter of about 2.4 m was constructed at Wanging'ombe with cement blocks and filled with gravel and sand layers according to the specifications of the big SSF boxes under construction. This big SSF model was also fed with raw water extracted from the trunk main.

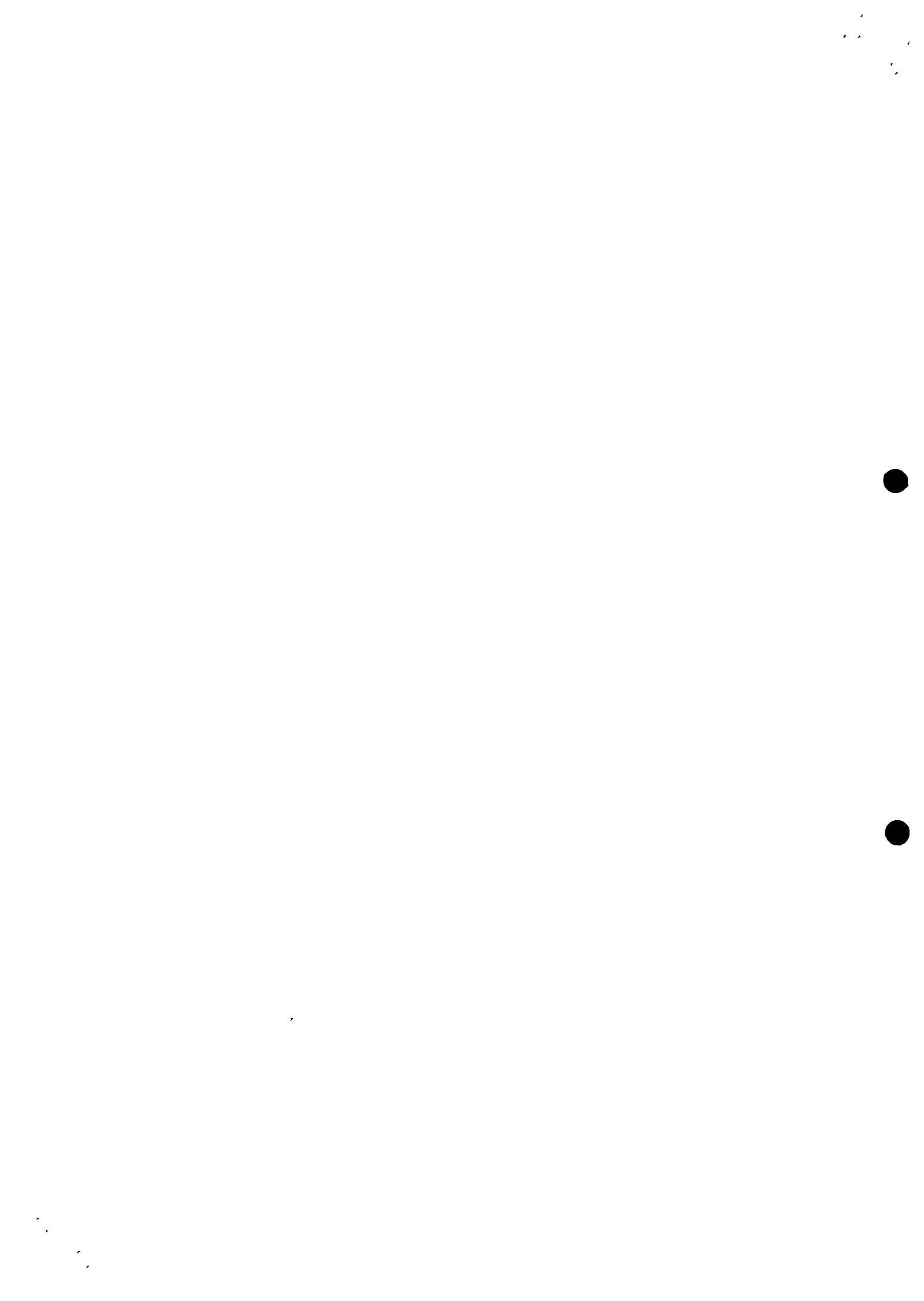



In Iringa the water was pumped from Little Ruaha River to a HRF unit consisting of a sequence of 4 different compartments each with a cross section of 1.60 x 1.30 m and 4 m long, and connected to a pipe system according to Appendix 5. The 4 tanks were filled with broken gravel fractions ranging from  $\emptyset$  32 mm to  $\emptyset$  2 mm. The pretreated water flows by gravity to the SSF which has a filter area of 4 m<sup>2</sup> and which is sketched on Appendix 6. The capacity of this pilot plant limited by the SSF capacity amounts to 20 m<sup>3</sup>/d which was used as additional source for the water supply of Iringa.

### 2.3 Test Programme

As investigations on the performances of the HRF were the main objective of the field tests, the filtration rate of this filter as the most important variable parameter was altered over a range of 0.5 to 5 m/h. Due to time limitations the flow conditions in the HRF were kept constant for only 1-2 days up to a maximum of 3 weeks reflecting the short-term character of the tests.

The SSF models were run at constant filtration rates ranging from 0.2 to 0.4 m/h. The higher rates of 0.3 (Wanging'ombe) and 0.4 m/h (Handeni) were applied to reduce the test time and to simulate in this manner the filter behaviour over a longer period.

The detailed test programmes in respect to duration and filtration rates are tabled in Appendix 7 for the three field test locations. The performance of the HRF in respect to solid separation was assessed by observing the following parameters:

- Filterability by Filtration Tests (see Appendix 8)
- Legibility by Legibility Tests (see Appendix 9)
- Turbidity with Turbiditymeter HACH 2100 A
- Suspended Solids Concentration

Turbidity records are only available for Handeni and Iringa field tests whereas Suspended Solids Concentration could only be determined for some samples taken in Handeni.

For the SSF, the development of the filter resistance was recorded as the most interesting parameter of this research. Some bacteriological tests (E.coli counts) were finally executed for the pilot plant in Iringa.

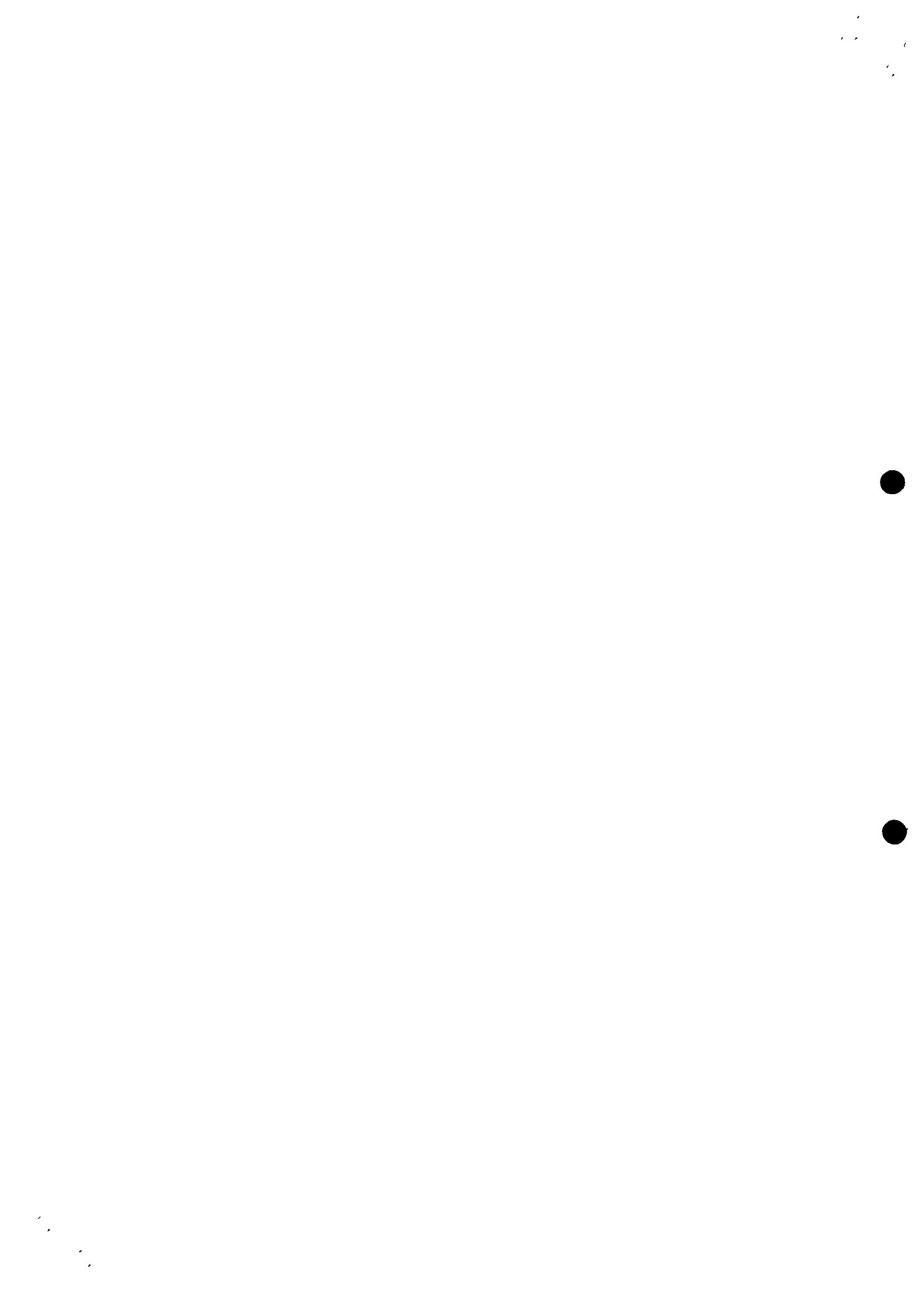

### 3. Results

#### 3.1 Field Tests in Handeni

The reduction of Turbidity along the HRF is graphed in Appendix 10. It clearly indicates the better quality of the filtrate achieved with filtration rates of 0.5 - 1 m/h. At higher flow rates such as 2 and 2.5 m/h Turbidity reduction is reduced in the first 2 gravel fractions of the HRF and is practically not existent in the fine gravel fraction at the end of the HRF. Most of the tests were run with raw water of a Turbidity between 40 and 60 NTU which reflects about average conditions. All gravel fractions contributed to the Turbidity reduction and a filtrate of about 10 NTU could be achieved for the most prospective filtration rates in the range of 0.5 - 1.0 m/h. Remarkable is the performance of the HRF for more turbid water where with an applied hydraulic load of 1 m/h the Turbidity could be reduced from 115 to 25 NTU.

Appendix 11 shows the Suspended Solids removal by the HRF for different filtration rates. The records of the sample taken 17.12.80 reveal a demonstrative picture of the removal efficiencies of the different gravel fractions. Most of the solids are retained in the first part of each section, whereas the second part of the sections were less active. With advanced filtration time this pattern will change to a flat gradient at the beginning of each section (exhaustion of the filter) and steep gradients at the end of the sections. Simultaneously the finer gravel fractions will remove a bigger amount of the solids. Exhaustion of the total filter will occur when no more solids can be retained in each of the gravel fractions. For an ideally designed filter this breakthrough by the solids will be observed at the same time for each gravel fraction.

The filter resistance development of the SSF is graphed in Appendix 12. The reference filter fed with coagulated water and run at 0.2 m/h reached the maximum permissible headloss of 1 m after 3 days. The SSF fed with filtrate from the HRF and run at 0.4 m/h could be operated for 7 days. By applying the observations described by NEERI in World Water, Sept./1979 on the influence of filtration rate variation on the headloss development one can calculate a filter run of 18 days for a filtration rate of 0.2 m/h and of 30 days for a rate of 0.1 m/h. An adverse effect probably affecting the SSF operation time was the observed algal growth in the approx. 60 m transparent hose pipe which connected the SSF with the HRF. In addition the quality of the HRF filtrate fluctuated considerably due to different filtration rates applied to the HRF.

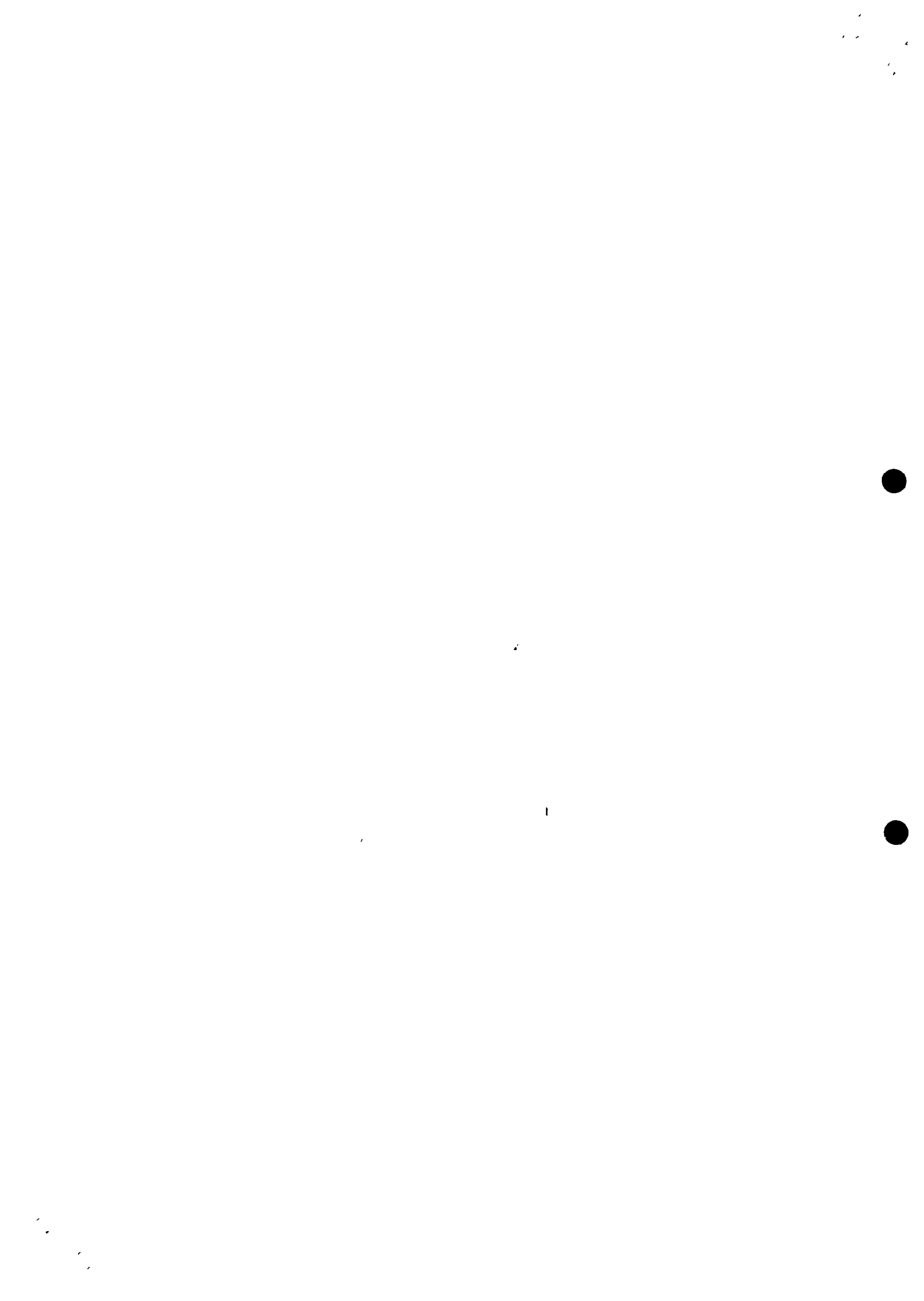

Turbidity must be considered as sum-parameter reflecting different properties of a water. Suspended solids, colloids, colour and dissolved matter do contribute to the Turbidity value. On the other hand the increase in filter resistance of SSF is strongly governed by the solids concentration in the water to be treated. Hence Turbidity as decisive parameter whether a raw water is suitable for SSF or not should be replaced by more appropriate parameters such as for instance the Suspended Solids Concentration. But the determination of the Suspended Solids Concentration is rather troublesome and not feasible under field conditions. Hence a more handy and simpler method was introduced and applied in form of a Filterability Test (see also Appendix 8). The records of Turbidity and Filterability correlated in Appendix 13 document the discussed aspect. Even with Turbidity values of water pretreated with alum sulfate below 10 NTU the Filterability of the water was rather poor with values around 40 mL/Min. The same raw water was treated by HRF. Though the filtrate showed higher Turbidities the Filterability value was about the double of that of the coagulated water and hence more suitable to SSF.

In order to avoid dependency of electrical power and to replace expensive and fragile electronic equipment a Legibility Test was introduced (see also Appendix 9). The correlation between Legibility and Turbidity is shown in Appendix 14. This method alike the Filterability test is not standardized but one can determine relative values which can be used for the efficiency description of a particular plant. The Legibility Test is limited to Turbidities above 10 NTU.

### 3.2 Field Tests in Wanging'ombe

Appendix 15 shows graphically the Filterability improvement of the treated water along the HRF in Wanging'ombe. For the first two gravel fractions this improvement is approximately the same for filtration rates of 0.5 and 1 m/h. The last and fine gravel fraction is not anymore able to increase substantially the Filterability when a filtration rate of 1 m/h is applied, but it still does at 0.5 m/h. Another particularity was recorded for 11<sup>th</sup> March 81 with a filtration rate of 0.5 m/h. A Filterability improvement took place only in the last filter section. Finally the Filterability values were in general much lower in Wanging'ombe than in Handeni or in Iringa. As the Filterability determination method was checked several times without detection of deviations from the method applied at the other two sites the smaller values could be explained by a possibly other shape of the suspended solids due to different geological origin.

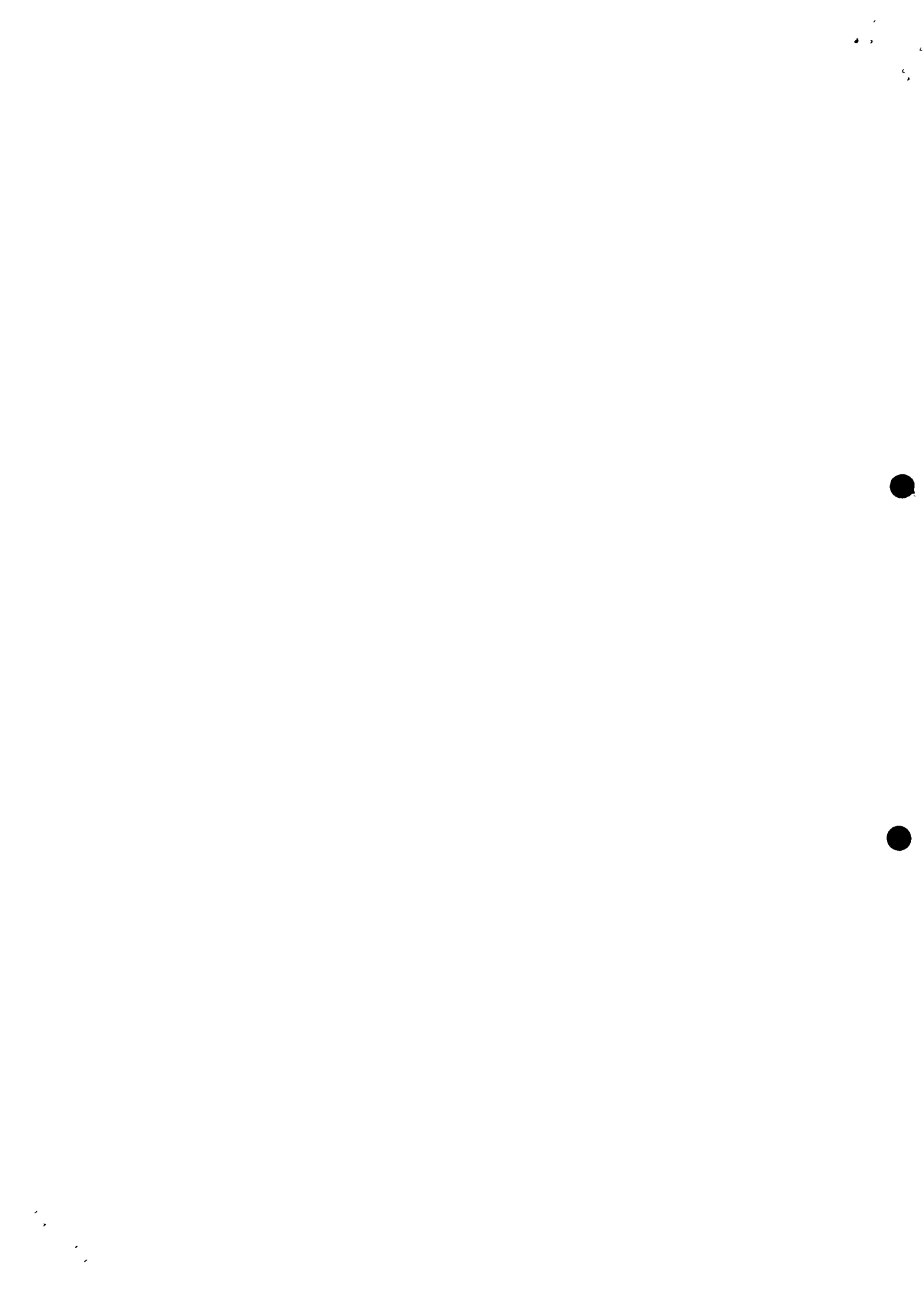

The headloss developments of the different SSF are shown in the left graph of Appendix 16 for the first part of the test period (February-March 81). The SSF model fed with untreated raw water clogged after 15, 7 and 6 days and therefore had to be cleaned 3 times within a running period of 1 month. The other SSF model fed with HRF filtrate developed a filter resistance of only 14 cm at the end of the same period. Both filters were run at a filtration rate of 0.3 m/h. The big SSF operated with interruptions at 0.2 m/h and fed with untreated raw water developed a filter resistance of 89 cm within 33 running days.

A similar pattern was recorded for the test period June-July 81 which is shown in the right graph of Appendix 16. Both, small and big SSF fed with untreated water and run at 0.2 m/h developed a practically identical filter resistance increase. After 34 days the headloss in the big SSF was recorded to 102 cm and hence the filter had to be cleaned. The small SSF fed with HRF filtrate at 0.2 m/h developed in the same period only 11 cm.

Both graphs indicate the necessity to pretreat the river water and document the effectiveness of HRF as pretreatment method. With such a prefiltration filter runs of 3-4 months for the SSF can be anticipated. The tests were executed in a relatively dry period. During the wet season of probably higher Turbidity necessity of pretreatment would become even more apparent.

### 3.3 Field Tests in Iringa

Within the period October 80 and September 81 the CCKK regional water quality laboratory analyzed regularly the water of Little Ruaha River. The records for Colour, Turbidity and Legibility are graphed in Appendix 17. The wet season lasting from December until April is clearly distinguished from the dry season by higher values for Colour and Turbidity and lower ones for the Legibility.

Appendix 18 illustrates the Turbidity reduction along the HRF. In the initial stage of operation the Turbidity was scarcely reduced which could be caused by the dusty gravel - mechanically broken gravel was used - or by electrostatic repulsive forces on the surface of the gravel which were reduced during filter operation. The raw water Turbidity was recorded to about 60 NTU during the period April-June 81 (graph 18/1) and to about 40-55 NTU for the period July-September 81. In general the Turbidity of the HRF effluent was not much influenced by the filtration rates applied (0.5 - 5 m/h). Moreover most of

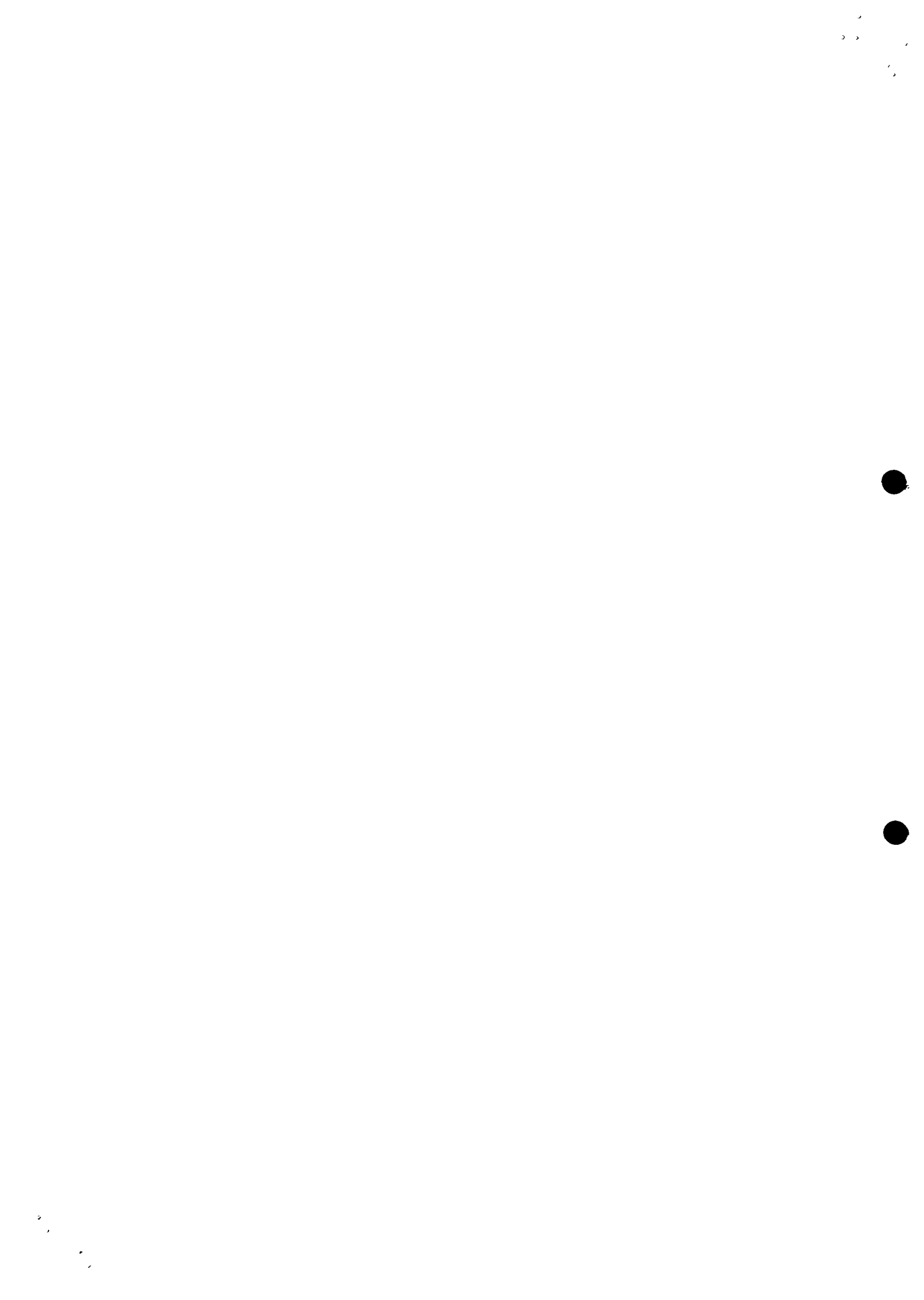



the reduction took place in the first two compartments with aggregates of  $\emptyset$  16-32 mm and  $\emptyset$  8-16 mm. Thus the two following compartments filled with aggregates of  $\emptyset$  4-8 mm and  $\emptyset$  2-4 mm resp. had a buffering effect, at high filtration rates the Turbidity was further reduced whereas for small filtration rates the water quality improvement with respect to Turbidity was not remarkable anymore.

In the case of using only these two last gravel fractions the HRF produced an effluent of the same Turbidity. Finally it is remarkable that the Turbidity of about 20-30 NTU from the HRF filtrate was not further reduced by the SSF, even when the coarse sand used in the first part of the test period was replaced by an approx. 20 cm thick top layer of finer sand (see also Appendix 22). Most probably this final Turbidity was caused by truly dissolved matter.

As shown in Appendix 19 the Filterability of the raw water was around 40 to 60 ml/Min for the period April-June 81 and between 50 and 70 ml/Min in the period July-September 81. The respective values for the HRF filtrate varied widely for the first period due to circumstances described above. A rather uniform picture nearly independent from the applied filtration rate of 1.5 - 5 m/h can be observed for the second period. The Filterability of the HRF effluent was recorded to 100-120 ml/Min for this test period. The treatment by SSF increased this value by 10 to 20 ml.

On the basis of the observed performance of the HRF indicated as Turbidity reduction and Filterability increase one is not yet able to indicate the optimum filtration rate to be applied and which gravel sizes to what filter length should be installed. Further investigations are necessary also to monitor the long-term performance of the HRF.

The SSF was initially filled with rather coarse sand with a specific diameter of 0.62 mm (see also Appendix 22). The filter resistance increase was very small and recorded to be about 10 cm after an operation time of 68 days. The 20 cm top-layer of the sand was replaced by finer sand with a specific diameter of 0.23 mm by the end of May 81. For the subsequent filtration test the headloss development of the SSF is graphed on Appendix 20. After 3 weeks of operation a filter resistance of about 15 to 20 cm was recorded. The SSF was operated at a constant filtration rate of 0.2 m/h throughout the test periods.

Finally several E.coli counts were executed by the membrane filtration technique. In September 81 the river water had a level of about 300-400 E.coli/100 mL, in the HRF filtrate around 100 E.coli/100 mL were detected and none was found in the effluent of the SSF.

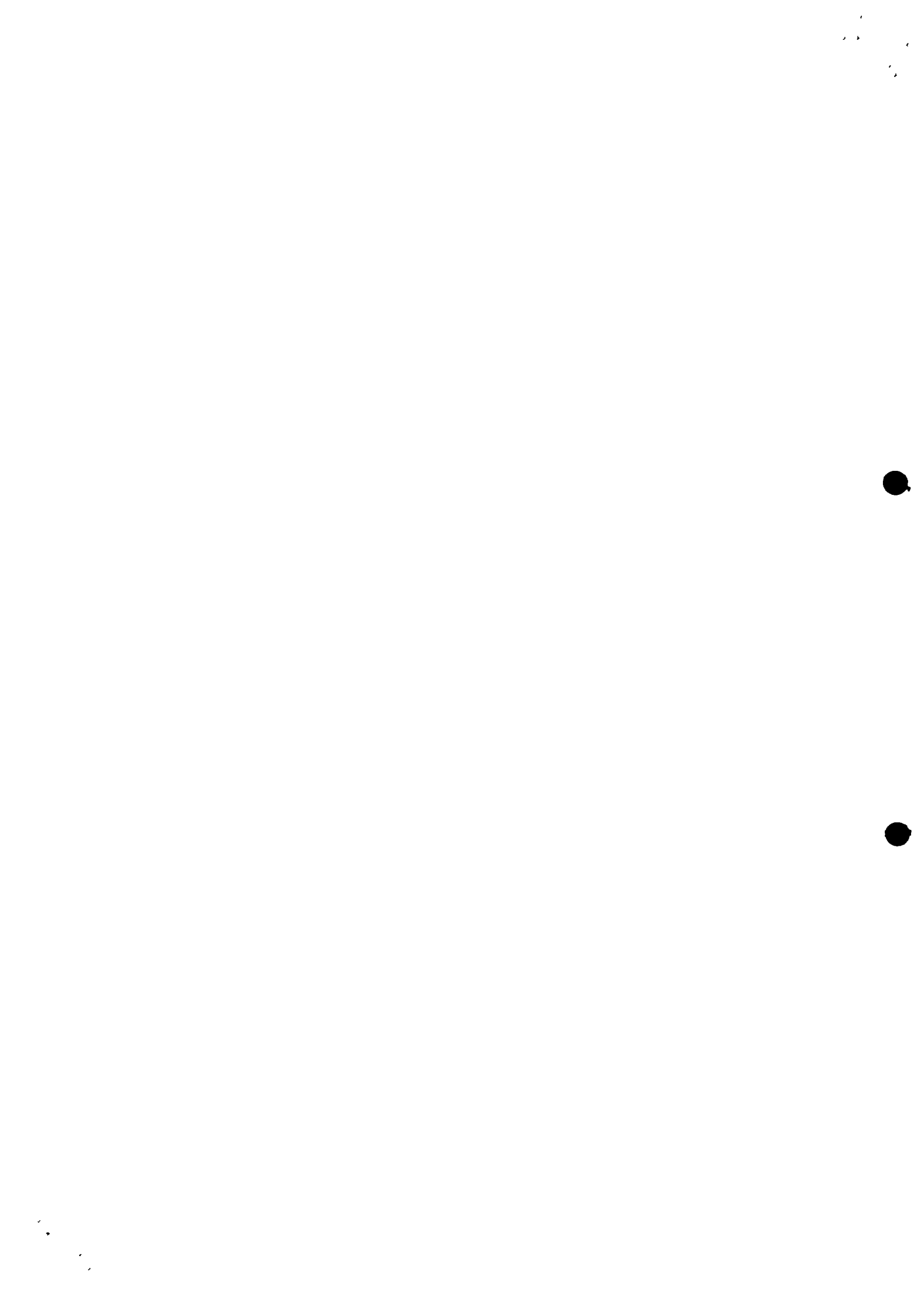

### 3.4 General Conclusions from the Field Tests

The main purpose of the HRF is the physical treatment of the raw water by separation of the solid material from the raw water and to prolongue in this way the usable running period of SSF which is exhausted when the maximum allowable headloss is built up in the sand filter bed. The filter resistance development of the different field tests are summarized in Appendix 21. Note the logarithmical scale of the time axis.

The graphs indicate drastically that SSF cannot be applied without pretreatment of the tested river waters. The respective filter runs last from a few days up to 2-3 weeks, a reasonable operation time for SSF should not be smaller than 2-3 months. This, in order to reduce the operational costs which are mainly expenditures for filter bed cleaning and to enable the production of bacteriologically safe water which starts only after a ripening period lasting from a few days to 1-2 weeks.

In the case of raw water pretreatment by HRF the filter run period of the SSF could be prolonged considerably. In the case of Handeni this period was increased by a factor 6. However, an operational time of 18 days is still too short for a reasonable SSF operation. Besides the use of a rather fine sand with a specific  $\phi$  of 0.24 mm algal growth in the long transparent hose pipe and quality fluctuations in the HRF effluent due to test conditions were adverse effects shortening the operational time of the SSF. Before a possible installation of HRF in Handeni these aspects must be carefully investigated by some more preferably long-term filtration tests.

In the case of Wanging'ombe and Iringa the situation is much more favourable. After a filtration time of about 1 month a filter resistance of approximately 20 cm was recorded. Observations of long-term tests are not available. By extrapolation of the respective graphs a filter run period of 2-6 months can be anticipated which should be proved by long-term filtration tests.

A central role in the headloss development must also be attached to the applied size of the sand in the SSF. Fine sand tends to a quick headloss increase, coarse sand does the opposite. Hence, the use of coarser material would be more favourable. However, the filtration might well change from a surface to a deep bed filtration in which initial advantages could be turned down to serious disadvantages. A thicker sand layer must be scrapped off for the removal of the retained solids or under worst conditions the accumulation of solids in the deeper part of the filter bed can reach such an extent to clog the filter completely. An investigation on the penetration depth as function of sand size, filtration rate and size of the retained

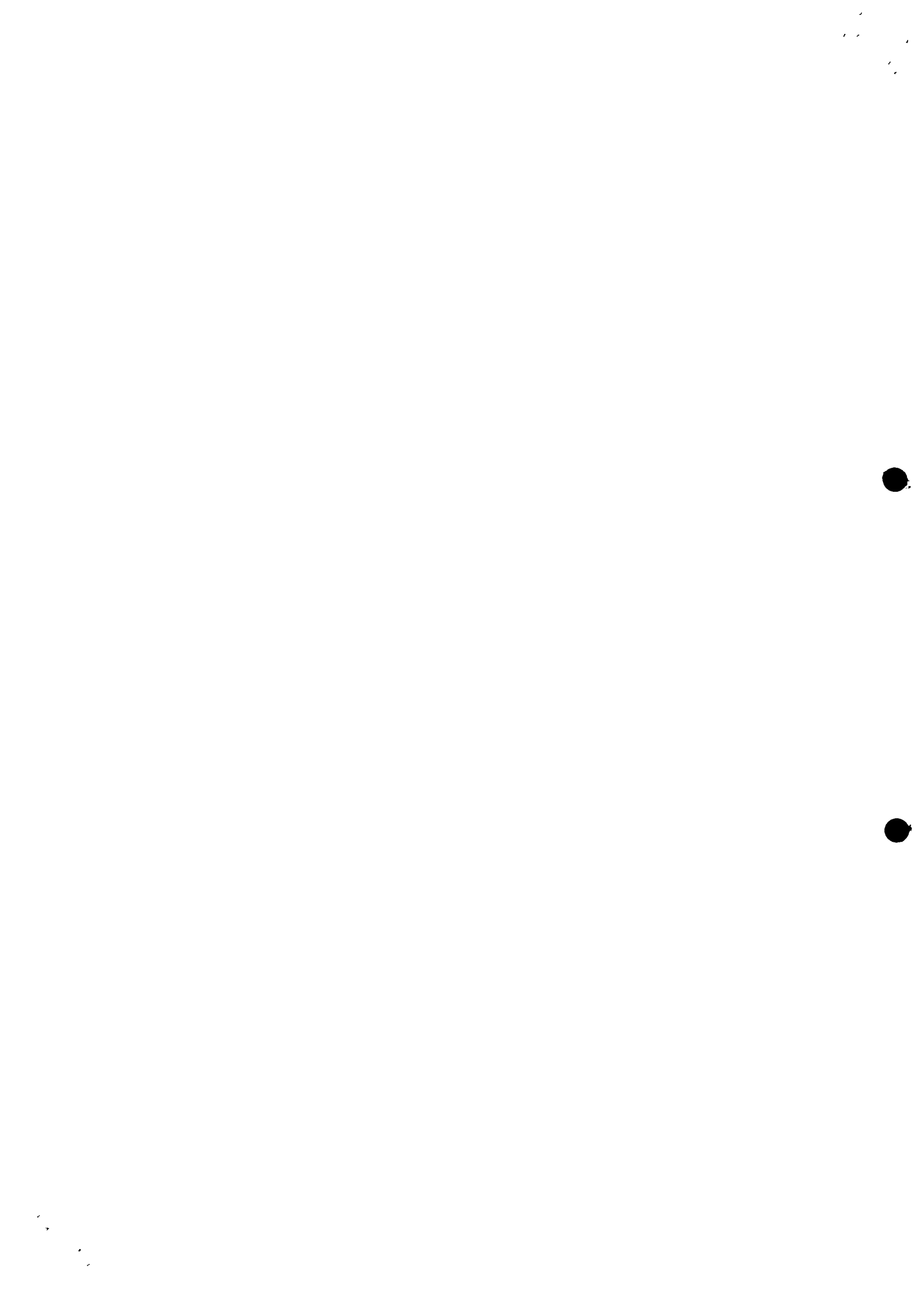

solids is recommendable. Before more information on these aspects is available it is advisable to stick to the in the literature recommended figures of 0.15 to 0.35 mm for the specific  $\phi$  of the sand.

Concerning the design of HRF, a filtration rate of about 1 m/h seems to be appropriate for Handeni and Wanging'ombe. The same can be increased to 2 m/h or more for the HRF in Iringa. The use of 3 gravel fractions ranging from 32 evtl. 16 mm down to 4 mm with a total filter length of about 9 to 12 m seems to be reasonable. The discrepancy for the different filtration rates might be caused by the different models used (small tubes versus a full scale plant) and by eventually different chemical properties (calcium concentration, alkalinity, humic acids) of the raw water. Finally the long-term behaviour of the HRF is not yet investigated.

The Asian Institute of Technology in Bangkok tested also HRF with Laboratory and Field Tests (Ref. 8). A HRF with 7 different gravel fractions ranging from  $\phi$  9-20 mm to  $\phi$  2.5-6 mm and a total filter length of 5 m was operated in the field at a constant filtration rate of 0.6 m/h. The Turbidity could be reduced by the HRF from about 60 JTU to about 10-20 JTU. The SSF with an effective sand  $\phi$  of 0.25 mm and a filtration rate of 0.15 m/h developed a filter resistance of 57 cm after 55 days of continuous operation. After these successful tests several small treatment plants on village level were built and are apparently now in operation. The experiences made in Thailand prove the viability of the propagated treatment process also for probably different water qualities.

#### 4. Outlook

A SSF Seminar organized by MAJI and the University of Dar es Salaam was held on the 25<sup>th</sup> September 81 in Iringa. Some 40 participants mainly from the Regional Water Engineers Offices attended the workshop and were introduced in the techniques of HRF and SSF. After a visit of the pilot plant the participants convinced about the appropriateness of the presented water treatment process formulated a Resolution in which it was stated that

- Slow Sand Filtration combined with Horizontal-flow Roughing Filtration as pretreatment process is considered as an appropriate and self-reliant water purification technique highly suitable for rural water supplies in Tanzania

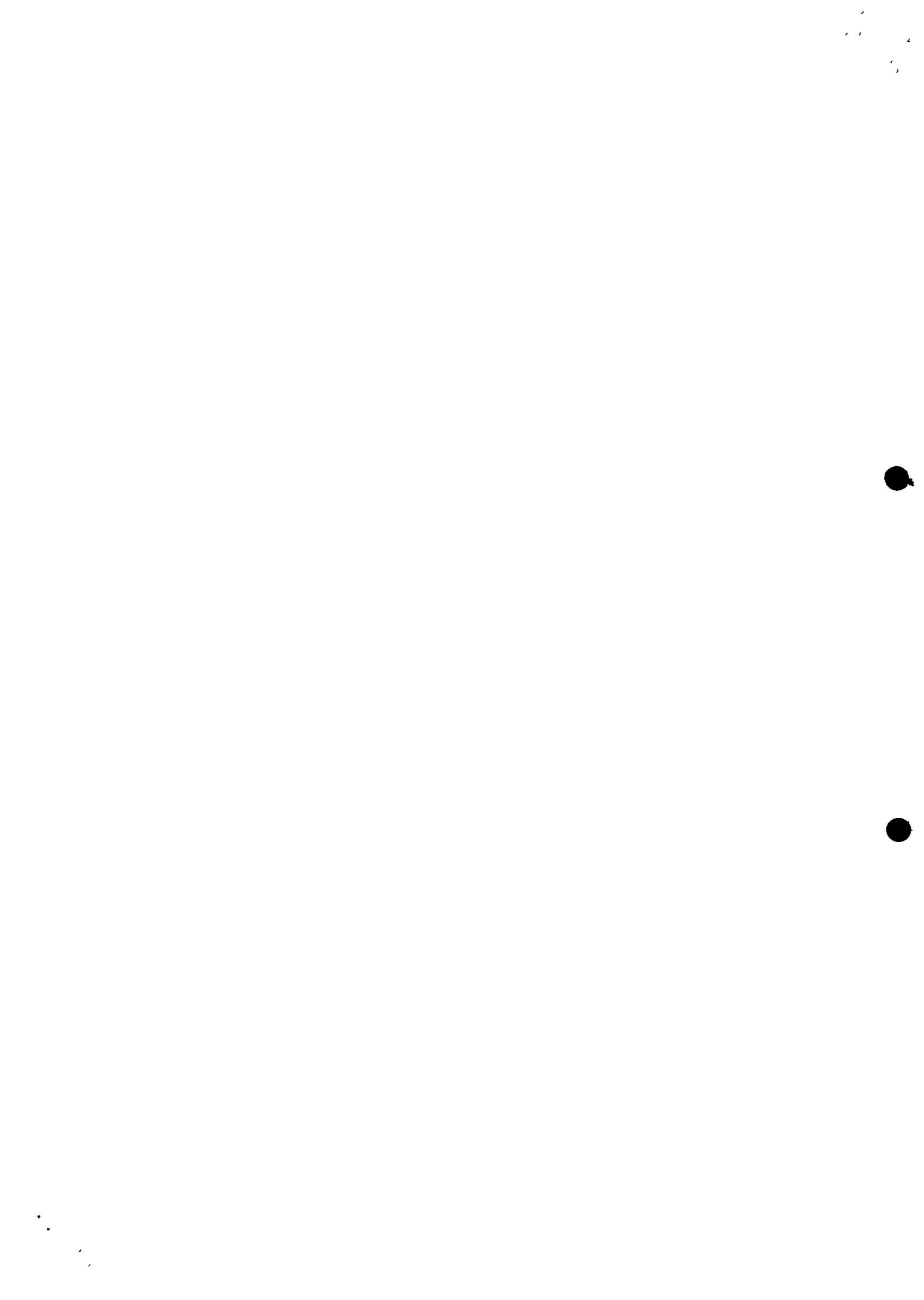

- within the efforts of the International Water Supply and Sanitation Decade this treatment process should be widely applied in Tanzania
- the Ministry of Water and Energy, the University of Dar es Salaam and the Tanzanian National Scientific Research Council should cooperate and execute some more research on this treatment process.

The field tests clearly proved the suitability of the HRF as pretreatment method for SSF. It is true that deviations in the performance of the different field test models were observed and that secured design guidelines for the sound lay-out of HRF are not yet available. Furthermore the long-term performance of the HRF remains to be investigated. On this actual state only provisional recommendations for the design of HRF can be given. They are summarized in Appendix 23.

In these circumstances additional activities were planned and proposed as are shown in Appendix 24. The programme covers a periods of 2½ years (February 82 - July 84) and is set up as joint project between

- IRCWD at EAWAG in Dübendorf/Switzerland  
(IRCWD: International Reference Centre for Waste Disposal  
EAWAG: Federal Institute for Water Resources and Water  
Pollution Control)
- the Faculty of Engineering at the University of Dar es Salaam/Tanzania
- the Tanzanian Ministry of Water and Energy, Dar es Salaam/Tanzania.

The first column of Appendix 24 lists the activities planned in Switzerland. Essentially the work concentrates on filtration tests in the laboratory for the process investigation of HRF. Sophisticated instruments such as Coulter Counter for the determination of size and number of suspended solids will be used.

The second column describes the planned work of Mr Mbwette, Academic Staff Member at the Faculty of Engineering. The central part of his work consists of the execution of additional filtration tests at the pilot plant in Iringa. These tests should reinforce the results obtained in the laboratory.

The third column indicates the planned cooperation of MAJI. It is anticipated that different Regional Water Engineers will individually apply the propagated treatment process on small scale level for village water supplies. This can be done in form of self-help projects as only locally available material

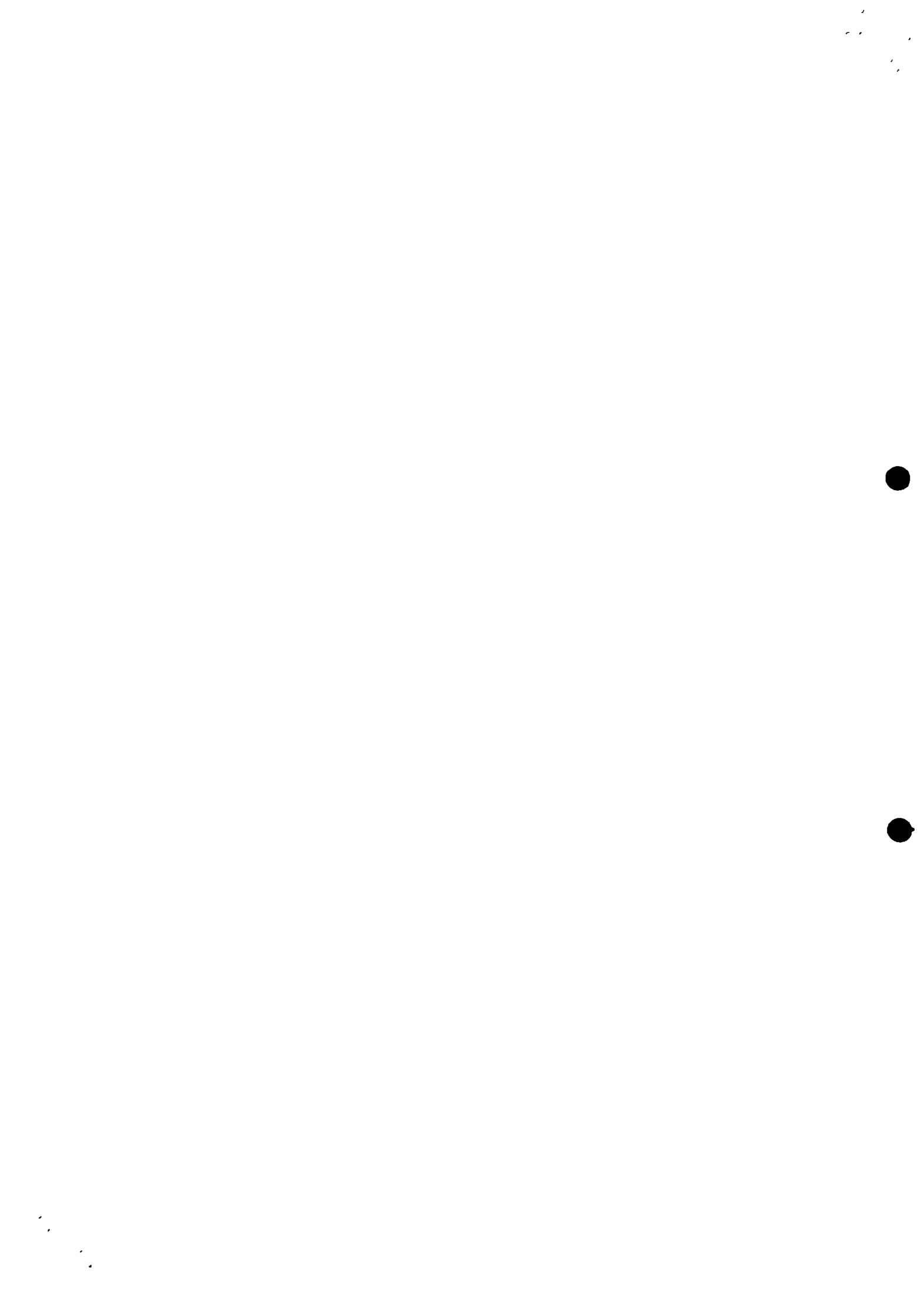



and manpower is required for the construction and operation of the filters. In addition it is planned to continue with the construction of the abandoned SSF boxes in Iringa and to install a HRF in the first of the 3 boxes.

For the information exchange and the support of HRF and SSF implementation two more Seminars are scheduled to take place in Tanzania. These workshops will act as catalysts in the development of rural water treatment practice in Tanzania.

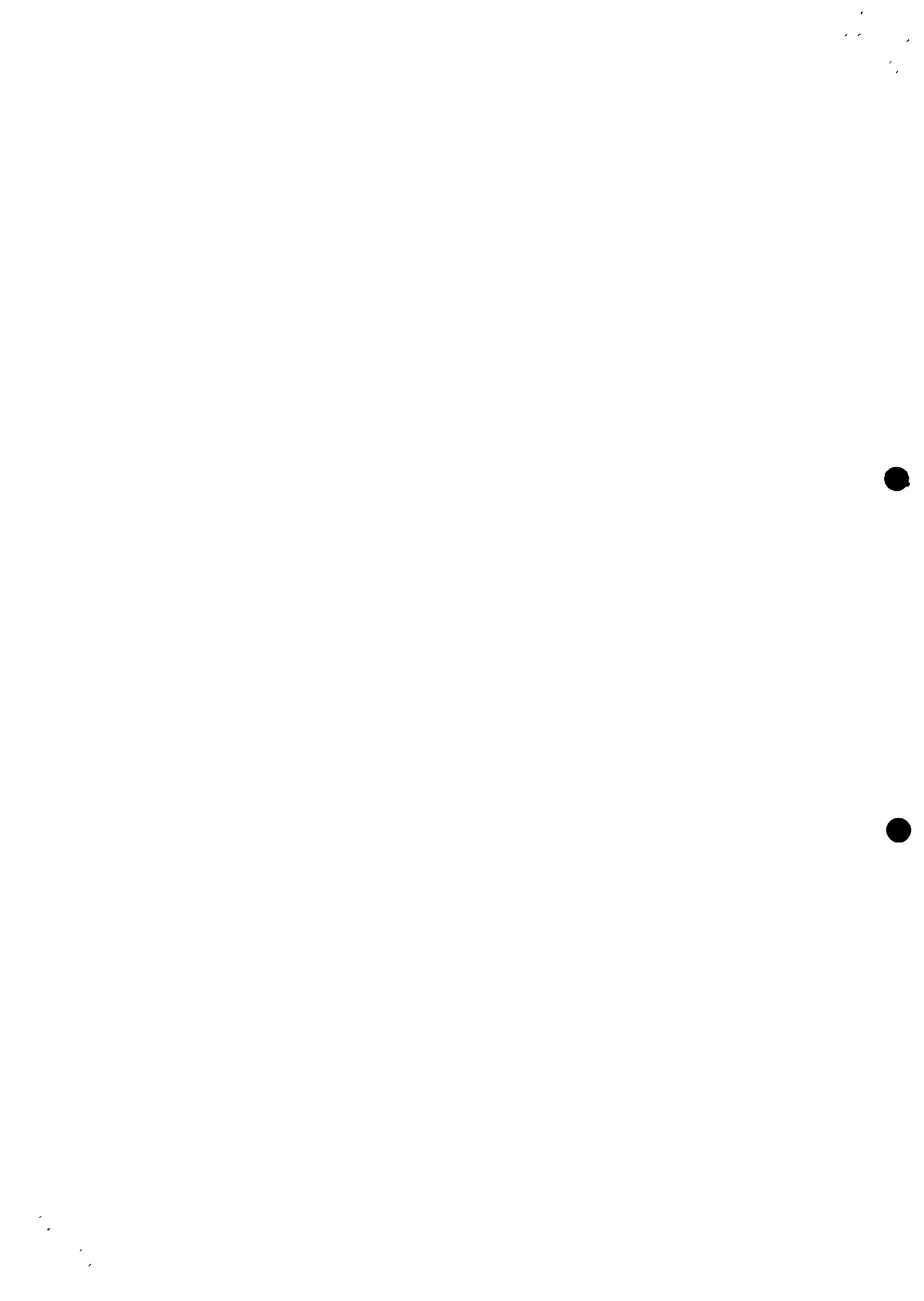

## References

1. Slow Sand Filter Research Programme, Report 1, University DSM, 15.2.1980.
2. Slow Sand Filter Research Project, Report 2, University DSM, 31.7.1980.
3. Horizontal Roughing Filter in Pretreatment of Slow Sand Filters, Riti M.M., Master Thesis 1981, Tampere University of Technology / Finland.
4. A study of upward flow pilot plant filters, Cheserem E.K.A., Master Thesis 1980, University of Nairobi / Kenya.
5. Rural Water Quality Programme in Tanzania, Final Report 1978, Broconsults AB, S-18363 Taby / Sweden.
6. Slow Sand Filtration, Huisman and Wood, 1974, WHO, Geneva / Switzerland.
7. Slow Sand Filtration for Community Water Supply in Developing Countries, A Design and Construction Manual, Technical Paper 11, 1978, IRC/WHO, Rijswijk / The Netherlands.
8. Horizontal-flow coarse-Material Prefiltration, Thanh N.C. and Ouano E.A.R., 1977, AIT, Bangkok / Thailand.
9. Uebersicht über den Stand der künstlichen Grundwasseranreicherung in der Schweiz. Optimaler Einsatz von Kiesvorfiltern, Trüeb, E., 1979, Dortmund / Germany.
10. Horizontaldurchflossene Kiesfilter zum Vorreinigen von Oberflächenwasser besonders in Entwicklungsländern, Trüeb E., 3R, Heft 1/2 1982.

## Contact Addresses

- IRCWD / EAWAG  
Mr. M. Wegelin  
Ueberlandstrasse 133, CH-8600 Dübendorf / Switzerland
- University of Dar es Salaam  
Mr. S. Mbwette  
Faculty of Engineering, P.O.Box 35131, Dar es Salaam / Tanzania

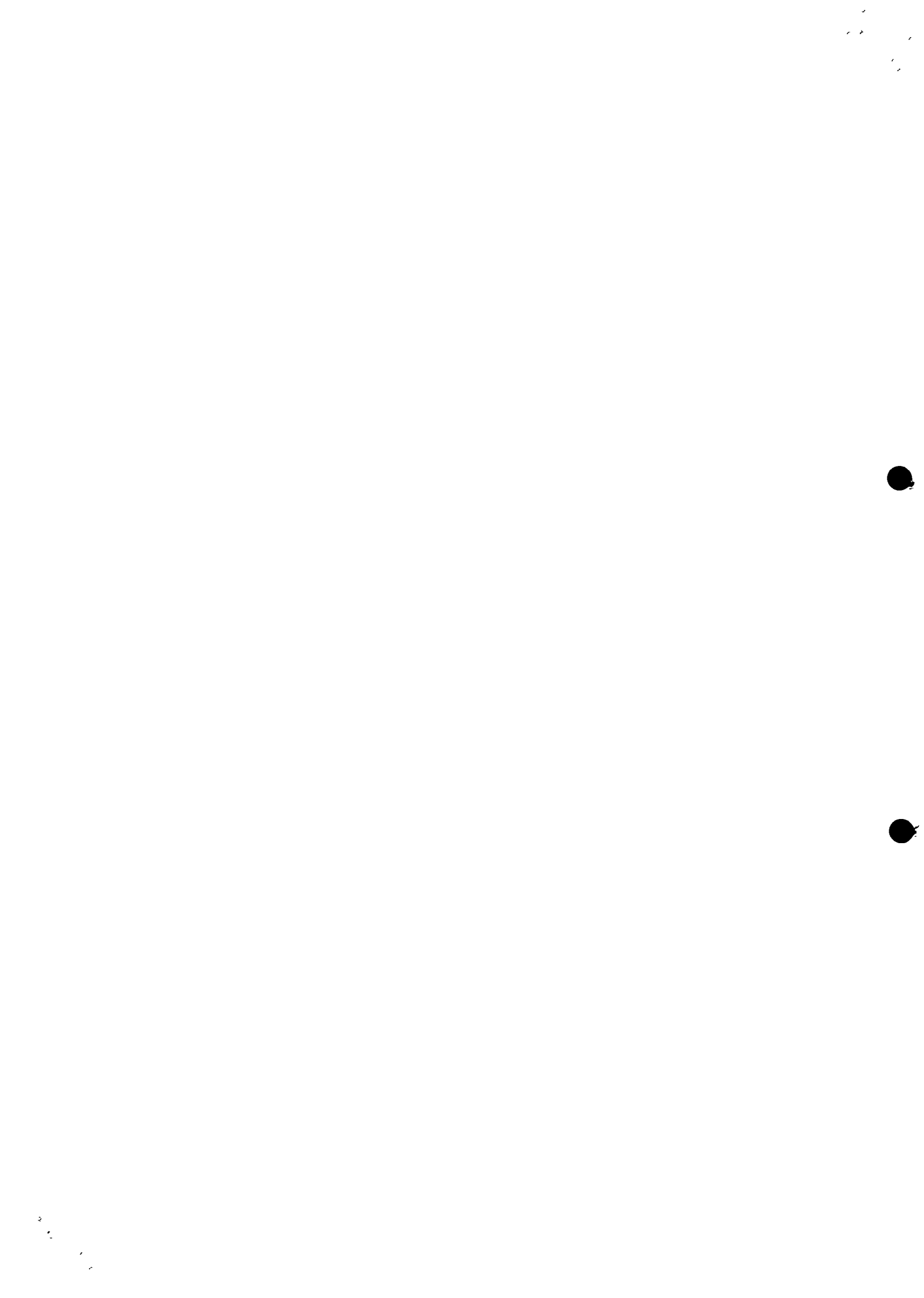

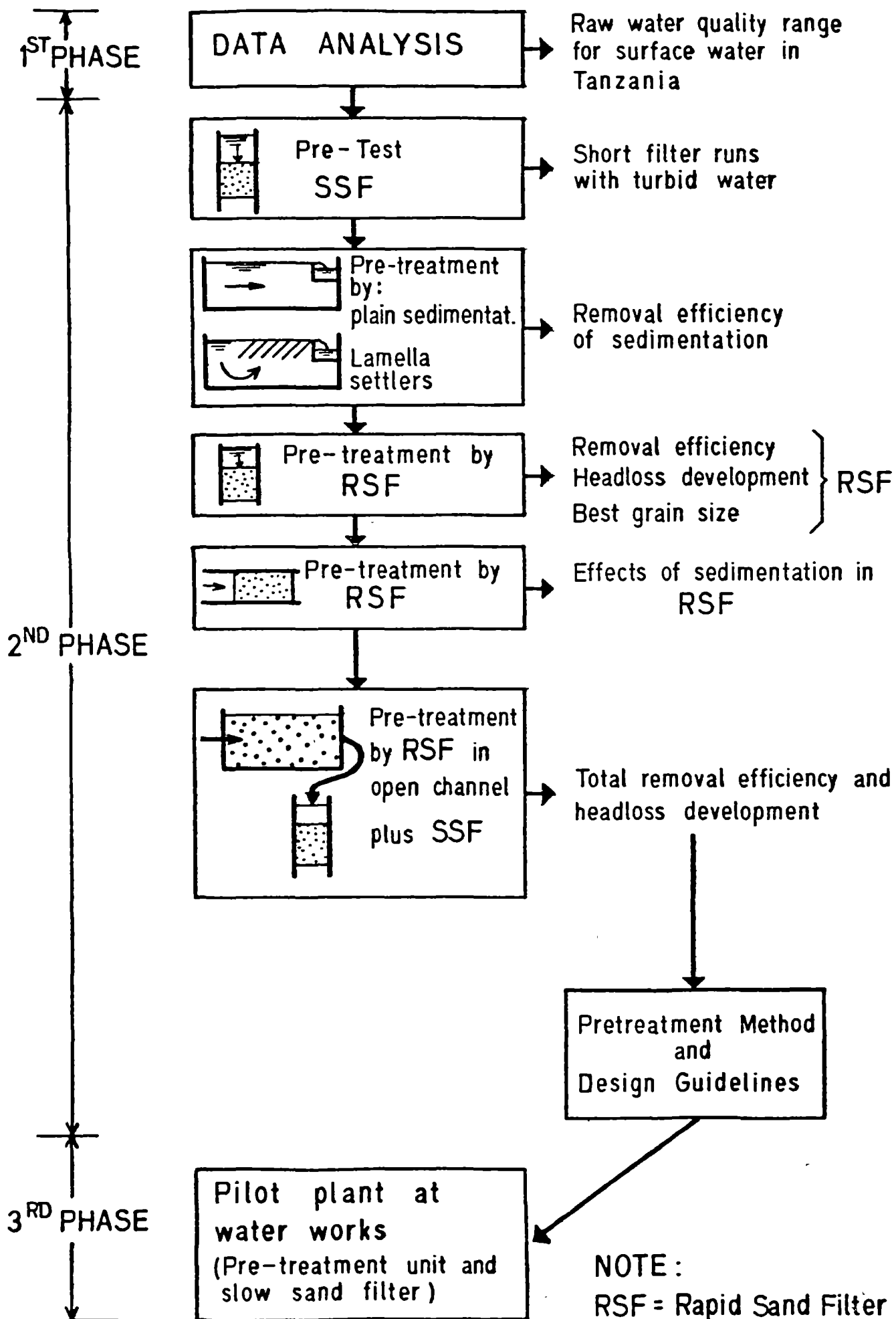

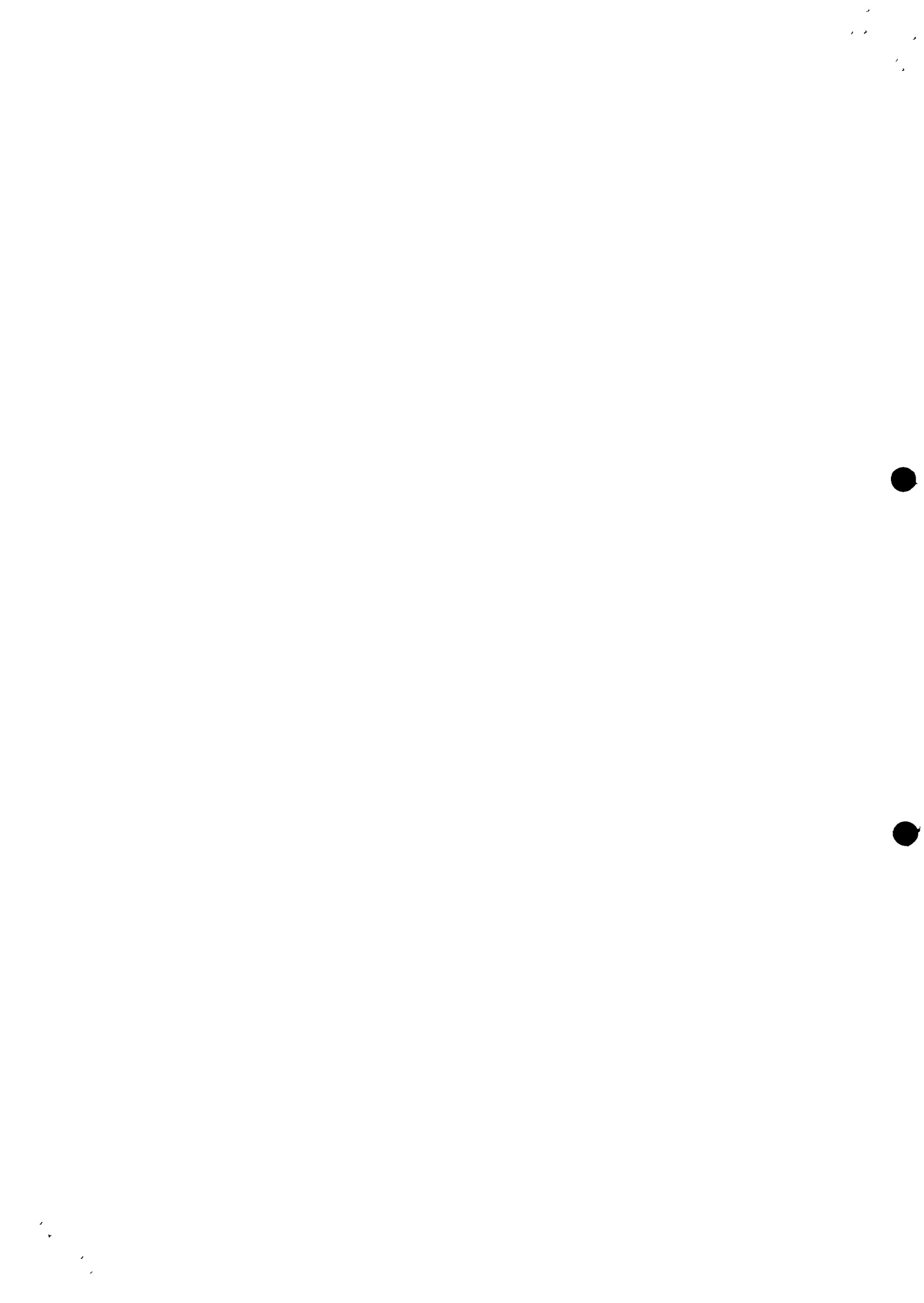

# GENERAL LAY-OUT OF FIELD TESTS IN HANDENI AND WANGING'OMBE

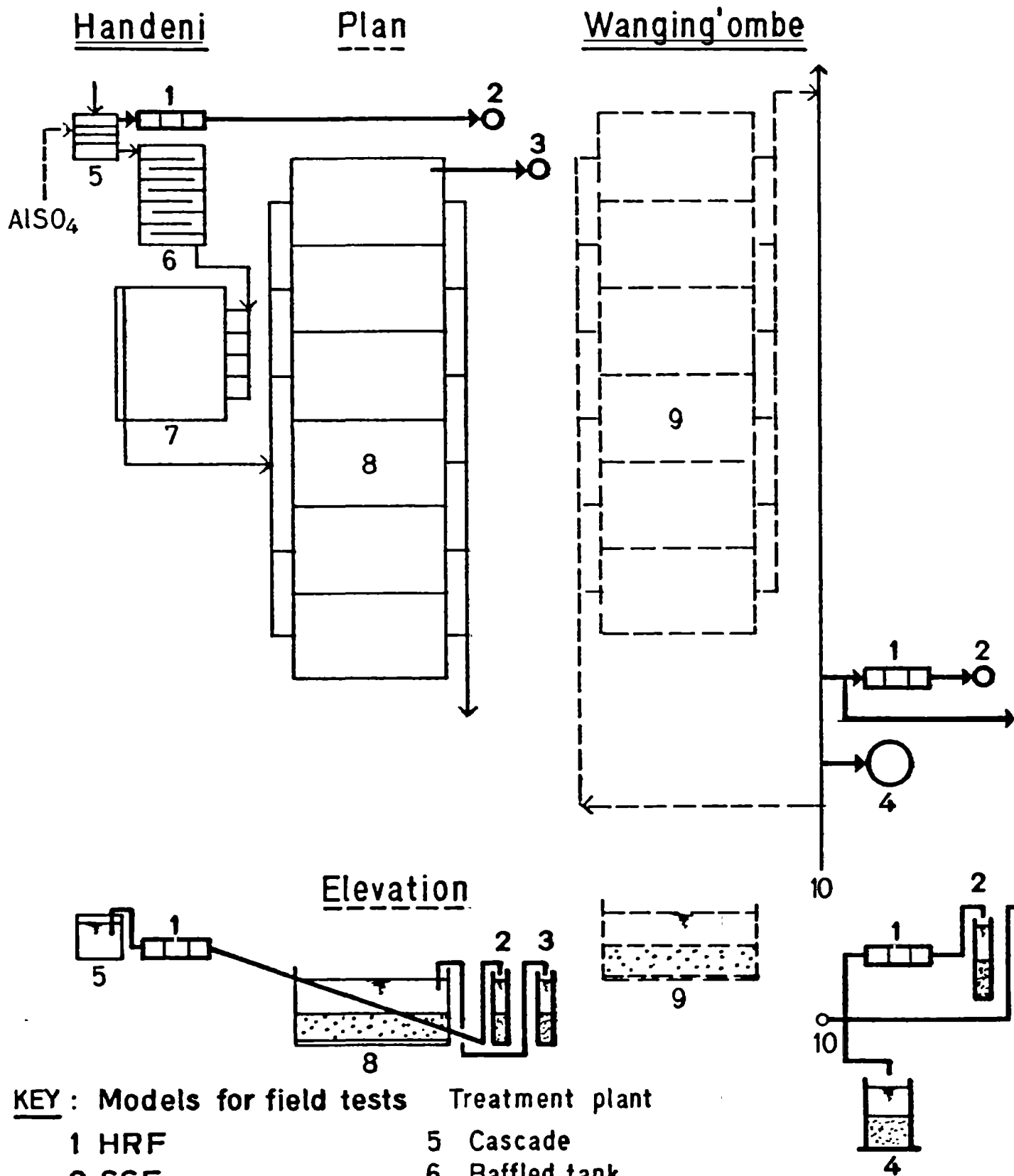

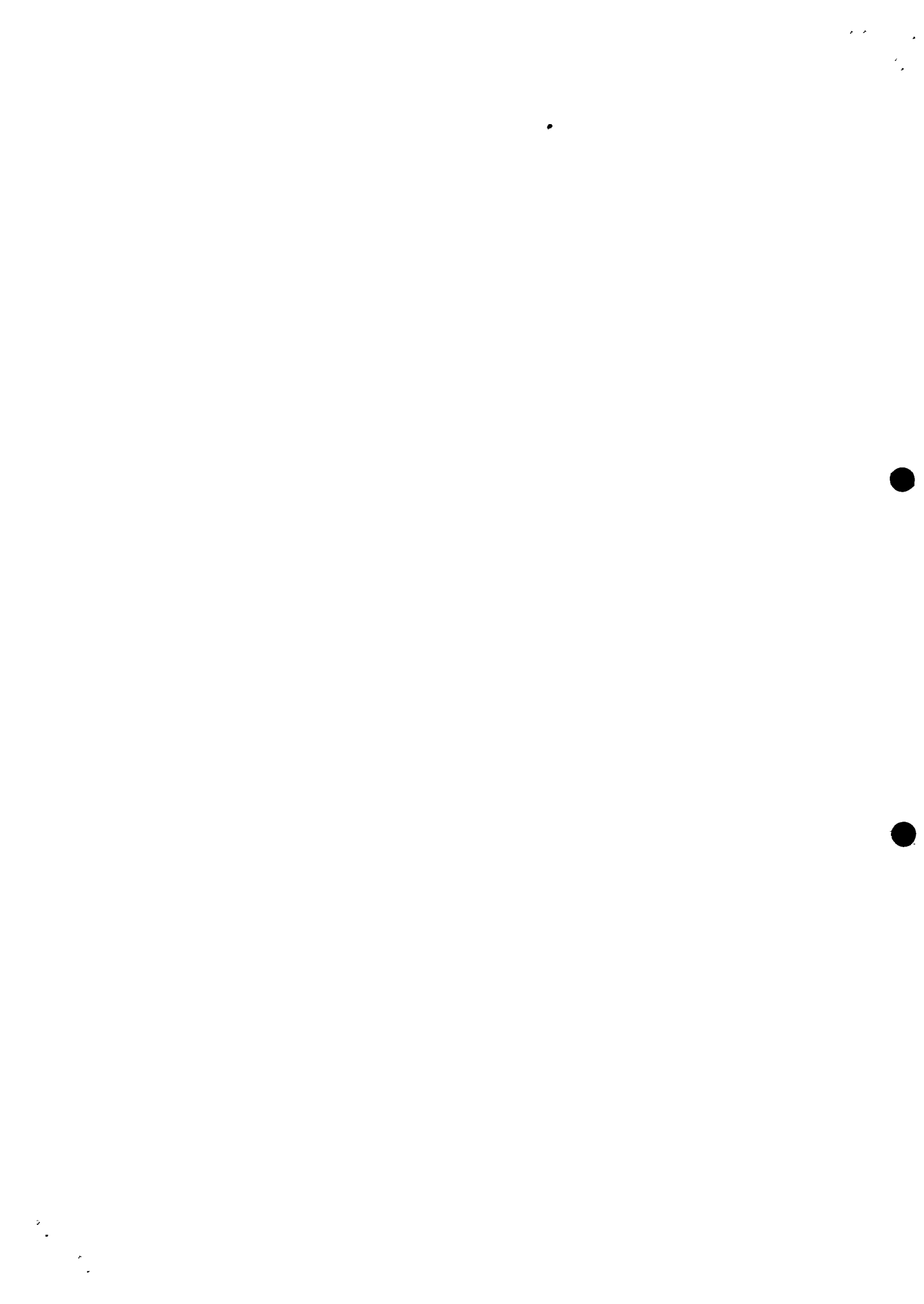



# DETAILS OF THE HORIZONTAL ROUGHING FILTER MODEL FOR HANDENI AND WANGING' OMBE

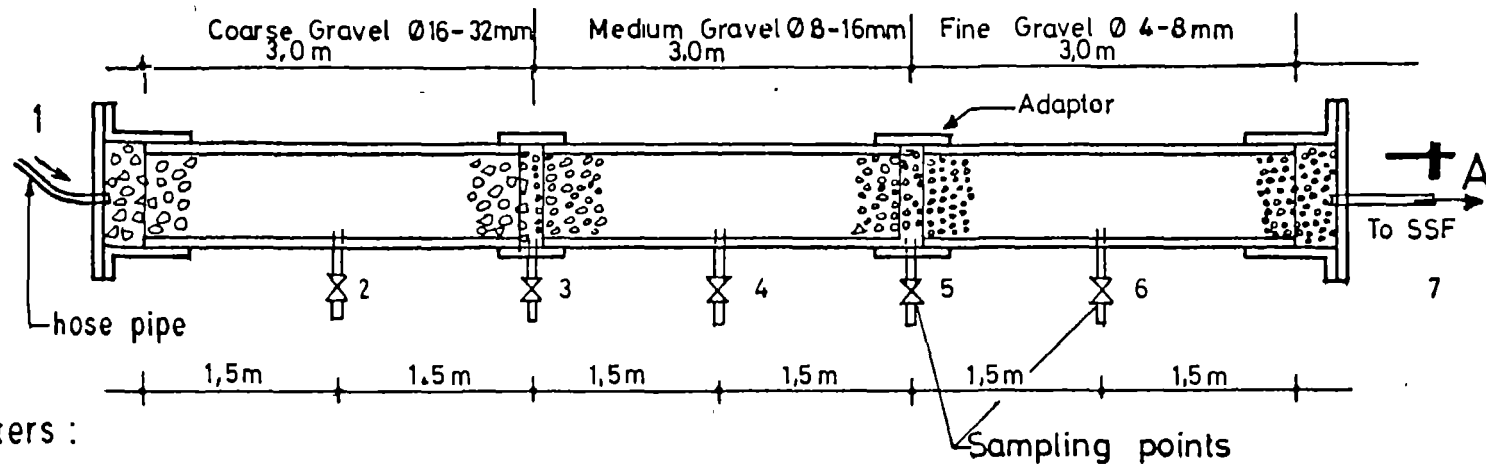

Pipe Diameters :

Ø 250 mm Handeni

Ø 200 mm Wanging' ombe

PLAN VIEW

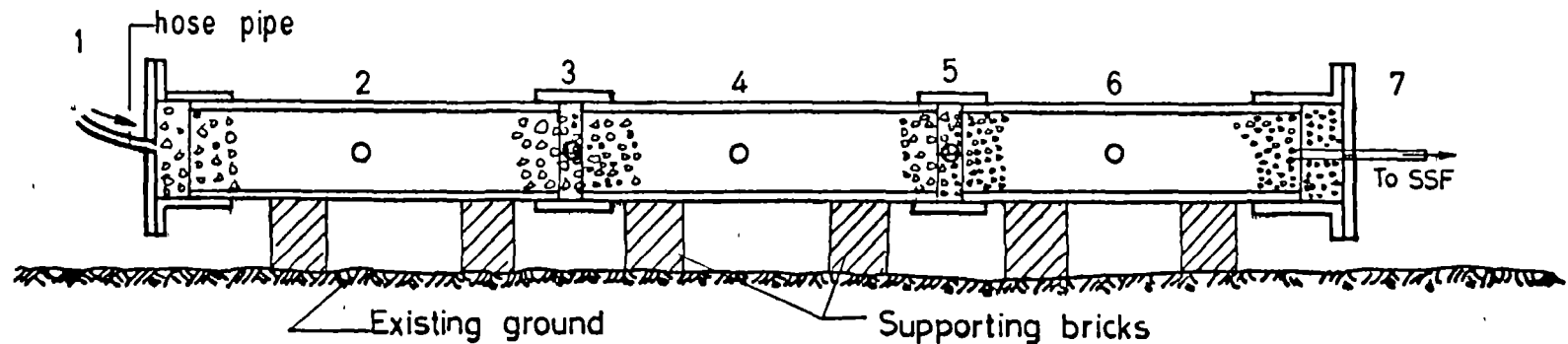

SEC A-A

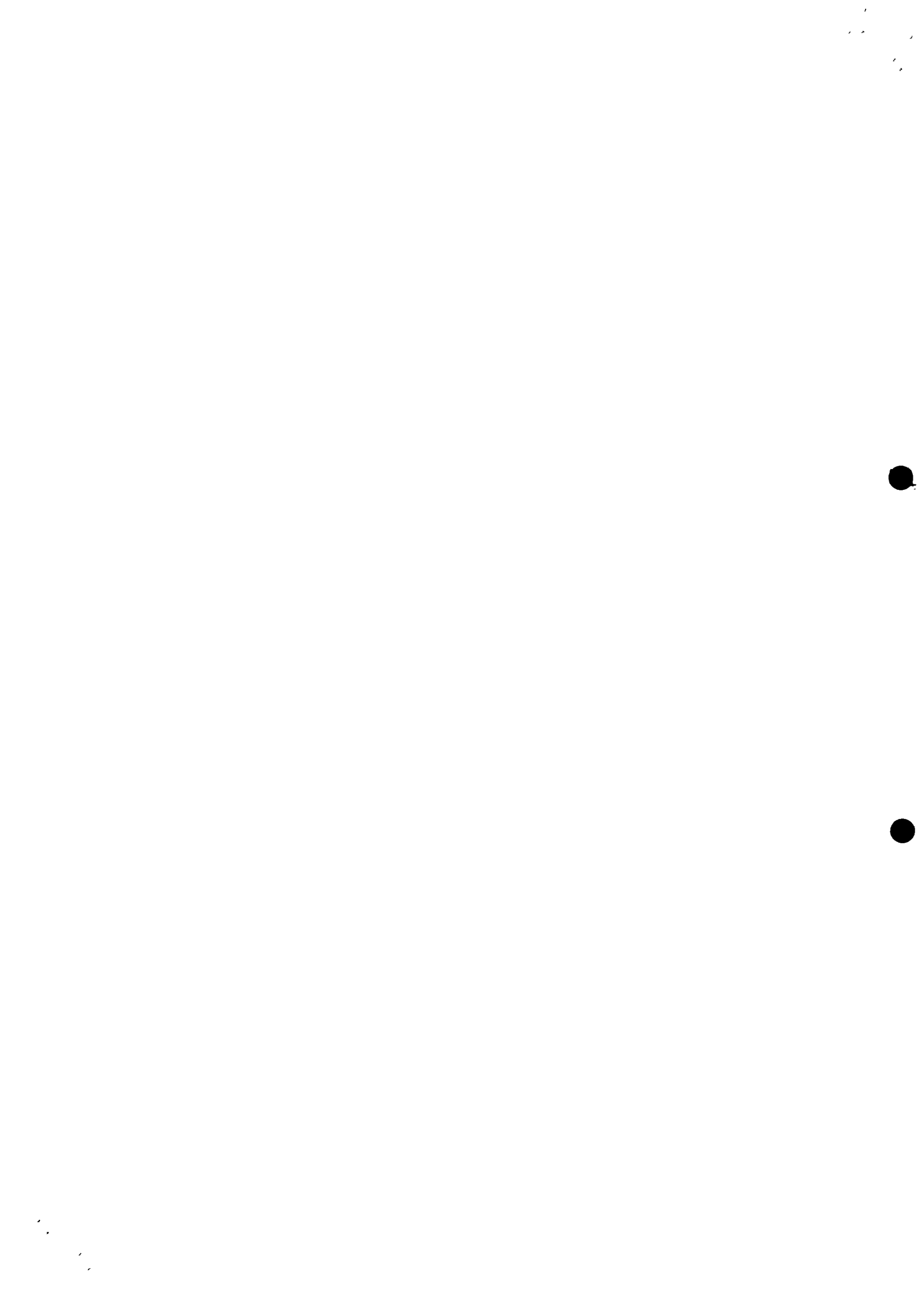

# CROSS SECTION THROUGH SLOW SAND FILTER MODEL FOR HANDENI AND WANGING'OMBE

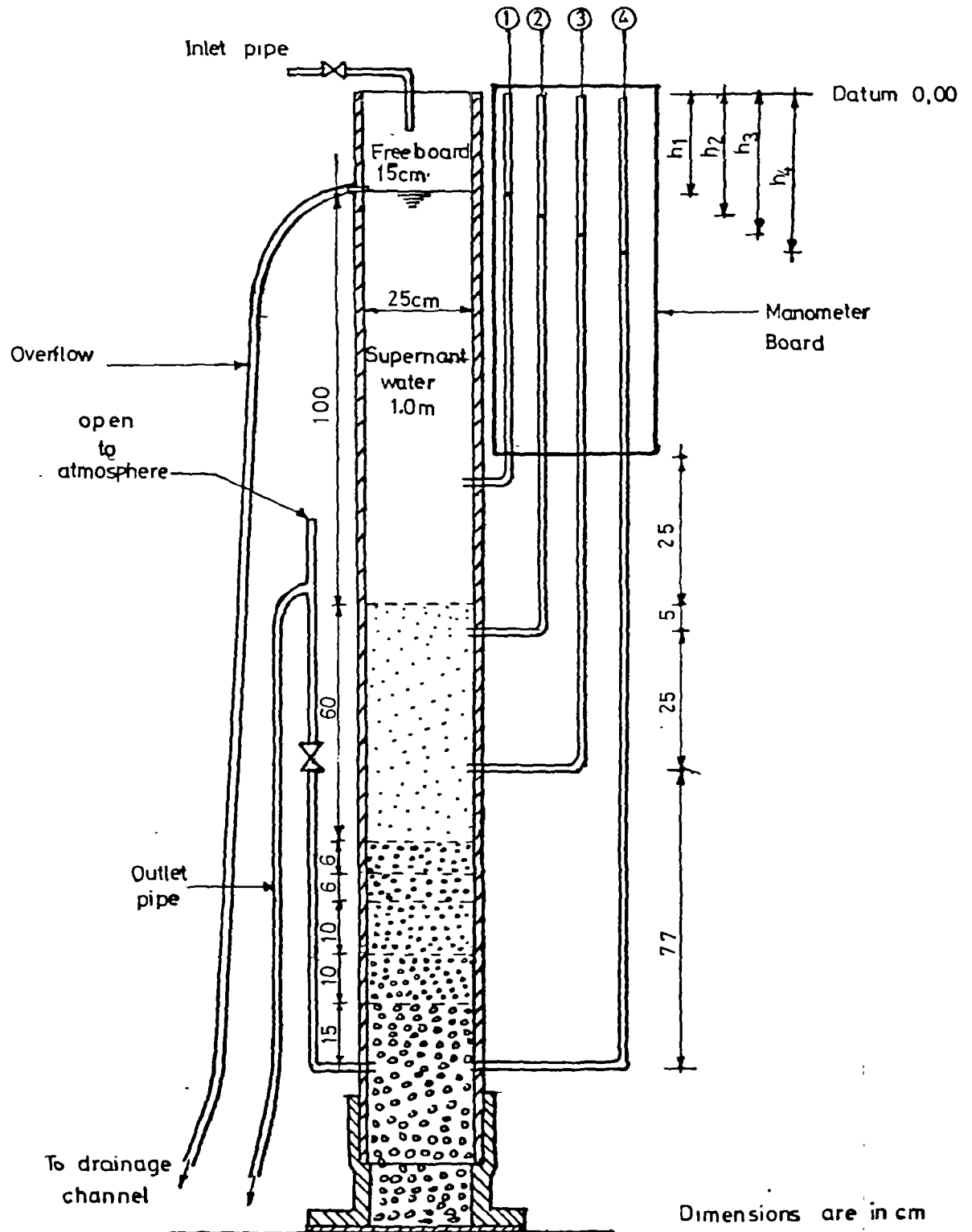

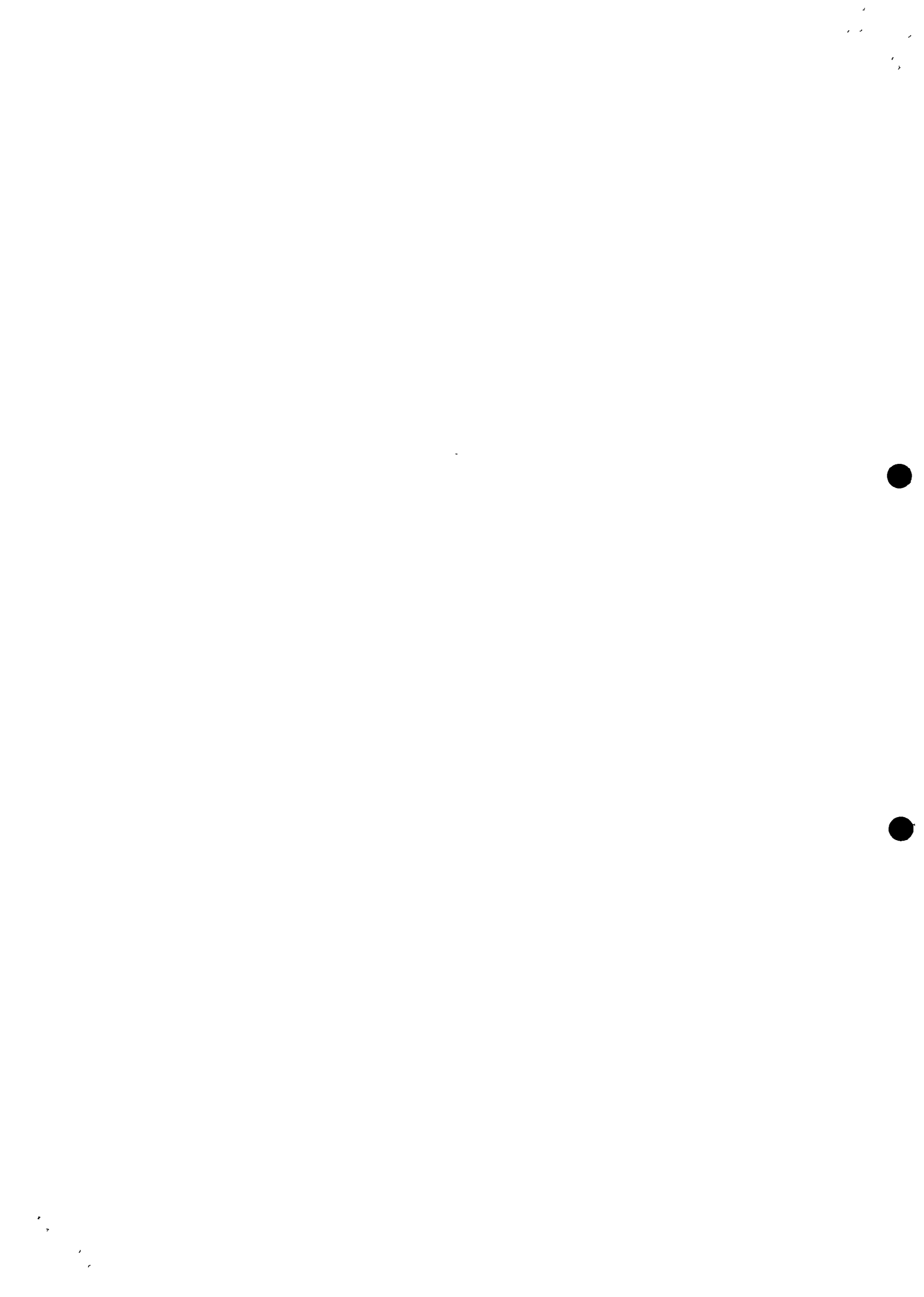

# THE HORIZONTAL ROUGHING FILTER OF THE PILOT PLANT IRINGA

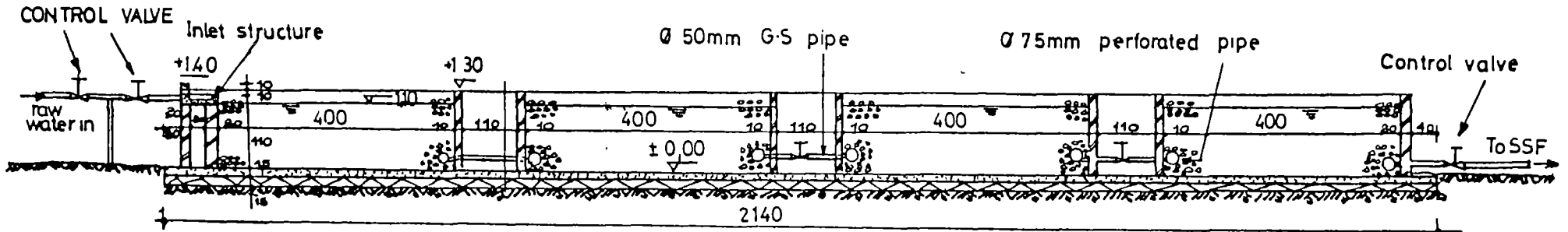

**SECTION P-P**

NOTE :

Provide cement - sand mortar (1:3) of nominal thickness 2cm on all surfaces

SCALE = 1:100

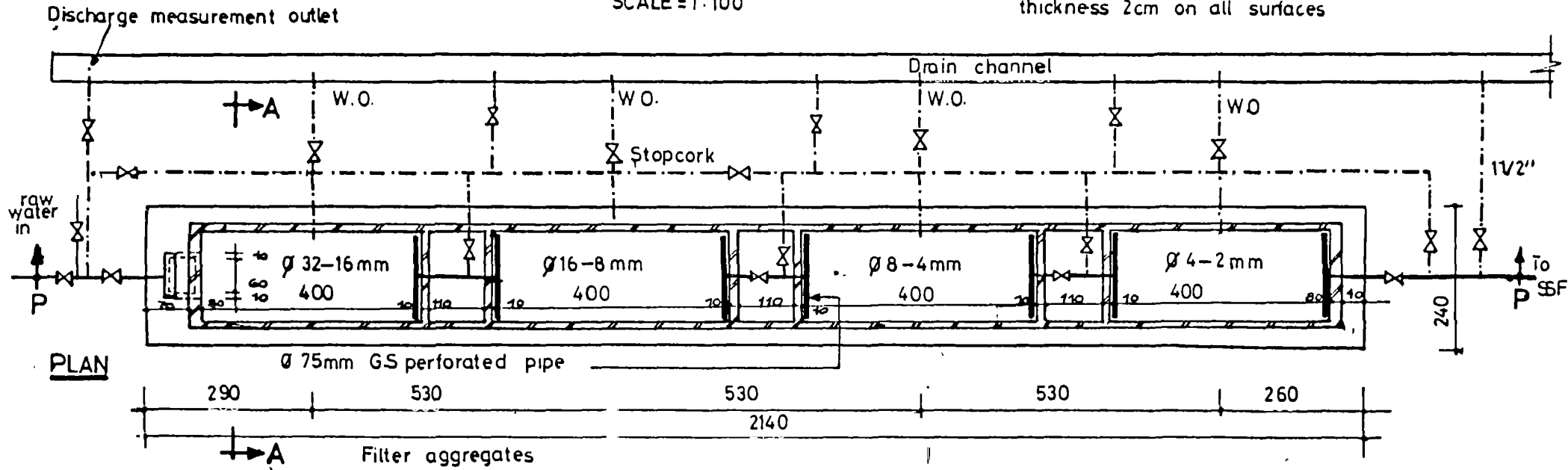

**PLAN**

**SECTION A-A**

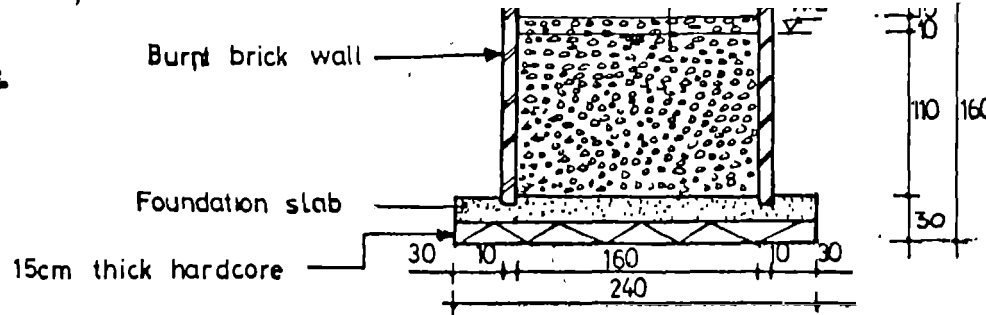

SCALE: 1:50

**LEGEND:**

- = 1:3:6 Concrete mix
- =  $\varnothing$  25mm G-S pipe
- =  $\varnothing$  50mm G-S pipe
- =  $\varnothing$  75mm G-S perforated pipe

W.O = Washout pipe

SSF = Slow sand filter

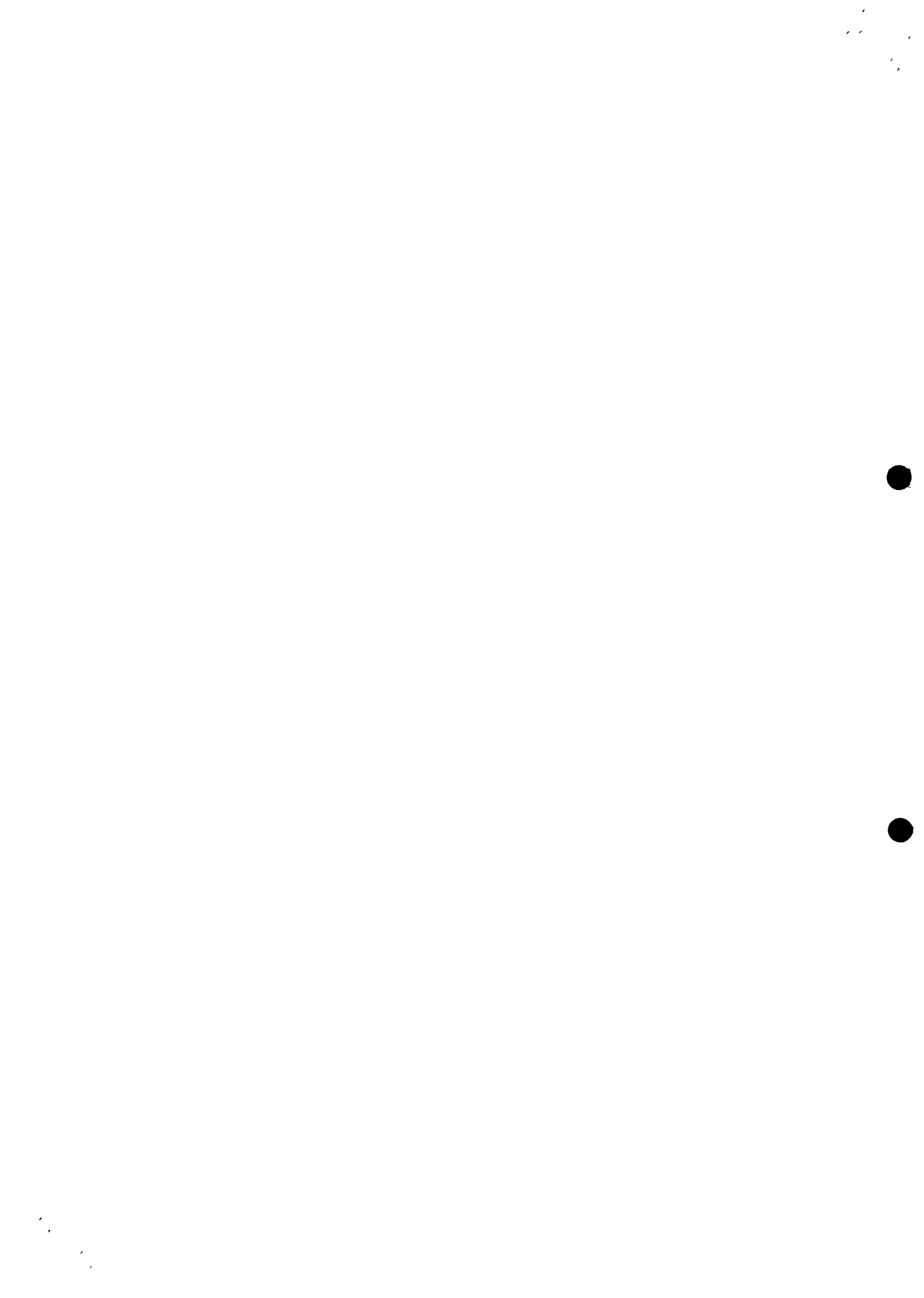

# THE SLOW SAND FILTER OF THE PILOT PLANT IRINGA

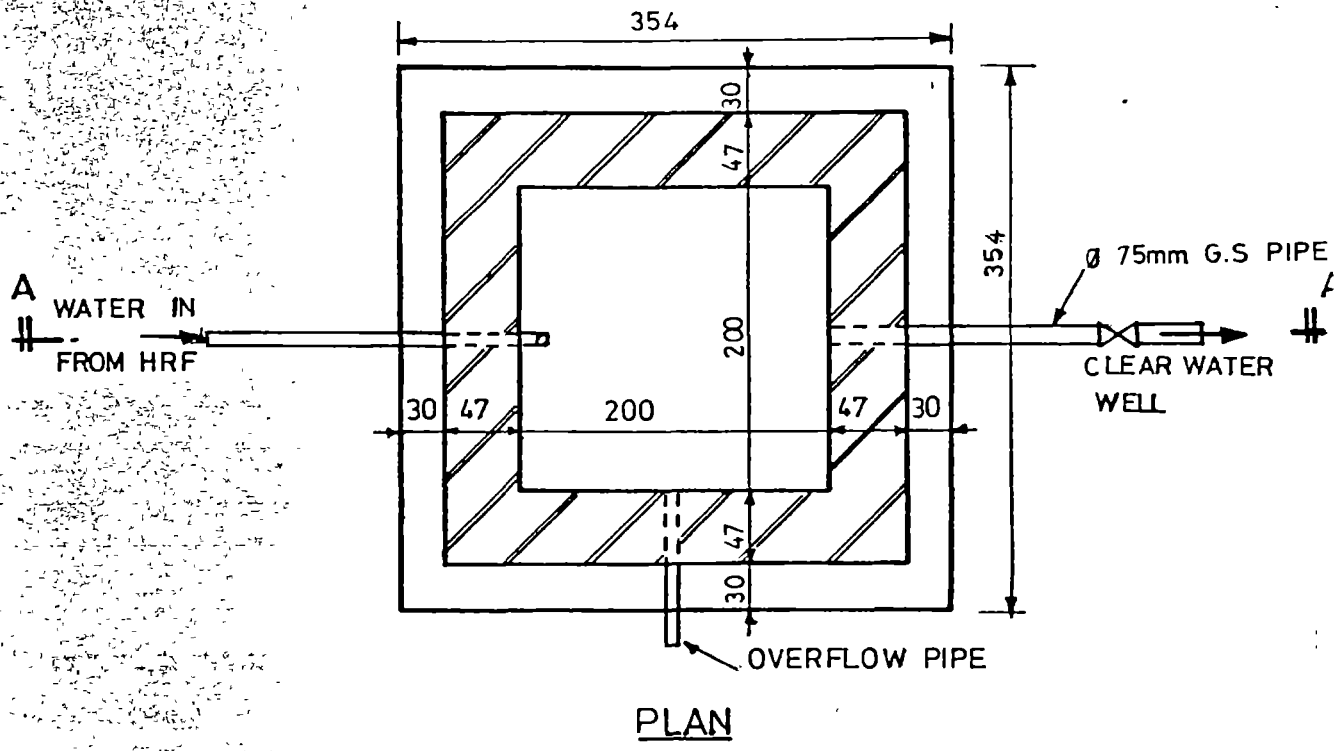
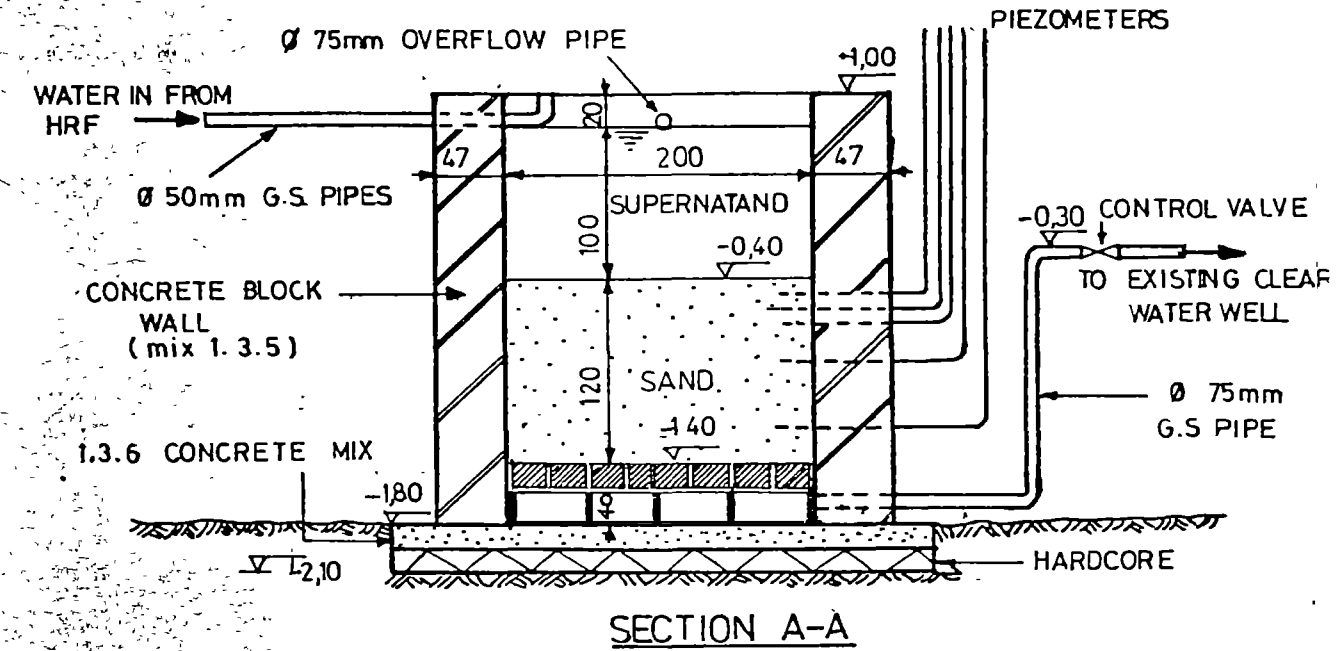

**NOTE:**

1. PROVIDE CEMENT+ SAND MORTAR OF NOMINAL THICKNESS 2cm ON BOTH FACES
2. LEVELS INDICATED ARE IN METRES
3. ALL DIMENSIONS ARE IN CENTIMETRES

SCALE 1:50

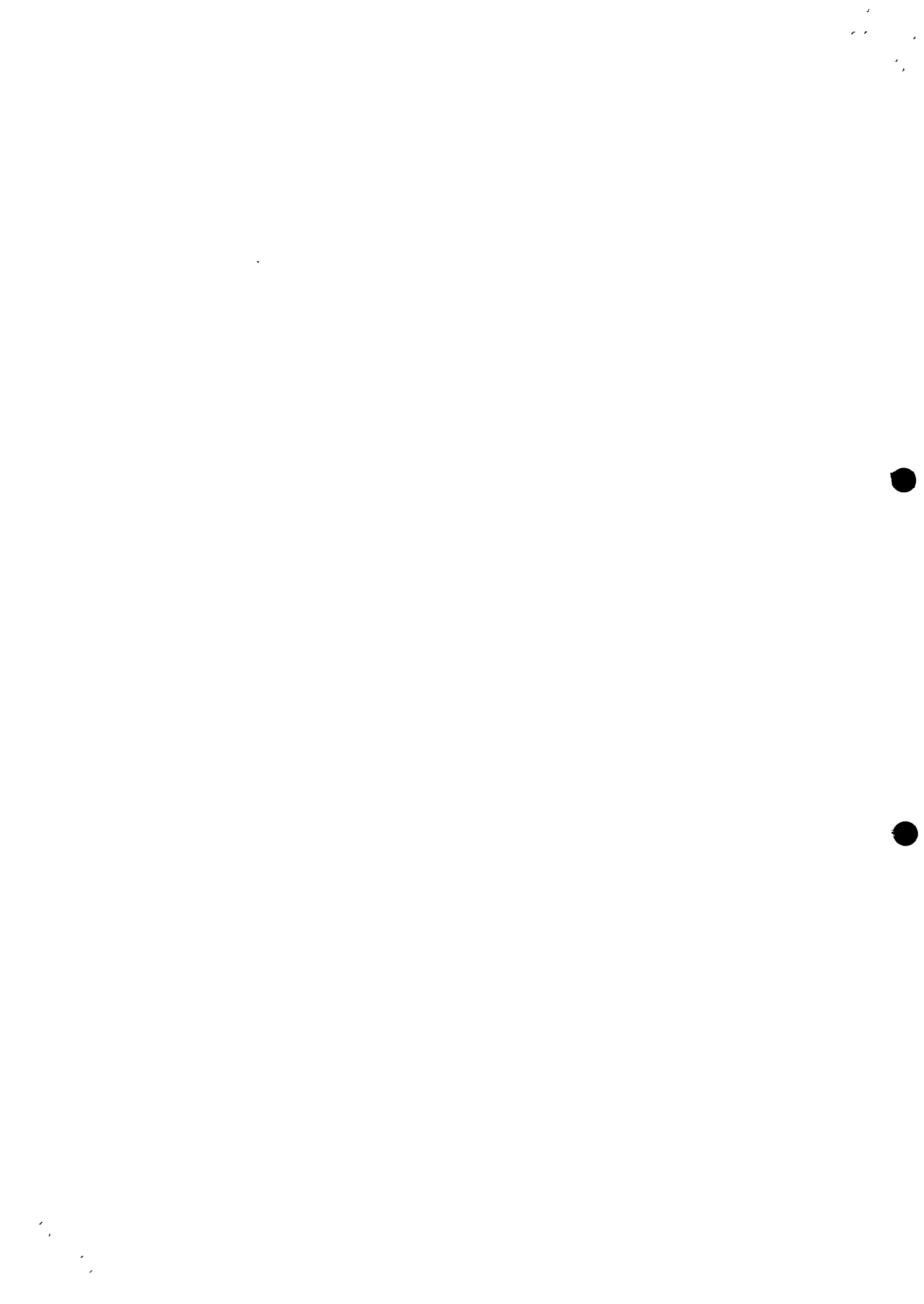



Executed filtration tests in Handeni, Wanging'ombe and Iringa1. Field tests in Handeni

Date	Filtration Rates (m/h)		
	HRF	SSF with pretrmt	SSF without pretrmt
15.-17.12.80	0.50	0.4	0.2
17.-18.12.80	1.00		
18.-19.12.80	1.50		
19.-20.12.80	2.00		
31.12.-			
3.1.81	0.50		
3.- 8.1.81	0.75		
8.-11.1.81	1.00		
11.-12.1.81	0.75		
12.-14.1.81	0.50	0.4	0.2

2. Field tests in Wanging'ombe

Date	Filtration Rates (m/h)			
	HRF	SSF with pretrmt	SSF without pretrmt	big SSF with- out pretrmt
8.-17.2.81	0.5	0.3	0.3	
18.-19.2.81	1.0			
19.-20.2.81	2.0			
20.-22.2.81	0.5			
22.-23.2.81	1.0/0.5/0.5			
23.-24.2.81	1.0/1.0/0.5			
24.-26.2.81	2.0/1.0/0.5			
26.2.-				
11.3.81	0.5			
11.-14.3.81	1.0			
14.-16.3.81	1.0/0.5/0.5		0.3	0.2
16.-17.3.81	1.0/1.0/0.5			
17.3.-				
2.4.81	0.5	0.3		
8.6.81				0.2
8.6.-27.6.81	0.5	0.2	0.2	0.2
30.6.- 4.8.81	1.0	0.2	-	0.2

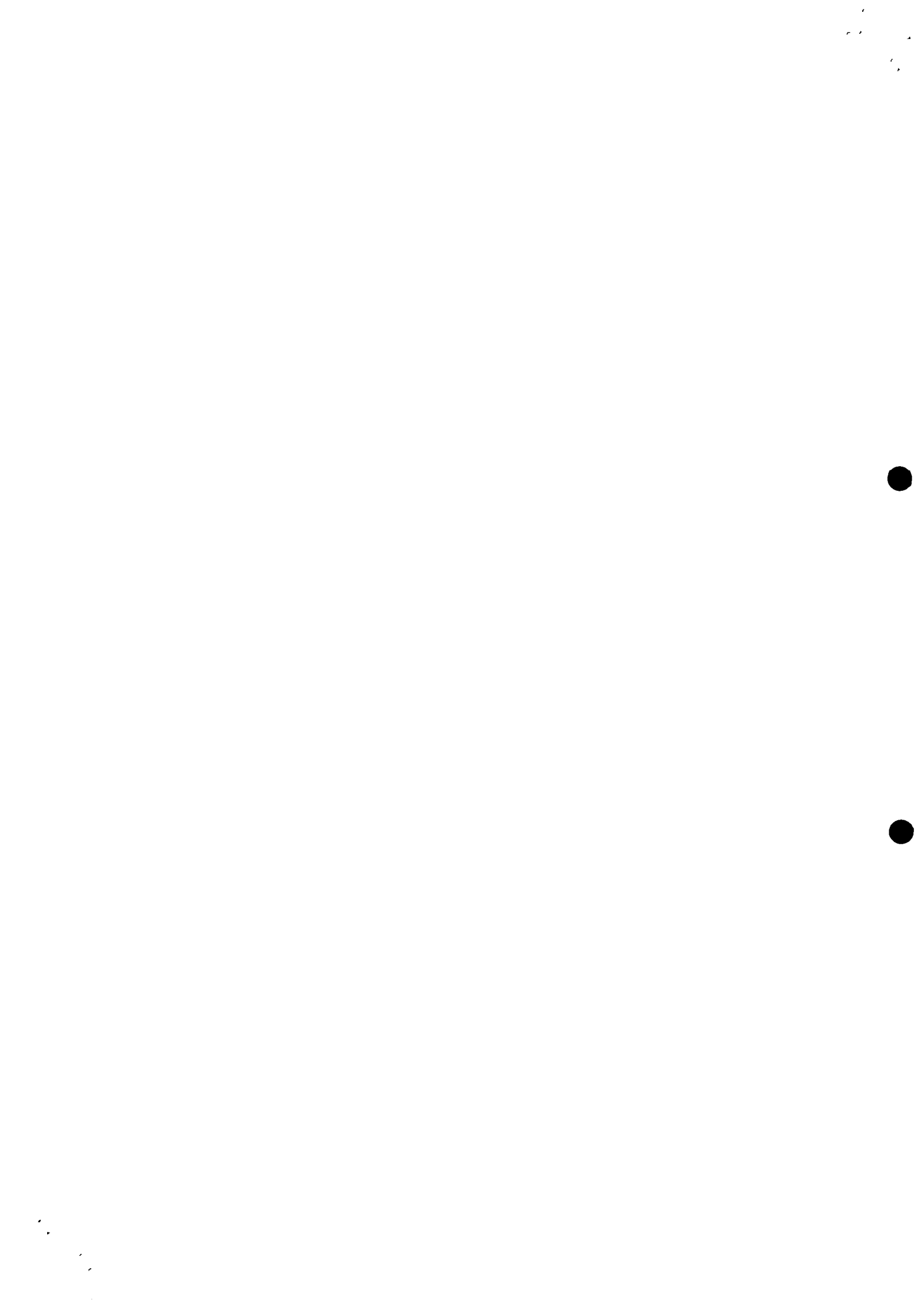

3. Field tests in Iringa

Date	Filtration Rates (m/h)	
	HRF	SSF
11.-13.3.81	2.0	0.2
14.-15.3.81	1.5	
16.-17.3.81	1.0	
18.-20.3.81	0.5	
21.-22.3.81	1.0	
31.3.-		
1.4.81	2.0	
7.-10.4.81	2.0	
11.-17.4.81	1.0	
18.4.-		
5.5.81	0.5	
6.-10.5.81	1.0	
11.-15.5.81	0.5	
16.-22.5.81	2.0/2.0/1.0/1.0	
23.-28.5.81	1.0/1.0/0.5/0.5	
29.-30.5.81	1.0	
1.- 4.6.81	1.0	
5.-13.6.81	2.0	
14.-22.6.81	1.5	
23.-24.6.81	2.0	
25.6.81	3.0	0.2
14.-16.8.81	3.0	0.2
17.-19.8.81	4.0	
20.-24.8.81	5.0	
25.-26.8.81	4.0	
27.-30.8.81	-/2.0/2.0/2.0	
31.8.-		
1.9.81	-/4.0/4.0/4.0	
1.- 2.9.81	-/ - /2.0/2.0	
2.- 3.9.81	-/ - /4.0/4.0	0.2

Note:

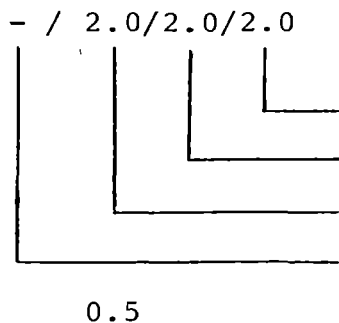

Filtration Rate in:

- 4th compartment
- 3rd compartment
- 2nd compartment
- 1st compartment (by-passed)

Filtration Rate constant throughout HRF

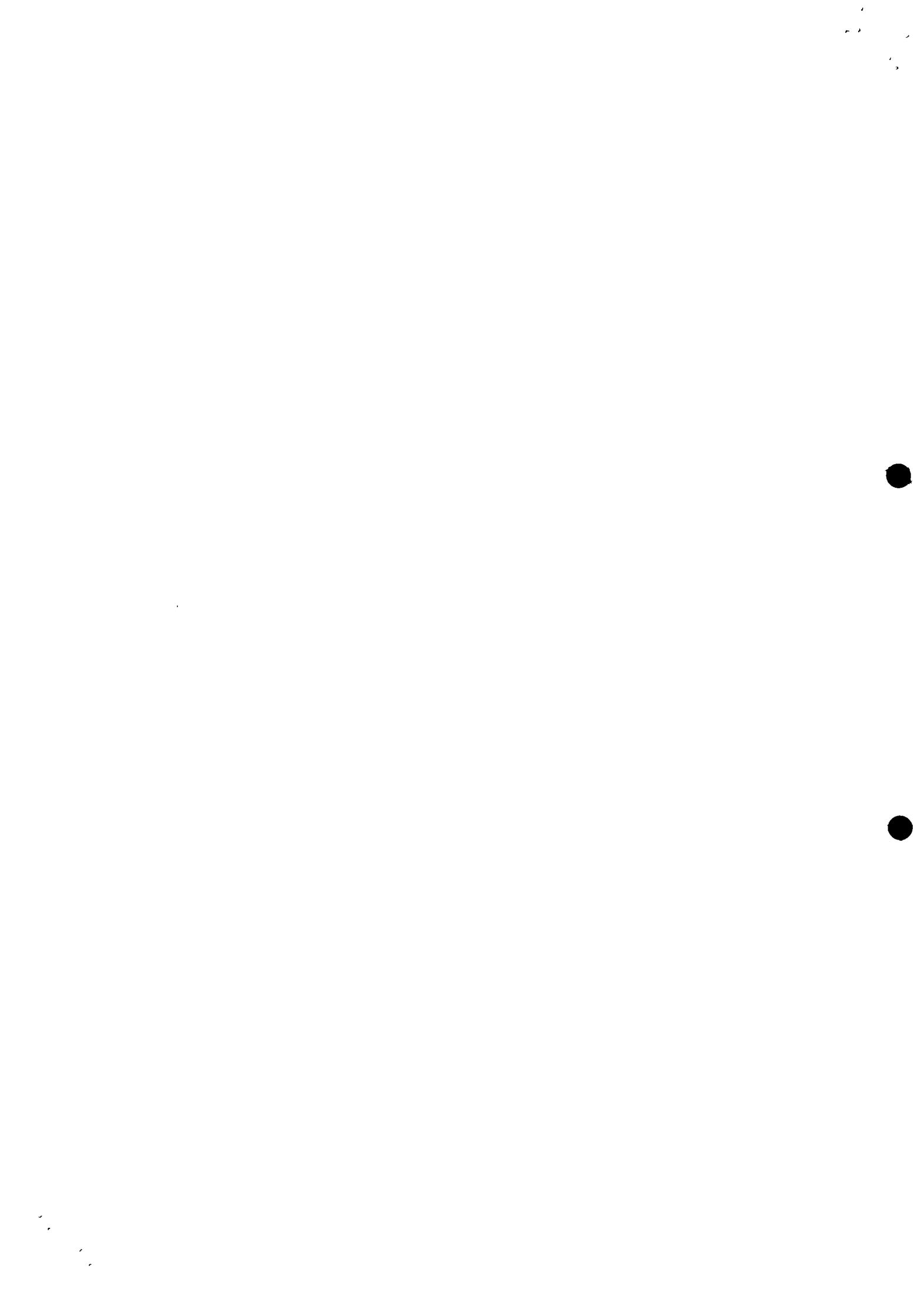

# FILTERABILITY TEST

APPENDIX 8

## Apparatus

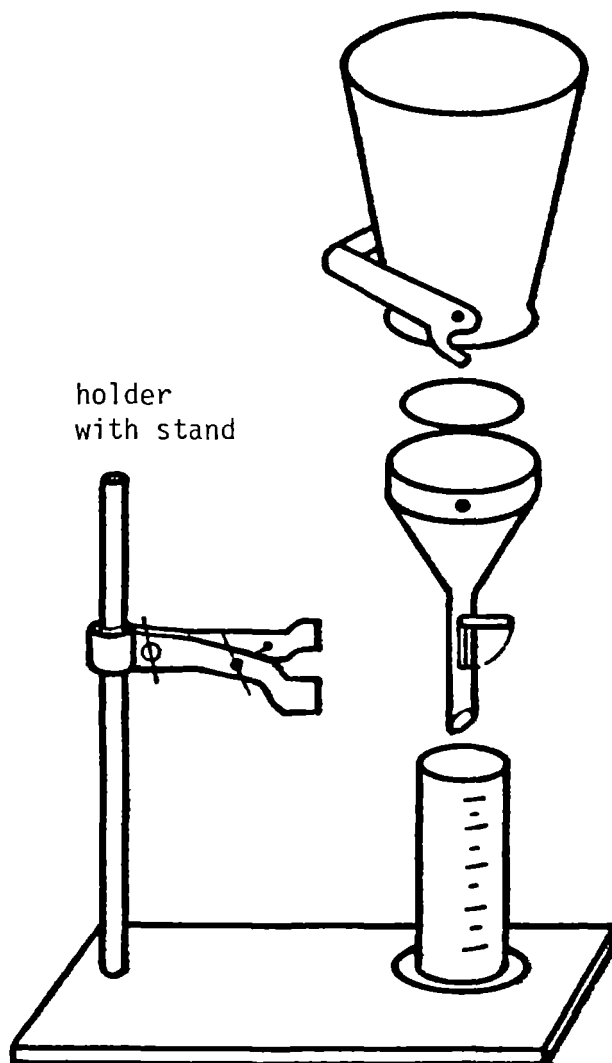

funnel \*  
500 ml

filter paper No. 595  
(Schleicher and Schüll)

filter support \*

valve \*

graduated cylinder  
200 ml

\* supplied e.g. by  
Sartorius, P.O.Box 19  
D-3400 Göttingen, W-Germany  
Ref.No. SM 162 01

### Test Procedure:

- place a filter paper on the filter support and fix the funnel
- put the glass cylinder under the funnel
- close the tap (horizontal position) of the funnel
- pour 500 ml of the water to be tested in the funnel
- open the tap (vertical position) and record the volume of filtered water in ml after 1 Min, 2 Min and 3 Min.

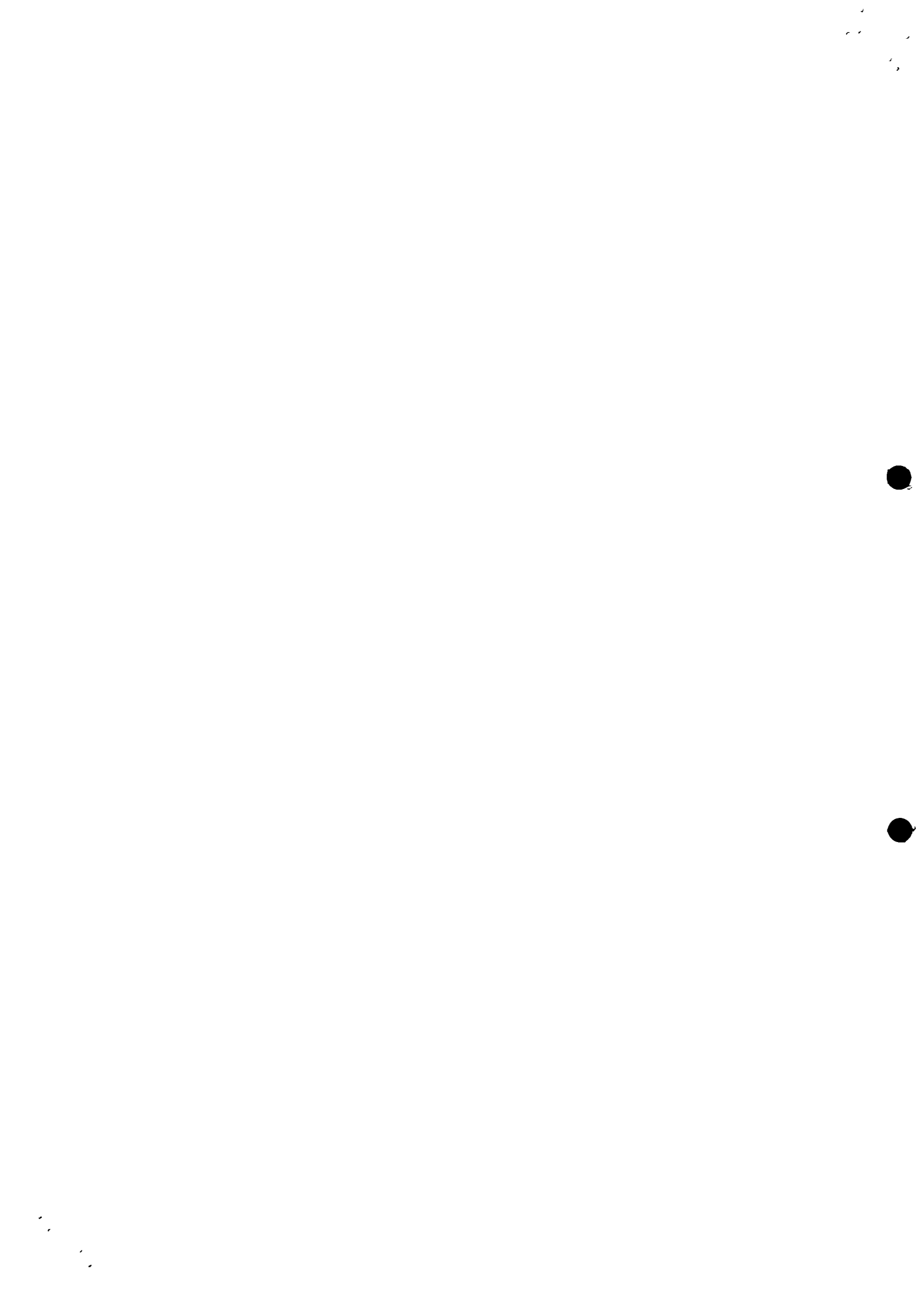

# JACKSON TURBIDITY, LEGIBILITY TEST

APPENDIX 9

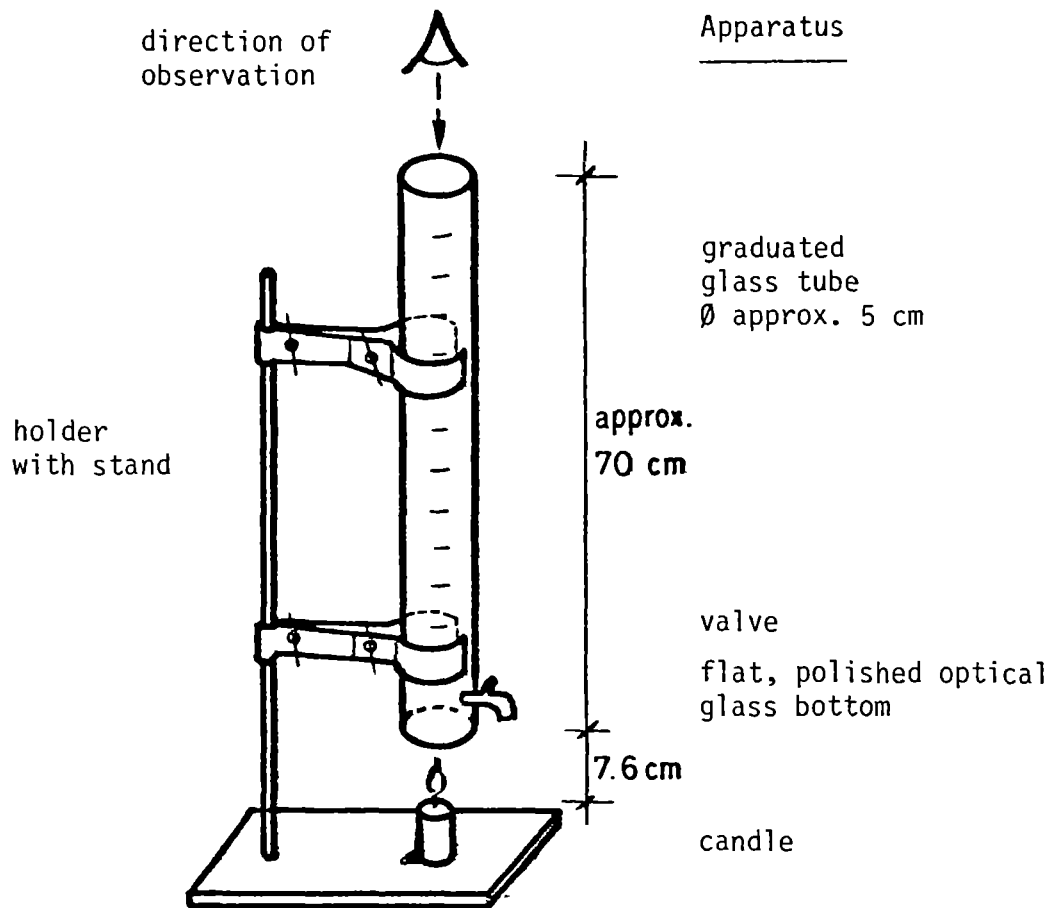

Original size of test letters (Ref. Deutsche Einheitsverfahren)  
for Legibility Test:

**ABCDE**

## Test Procedure

- ignite the candle
  - place the bottom of the tube 7.6 cm above the top of the flame
  - place the bottom of the tube 2 cm above the paper with the test letters
  - fill the tube with water to be tested
  - drain the tube until you can see the flame/the test letters
  - measure the water height and record it in cm.
- } for Jackson Turbidity
- } for Legibility Test

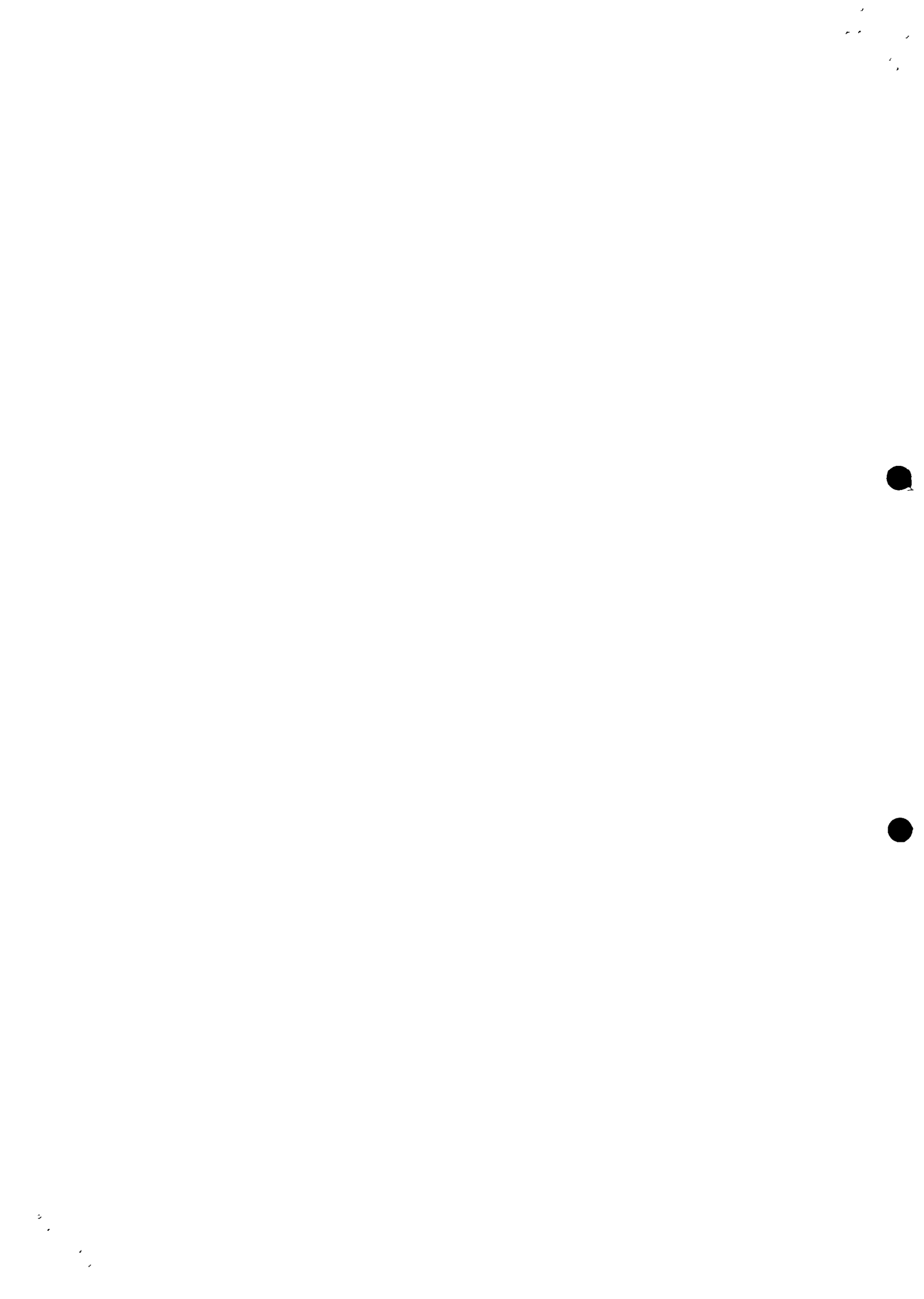



TURBIDITY (NTU)

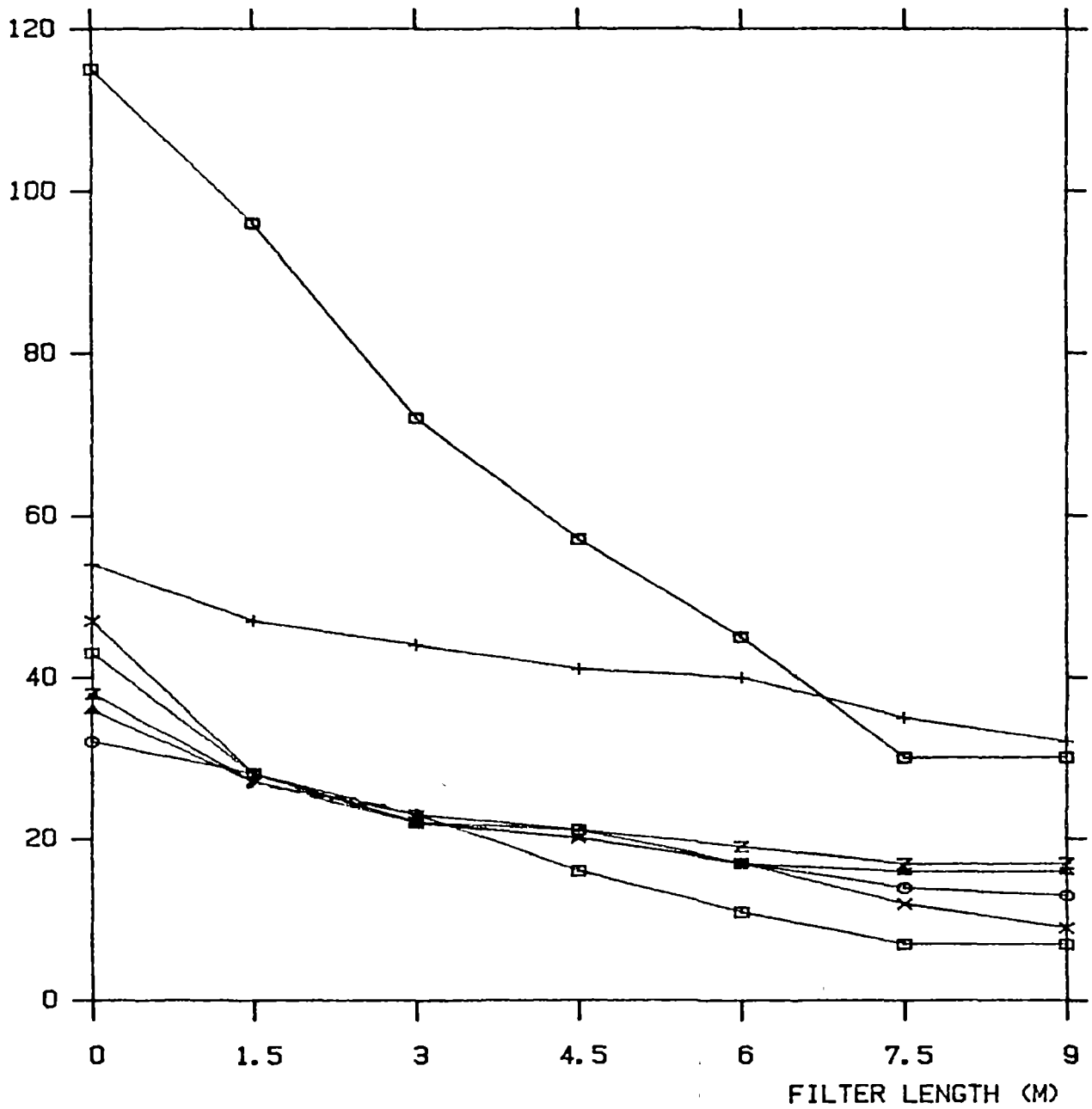

Filtration Rate : □ 0.5 m/hr  
 X 0.75 m/hr  
 ○ 1.0 m/hr  
 z 1.5 m/hr  
 △ 2.0 m/hr  
 + 2.5 m/hr

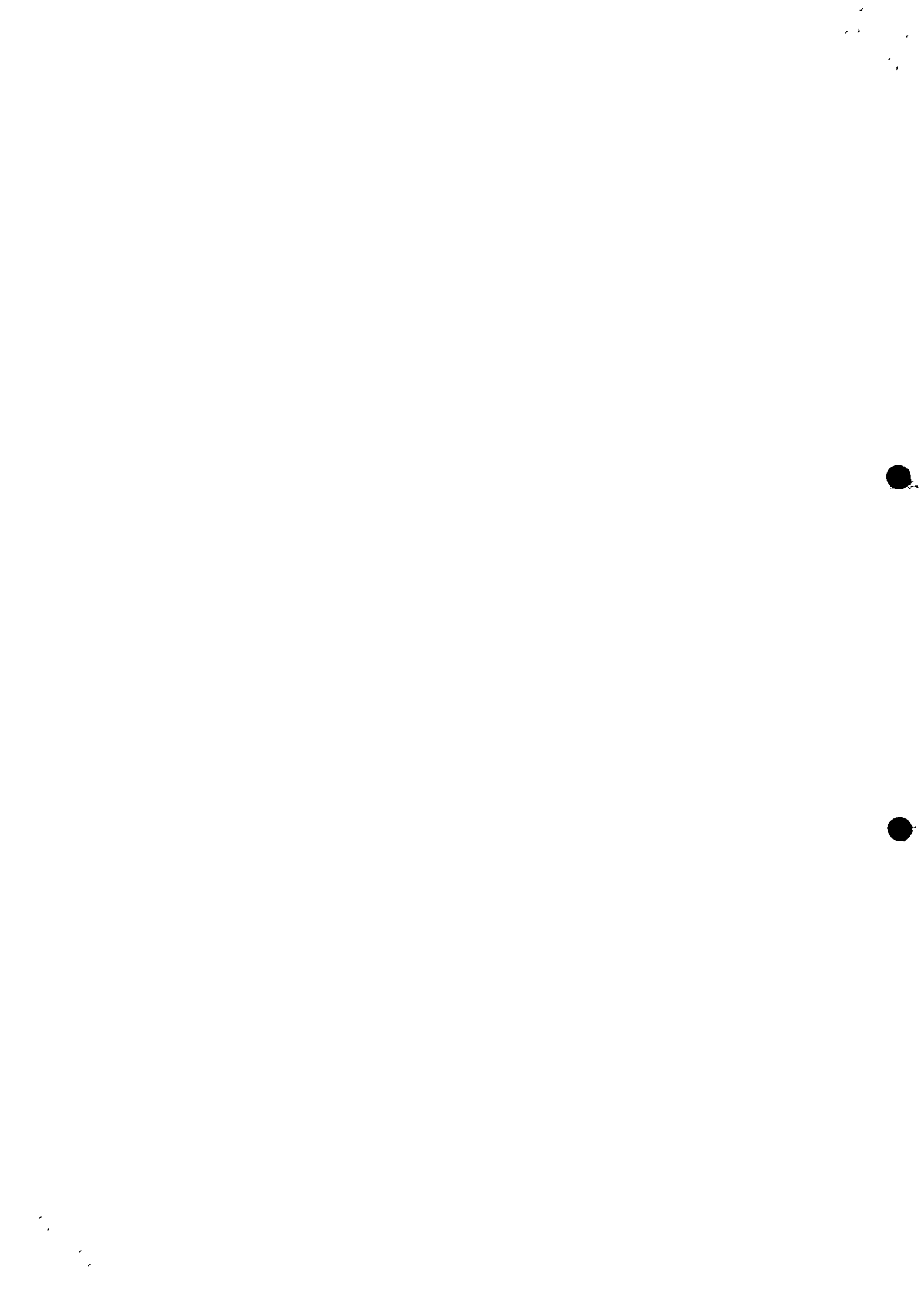

SUSPENDED SOLIDS REDUCTION WITH HRF IN HANDENI

SUSPENDED SOLIDS (MG/L)

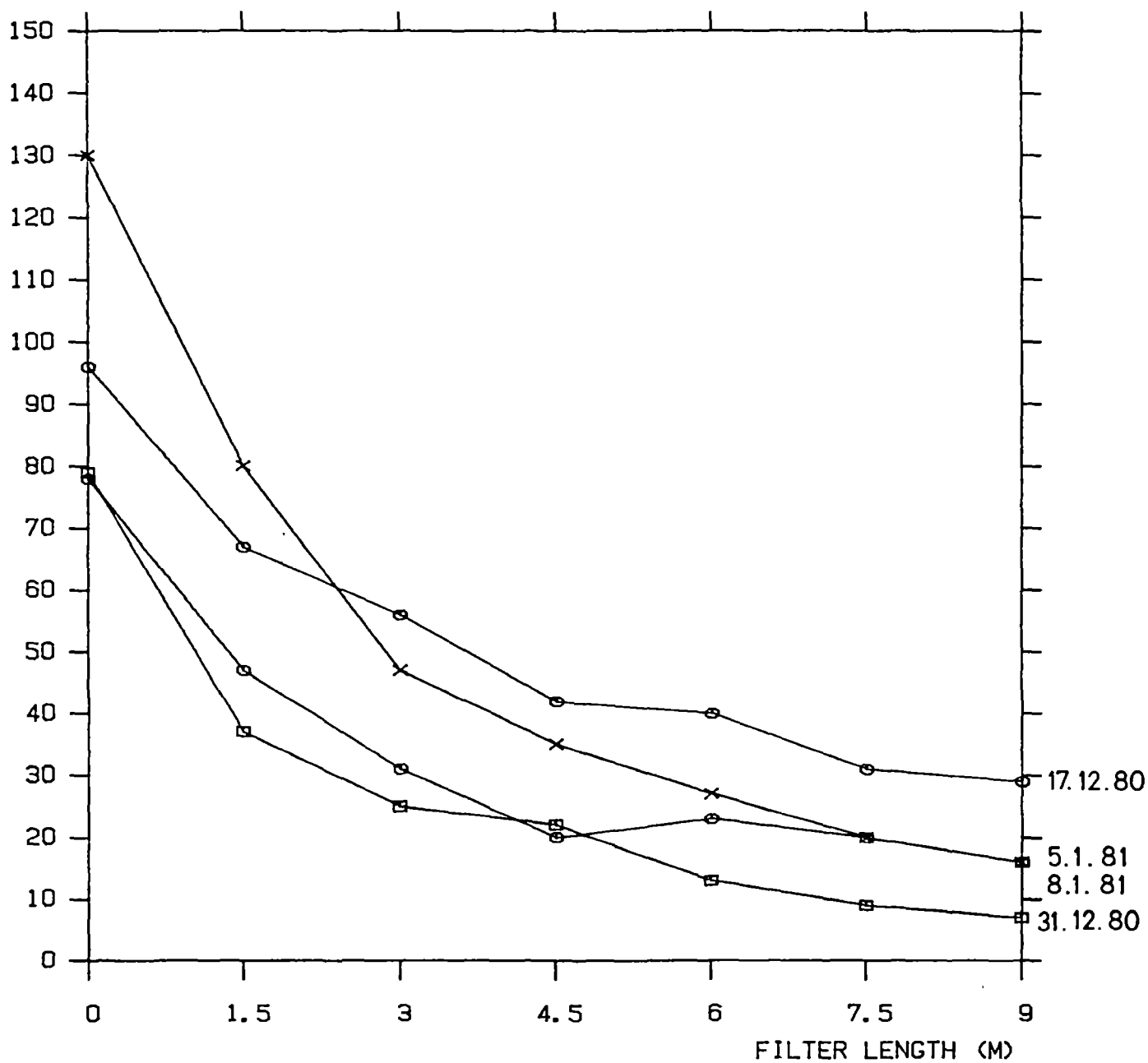

Filtration Rate :  
 □ 0.50 m/hr  
 X 0.75 m/hr  
 ○ 1.00 m/hr

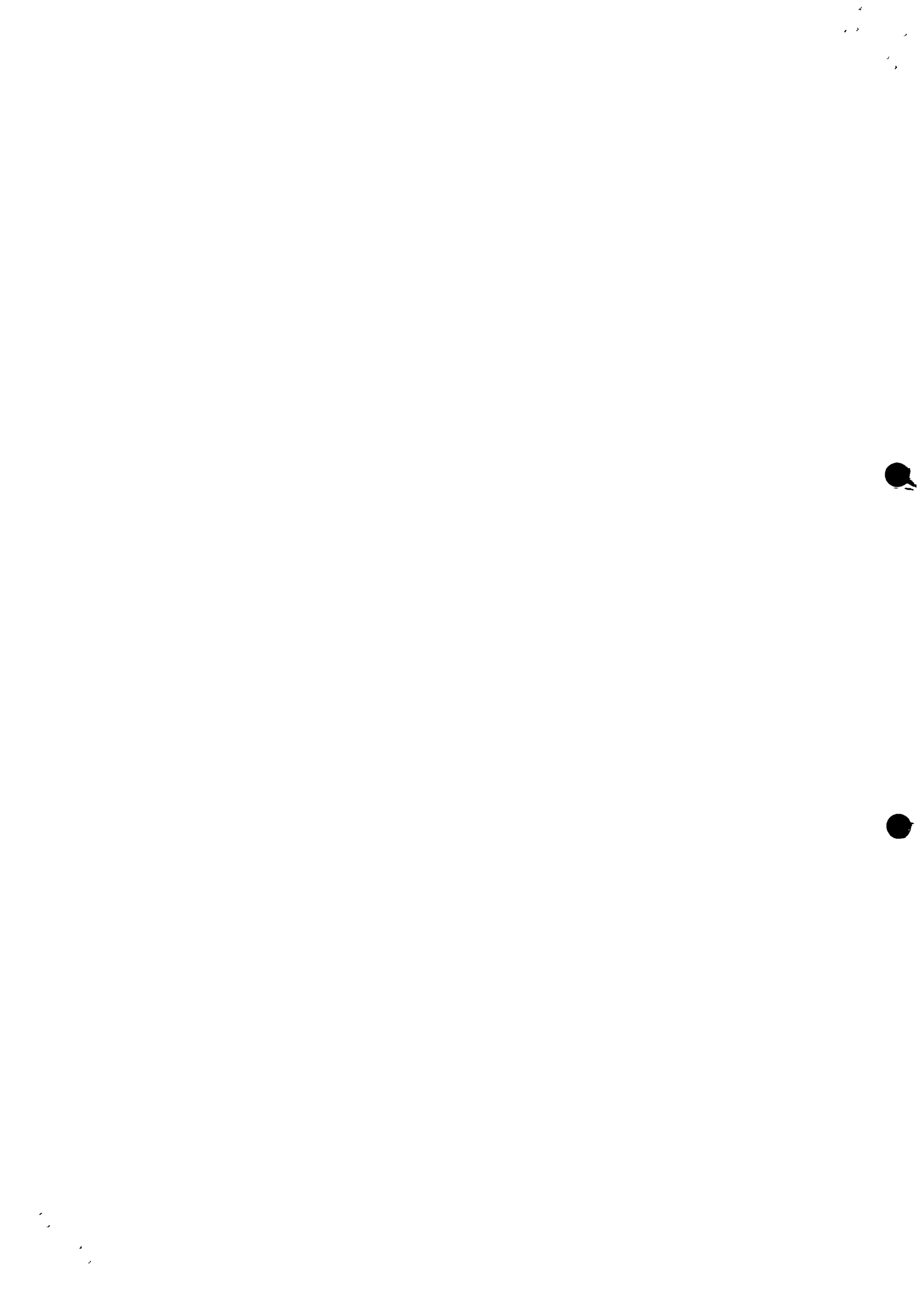

**FILTER RESISTANCE DEVELOPMENT OF SSF IN HANDENI**

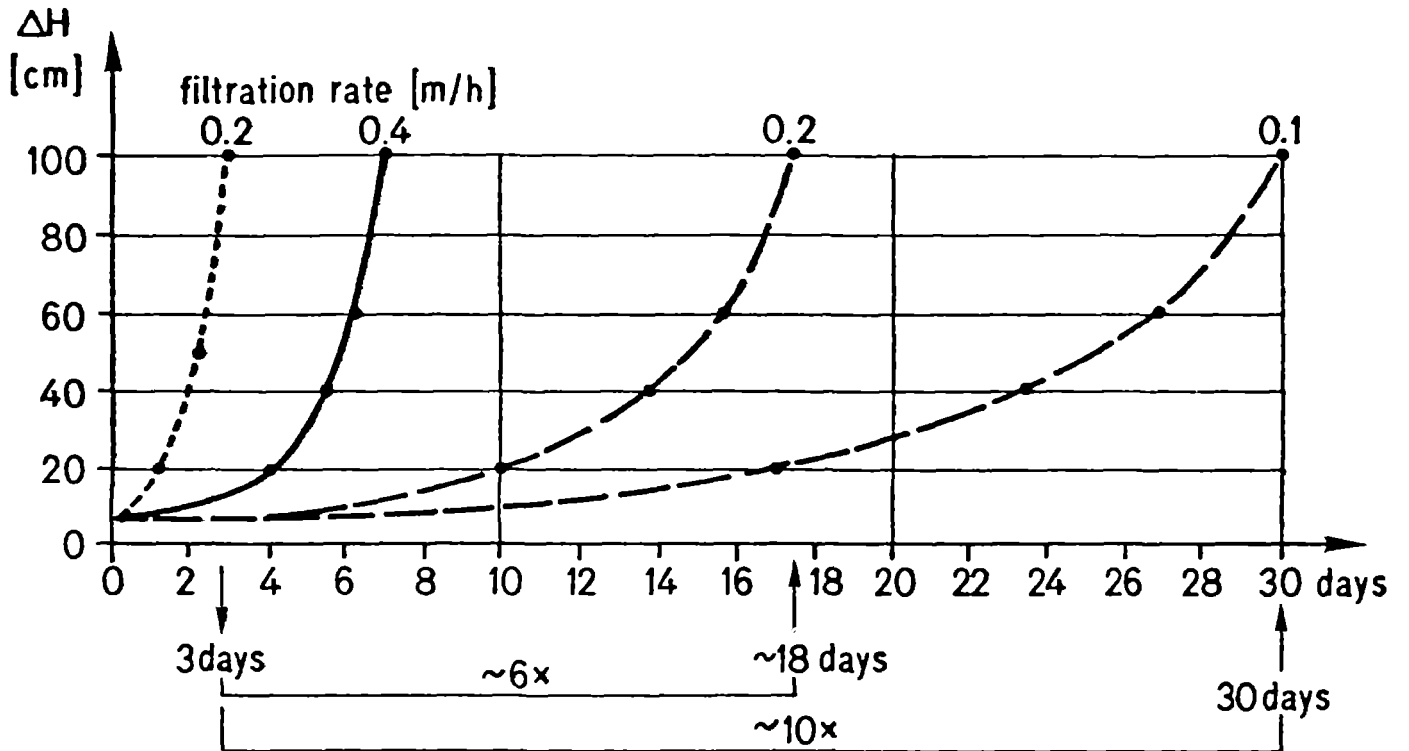

- coagulated water , avg Turbidity 5NTU , real records
- HRF filtered water , avg Turbidity 10NTU , real records
- - - - - HRF filtered water , avg Turbidity 10NTU , extrapolation according NEERI (World Water 9/79)

NEERI in World Water Sept / 79 :

at filtration rate	0.1 m/h	→ filter run	45 days	} <u><math>y = 3.84 \cdot x^{-1.09}</math></u>
"	0.2 m/h	→ filter run	26 days	
"	0.3 m/h	→ filter run	13 days	
	(x)		(y)	

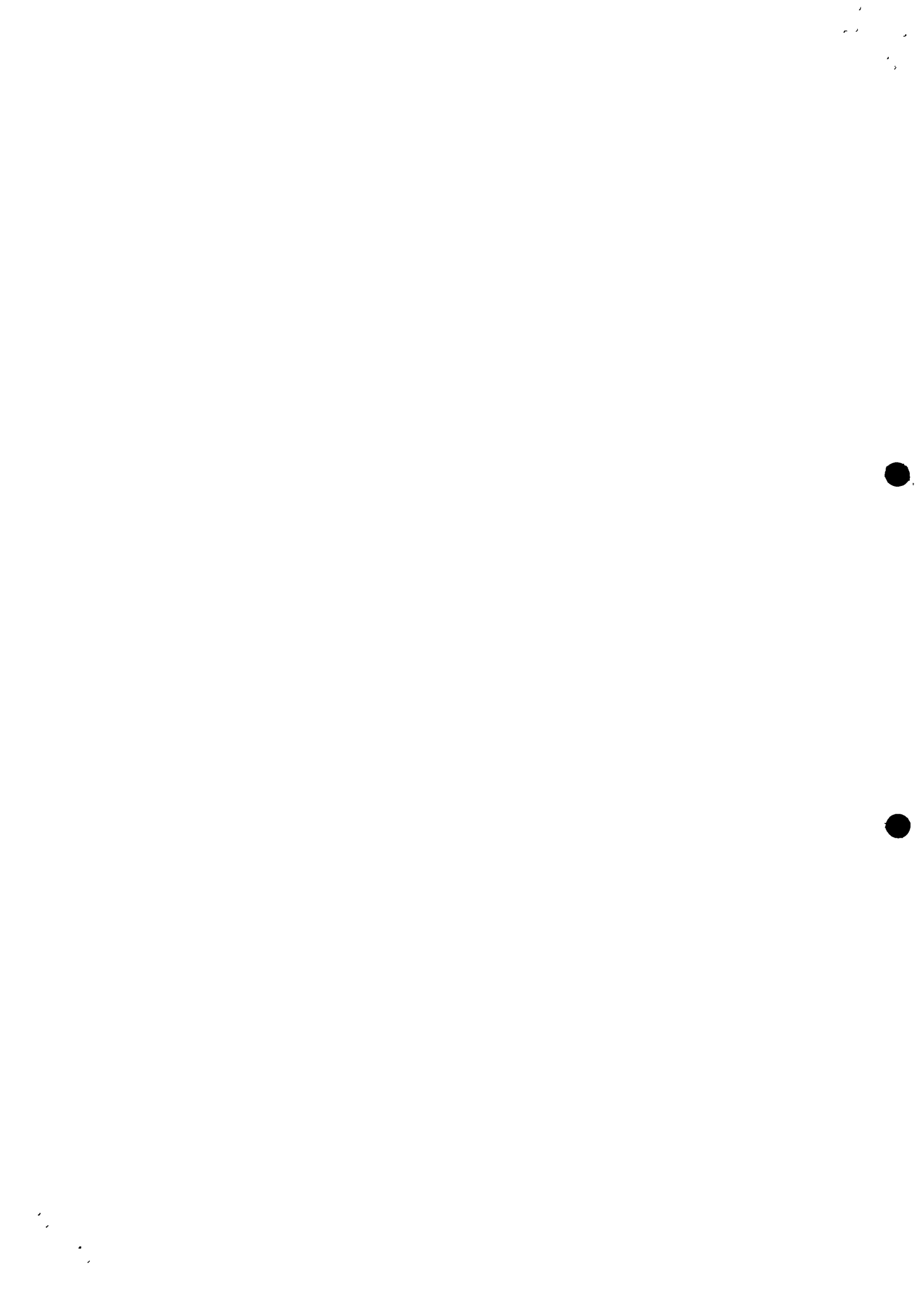

## CORRELATION TURBIDITY – FILTERABILITY FOR HANDENI WATER

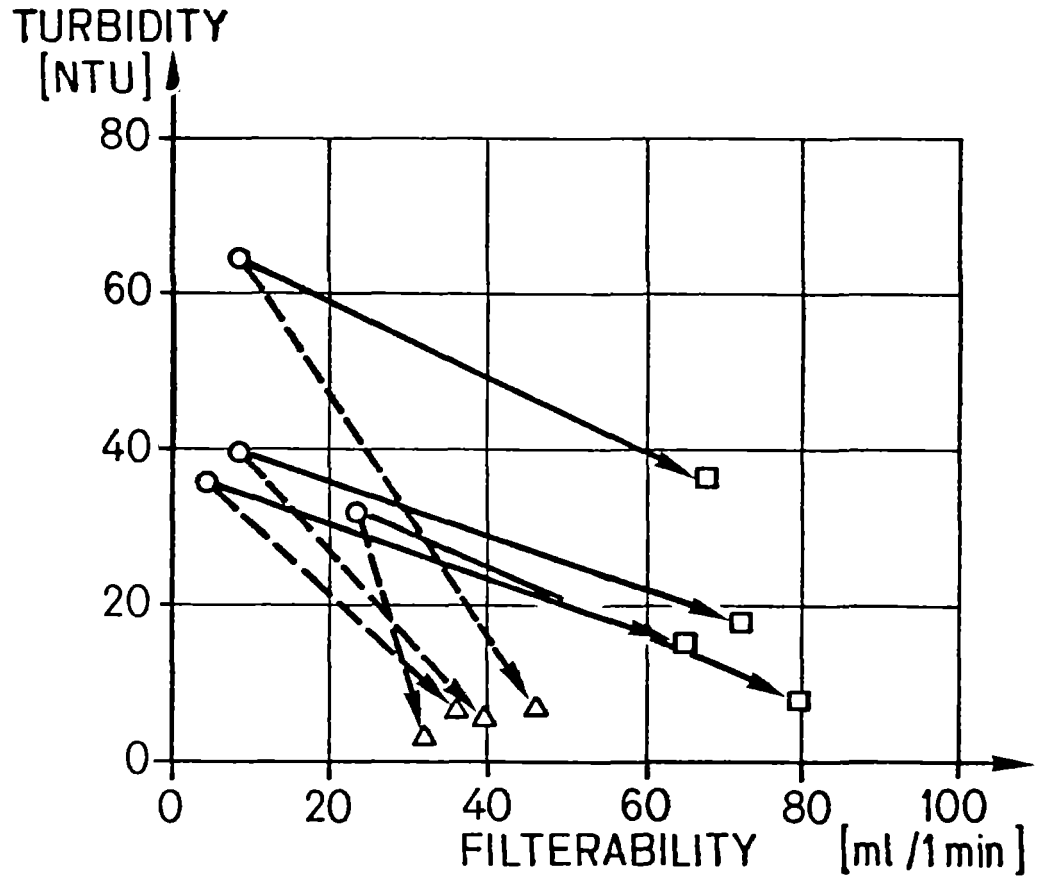

- raw water
- filtrate HRF
- △ coagulated water

(filter paper : Schleicher + Schüll Nr. 595, pore  $\phi$  4.4  $\mu\text{m}$ ,  
Filtration Time Herzberg 160 s)

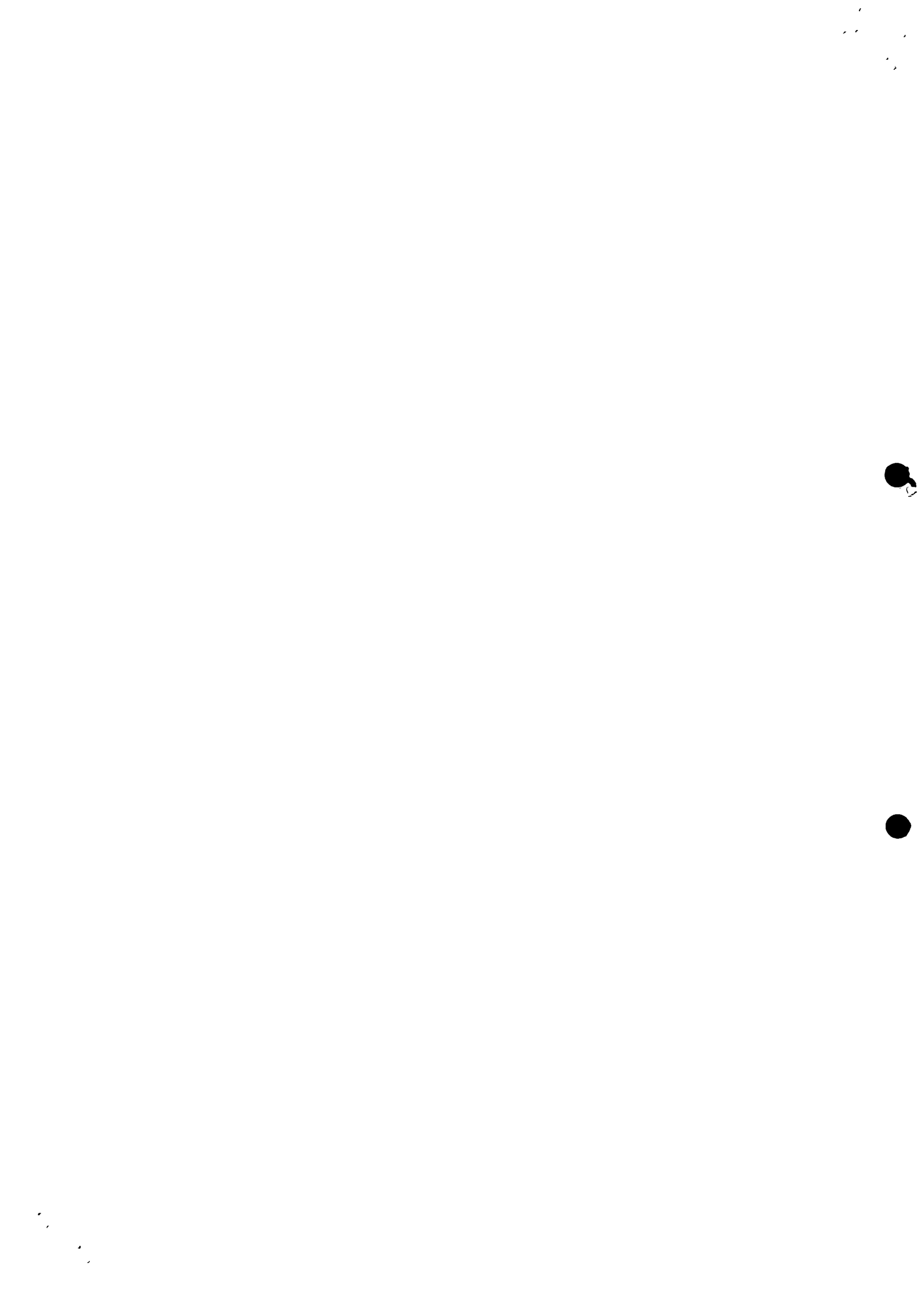



# CORRELATION TURBIDITY – LEGIBILITY FOR HANDENI WATER

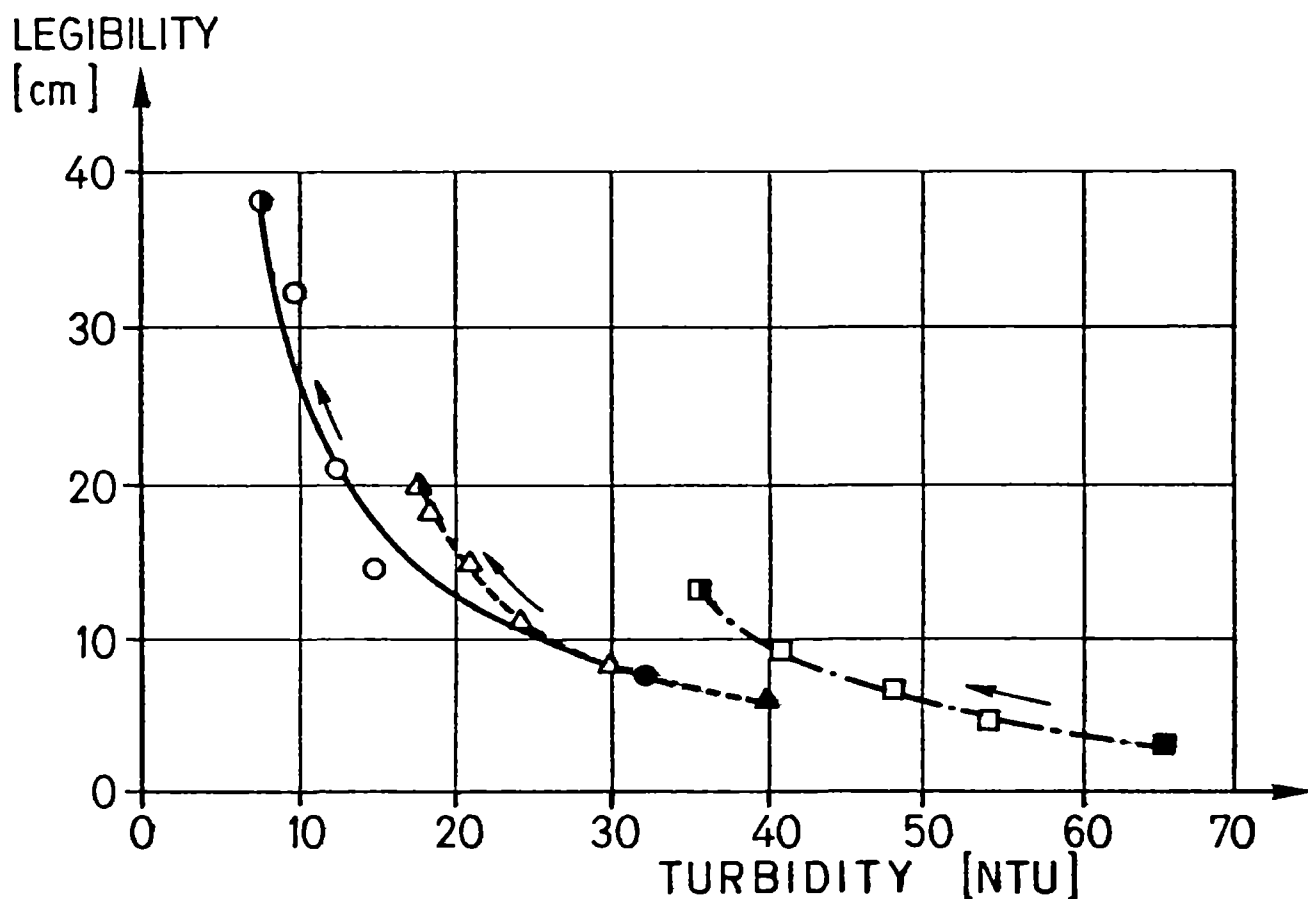

○ 0.5 m/h  
 △ 1.0 m/h  
 □ 1.5 m/h  
 } filtration rate

● } raw water  
 ▲ }  
 ■ }

○ } filtrate HRF  
 ▲ }  
 □ }

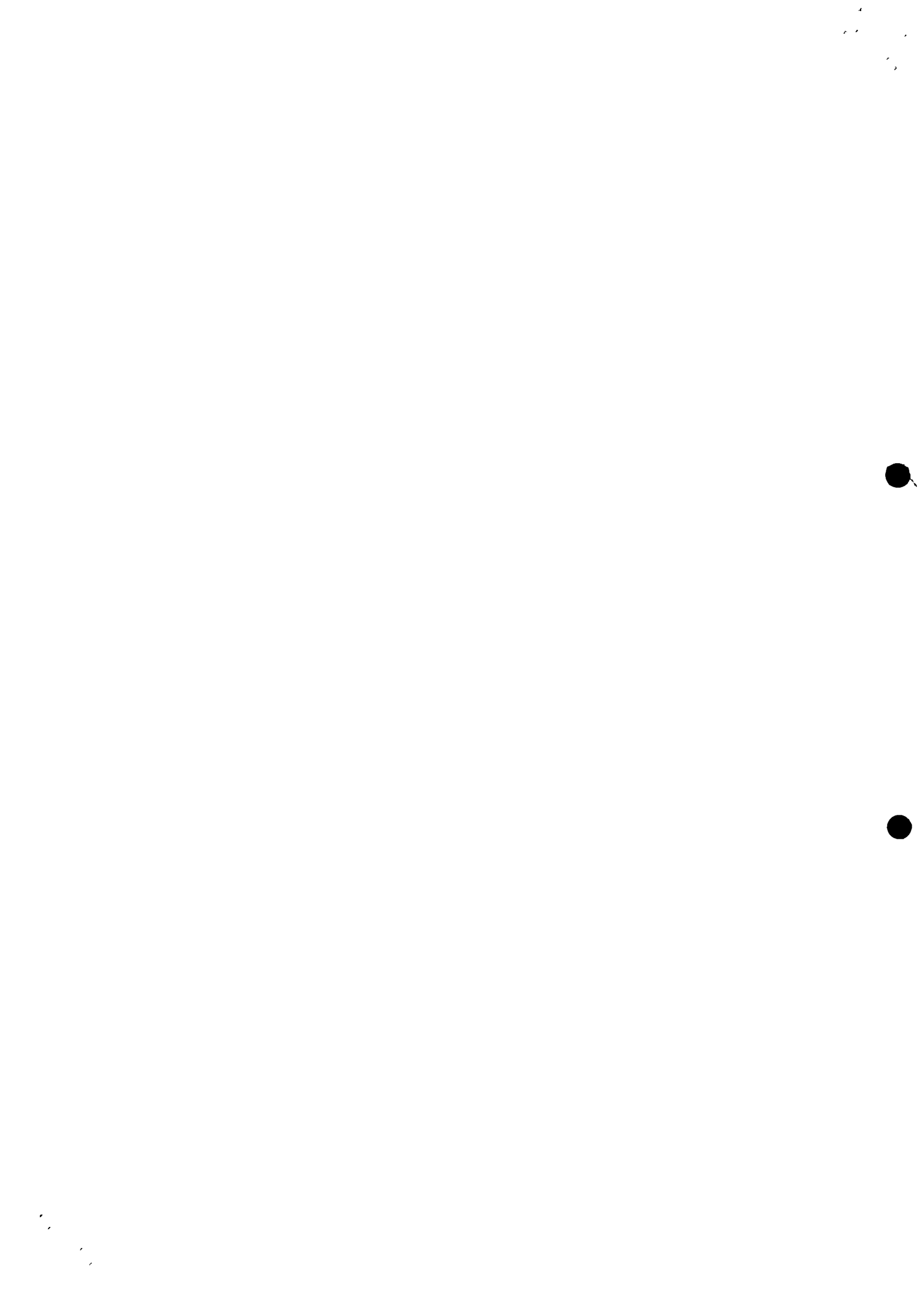

FILTERABILITY (ML/MIN)

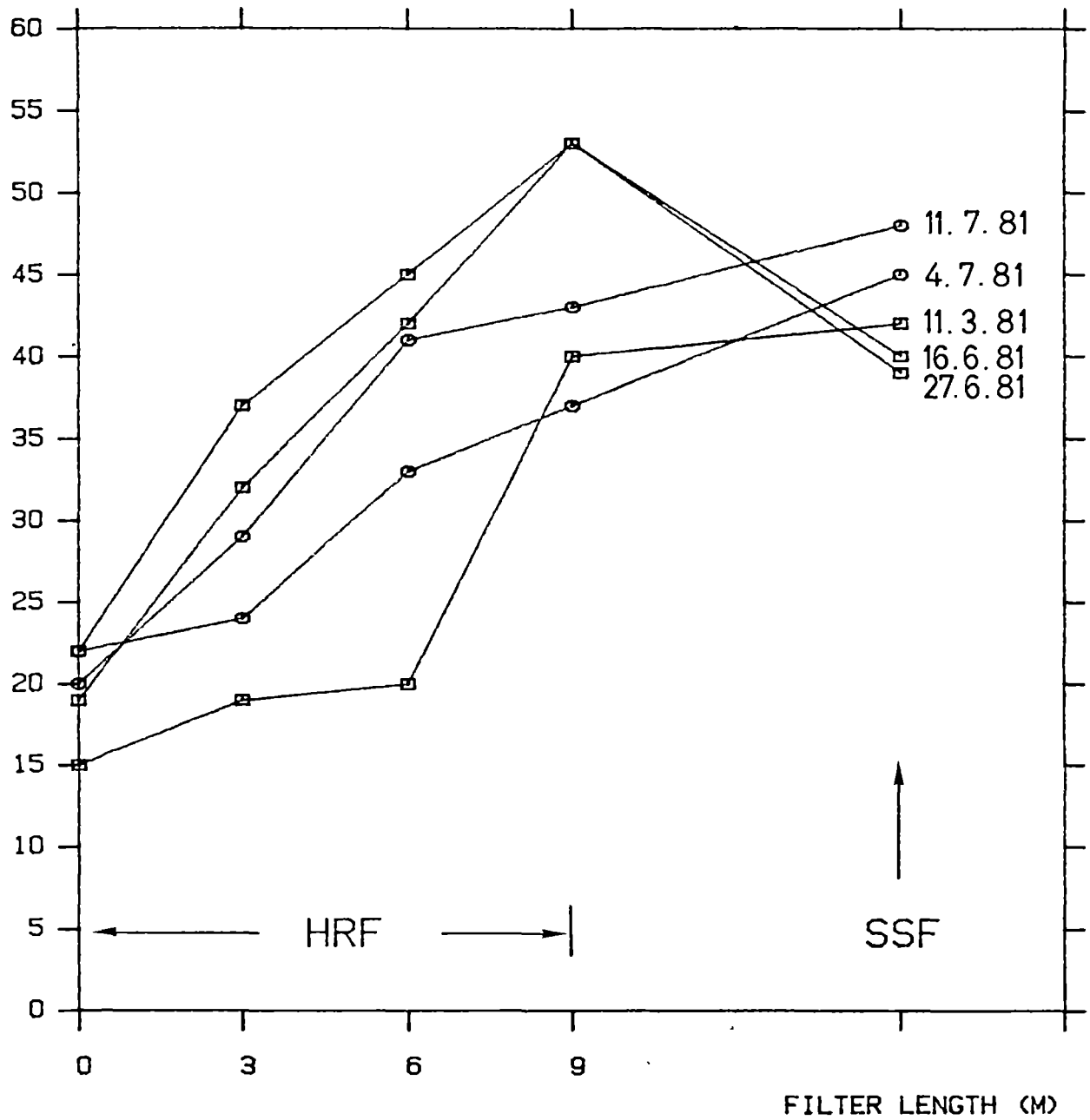

Filtration Rate :    □ 0.5 m/hr  
                           ○ 1.0 m/hr

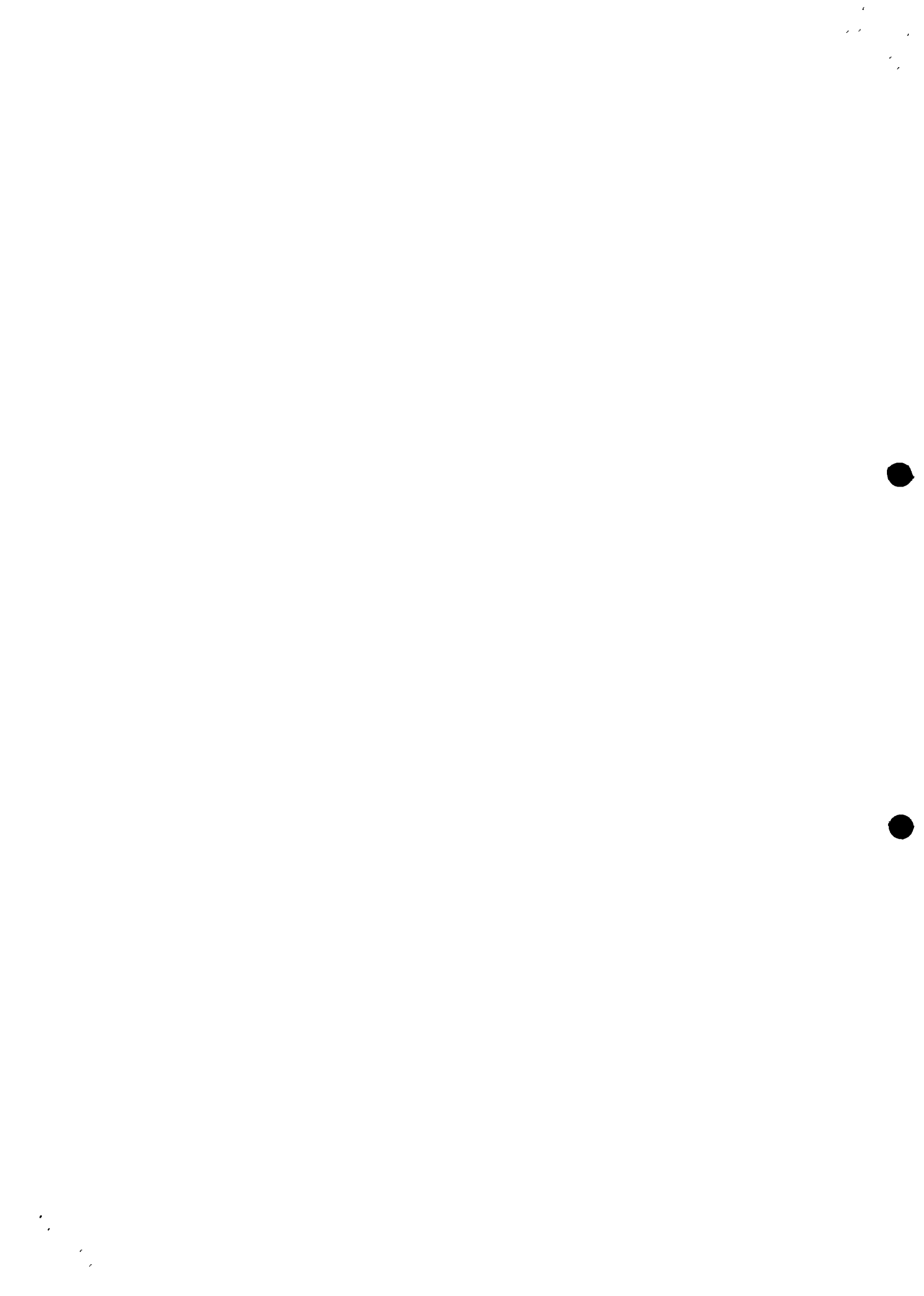

FILTER RESISTANCE (CM)

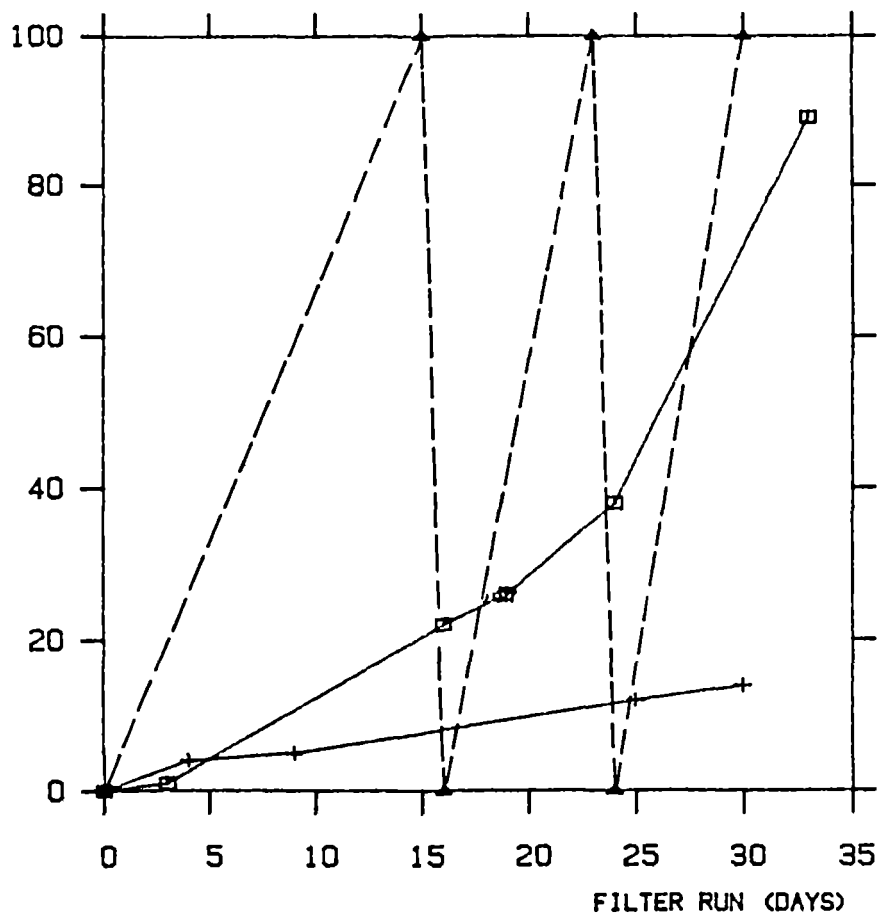

Period February/March 81

- big model without pretrmt
- △ small model without pretrmt
- + small model with pretrmt

FILTER RESISTANCE (CM)

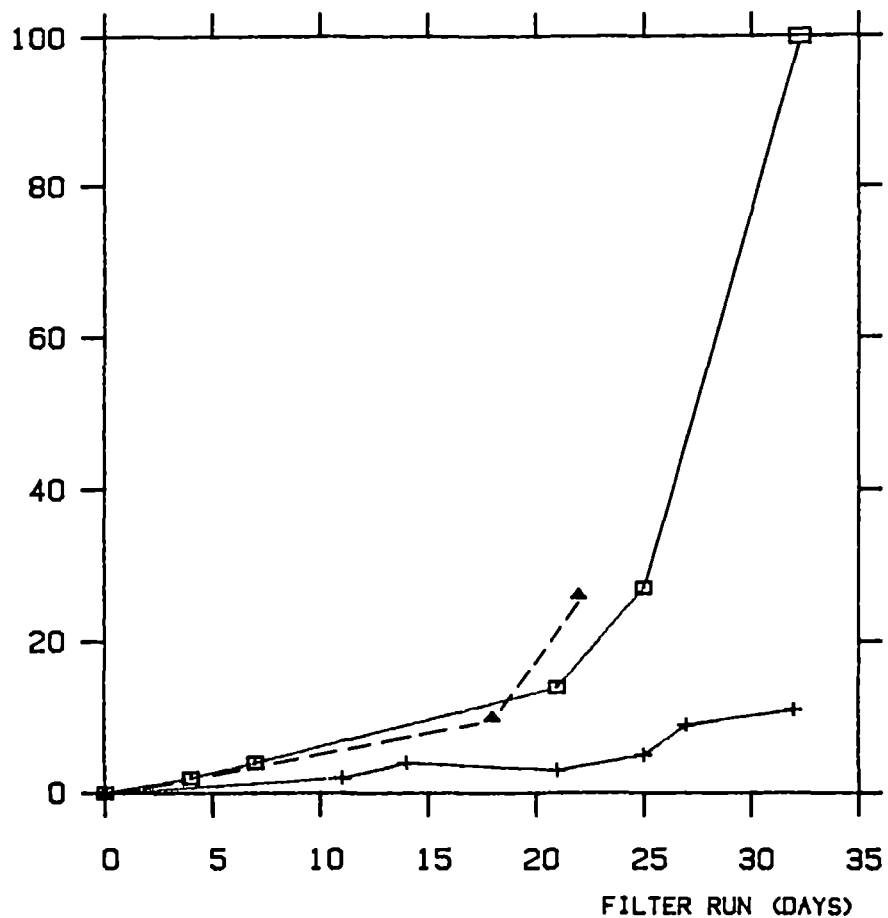

Period June - August 81

- big model without pretrmt
- △ small model without pretrmt
- + small model with pretrmt

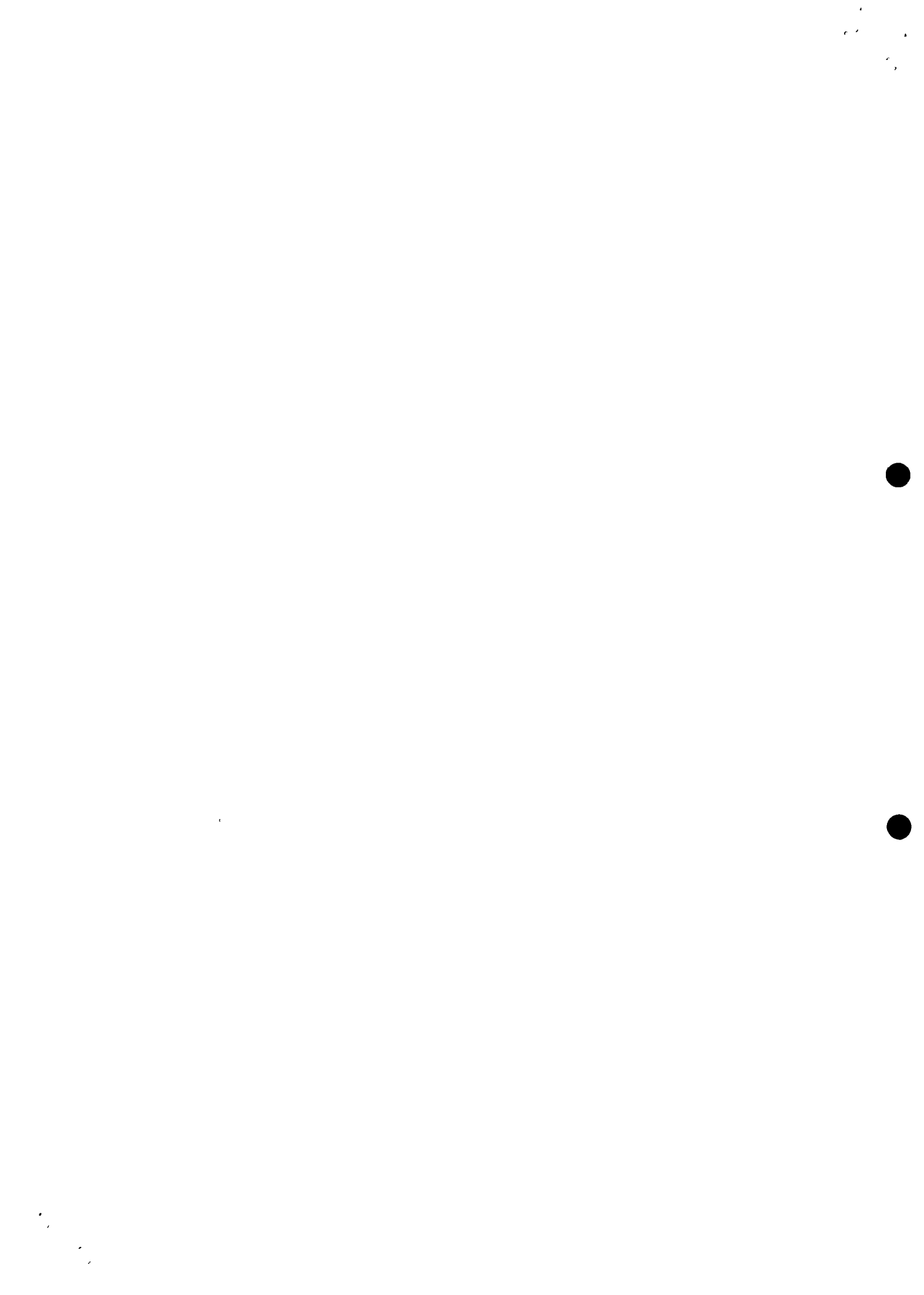

COLOUR (mg Pt/l)  
TURBIDITY (NTU)

LEGIBILITY (CM)

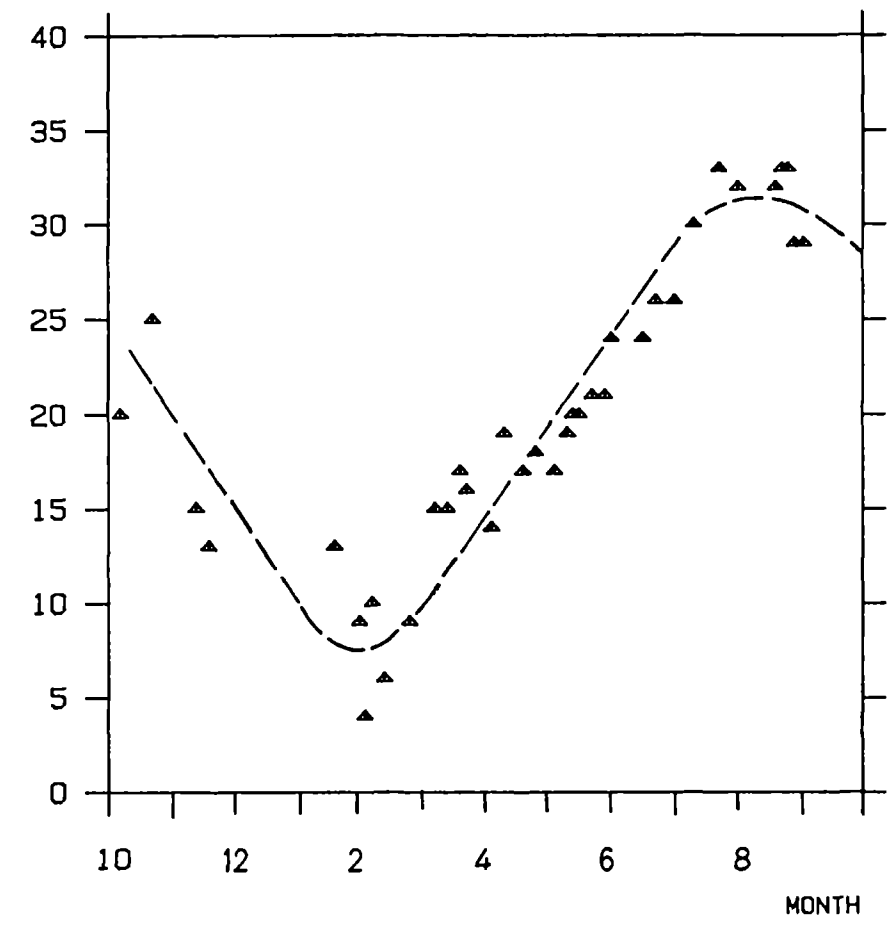
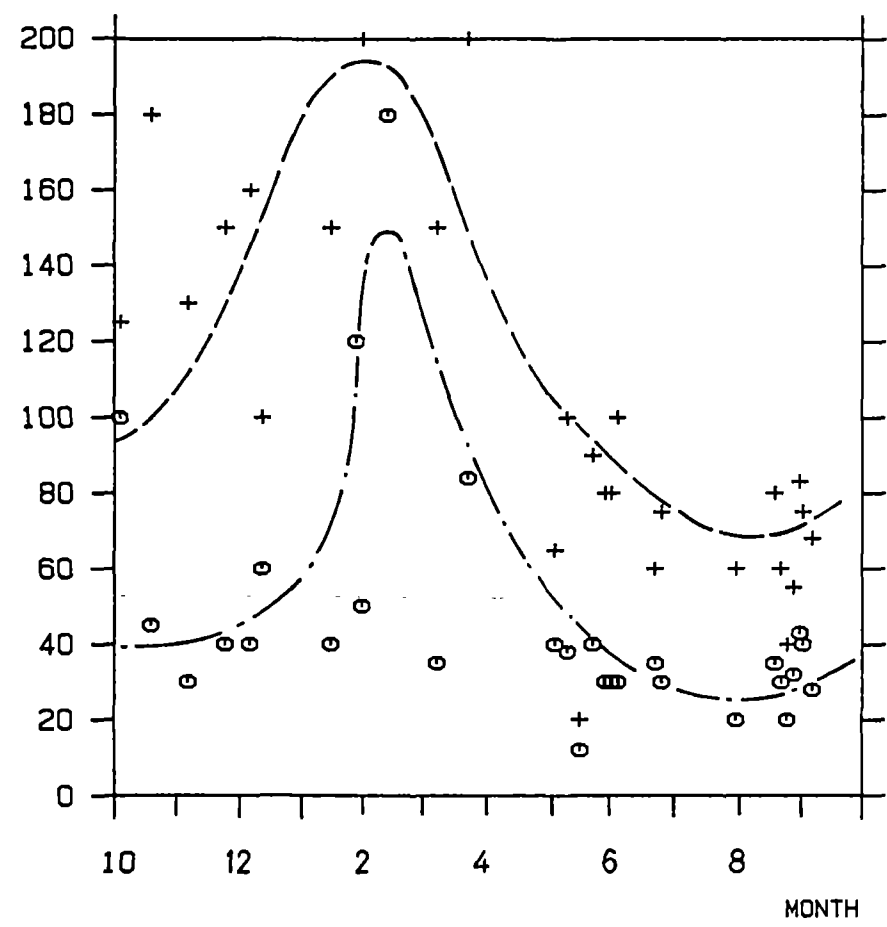

Period October 80 - September 81

+---+ COLOUR  
o---o TURBIDITY  
△---△ LEGIBILITY

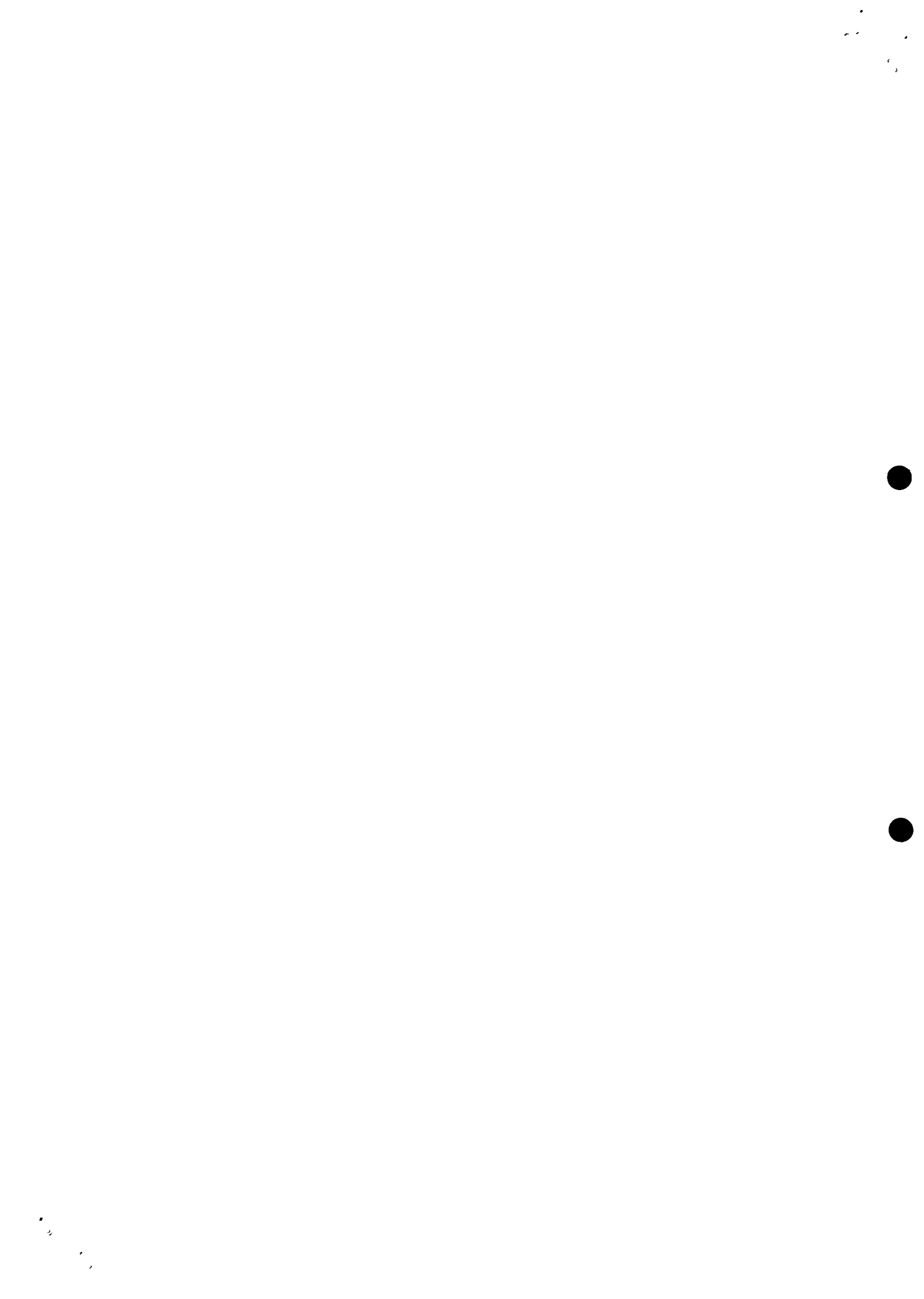



Period 7.4. - 30.5.81

TURBIDITY (NTU)

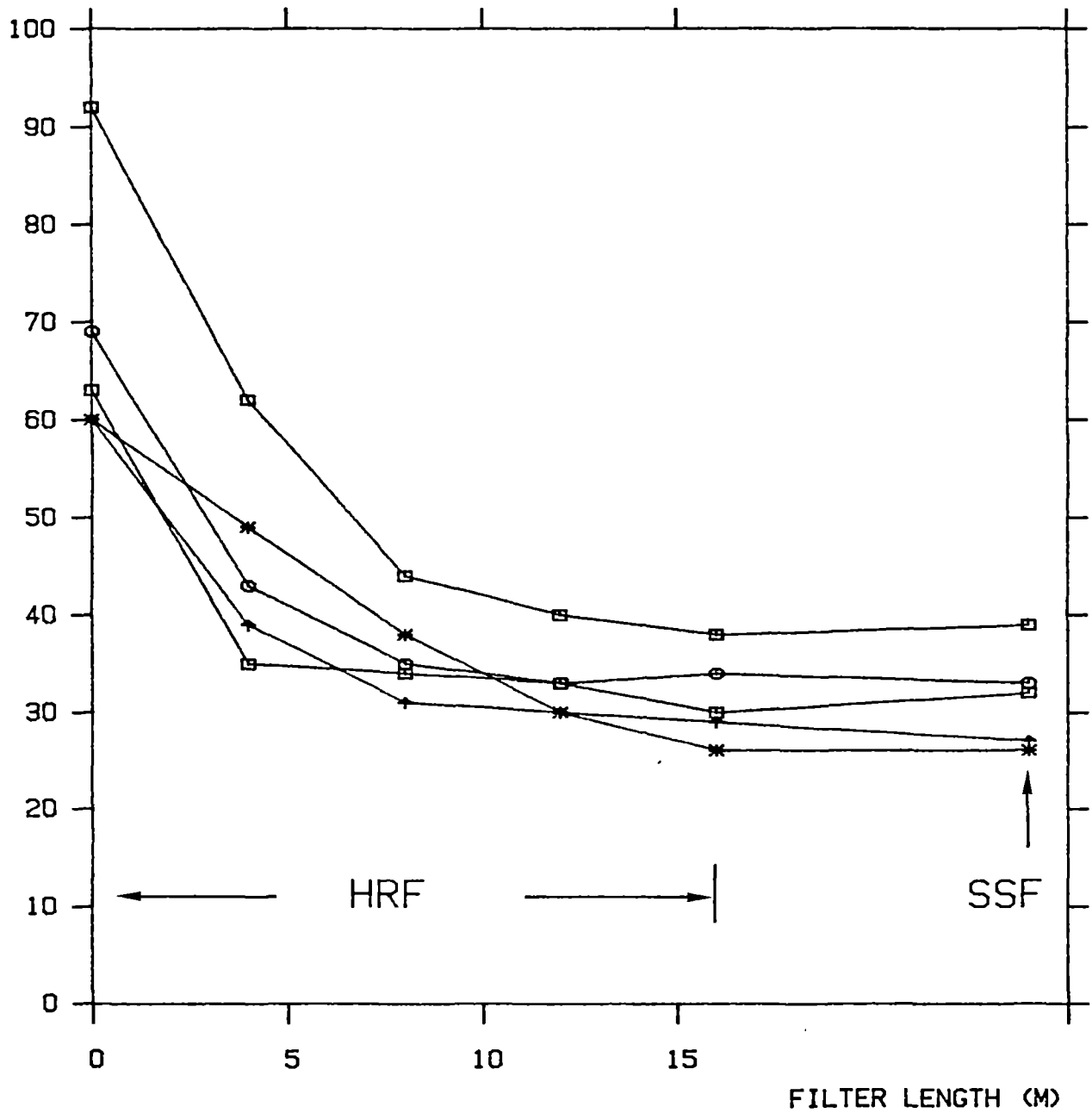

Filtration Rate :

□ 0.5 m/hr

○ 1.0 m/hr

▲ 1.0 / 0.5 m/hr

\* 2.0 / 1.0 m/hr

throughout the HRF

throughout the HRF

1. +2. / 3. +4. compartment

1. +2. / 3. +4. compartment

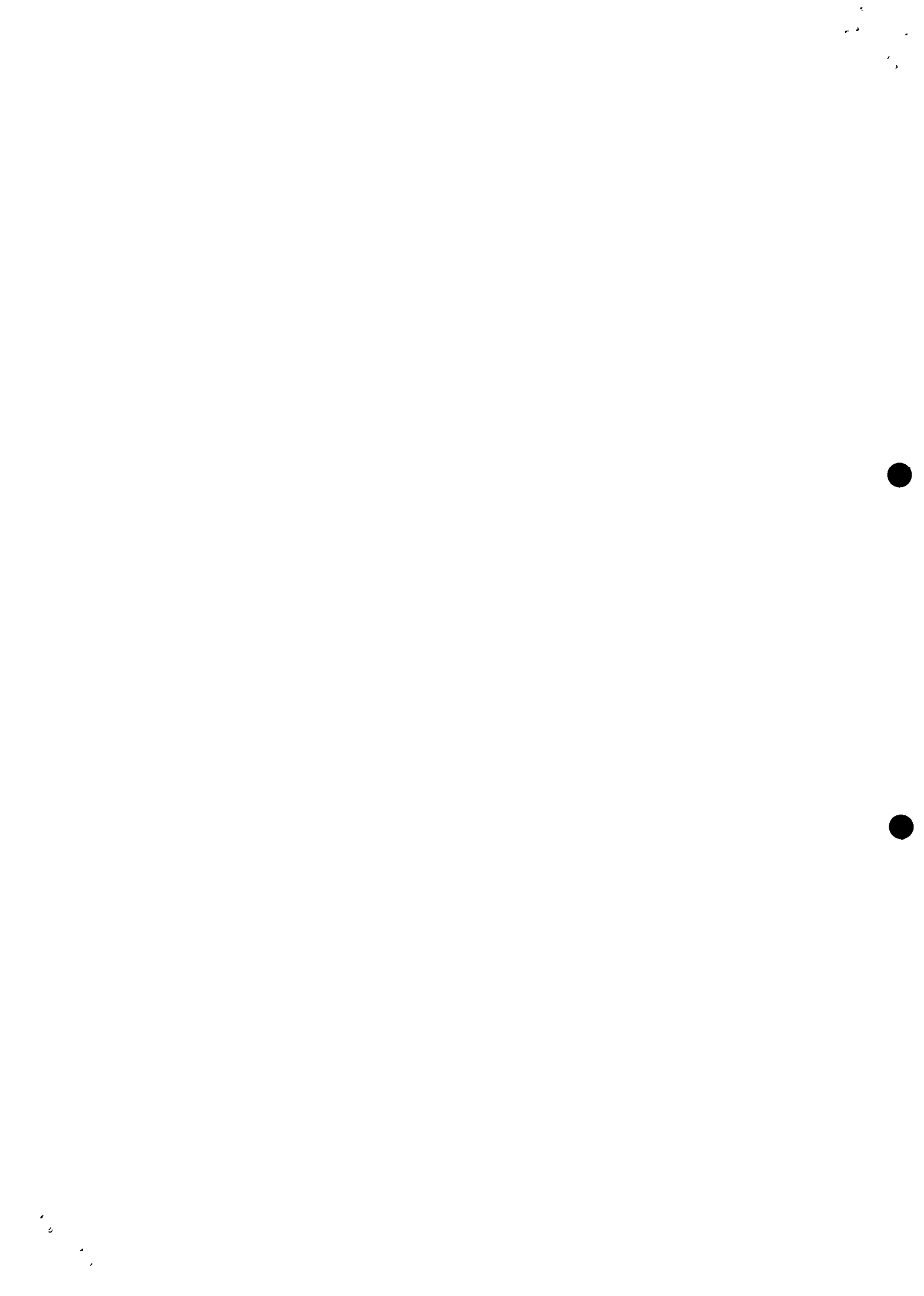

TURBIDITY (NTU)

Period 1.6. - 25.6.81

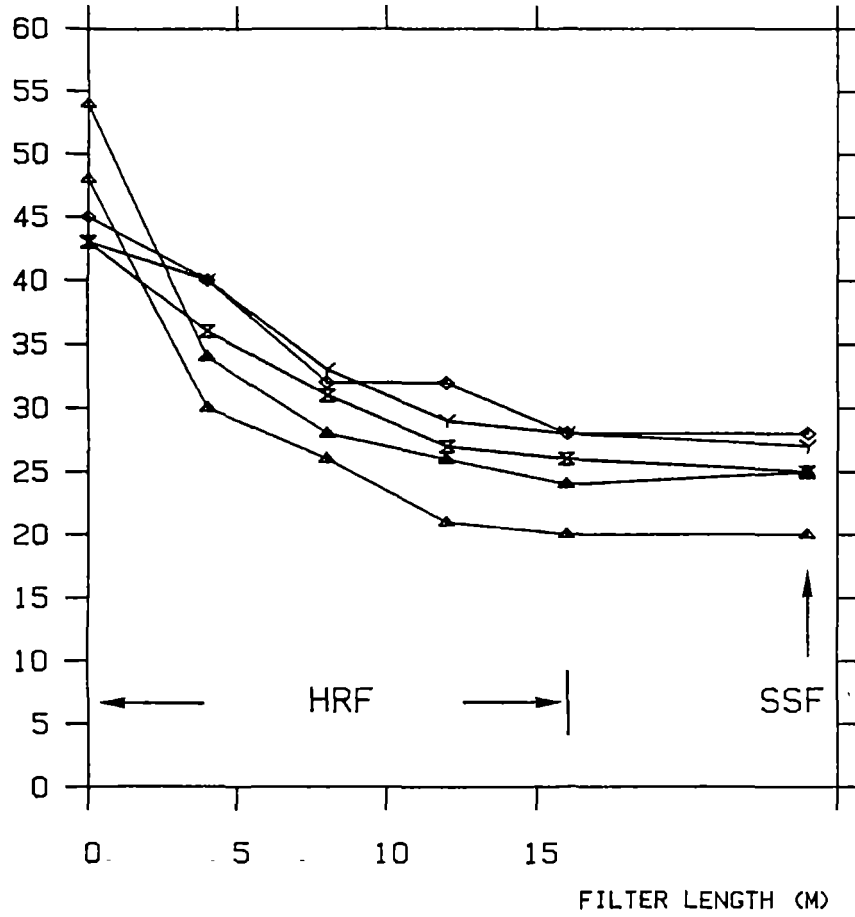

Filtration Rate :  
 △ 2.0 m/hr  
 ◇ 3.0 m/hr  
 ⊗ 4.0 m/hr  
 Y 5.0 m/hr

TURBIDITY (NTU)

Period 14.8. - 3.9.81

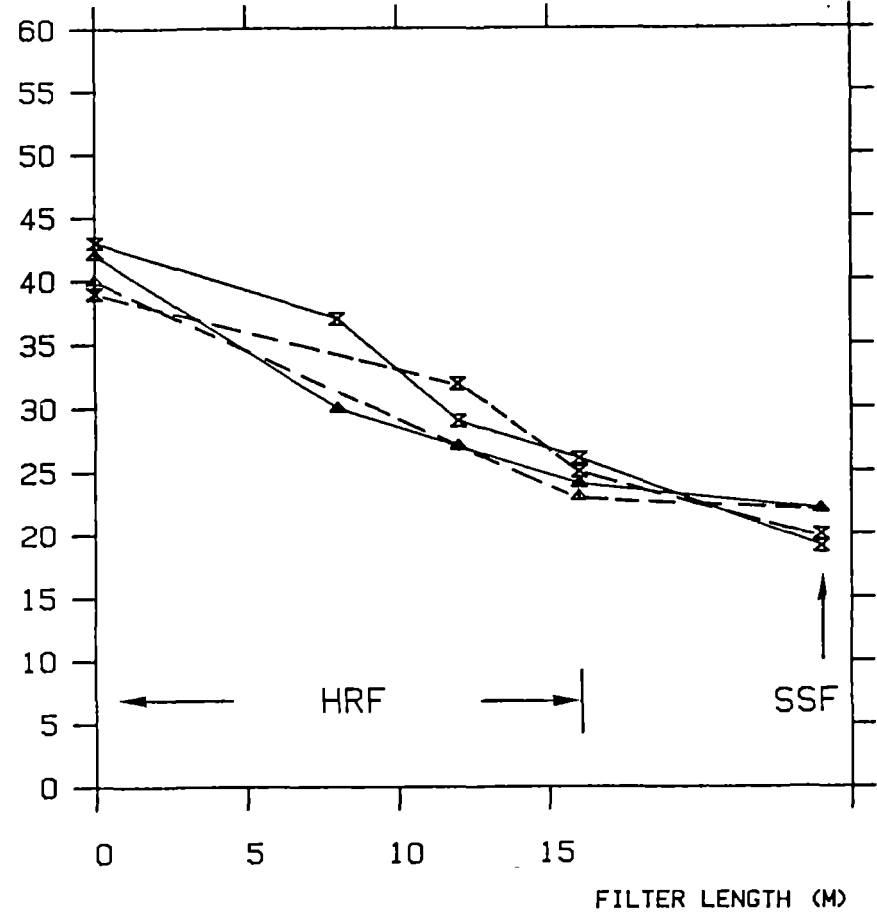

Filtration Rate :  
 △ 2.0 m/hr  
 ◇ 3.0 m/hr  
 ⊗ 4.0 m/hr  
 — 1st compartment by-passed  
 - - - 1st + 2nd compartment by-passed

TURBIDITY REDUCTION WITH HRF IN IRINGA

APPENDIX 18/2

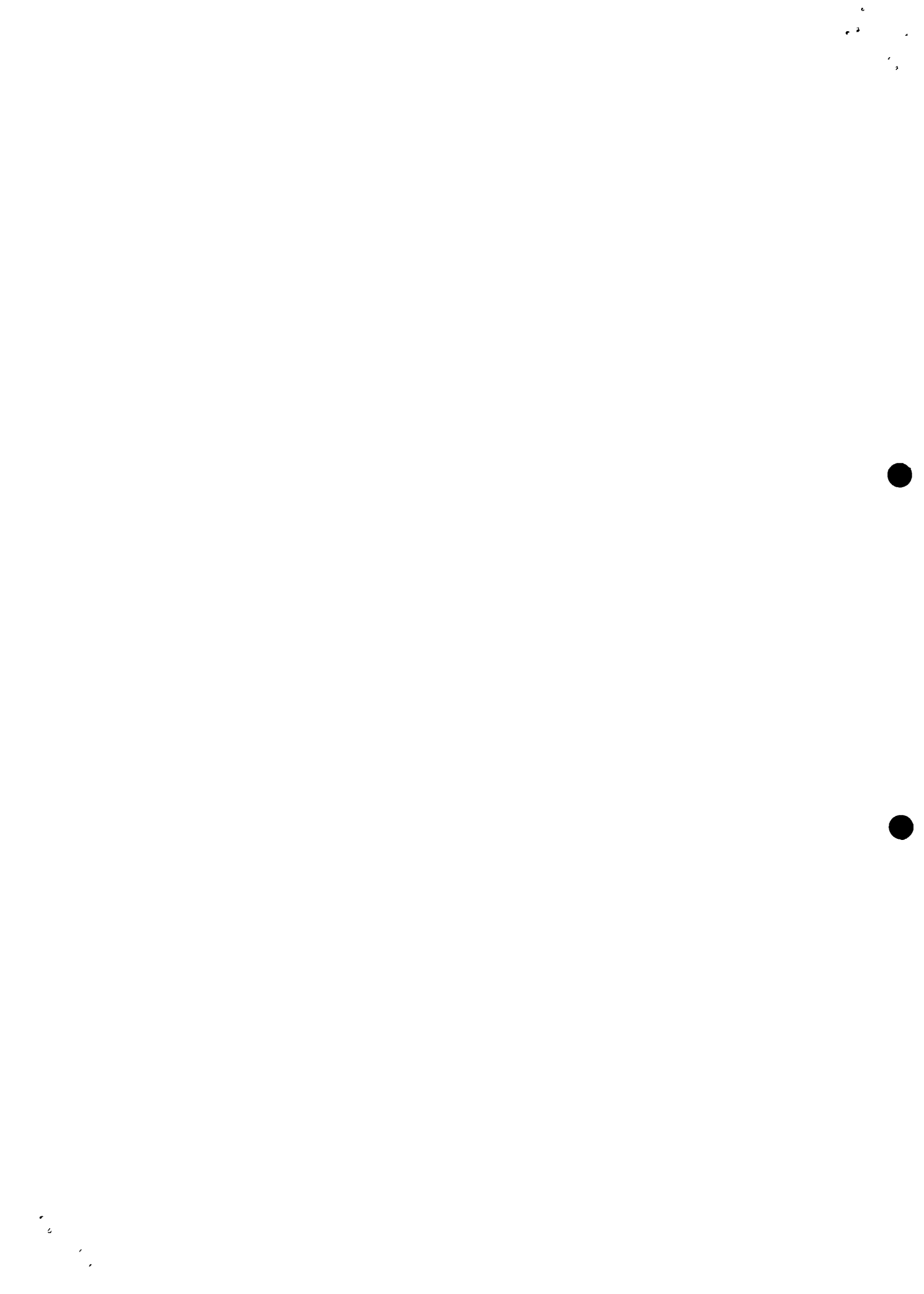

Period 7.4. - 30.5.81

FILTERABILITY (ML/MIN)

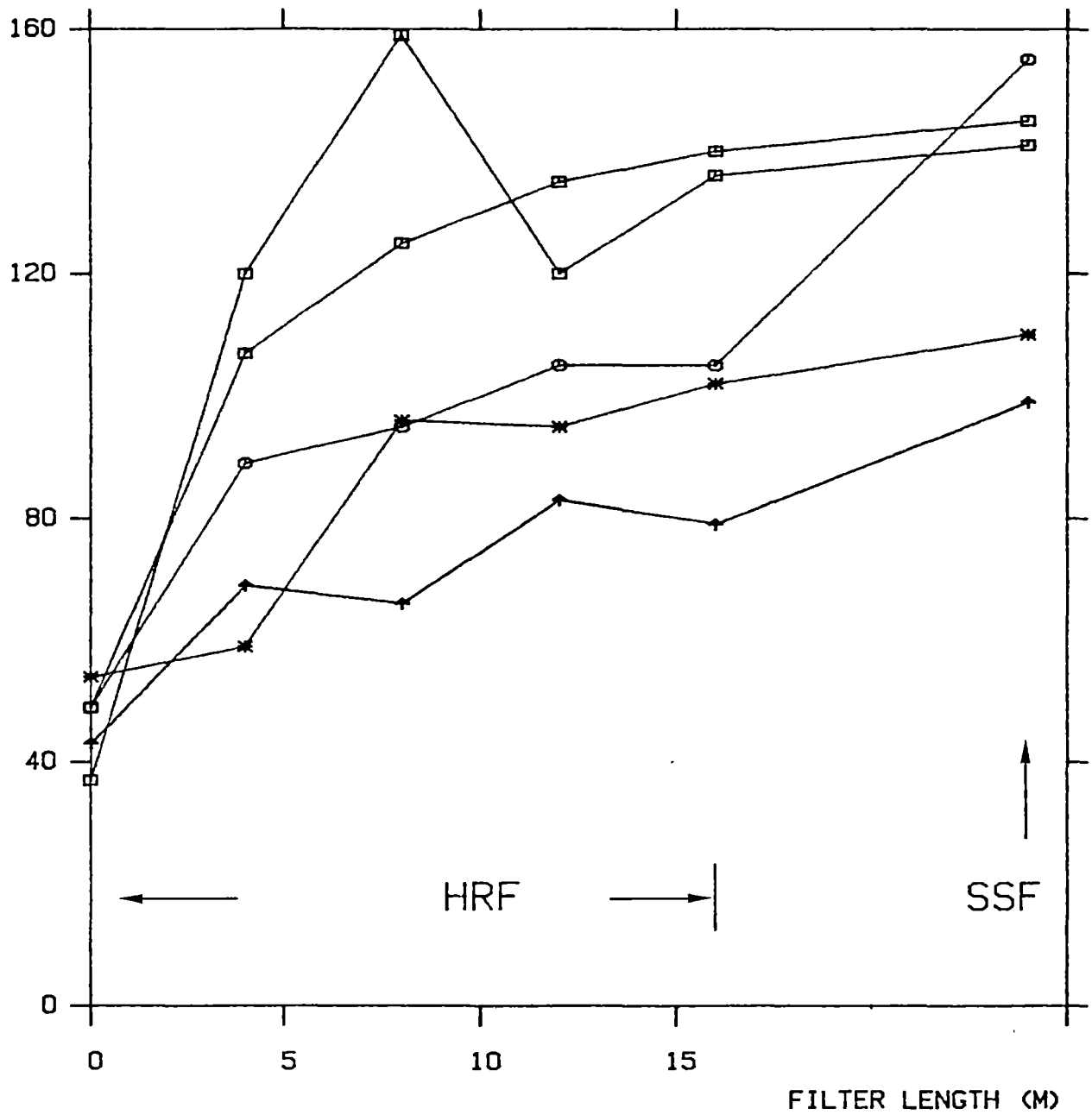

Filtration Rate :

- 0.5 m/hr throughout the HRF
- 1.0 m/hr throughout the HRF
- ▲ 1.0 / 0.5 m/hr for 1.+2./3.+4. compartment
- \* 2.0 / 1.0 m/hr for 1.+2./3.+4. compartment

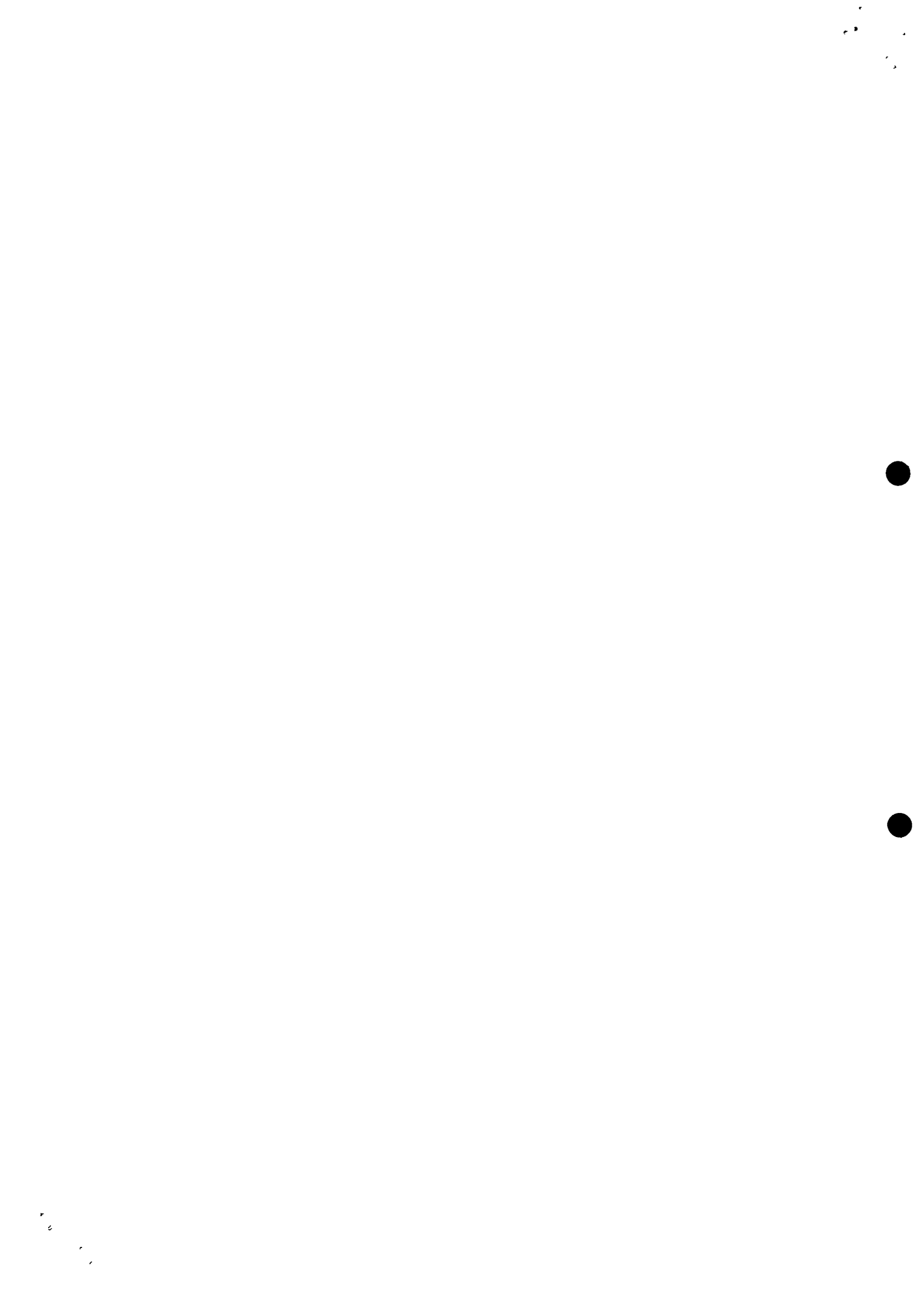

FILTERABILITY (ML/MIN)

Period 1.6. - 25.6.81

FILTERABILITY (ML/MIN)

Period 14.8. - 3.9.81

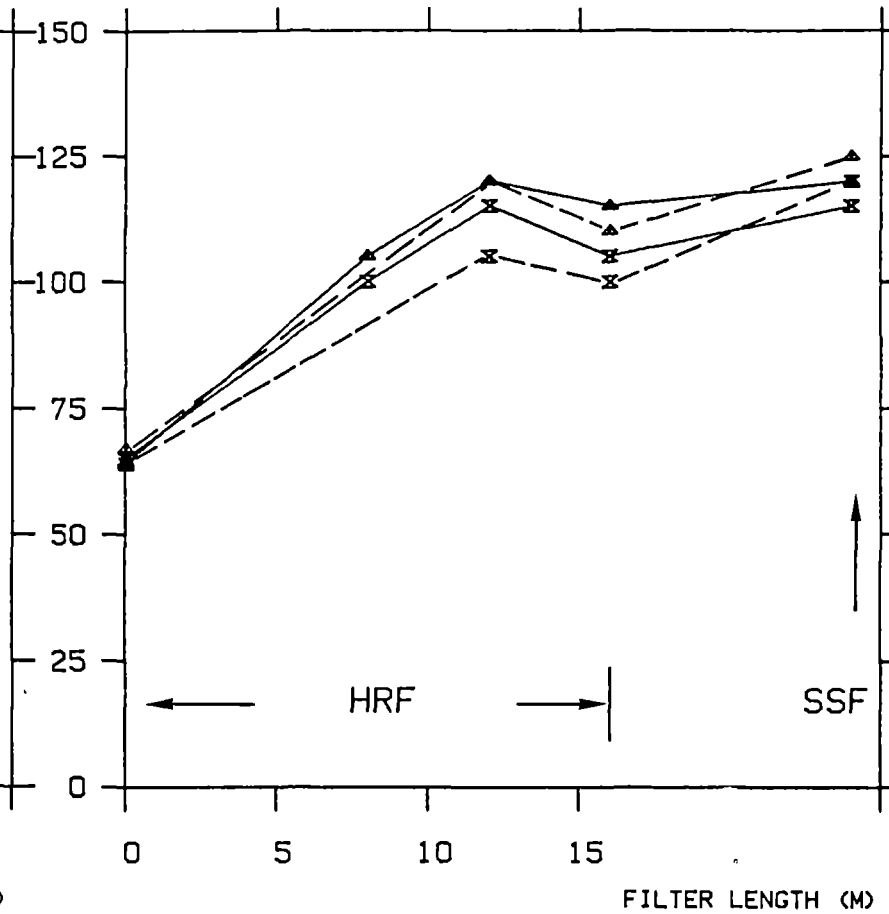
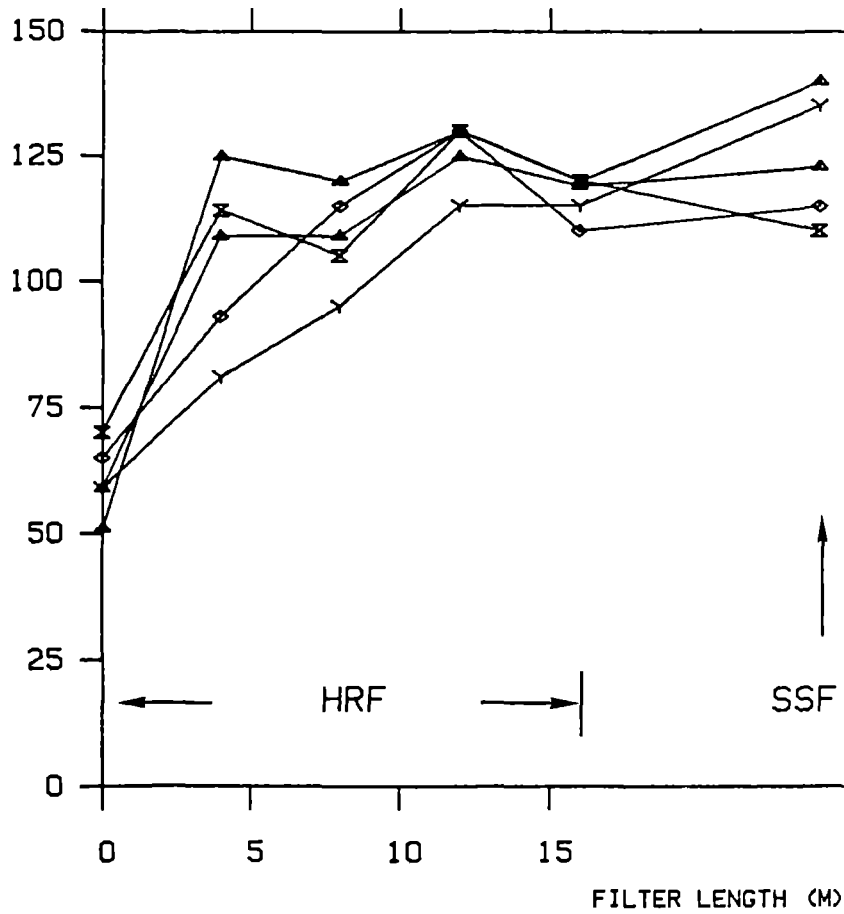

Filtration Rate  
 △ 2.0 m/hr  
 ◇ 3.0 m/hr  
 ⊗ 4.0 m/hr  
 Y 5.0 m/hr

Filtration Rate  
 △ 2.0 m/hr  
 ⊗ 4.0 m/hr  
 — 1st compartment by-passed  
 --- 1st + 2nd compartment by-passed

FILTERABILITY IMPROVEMENT WITH HRF IN IRINGA

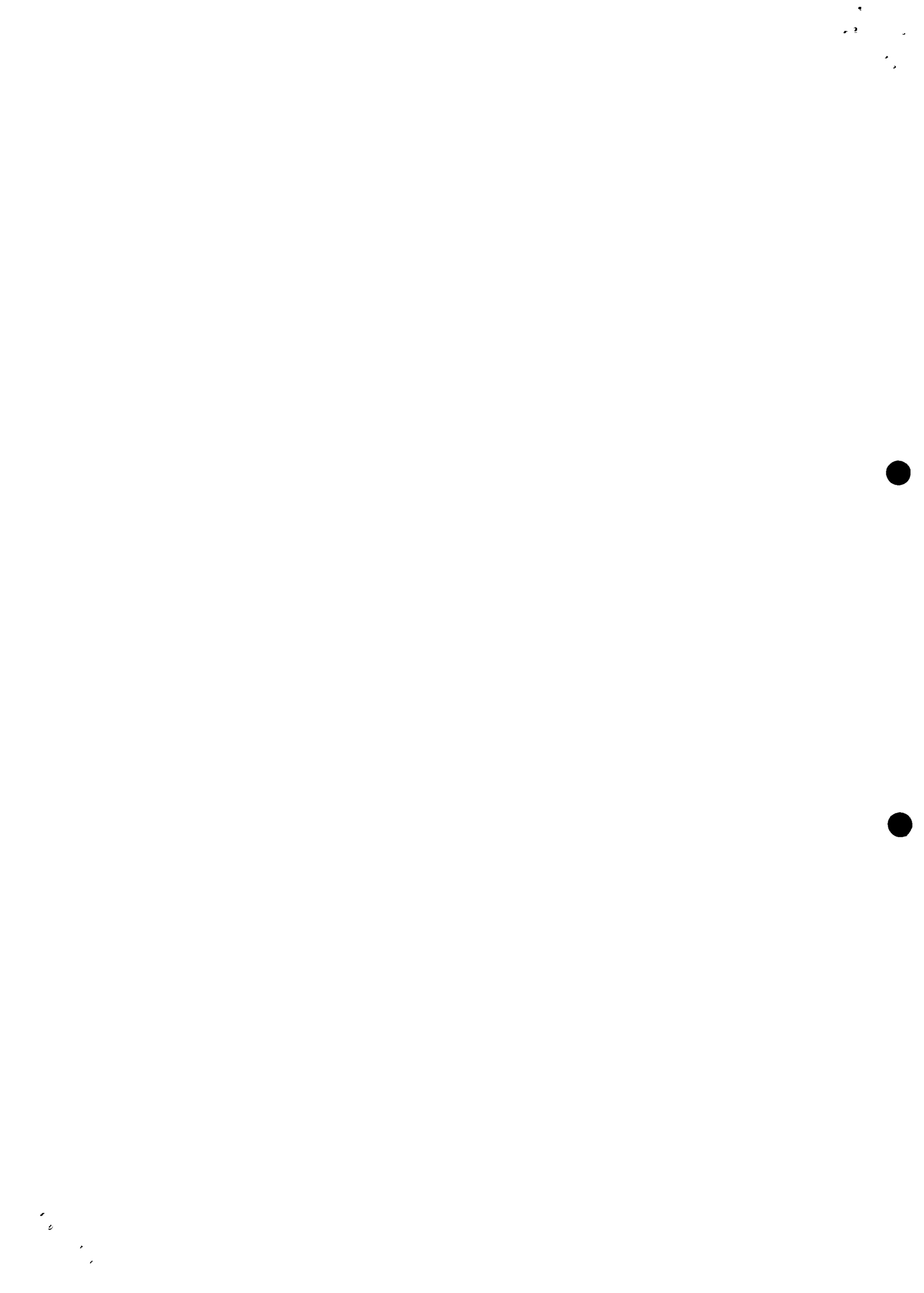



FILTER RESISTANCE (CM)

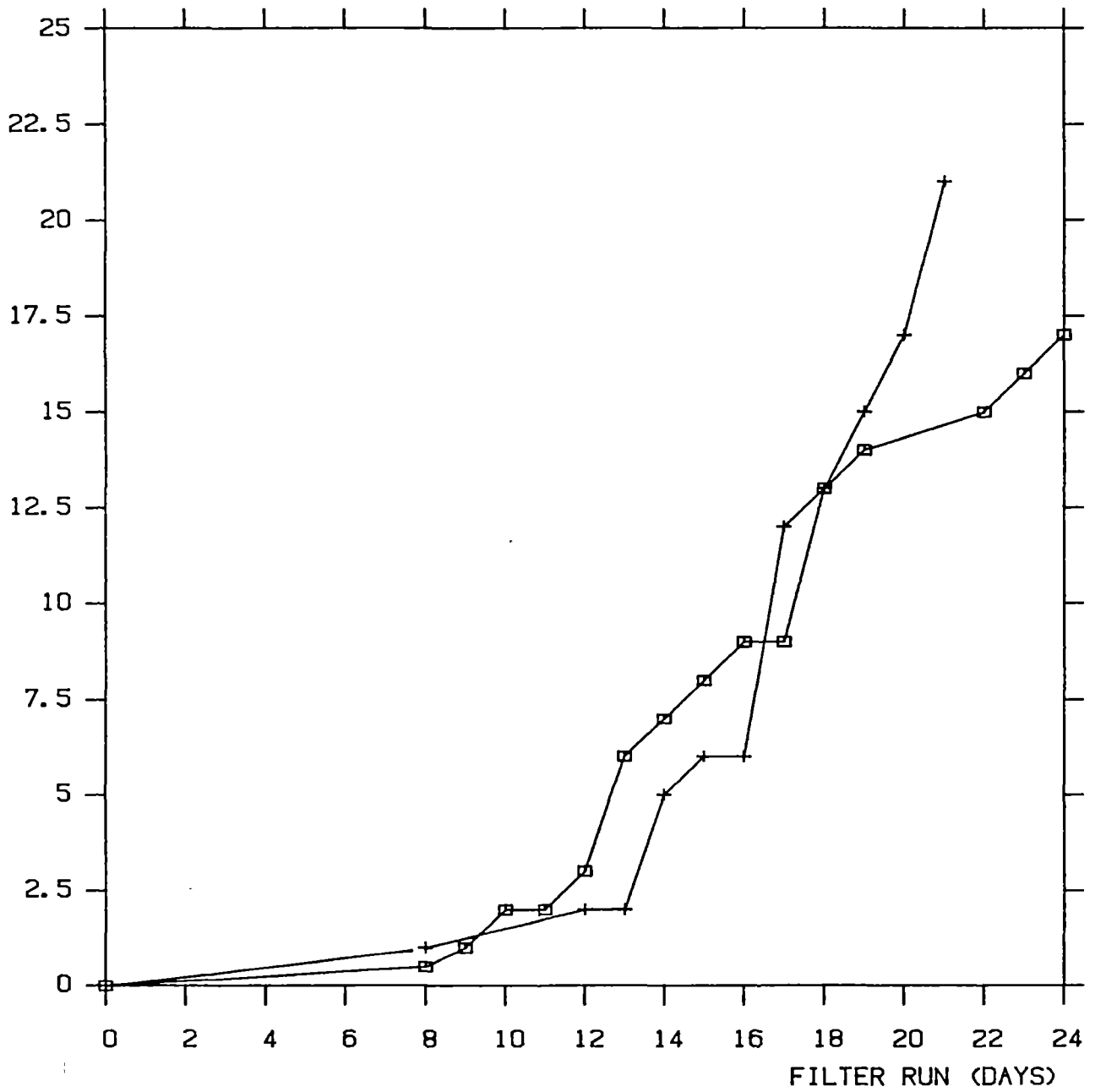

Filter Run :    □  1.6. - 25.6.81  
                   +  14.8. - 4.9.81

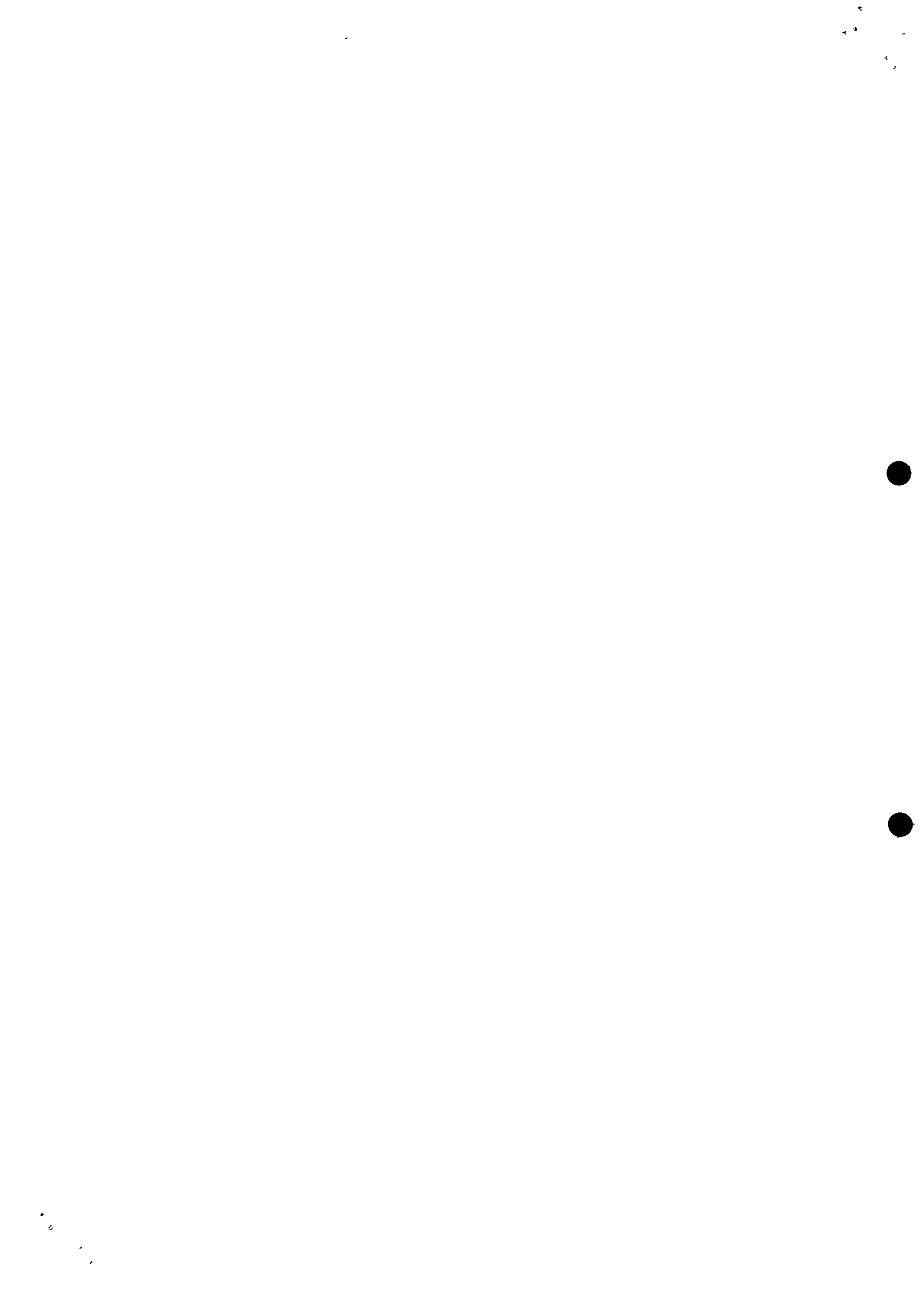

## SUMMARY OF FILTER RESISTANCE DEVELOPMENT FOR DIFFERENT SSF's

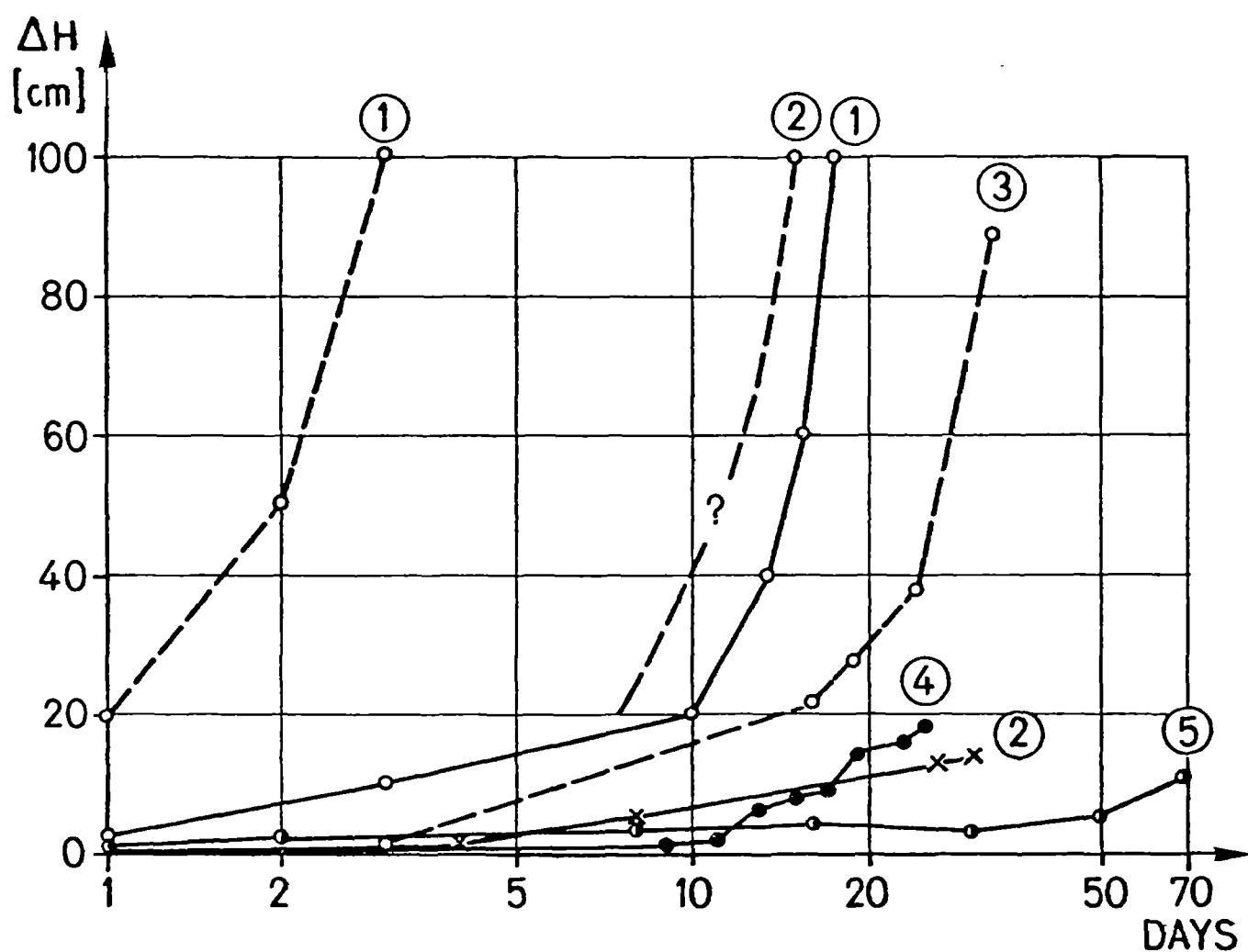

Key: raw water ----- untreated  
 pretreated with HRF —————

- ① Handeni
- ② Wanging'ombe, SSF models
- ③ Wanging'ombe, big SSF
- ④ Iringa, fine sand
- ⑤ Iringa, coarse sand

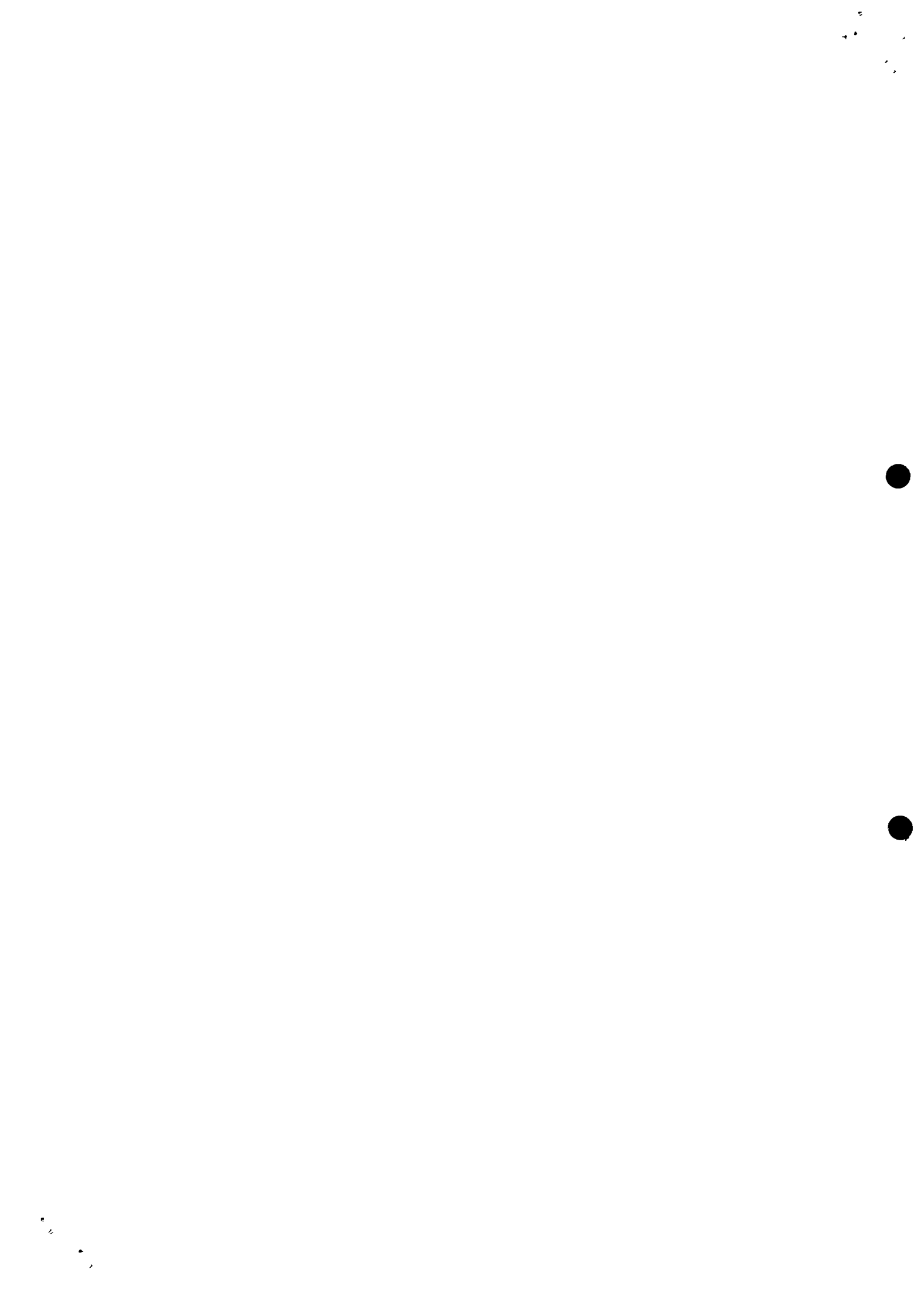

SIEVE ANALYSIS OF USED SAND FOR SSF

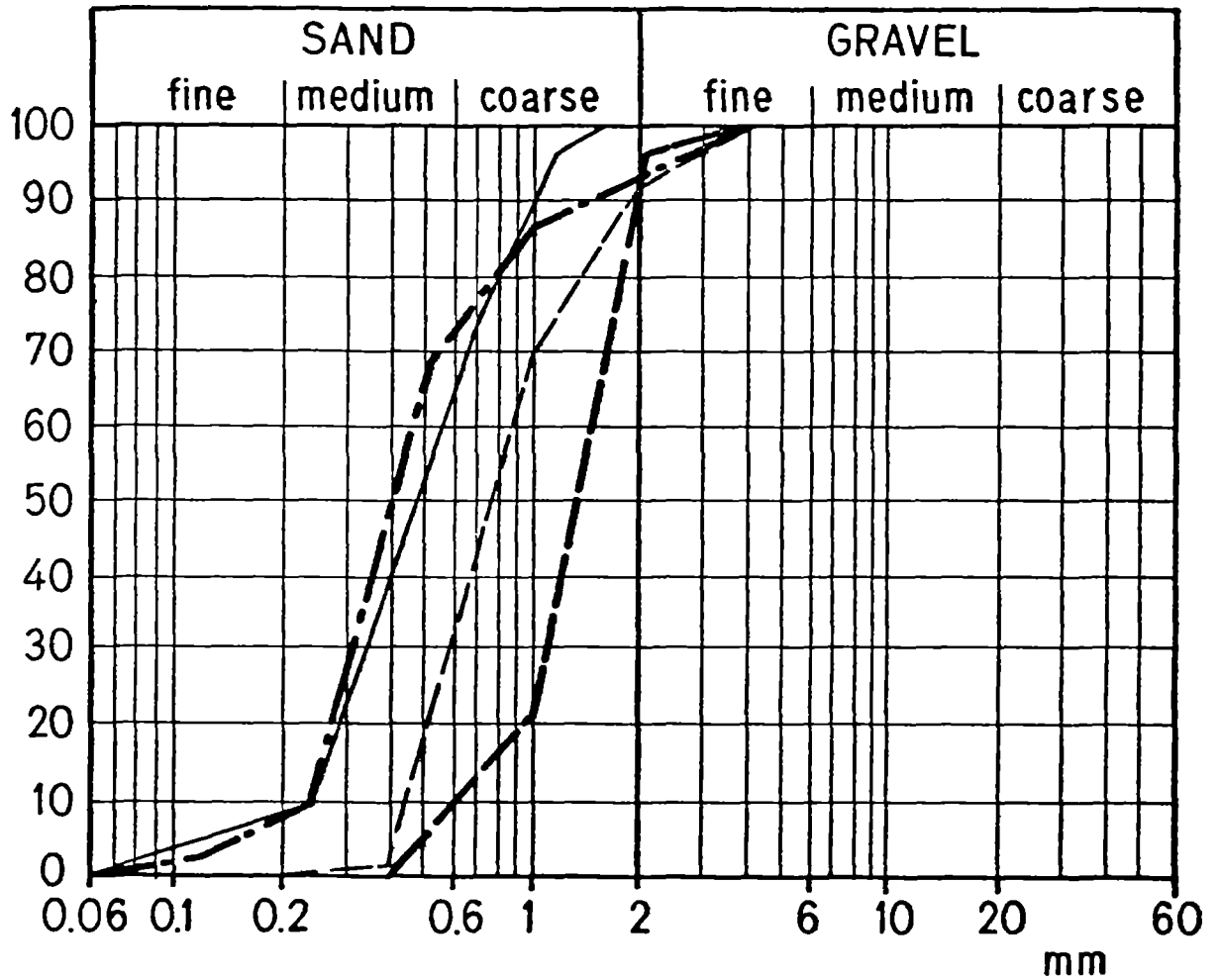

SPECIFICATIONS :				
Graph	Location	$d_s = d_{10}$	$d_{60}$	$U = \frac{d_{60}}{d_{10}}$
————	Handeni	0.24 mm	0.59 mm	2.5
-----	Wanging'ombe	0.44 mm	0.88 mm	2.0
-.-.-.-	Iringa coarse sand	0.62 mm	1.50 mm	2.4
-----	Iringa fine sand	0.23 mm	0.46 mm	2.0

2  
3  
4



5  
6  
7

Provisional Recommendations for the HRF Design

There are two major criteria to be observed during design of HRF:

1. To produce a HRF filtrate which copes with the quality standards for SSF influents (especially with respect to suspended solids)
2. The filter run should be long enough for convenience of plant operation, it should certainly not be less than half a year.

In order to attain the two goals, the following provisional design guidelines should be adopted:

- i) The acceptable range of velocity of filtration is 0.5 - 4.0 m/h but an upper limit of 2.0 m/h should be observed for waters with very high suspended solids load and/or colloids.
- ii) The filter grains to be used should have two to three fractions with sizes ranging from 4 - 40 mm. The sequence of arrangement in longitudinal direction should be from coarse to fine.
- iii) Because the first fraction of the filter bed stores a higher fraction of suspended solids than the others, the length of the coarse fraction zone provided should be greater than that of finer fraction in order to provide a large silt storage volume. Thus, the following range of lengths of individual fraction zone should be provided:
 

first, coarse fraction:	4.5 - 6.0 m
middle, medium fraction:	3.0 - 4.0 m
last, fine fraction:	1.5 - 2.0 m

As a result, we arrive at a total length of filter of 9.0 - 12.0 m.

- iv) For HRF with side walls which are above the ground surface, the height should be below say 1.0 - 1.5 m to allow easy cleaning of the HRF which will involve manual digging out of gravel and refilling it after cleaning.
- v) The free water table in the HRF should be covered by a 10 - 20 cm thick gravel layer in order to prevent plant and algal growth. Hence the top level of the filter medium should be 30 - 40 cm above the crest level of the outlet weir.
- vi) The outlet weir should be provided with a V-notch shaped metal sheet to facilitate discharge measurements.

2  
3



2  
1



## MAIN FEATURES OF A HORIZONTAL - FLOW ROUGHING FILTER (HRF)

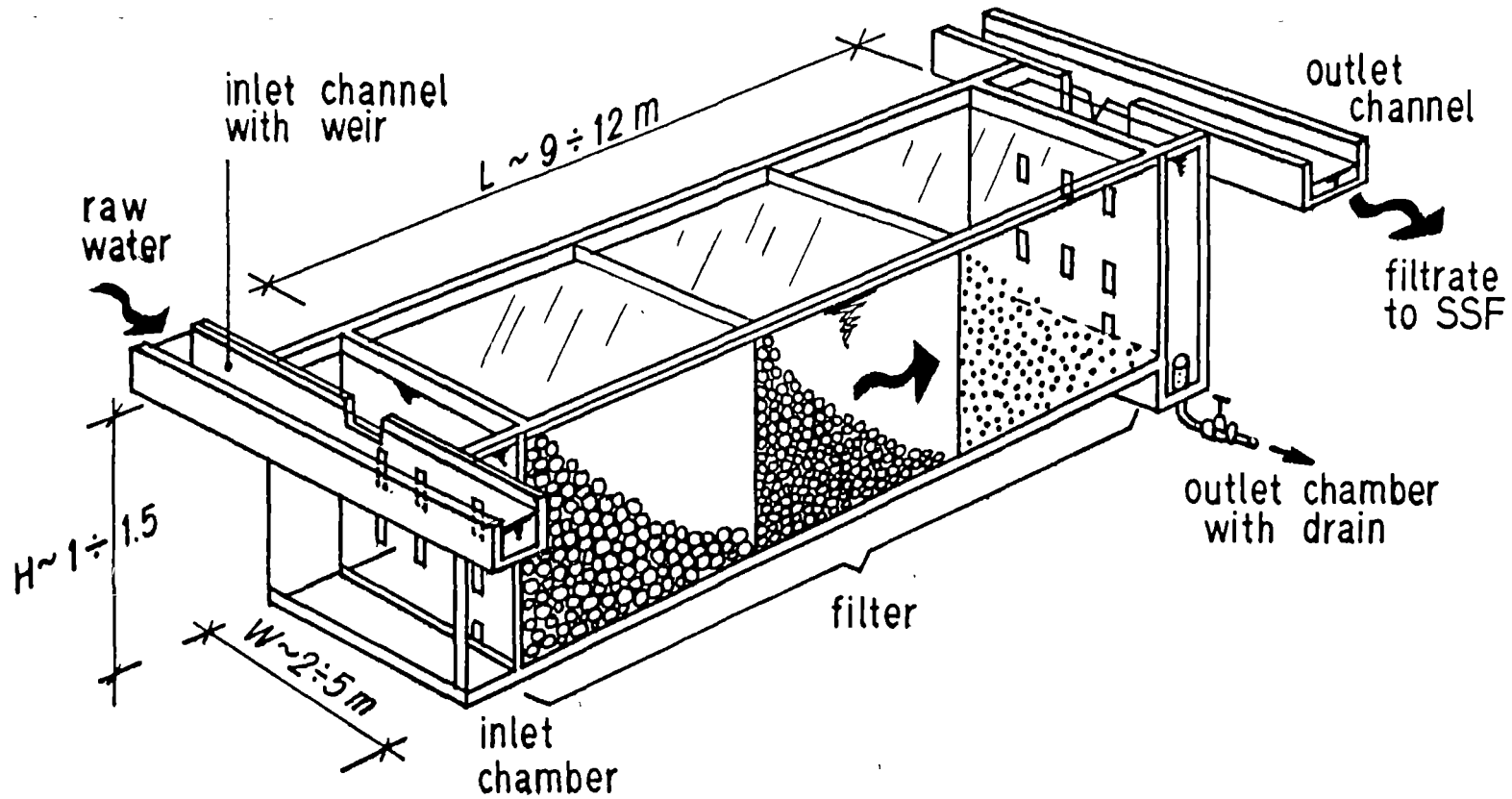

1  
2



3  
4

Planned Research Programme

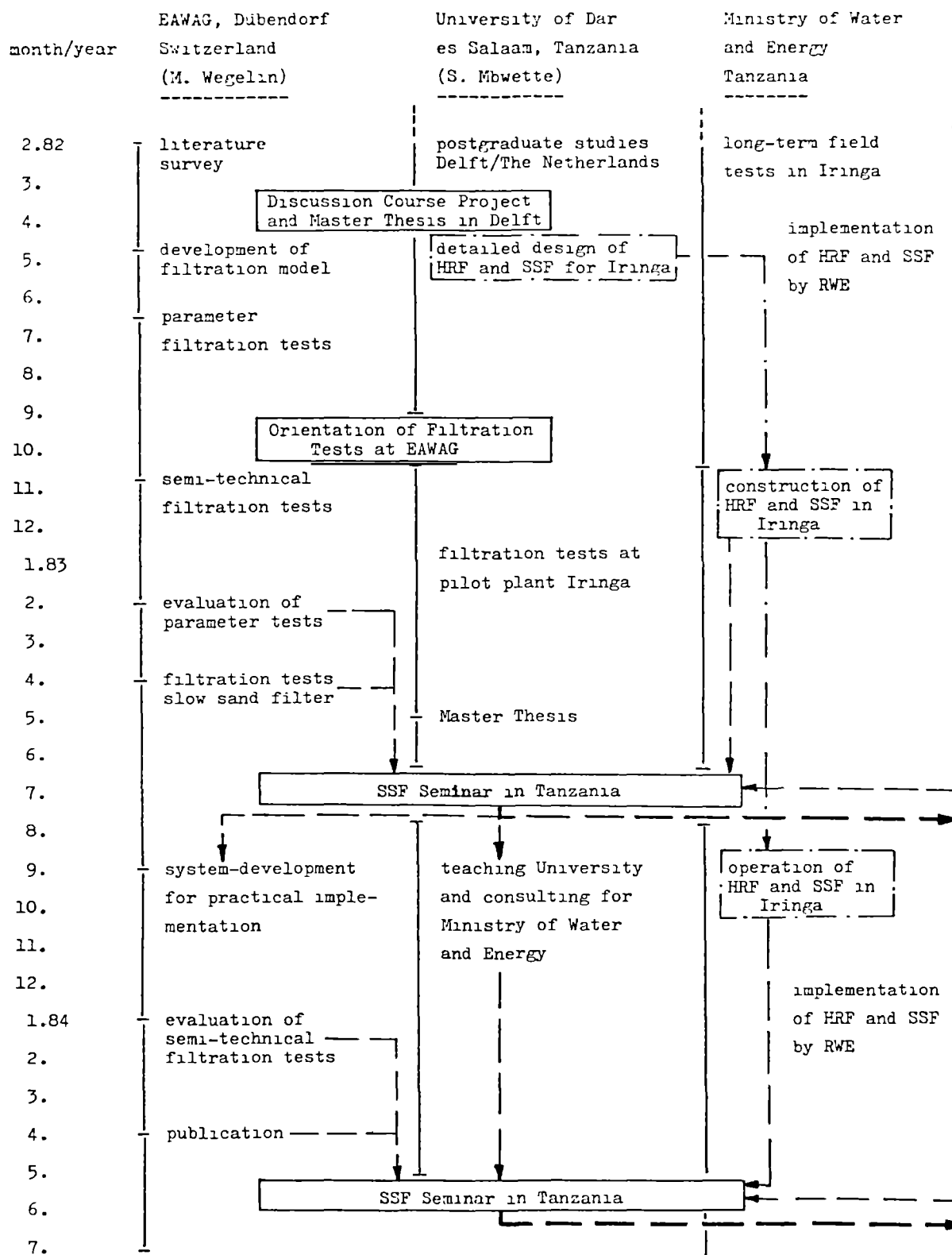

SSF Slow Sani Filter  
 HRF Horizontal-flow Rounging Filter  
 RWE Regional Water Engineer  
 EAWAG Swiser Feferal Institute for Water  
 Resources and Pollution Control

12

1

2

3

4