

3 2 0
8 2 B A

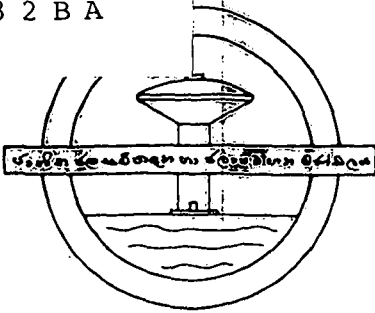

SRI LANKA

1352/23

THE NATIONAL WATER SUPPLY
AND DRAINAGE BOARD

MARKET TOWN WATER SUPPLY
JAFFNA PROJECT

BASIC SANITATION
TRAINING MANUAL
EXCRETA DISPOSAL AND SEWERAGE

LIBRARY
International Reference Centre
for Community Water Supply

AID PROJECT NO. 383-0063

ENGINEERING - SCIENCE
DESIGN · RESEARCH · PLANNING

125 WEST HUNTINGTON DRIVE · P.O. BOX 538 · ARCADIA, CALIFORNIA 91006 · 213 / 445 - 7560

COLOMBO

42/1, HORTON PLACE

JAFFNA

32, KACHCHERI-NALLUR ROAD

ES

320-82BA-1352

320
82 BA

~~XXXXXXXXXX~~

MARKET TOWN WATER SUPPLY - JAFFNA PROJECT

BASIC SANITATION TRAINING MANUAL
EXCRETA DISPOSAL AND SEWERAGE

prepared for

THE NATIONAL WATER SUPPLY
AND DRAINAGE BOARD

LIBRARY, THE NATIONAL WATER SUPPLY
AND DRAINAGE BOARD
141/142, S. W. Hill at 141/142
COLOMBO 7, SRI LANKA
ISBN 1352
LC: 320 82 BA

September 1982

LIBRARY
International Reference Centre
for Community Water Supply

prepared by

ENGINEERING-SCIENCE
42/1 Horton Place, Colombo 7.
32, Kachcheri-Nallur Road, Jaffna.

TABLE OF CONTENTS

	<u>Page No:</u>
Objectives	1
Health and Nuisance of Excreta Disposal	1
Alternative Systems	2
Precautions	5
Definitions	5
Disposal of "Septage"	6
Raised Units	6
Dual Systems	6
Privy Vaults	6
Liquid Waste Disposal	9
Definitions	9
Septic Tank System for Modern Water-Flush Plumbing	11
Cleaning of Septic Tanks	11
Percolation Tests	13
Determining Size of Absorption Systems	18
Seepage Pits	19
Special Precautions	24
Special Type Soil Absorption Systems	24
Other Design Factors	25
Summary of System Design	26
Absorption System	27
Disadvantages of Activated Sludge Systems	28
Conventional Public Sewers and Sewage Disposal	30
Special Sewers	30
Public Sewage Disposal	30
Septic Tanks	30
Stabilization Ponds	31
Conservancy Systems	33
Underground Travel of Contamination	36
Direction of Travel	36
Filtration In Soils	36
Conclusions - For Granular Soils	37

TABLE OF CONTENTS (CONTD.)

	Page No:
Contamination Travel In Rock	37
Soil and Groundwater Investigations	38
Volumes of Excreta From Pour-Flush Systems	39
Aqua Privy	39
Special Studies of Soil And Geology	40
Test Holes	41
Other Observations	41

LIST OF FIGURES

	<u>Page No.</u>
1. Vacuum Tanker	3
2. Septic Tank for Pour Flush Latrine	4
3. Soakage System For Pour Flush System	7
4. Jaffna CPHI Double Vault	8
5. Typical Two Compartment Septic Tank	12
6. Procedures For Making Percolation Test	14
7. Percolation Test Procedures	16
8. Chart For Determining Square Feet of Absorption of Area	17
9. Seepage Pit	20
10. Seepage Pits in Fine Soil	21
11. Seepage Pit	22
12. Seepage of Soakage Trench or Bed	23
13. Aerobic System	29
14. Stabilization Pond Design	32

BASIC SANITATION TRAINING MANUAL

EXCRETA DISPOSAL AND SEWERAGE

OBJECTIVES

The Project is intended to provide plans, advice and training in both water supplies and sanitation (excreta and sewage disposal).

The Introductory Training Manual provides information on the total Project and covers the public health aspects of both the water supplies and sanitation.

The Water Supply Manual is intended for water system managers, supervisors, designers, operators and surveillance personnel.

This Basic Sanitation Manual is intended to provide guidance for planning, designing, building and maintaining the various systems for excreta and sewage disposal.

The manuals will be supplemented by classroom, laboratory and field training programs.

HEALTH AND NUISANCE ASPECTS OF EXCRETA DISPOSAL

The Introductory Training Manual covers the health aspects of excreta disposal. The problems include:

1. Pathogens from excreta and sewage entering the limestone and travelling considerable distances to contaminate public and private drinking water supplies.

2. Intestinal parasites from excreta contaminating the soil and surfaces and resulting in excessive cases of hook, round, whip and other intestinal worms.
(Intestinal parasites).
3. Fly transmission of pathogens from exposed excreta to food.
4. Sea and beach contamination by defecation (excreta) which contaminates sea foods.
5. Odor nuisances and unsightly conditions.

ALTERNATIVE SYSTEMS

Conservancy System - The bucket system is the best presently available system for excreta collection, transportation and disposal for homes and businesses where there is not room and suitable conditions for pour-flush latrines.

This Manual suggests improvements for this system.

It is strongly recommended that the Conservancy System not be abandoned until a suitable substitute system is available.

Pour-Flush (water-seal) Latrine - The W.H.O. publication on Excreta Disposal, written in 1958, credited Ceylon with having pioneered in this system 25 years before the book was written. Field training for masons and carpenters will cover certain basic principles. Some of those are illustrated in the following drawings from the Introductory Training Manual.

The Vacuum Tanker, which is proposed to help improve the Conservancy System operations, would be very useful for emptying the vaults of pour-flush toilets (Figure 1). The Consultant reviewed the program in Bangkok where 100 such trucks are

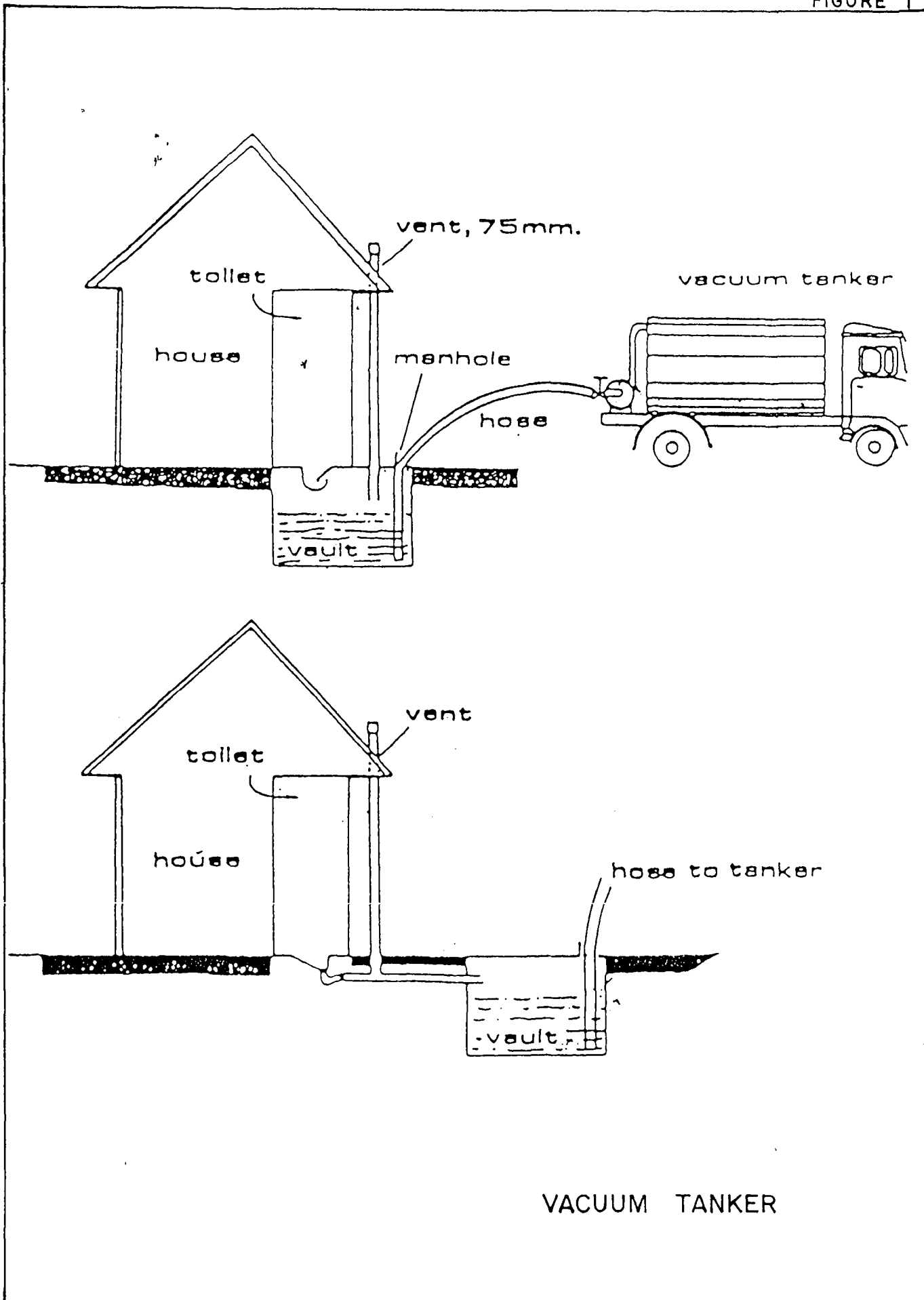

VACUUM TANKER

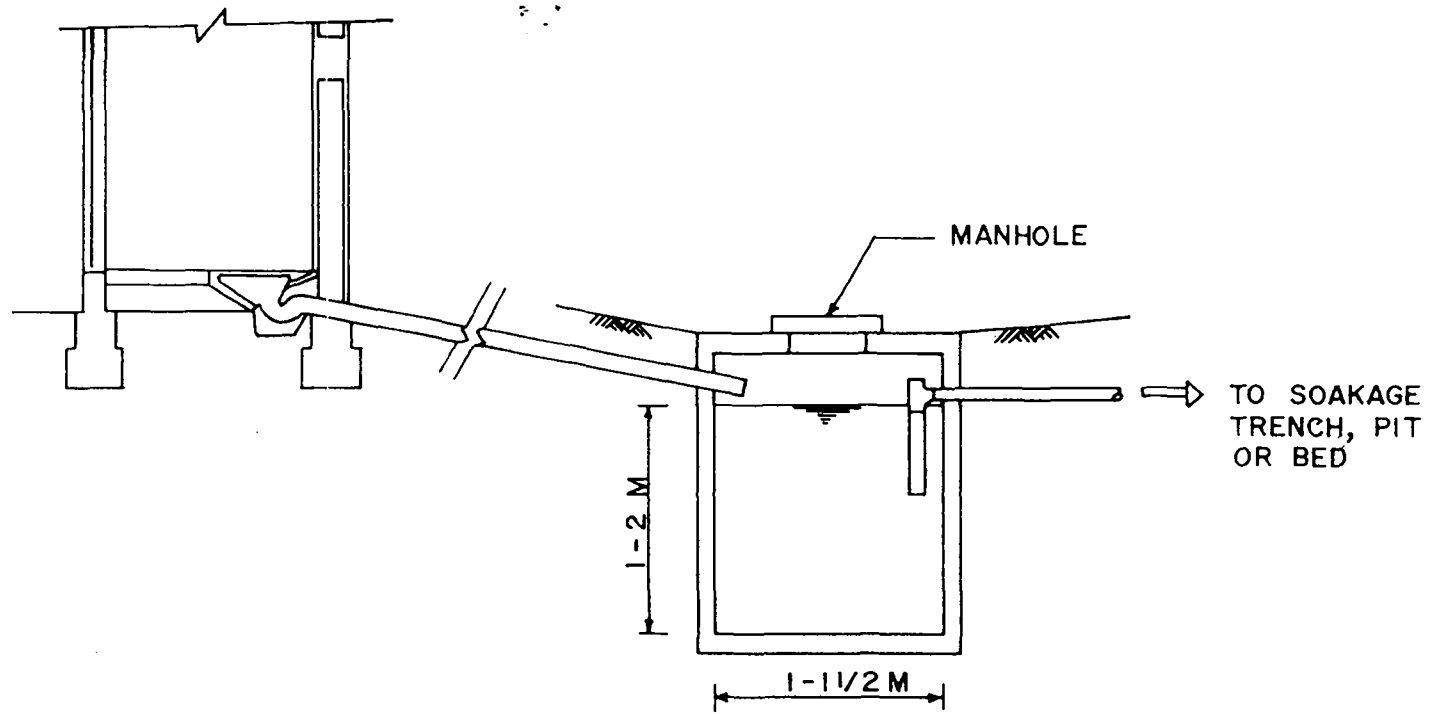

SEPTIC TANK FOR POUR FLUSH LATRINE

used to pump out such vaults, as well as septic tanks.

PRECAUTIONS

The precautions covered below under septic tank "Absorption Systems" also apply to pour-flush and water-sealed latrines. These include precautions against drainage of fecal material and liquids into limestone.

DEFINITIONS

Privy - A hole in the ground to directly receive human wastes. There are new modern privies designed to reduce odors called VIP (Ventilated Improved Privy).

Bored hole latrine - A simple, but not fully satisfactory, 12 to 20 inch diameter hole, 10 or more feet deep, used as a privy.

pour-flush (water-sealed) Latrine - A squat-plate type toilet with a "u-shaped" trap which prevents escape of odors from the pit, vault or septic tank (See Figure 2).

Pit Privy - Four or more feet deep and three feet square or larger with seat or step plates. Seat with hinged, self-closing cover to keep pit fly-tight.

Aqua privy - Usually a concrete tank about three feet square and three feet deep, water tight, with overflow near top, with liquid draining to seepage pit or sewer. Designed with tube from underside of floor to beneath water level to confine air above liquid (odor control). Flush with a few liters of water per day (popular in some new villages in countries like Kenya).

DISPOSAL OF "SEPTAGE"

The mixture of excreta and water from a pour-flush latrine vault or a septic tank should either be buried where it will not contaminate groundwater; or should be plowed under on land which will not soon be used for vegetable crops.

RAISED UNITS

Note the following sketch (Figure 3) which indicates how to raise the squat-plate and latrine floor high enough to permit making a 20 to 24 inch sand fill below the drain system, if in an area of shallow soil cover over limestone or high groundwater.

DUAL SYSTEM

The illustration of a system with a dual vault (Figure 4) and a "diversion box" is important. When one vault fills, the flow can be diverted to the other. Then, in the usual many months until the second vault fills, the material in the first vault can drain (if in somewhat porous soil) and become dry and "digested" to make it less odorous and easier to remove than the wet mixture of water and excreta.

PRIVY VAULTS

For some families it may be a burden to carry enough extra water from a distant standpost or well, to flush the latrine. They may wish to consider a simple pit privy.

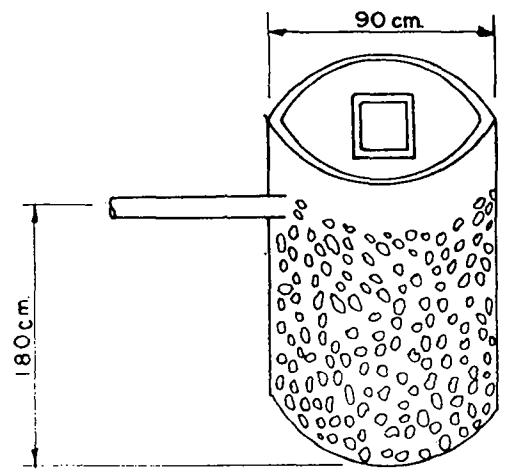

SEEPAGE PIT

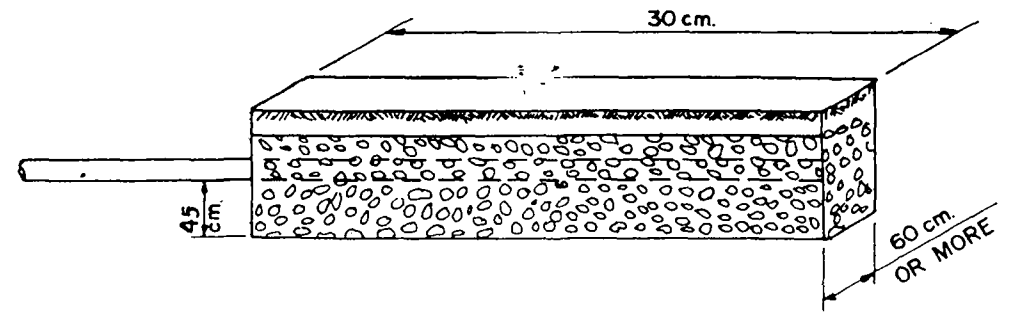

GRAVEL FILLED TRENCH OR BED

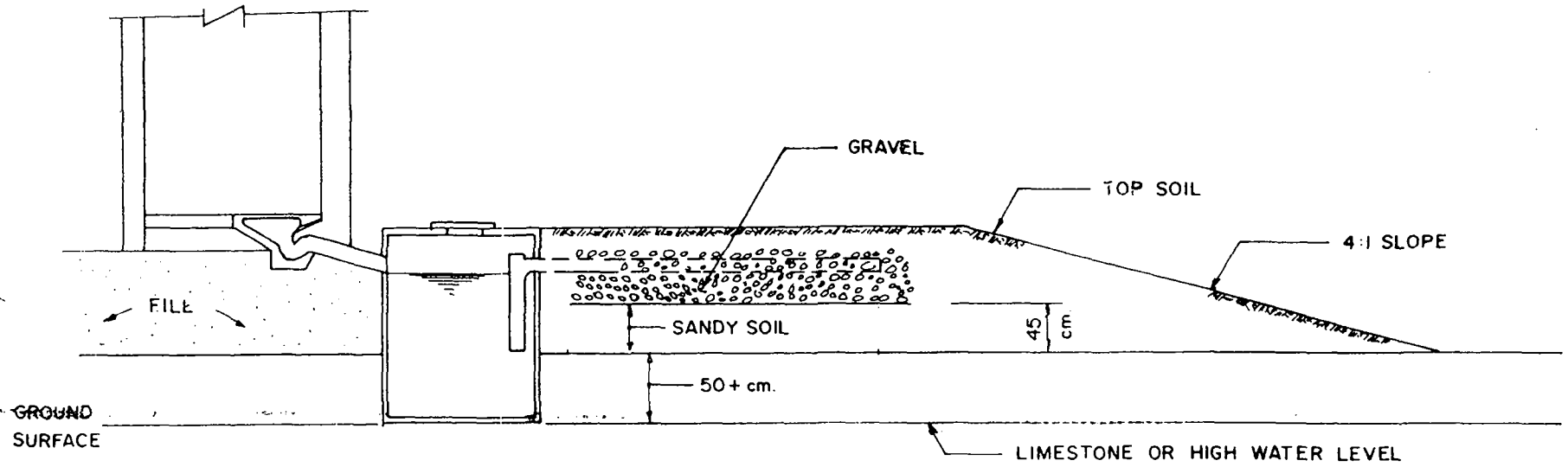

MOUND SYSTEM

SOAKAGE SYSTEM FOR POUR FLUSH SYSTEM

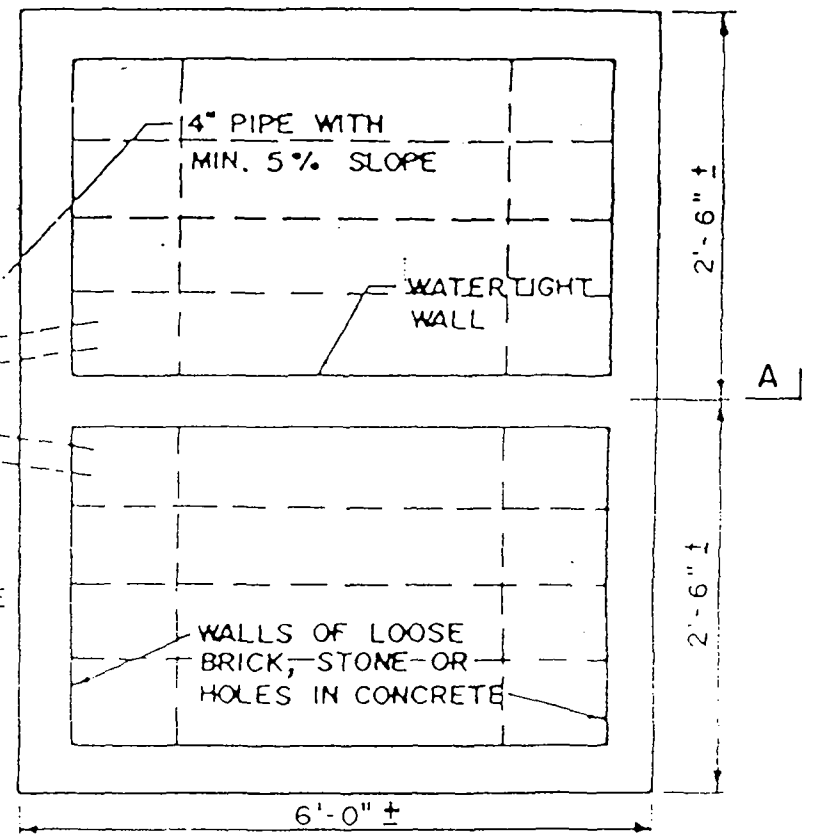
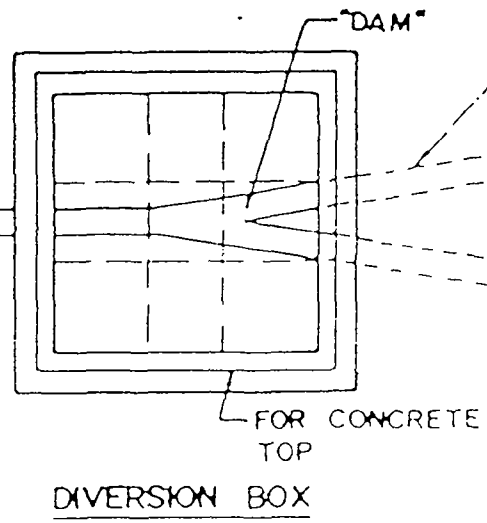
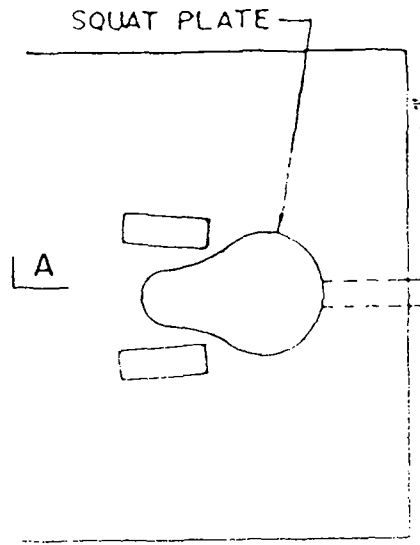

TOP VIEW

DOUBLE SOAKAGE PIT

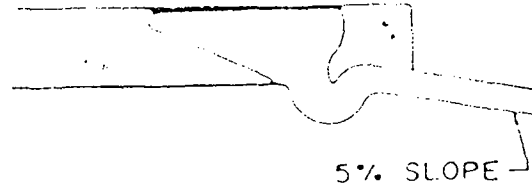

SECTION A-A

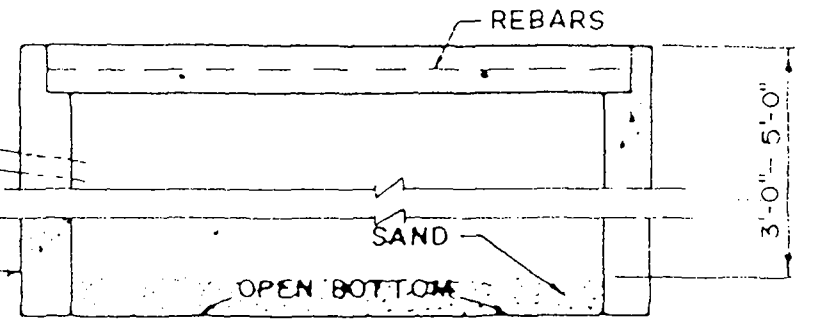
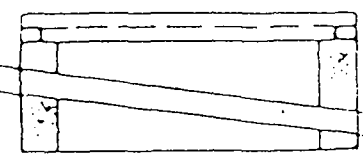

JAFFNA CPHI DOUBLE VAULT

NOTE : 1. ONE VAULT DRIES WHILE OTHER FILLS
 2. DRIED VAULT IS THEN DUG OUT.

FIGURE 4

LIQUID WASTE DISPOSAL

DEFINITIONS

Sewage

Liquid waste which contains human excrement

Sewer

Pipe for conveying sewage within a building.

Sewerage

System of sewers and appurtenances for conveying and treating sewage.

Septic Tank

Water-tight chamber for retaining sewage to allow solids to separate and in which digestion of organic solids may take place.

Cesspool

Hole in ground with open bottom and porous sides for receiving raw sewage.

Seepage Pit

Hole, as cesspool, but for receiving effluent from septic tank or other treatment device.

Detention Period

Time, usually hours, theoretically required for liquid to flow through tank or system (volume divided by gallons per hour).

d.o.

Dissolved oxygen, p.p.m. or mg/l.

b.o.d

Biochemical Oxygen Demand, parts per million or mg/l of

dissolved oxygen depleting characteristics of a waste, to determine probable effect on dissolved oxygen content of receiving water.

Septic

(Applied to waste or water) devoid of D.O. due to organic decomposition and usually accompanied by odor and grey or black color.

Primary Treatment

Usually a detention tank plus sometimes screen, grit removal chamber (detritor), and intended for reduction of suspended material in waste, usually with detention period of one hour.

Secondary Treatment

Process following primary treatment to stabilize waste, usually by biological action in an aerobic environment.

Soakage Pit

A hole, sometimes filled with stones, used for seeping sullage water into the soil.

Tertiary Treatment

Beyond secondary treatment such as to remove phosphates, further stabilize, filter, etc.

Sludge (in sewage)

Liquid or semi-liquid concentration of material removed from sewage or industrial waste.

SEPTIC TANK SYSTEM FOR MODERN WATER-FLUSH PLUMBING

Cesspools are not recommended because grease and solids from sewage tend to plug the pores in the soil. To help prevent such plugging, septic tanks are used to provide an opportunity for the sewage to be retained for about 24 hours so heavier-than-water material will sink and light material float while the relatively clear water between flows to the subsurface absorption (liquid disposal) system.

Septic tanks are usually of concrete and hold 700 to 1,000 gallons for the average home. The top is arranged to be removable or with manhole openings so sludge may be removed every few years or more often. The solids tend to digest, to reduce their volume by about 50 per cent. Many codes require the tanks to have two compartments; the first being 2/3 and the second 1/3 of the tank volume (See Figure 5).

The effluent contains dissolved organic material, has a typical sewage-type odor and may contain pathogens. It must usually be disposed of by absorption beneath the ground surface in a seepage pit or a disposal bed or trench. If possible, the liquid should not flow into streams, lakes, the ocean, nor into open street-side drains (odor problems). The size, design and location of the subsurface liquid absorption system depends upon soil and groundwater conditions.

CLEANING OF SEPTIC TANKS

Septic tanks partially digest organic solids and grease

TYPICAL TWO COMPARTMENT SEPTIC TANK

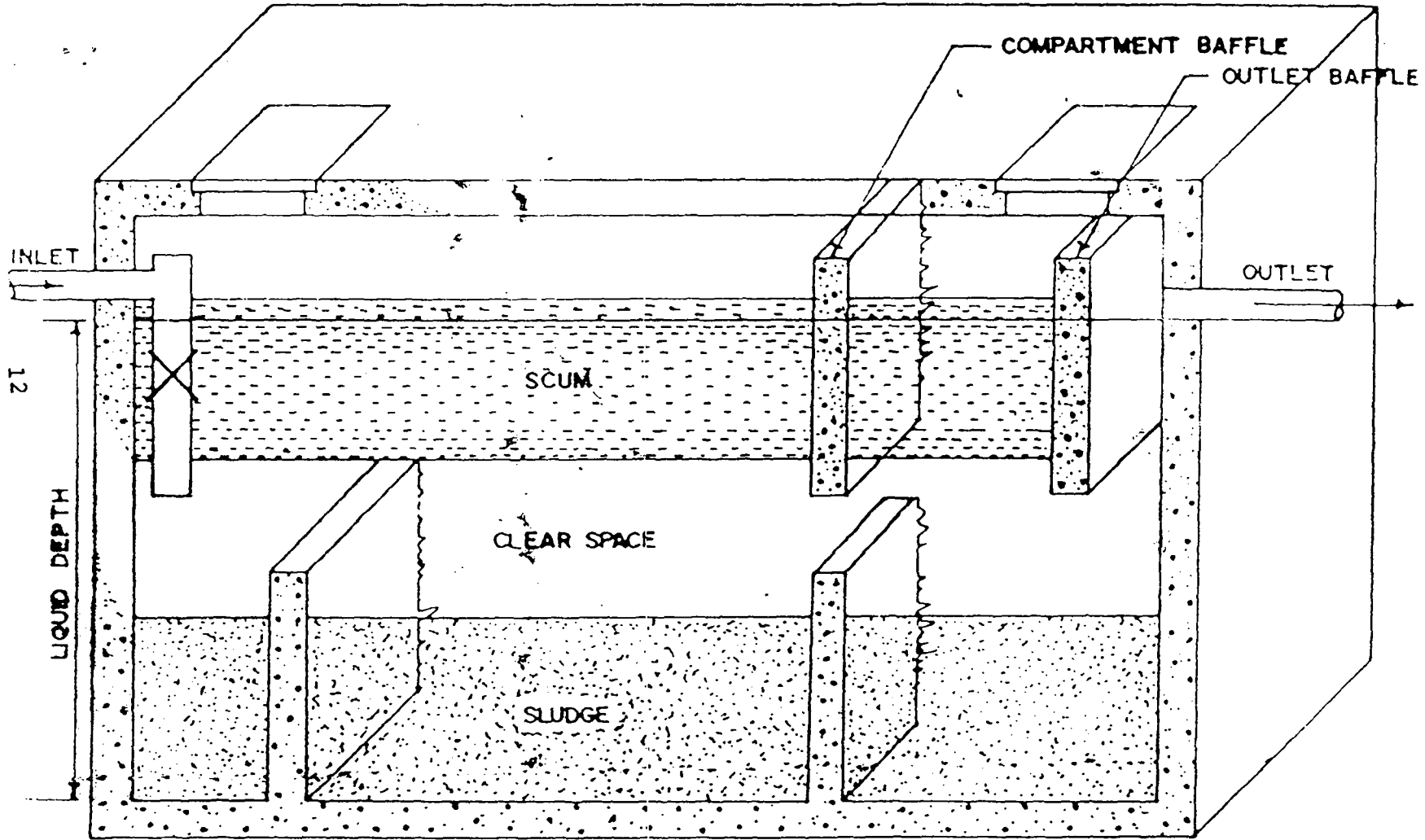

FIGURE 5

but do eventually fill to the point where solids pass through the outlet. The frequency of cleaning depends upon the tank size and the number of persons using the system; therefore, the usual frequency varies from once in one year to once in five years.

Both the floating scum and the settled solids must be removed so it is usually necessary to mix solids and liquid and empty the tank. The removed solids (septage) can be spread and plowed into land not used for vegetables.

PERCOLATION TESTS

Soil examination in special test holes is usually necessary to determine the soil "percolation" suitability. The test holes also show depth to rock formations and groundwater. "Percolate" means to slowly seep through.

To obtain additional data on soil porosity, percolation tests are made at the location and depth where the sewage disposal system would be installed. The test is conducted to provide a rate at which water seeps into the soil, and is measured as the number of minutes required for the water level in the test hole to drop one inch.

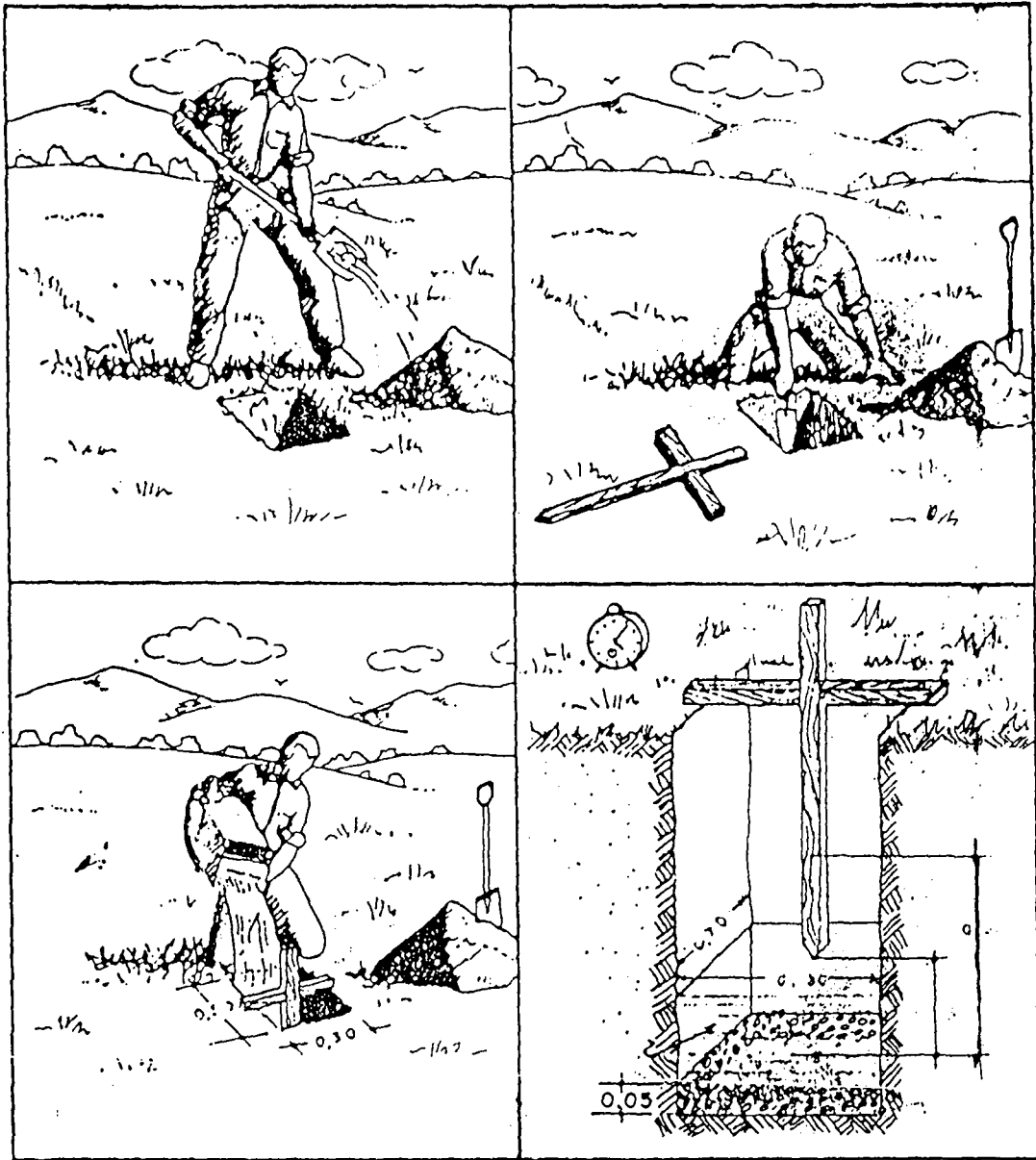

PROCEDURES FOR MAKING PERCOLATION TESTS

The hole is dug with a diameter of 6 to 12 inches. Two inches of small stones are placed at the bottom. The hole walls are "scarified" (scraped to roughen surface) if the soil contains clay. If soil is so sandy the walls cave, no test is necessary and the rate is less than 10 minutes per inch.

It is usually necessary to soak the soil before recording the timing of the rate of percolation. This can be done by soaking for a few hours by keeping the hole at least partly filled. Then the rate is timed until it becomes quite constant (in minutes per inch of drop of water level).

The test is usually finally made by filling the hole to about 12 inches deep above the 2 inches of stones in the bottom. Time is recorded each 10 to 30 minutes until the hole is nearly empty. Results are averaged to give the rate in "minutes per inch". If the rate is over 60 minutes per inch the soil is usually classed as "unsuitable". It may be somewhat acceptable for liquid from pour flush latrines, at rates up to 120 minutes per inch (See Figure 6). Typical.

The "minutes-per-inch" obtained from the above "average" is used in connection with Figure to find the number of "square feet of absorption area required. That means any of the following:

1. Square feet of trench bottom.
2. Add 50% to get square feet of seepage bed bottom areas.
3. Square feet of side-well area of seepage pit, below level of inlet.

PERCOLATION TEST PROCEDURES

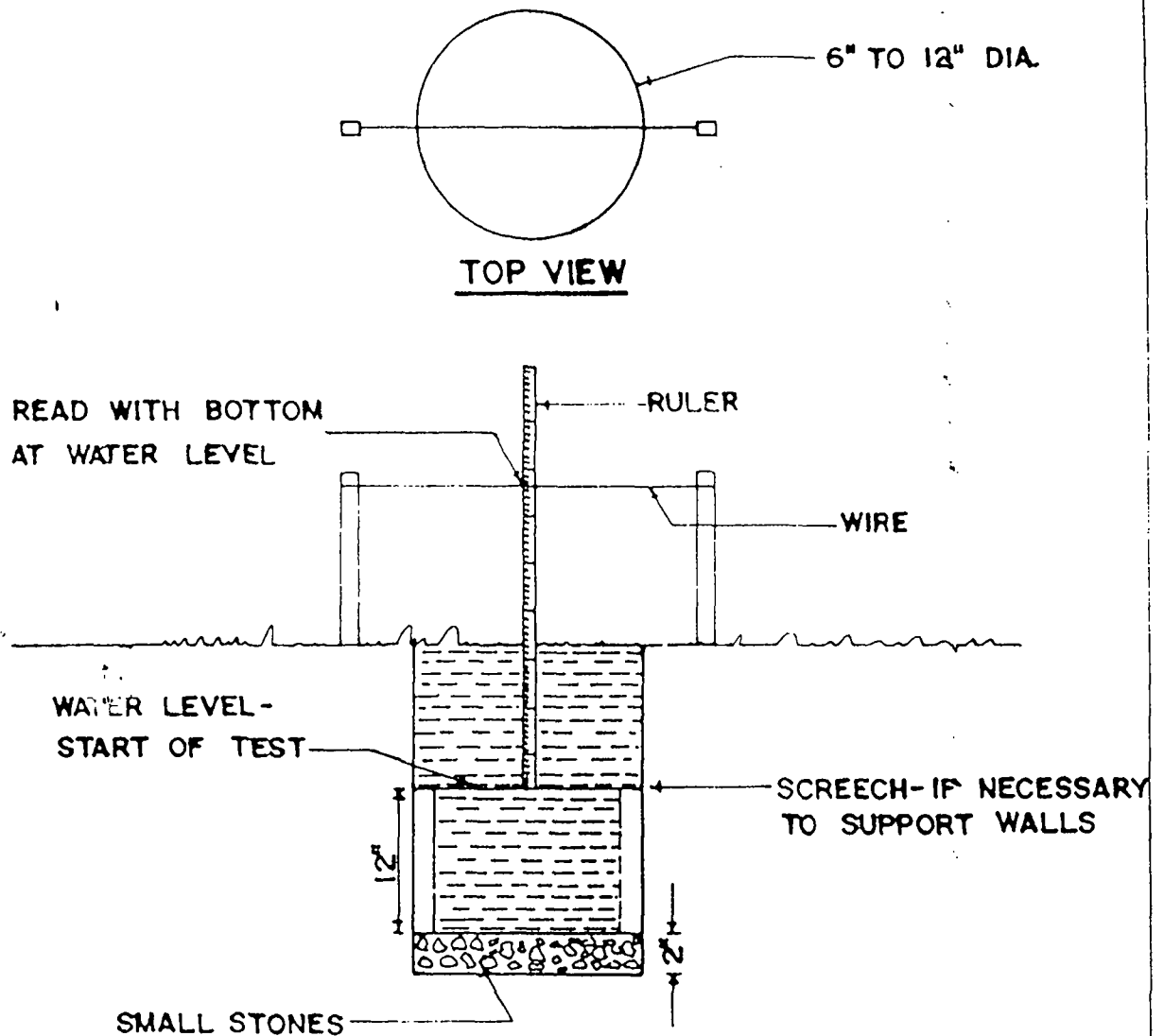

BOTTOM OF TEST HOLE TO BE AT ELEVATION OF PROPOSED SEEPAGE SYSTEM BOTTOM

TEST PROCEDURES

1. ROUGHEN WALLS OF HOLE AFTER EXCAVATION.
2. FILL AND REFILL TO ALLOW HOLE TO SOAK THOROUGHLY.
3. READ RULER EACH 10 TO 30 MINUTES.
4. CONTINUE TEST UNTILL WATER LEVEL IS ONE INCH ABOVE ROCK.
5. AVERAGE READING RESULTS TO GET "AVERAGE" MINUTES FOR WATER LEVEL TO FALL ONE INCH.
6. USE CHART (FIG.____) TO FIND REQUIRED SIZE OF PERCOLATION AREA IN SQ.FT.

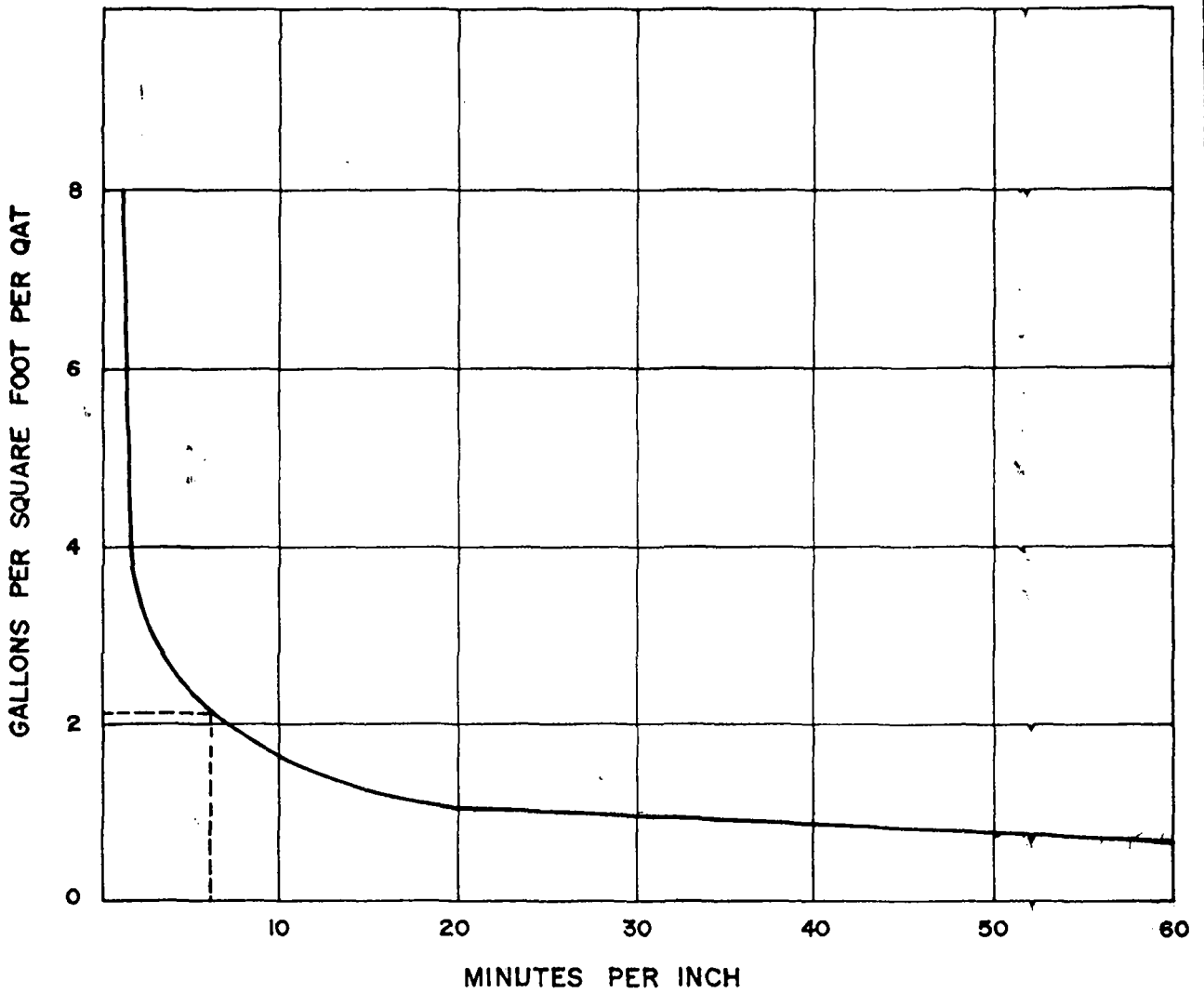

CHART FOR DETERMINING SQUARE FEET
OF ABSORPTION AREA

DETERMINING SIZE OF ABSORPTION SYSTEMS

Pits

Assume percolation test indicates 150 square feet of seepage area is required.

Assume pit will be 5 feet in diameter.

How deep must pit be?

$$\text{Area (A)} = \pi D^2 H$$

$$H = \frac{A}{\pi D^2} = \frac{150}{3.1416 \times 5^2} = \frac{150}{78.5} = 1.91 \text{ feet} \approx 2 \text{ feet deep.}$$

Trenches

For above example, assume 2 foot wide trenches will be used. How many lineal feet of trenches are required?

$$\text{Area (A)} = L \times W$$

$$L = \text{Length}$$

$$W = \text{Width}$$

$$200 = L \times 2$$

$$L = 100 \text{ lineal feet}$$

Recommend distribution box or arrangement and two lines, each 50 feet long.

Seepage Bed

Assume beds require 50% extra square feet of seepage area. Area of bed = area of bottom.

$$\text{Area (A)} = L \times W$$

Assume bed is 10 feet wide.

$$A = 200 + 50\% = 300 \text{ square feet}$$

$$300 = L \times 10$$

$$L = \frac{300}{10} = 30 \text{ feet}$$

The Seepage Test indicates the following number of square feet:

1. For trenches -trench bottom.
2. For seepage pits - side wall area.
3. Seepage beds - bed bottom.

SEEPAGE PITS

Where there is 15 or more feet of porous soil above ground-water or rock formations, seepage pits may be used. The required size is based upon the "side wall area", as determined by the seepage pit.

If pit is round, the area is $D \times H \times \pi$, where:

D = Diameter

$\pi = 3.1416$

H = Depth below inlet

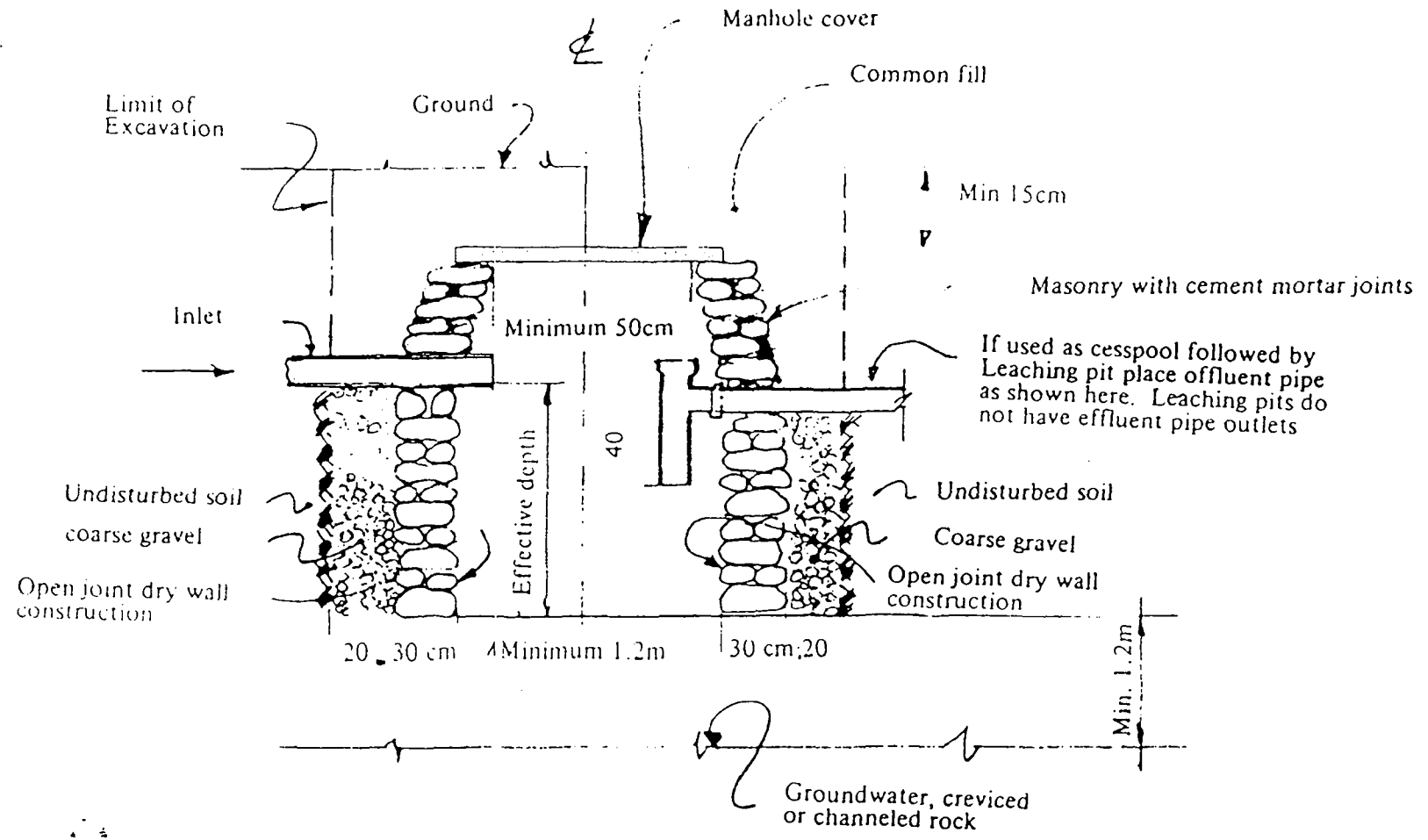

SEEPAGE PIT

SEEPAGE PITS IN FINE SOIL

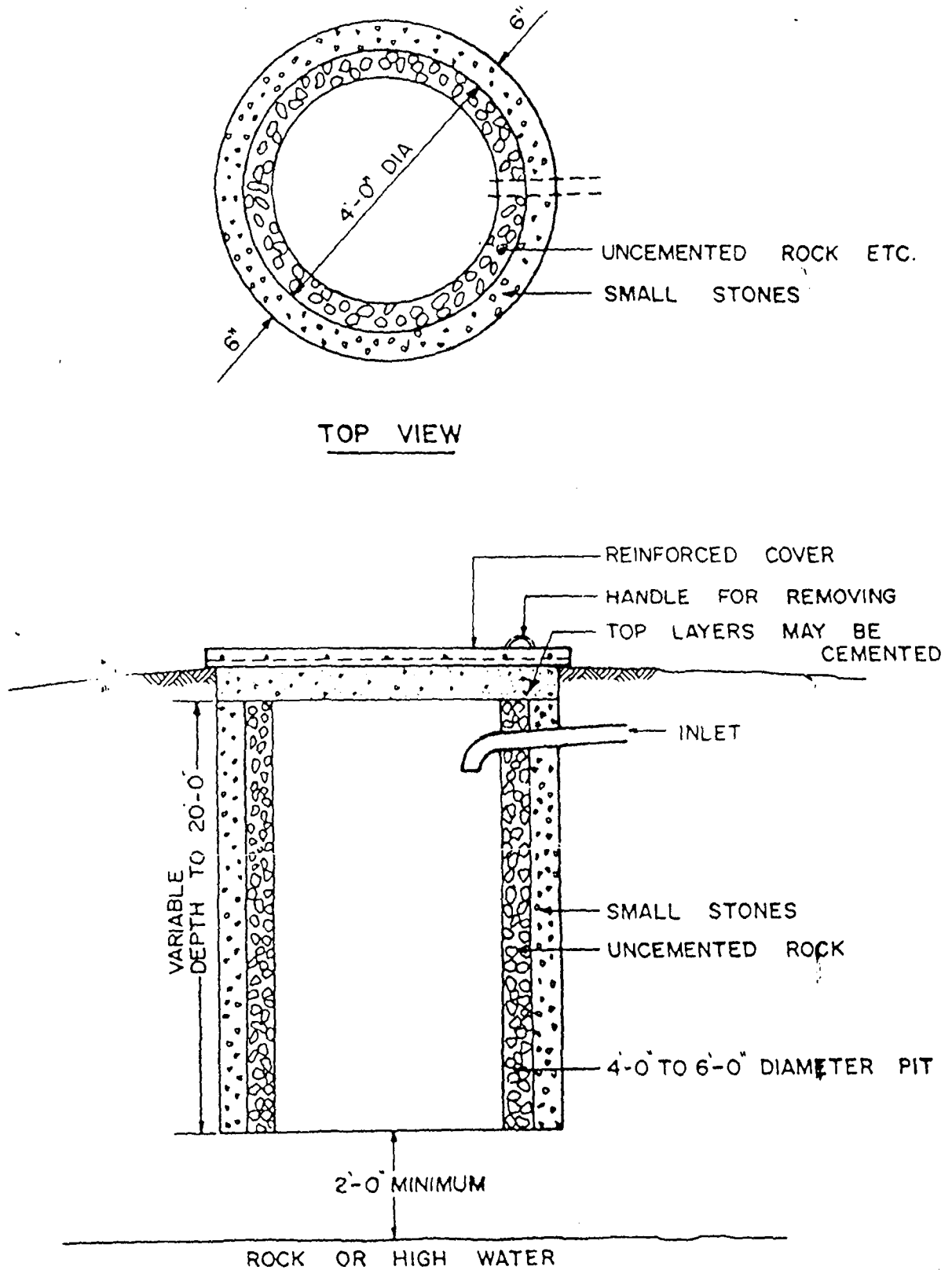

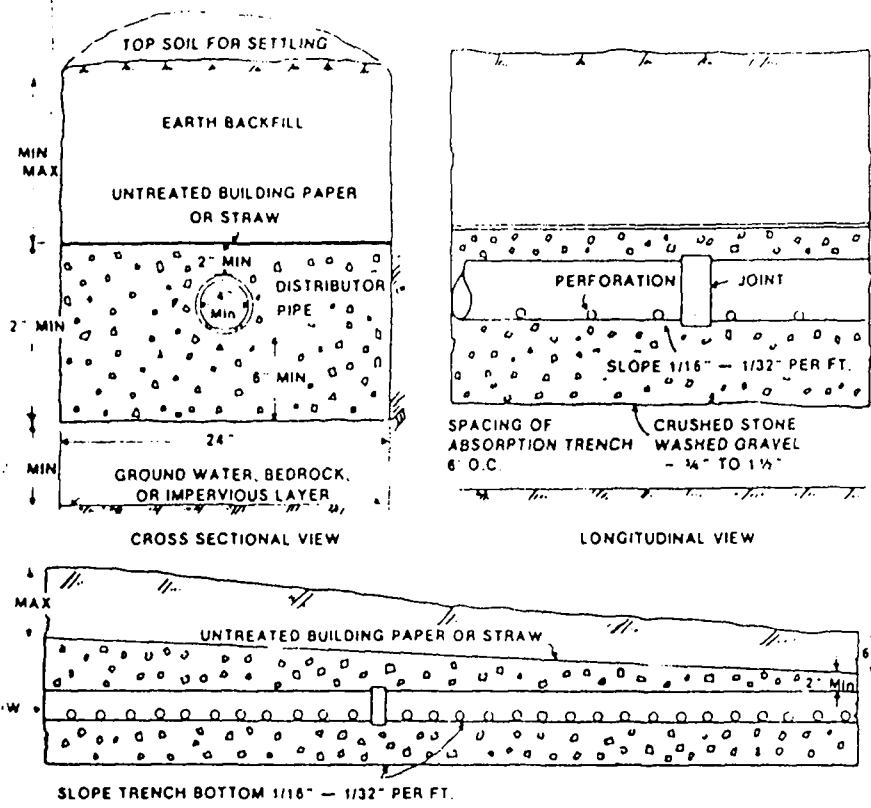

TRENCHES FOR ABSORPTION FIELD

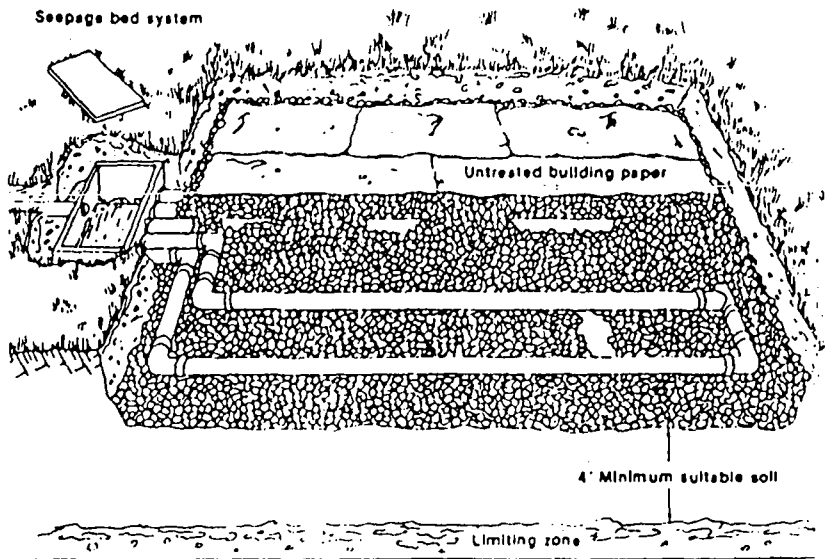

A seepage bed makes more efficient use of the space available for effluent disposal on a small lot

SEEPAGE PIT

SEEPAGE OR SOAKAGE TRENCH OR BED

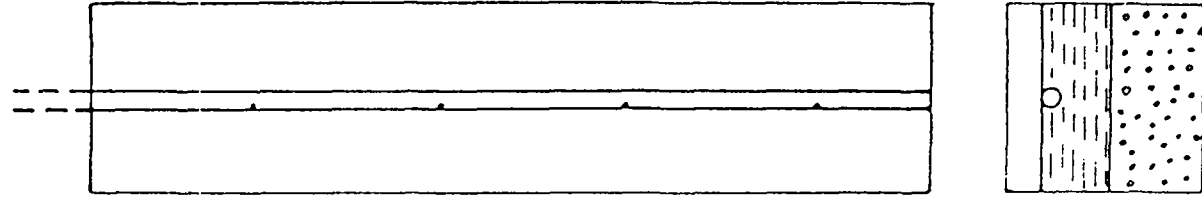

TOP VIEW

END VIEW

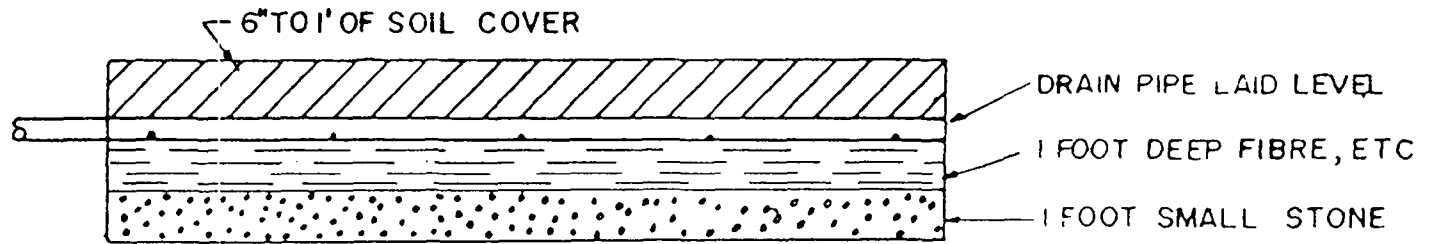

SIDE VIEW

SPECIAL PRECAUTIONS

1. Do not place any part of a seepage pit below normal high ground water level.
2. Keep bottom at least two feet above rock formations. This is especially important in limestone type areas. (See following illustrations of sand filter beds between the seepage system bottom and limestone)
3. Try to avoid installing systems where percolation rate exceeds 60 minutes per inch.
4. Avoid installation of trenches in rainy weather, because wet conditions tend to "smear" soils so they are less absorptive.

SPECIAL TYPE SOIL ABSORPTION SYSTEMS

SHALLOW DEPTH SOIL OVER POROUS LIMESTONE OR GROUNDWATER

In all cases effort should be made to be sure sewage or drainage from pour-flush latrine vaults must seep through at least 20 to 24 inches of soil of fine sand before entering the limestone. See following sketch.

If necessary, elevate toilet to enable placing the sand above the limestone or water table and below the drain. Elevated systems should be considered where seasonal high groundwater table would be less than two feet below the bottom of the disposal system.

LIBRARY
International Reference Centre
for Community Health

OTHER DESIGN FACTORS

1. Grade of Bed and Lines - Trench bottom or beds should be approximately level.
2. Depth of Gravel - The MSTP requirement of a total of 12 inches of gravel for a conventional bed, with 6 inches below the distributing pipe appears to be reasonable.
3. Depth of Bed - An 18 or 20 inch deep bed and 6 to 8 inch deep soil cover is a practical minimum.
4. Spacing of Distribution Lines - Spacing for distribution lines in seepage beds to be no more than 6 feet apart and 3 feet from the bed's side walls is good practice
5. Special Construction Precautions - Since it is convenient to excavate and fill beds by use of tractors, there is temptation to drive over the bed bottom. This can cause severe compaction and loss of permeability. Beds should not normally be constructed in rainy weather because of the effects of rain and ponding on the permeability of some soils (also somewhat true of trench construction).

SUMMARY OF SYSTEM DESIGN

Seepage Trenches

Trenches are usually 18 to 36 inches wide and 18 to 36 inches deep. They have a 3 to 6 inch layer of stones (1 to 2 inches in diameter) at the bottom.

They are laid nearly level. The perforated or open-jointed drain pipe are laid with an even grade, upon the rock (or a board embedded in the rock). The pipe is covered to a depth of 2 inches with rock. The rock is covered with straw and 6 inches or more of soil.

Seepage Beds

Seepage beds are dug two to three feet deep and have the same depth of gravel (stone) as the trenches, but covering the whole bed bottom. The drain pipes are laid level, 6 feet apart, and covered with stones, straw and earth, as for seepage trenches.

Seepage Pits

These are usually 4 to 6 feet in diameter. The bottom is not covered with stones. The side walls are uncemented stones, brick or cement blocks. Sometimes, where soil is not as coarse as sand, there is a 6-inch space between the side wall and the soil which is filled with will-size stones (1/2 to 1 inch diameter) (See Figure 11).

ABSORPTION SYSTEM

Absorption systems, (disposal trenches). are preferred where the groundwater level is high (encounter water when hole is few to fifteen feet deep); where subsoil is impervious, overlain by previous formation; or, where there is seamy limestone causing concern about contamination of wells or springs.

The absorption field subsurface tile or drain system is usually made by placing open-jointed drain tile, or special perforated pipe, in a bed of gravel in a trench or bed. The trench or bed is usually 24 inches to 30 inches deep; drain lines are placed on a 6 inch deep bed of gravel and then covered with gravel to a depth of a few inches; the trenches are nearly level. The gravel is covered with straw and then backfilled with earth. The trenches are usually from 18 inches to 36 inches wide and on a flat grade (fall of one inch to three inches per 100 feet) (See Figures 9 and 10).

Aerobic Systems -There are many aerobic systems which utilize the basic principles of the "activated sludge process". This means that the sewage must be continually mixed with fine air bubbles for 6 or more hours;the sewage must then pass slowly through another tank so particles of organic material (sludge) can settle out. A large part of that settled sludge is circulated to the inlet of the "aeration tank". This whole process must be operated most of the time,each day,to be successful.

Excess sludge must be removed periodically, usually drained to an artificially built sand bed,where it dries.

The system,when properly operated, does produce a relatively clear and stable (non-odorous) liquid,which is relatively free of pathogens (but it usually must be chlorinated if discharged into streams or near shellfish beds of the sea).

DISADVANTAGES OF ACTIVATED SLUDGE SYSTEMS

This consultant has visited many activated sludge and similar "extended aeration-packaged treatment plants" in developing countries. A high percentage of such systems were observed to function little better than a septic tank. The main problems were:

1. High cost for electrical energy,so blowers or aerators were turned off most of the day.
2. Mechanical devices were not maintained and repair parts were not readily available.
3. Communities could not afford to hire trained operators or to provide the necessary manpower for maintenance, testing, and operation.

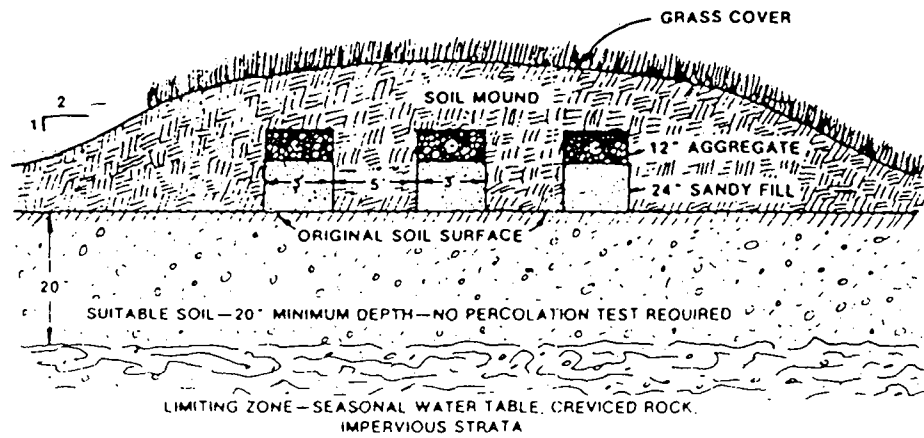

MOUND SYSTEM

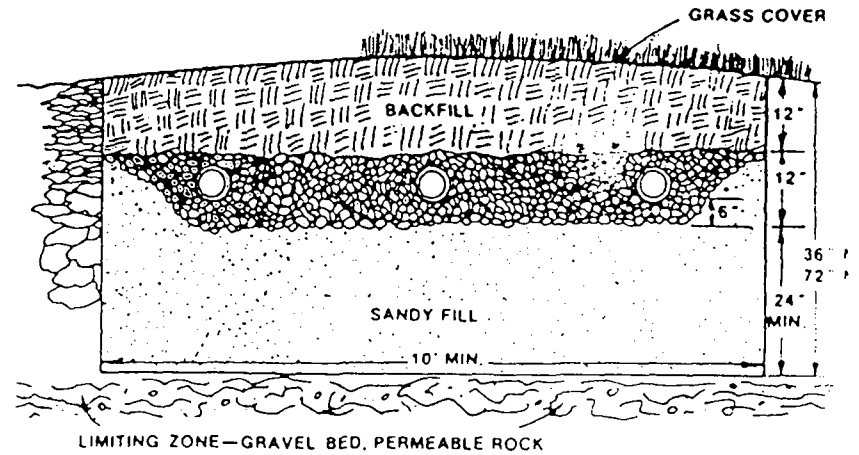

SAND FILL METHOD

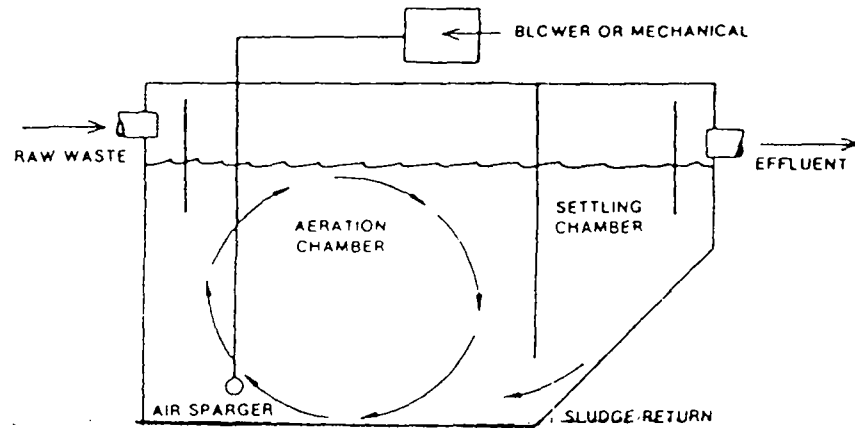

AEROBIC SYSTEM

CONVENTIONAL PUBLIC SEWERS AND SEWAGE DISPOSAL

Public sewers and sewage disposal are the most satisfactory means of excreta and wastewater disposal for built-up, urban type areas. Such sewers must be built with sufficient slope or grade to transport faecal solids and similar material. The quantity of wastewater must be great enough to help flush the material to the disposal site. Manholes are provided each few hundred meters to provide access for cleaning and inspection.

In flat country, as in the Region, it is necessary to lay sewers at grades greater than land surface grades. That results in deep trenches, often into groundwater or difficult-to-excavate limestone. It also requires sewage pumps.

SPECIAL SEWERS - Even in developed countries (U.S.A. for instance) special, lower-cost sewers are being used in special circumstance. One type uses smaller diameter plastic pipe laid on relatively flat grades. This is possible where all wastewater (sewage) has passed through a sedimentation process such as a septic tank, aqua privy or settling compartment of a pour-flush latrine.

Larger systems, such as from a group of living units (apartments) hotels and certain industrial and commercial occupancies can have a simple sump pump to discharge their wastewater to such sewers. That helps produce enough flow to flush the small-diameter lines. If necessary, flushing connections can be provided at the up-stream end of each line. There, portable tanks with pumps can be used to flush the lines, when necessary.

PUBLIC SEWAGE DISPOSAL

SEPTIC TANKS - Septic tanks do not produce a suitably treated wastewater, but such liquid has an unpleasant odor, causes nuisances and kills fish in streams or ditches, and contains pathogens (disease microorganisms).

Also, the large septic tanks needed for public sewerage systems cannot normally be properly cleaned.

STABILIZATION PONDS

For most small to medium-sized communities, especially in warm climates, the most simple, inexpensive and comparatively trouble-free systems are "stabilization ponds" or "oxidation ponds". These are used in both developed and developing countries.

Principles

Sewage contains nitrates, phosphates, potassium and other "plant nutrients". When a relatively shallow pond of sewage is exposed to sunlight a small plant growth (plankton) becomes suspended throughout the liquid. This is a green plant. The green material (chlorophyll) helps produce a good utilization of plant nutrients in the pond. Carbon dioxide, produced by natural transformation of organic carbon, is utilized by chlorophyll-containing small particles of plants, "algae", to form cells of more algae. The oxygen from the carbon dioxide (CO_2) is released to the water where it becomes "dissolved oxygen" (D.O.).

The D.O. accomplishes the same purpose in the stabilization pond as is accomplished by mixing air with sewage in the activated sludge process. In other words, in nitrogen-compound-containing water, there is a growth of microorganisms (protozoa) which convert organic forms of nitrogen (proteins, amino acids and ammonia) to inorganic nitrates, thereby stabilizing the organic compounds. The action produces up to 90% or more reduction in organic pollutants measured by a process which determines how much dissolved oxygen would be required to stabilize a liter of water. This unit is called biochemical oxygen demand. (B.O.D.).

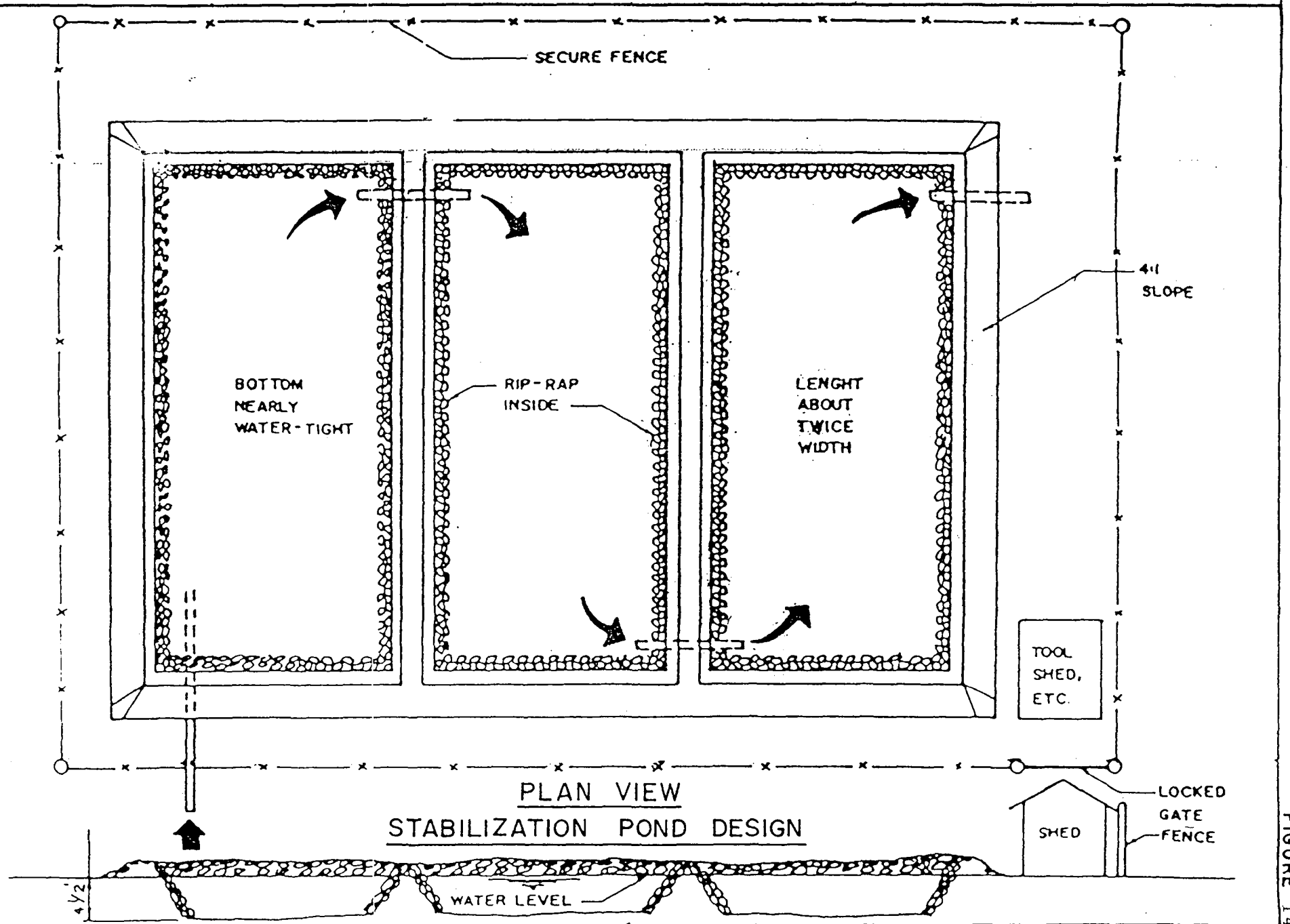

FIGURE 14

Pathogen Removal

Studies in India and elsewhere have shown that when sewage passes through a suitably designed pond system, consisting of at least three ponds, flowing from one to the next, (serial arrangement) over 99% of the coliform and most of the pathogens, including virus and intestinal parasites, are removed.

A typical arrangement and design of a stabilization pond system is shown in Figure 8.

Additional Advantages

Costs are low where land is level, soil is suitable and land costs are not too high.

Maintenance is minimal. Side walls are kept free of weeds or are paved.

Sludge removal is only infrequently necessary.

The effluent of ponds receiving non-brackish water can be used for irrigating. Also, pond effluent which contains algae is good for raising fish.

Where used for private development, which will eventually be connected with a community sewerage system, the ponds can then be filled in and the land is used for development.

CONSERVANCY SYSTEMS

Where Required - Where housing and business establishments are built so closely together that there is no room for pour-flush toilets or septic tank systems and where sewers cannot be built because of cost and other factors, conservancy systems do fill a necessary health need.

Special Features - Ideally, conservancy units are so built that the pail is in a closed chamber which is accessible to the conservancy worker from outside of the building. The base or floor of the space where the pail is kept should be of smooth masonry or plastic and should drain to a small soakage hole.

Pail System - Systems where conservancy workers are required to clean householder's pails expose the workers to additional fecal contact and undesirable labor. The preferable system is to have pails which can "nest" together so a considerable number of empty pails can be carried in a small space. Then clean, empty pails and soiled, used and emptied pails can be carried on the pushcart. Collected pails can be emptied into larger containers on the pushcart.

Within reasonable distances from the houses and shops which are served, there should be properly designed vehicles or subsurface storage tanks into which the filled buckets can be emptied. These need not necessarily be washed until the end of the working day.

If subsurface storage is provided, a vacuum tanker provides an ideal method of emptying those tanks and for transporting and dumping the material in a suitable disposal site.

At that site there should be a bucket-washing device which is equipped with a pump, nozzles and enclosed chambers to wash buckets with a minimum of human contact. (This Consultant noted such systems at Serembran, Malaysia). Wastewater from the washer should flow through a large septic tank to a subsurface absorption system. The wash water could be pumped from a

brackish water well or the sea.

Disposal Site - The final disposal site should be several hundred meters from occupied land. The soil should be reasonably porous to seep away the liquid. It should be several hundred meters from any potable water supply well and should have at least 5 feet of soil above the highest groundwater level or limestone formation.

Educational and Health Programs - Conservancy workers should be given special preventive medical treatment. This should include treatment to help prevent typhoid, cholera and hepatitis Type A.

They should also be trained and supervised to minimize contact with excreta and to practice personal hygiene. Ideally, they would have, at their headquarters, shower and washing facilities.

APPENDIX I

UNDERGROUND TRAVEL OF CONTAMINATION

There are several reports on tests which were made to learn how far bacteriological contamination will travel in various soil and rock formations. The findings were:-

1. DIRECTION OF TRAVEL

If the direction of flow of the groundwater is known or can be discovered, then it is known that bacteriological contamination will flow in the same direction as the water.

2. FILTRATION IN SOILS

Scientists like Hazen and others found, from tests, decades ago:

- a. Under a privy vault in non - saturated, fine (loam) soil, no coliform organisms traveled more than 3 feet vertically downward.
- b. In sandy soils with shallow groundwater, contamination from a test latrine was found to concentrate in the top few feet of groundwater. This led to the principal of some codes which advise that well casing should be water - tight for several feet below the lowest level in the well, during pumping.
- c. Underground travel.
In a test program at the University of California, contaminated wastewater was injected into a layer of sand mixed with small stones. The maximum distance the contamination traveled was 100 feet. Even when the test continued for many months, the distance of travel did

not increase.

d. Path of travel in sand.

This Consultant made extensive tests in a rather coarse sandy soil. Septic tank liquid was applied for months. Underground collection systems were installed ("Lysimeters".) Test holes were dug. The test showed that the septic tank liquid did not travel straight down but spread out into a 20 foot diameter circle. Vertical travel of 8 feet downward removed all coliform, even in this coarse sand.

3. CONCLUSIONS - FOR GRANULAR SOILS

In soils ranging from coarse sand to clay the travel of bacteriological contamination is directly related to,

- a. Direction of flow of groundwater.
- b. Depth of well casing below the water table surface.
- c. Size of soil particles, with fine soil producing very high purification in a few feet of travel.
- d. Contamination introduced directly into the water table flows much farther than contamination introduced into non - saturated soil.

4. CONTAMINATION TRAVEL IN ROCK

Where a water supply is obtained from crevices, channels and other openings in rock, especially limestone, the bacteriological contamination will flow in the same direction as the groundwater and will travel for long distances. There is no filtration, for purification, so the distance contamination will travel depends upon the rate of flow, much the same as travel of contamination in a stream.

The distance can be several miles.

5. SOIL AND GROUNDWATER INVESTIGATIONS

- a. Test holes to determine soil, rock and groundwater conditions.
- b. Where necessary, percolation tests (To later have field exercises on conducting observations of test holes and percolation tests).

APPENDIX II

VOLUMES OF EXCRETA FROM

POUR-FLUSH SYSTEMS

The WHO publication, "Excreta Disposal for Rural Areas and Small Communities" provides data on quantities of human excreta.

For example, for privies where water is not used for flushing or personal hygiene, the following are given:

<u>Type Toilet</u>	<u>Volume added per year</u>
Pit Privy - liquid (urine) soaks away)	1.5 cu. ff. per year
Pit Privy - no seepage	19.5 cu. ff. per year.

AQUA PRIVY.

(Would be same for pour-flush, water - seal latrine having a water - tight vault).

Volume = 4.5 = 1 imp. gal/day

(2 gal/day/capita recommended for design).

Volume, then = 365 imp.gal/person/year =

438 gal/capita/year =

58 c.f./capita/year.

If vault was water - tight and as large as septic tank 3' wide; 9' long, 4'deep = 1000 gal = 133 c.l.

If used by family of 6 persons.

Total quantity per year = 58 x 6 = 348 c.f./year

The tank would fill $348 \div 133 = 2.6$ times per year.

However, the WHO publication suggests for design (to make allowance for 3 unusual circumstances, assume twice as much waste per capita per year. That would mean that some tanks would have to be pumped $2.6 \times 2 = 5.2$ times per year or about every two months.

Water - Sealed latrine with soak - away vault.

In this case the volume would be only the quantity of feces per year, or about 1.5 c.f./capita/year.

For the family of 6 the volume of feces would be $6 \times 1.5 = 9$ c.f./year.

Assume the vault was 3' wide; 5' long and 4' deep or 500 gallons (66 c.f.).

This would need to be emptied $66 \div 9 =$ once in 7 years.

The above data should be checked in Jaffna by experienced observers, but do provide evidence to show the importance of trying to provide vaults from which the liquid will drain.

The data also show that if there is no provision for seepage of liquids into the soil, there would be a large pumping, hauling and disposal problem. That is why it appears reasonable to provide small - diameter plastic drain pipes to dispose of liquids from pour-flush latrine vaults. Then the vaults would not have to be pumped more often than once in several years.

SPECIAL STUDIES OF SOIL AND GEOLOGY

Both from the question of obtaining well water and disposing of waste water it is important to have good knowledge of local geology and hydrogeology. It is also important to accept the advise of the Regional Water Resources Board Engineer who advised at the Introductory Training Program that rock formations, soil conditions and water quantity can be very ununiform - can change much within short distances. However, it is also good to have good knowledge of those conditions which have been found to remain uniform throughout whole areas.

TEST HOLES

There are several types of test holes. This Manual describes the holes for making percolation tests. In addition it is wise to make additional tests to:

1. Learn depth and type of soil below the bottom of the proposed seepage system. It is into this formation that the water must seep. This tells if there is the necessary two foot depth of soil above limestone.
2. Observe soil colors and formations and otherwise note the highest level of the water table.
3. Examine the soil to determine if it is of a type suitable for seepage of waste water.

OTHER OBSERVATIONS

Always try to make sure a new excreta disposal system will be so located as to not contaminate any nearby well, including those on neighbour's property.