

**GRASS ROOT LEVEL  
TRAINING MODULE**



**CONSTRUCTION OF HOUSE HOLD LATRINES AND OTHER  
RURAL SANITATION FACILITIES.  
TRAINERS' GUIDE**



1996

**RAJIV GANDHI NATIONAL DRINKING WATER MISSION**  
**MINISTRY OF RURAL AREAS, AND EMPLOYMENT**  
**GOVERNMENT OF INDIA**

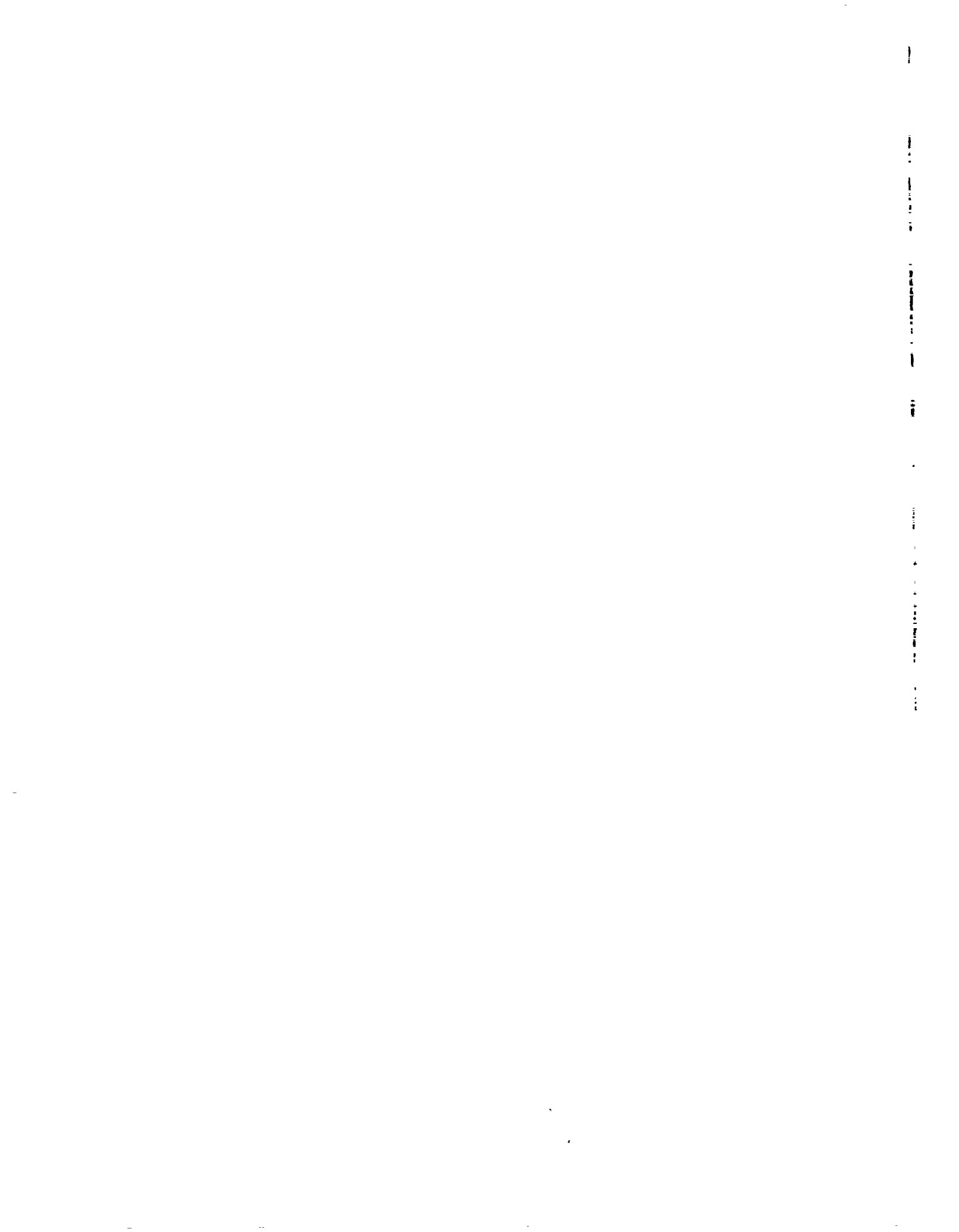

# RAJIV GANDHI NATIONAL DRINKING WATER MISSION

MULTI-MEDIA PACKAGE ON CONSTRUCTION OF LOW  
COST LATRINE AND OTHER RURAL SANITARY FACILITIES

LIBRARY IRC  
PO Box 93190, 2509 AD THE HAGUE  
Tel.: +31 70 30 689 80  
Fax: +31 70 35 899 64  
BARCODE: 13755-1  
LO: 323.1 96MU

## TRAINERS' TRAINING MODULE

*Developed By*

INSTITUTE OF PUBLIC HEALTH, POONAMALLEE, MADRAS  
(DEPARTMENT OF PUBLIC HEALTH AND PREVENTIVE MEDICINE)  
GOVERNMENT OF TAMIL NADU

**AND**

TECHNICAL TEACHERS' TRAINING INSTITUTE TARAMANI,  
MADRAS  
(MINISTRY OF HUMAN RESOURCE DEVELOPMENT GOVERNMENT OF INDIA)





## POLITICAL COMMITMENT

" ..... DEVELOPMENT IS NOT JUST FACTORIES, DAMS AND ROADS. DEVELOPMENT IS BASICALLY ABOUT THE PEOPLE. THE GOAL IS THE PEOPLE'S MATERIAL, CULTURAL AND SPIRITUAL FULFILMENT. THE HUMAN FACTOR, THE HUMAN CONTEXT IS OF SUPREME VALUE.

WE MUST PAY MUCH GREATER ATTENTION TO THESE QUESTIONS IN FUTURE. THE SEVENTH PLAN PROPOSES BOLD INITIATIVES IN THESE AREAS.

OUTLAY FOR HUMAN RESOURCES DEVELOPMENT HAVE BEEN SUBSTANTIALLY INCREASED POLICIES AND PROGRAMMES IN EDUCATION, HEALTH, WELFARE MUST ALSO BE RESTRUCTURED TO PROVIDE A FULLER LIFE TO OUR PEOPLE".

RAJIV GANDHI  
PRIME MINISTER OF INDIA  
[FORWARD TO SEVENTH FIVE YEAR PLAN]

## ACKNOWLEDGEMENTS

Grateful acknowledgements for the development of this module and the multimedia package on House Hold Latrine and Sanitary Facilities are due to

1. Dr.K.V.SHANTHA,  
Director of Public Health and Preventive Medicine, (Training),  
Tamil Nadu, Madras - 600 006.
2. Dr.M.NARAYANA RAO  
Principal, Technical Teachers' Training Institute,  
Taramani, Madras - 600 113.
3. Dr.P.K.RAJENDHARAN,  
Deputy Director of Public Health & Preventive Medicine,  
Institute of Public Health, Poonamallee, Madras - 600 056.
4. Prof.P.DAYANITHI,  
Professor and Head of Department of Civil Engineering,  
TTTI, Tharamani, Madras.
5. Dr.G.PRAKASH,  
Asst. Officer Incharge, IPH, Madras - 600 056.
6. Er.E.S.M.SURESH,  
Lecturer in Civil Engineering, TTTI, Tharamani, Madras - 600 056.
7. Er.R.HARIHARAN, Public Health Sanitary Engineer, IPH, Madras - 56.
8. Mr.T.M.SWAMIRAJAN, Research Aide, IPH, Madras - 56.
9. Miss.R.MEERAH, Public Health Nurse (Trg), IPH, Madras - 56.
10. Mr.T.M.SUBRAMANIAM, Artist, IPH, Madras - 56.
11. Mr.DAMODARAN, C.O., IPH, Madras - 56.
12. Mr.RAJENDRAN, PC to the Director of PH & PM, Madras - 6.
13. The staff of the Directorate of PH & PM, Madras - 6

and the staff of the Institute of Public Health, Madras for their guidance, inspire, contribution respectively.

<i>SL.No.</i>	<i>CONTENT</i>	<i>Page No.</i>
1.	<i>Objectives</i>	1
2.	<i>Contents</i>	3
3.	<i>Training Schedule</i>	4
4.	<i>Training Strategies</i>	6
5.	<i>Time Schedule</i>	7
6.	<i>Training Network</i>	9
7.	<i>Project Dimension &amp; Benefits</i>	10
8.	<i>Training Techniques</i>	13
9.	<i>Strategies of Community motivation and mobilization</i>	14
10.	<i>Schematic Layout</i>	15
11.	<i>Banners</i>	16
12.	<i>Audio - Visual Aid</i>	19
13.	<i>Promotion of Heath</i>	28
14.	<i>Sanitary Barrier Creation</i>	30
15.	<i>Sanitary Disposal of Excreta</i>	32
16.	<i>Community Mobilization &amp; Participation</i>	33
17.	<i>Conducting Health Education Activities</i>	36
18.	<i>Removal of obstacles</i>	43

# CONSTRUCTION OF HOUSE HOLD LATRINES AND OTHER SANITATION FACILITIES

THIS PACKAGE IS MEANT FOR ARTISANS AND TRAINERS SELECTED FROM THE COMMUNITY LEVEL WHOM IN TURN WILL IMPART GROSS ROUTE LEVEL TRAINING TO THE VILLAGERS.

## OBJECTIVES

- 1.0 COMPREHEND THE IMPORTANCE OF RURAL SANITATION
  - 1.1 LIST THE FAECAL-BORNE DISEASES THAT WOULD AFFECT HEALTH
  - 1.2 MENTION HOW LOW COST SANITATION CAN BREAK THE DISEASE CYCLE.
  - 1.3 BRING OUT THE IMPORTANCE OF SOLID WASTE AND EXCRETA DISPOSAL.
  - 1.4 ENUMERATE THE POINTS TO BE CONSIDERED FOR ACHIEVING POSITIVE HEALTH.
  - 1.5 MOTIVATE AND INVOLVE THE COMMUNITY



- 2.0 KNOW THE CONSTRUCTION AND MAINTENANCE DETAILS OF A HOUSEHOLD LATRINE.
  - 2.1 ENUMERATE CONSTRUCTION OF VARIOUS COMPONENTS/PARTS OF THE SINGLE/DOUBLE PIT LATRINES (POUR FLUSH TYPE)
  - 2.2 PROVIDE NECESSARY DRAIN CONNECTIONS FOR THE LATRINE.
  - 2.3 LIST THE POINTS TO BE CONSIDERED FOR PROPER MAINTENANCE OF LATRINES.
  
- 3.0 CONSTRUCT SINGLE/DOUBLE PITS POUR FLUSH LATRINE.
  - 3.1 SELECT PROPER SITE FOR LATRINE CONSTRUCTION.
  - 3.2 DRAW THE LAYOUT FOR THE CONSTRUCTION.
  - 3.3 DO THE ACTUAL DIGGING FOR THE PIT.
  - 3.4 UNDERTAKE BRICK LINING FOR THE PIT.
  - 3.5 CONSTRUCT THE SEAT FOR THE LATRINE.
  - 3.6 MAKE ALL THE CONNECTION (PAN, TRAP, OUTLET ETC.,)
  - 3.7 MAKE THE SUPER STRUCTURE.
  - 3.8 COMMISSION THE LATRINE FOR USE.
  
- 4.0 STATE OTHER SANITARY FACILITIES CAN BE PROVIDED IN A RURAL VILLAGE.
  - 4.1 DESCRIBE DISPOSAL OF THE WASTE WATER, GARBAGE, AGRICULTURAL PRODUCTS AND OTHER DAILY WASTES.

## CONTENTS

### 1. IMPORTANCE OF RURAL SANITATION

- \* Ecological factors
- \* Disease cycle and human reservoir
- \* Faecal - borne diseases
- \* Importance of solid waste management
- \* Importance of Excreta disposal
- \* Points on promotion of health
- \* Community mobilization through health education

### 2. CONSTRUCTION OF LOW COST LATRINE (RCAP)

- \* Construction details of two pit latrine (pour flush type)
- \* Materials used for RCAP latrine
- \* Connection details of single/two pit latrine
- \* Maintenance of latrine - points to be emphasized
- \* Technical details

### 3. OTHER SANITARY FACILITIES IN RURAL AREAS

- \* Disposal of garbage and waste out of agricultural products.
- \* Waste water disposal systems.
- \* On-site sanitation and off-site sanitation.

Date & Day Session	Topic	Faculty	Methodology & Aid
<b>DAY III</b> <b>Forenoon</b>			
Session I & II	Field practice • Self learning - construction of latrus continued	PHSE & Trained Maison	Field site
Session III	Community Health Education motivation & Mobilization Role play of participants.	H.Educator & Research Aide (Community Research Experts)	Flip charts posters etc.
Session IV	Doubt Clarification session & Post evaluation  Validiction	All Faculty  All Faculty	Disucssion  Certificate distribution

# RAJIV GANDHI NATIONAL DRINKING WATER MISSION CONSTRUCTION OF HOUSEHOLD LATRINES

## PROPOSED TRAINING SCHEDULE

Date & Day Session	Topic	Faculty	Methodology & Aid
<b>DAY I</b>			
<b>Forenoon</b>			
Session I	Registration, Introduction to the Project, Need Assessment	All Faculty	Class Room Discussion
Session II	"Sanitary Barrier Creation for Healthful Living"	Health Specialist	Class Room Lecture 35mm slides OHP Transferences.
<b>Afternoon</b>			
Session III	"Type design for a low cost rural latrine"/Estimate size of pit for beneficiaries	Public Health Sanitary Engineering Specialist	OHP - Transferences 35mm slide
Session IV	Video Presentation/Exhibition of Photographs & various parts of Latrine models	Cinema operator PHSE. & P.H. Speacilist	TV & VCR - Casting 1 moulding parts
<b>DAY II</b>			
<b>Forenoon</b>			
Session I	Field Observation • Site Selection • Earth Excavation for Basement construction & Leach pits.	PHSE & Trained Masons	Selected Field site
Session II	Construction and Maintenance of a low cost latrine	PHSE	Class Room Discussion- A.V. Aides
<b>Afternoon</b>			
Session III & IV	Field Practice - Construction of a two pit latrine	PHSE - Trained Mason	Selected site

## TRAINING STRATEGIES

- \* Simple lecture and discussion with Audio-visual aids.
- \* Construction demonstrations
  - paper lay out
  - model demonstration
- \* Graded exercises for skill development
  - field lay out
  - moulding of components
  - actual construction of a two pit latrine by trainees
- \* Role play to motivate community
  - mobilization
  - participation
- \* Evaluation

## MULTIMEDIA PACKAGE

The MULTIMEDIA PACKAGE will consist of:

- \* Trainer Manual and Guide
- \* Trainee Module
- \* Video Programmes
- \* Flip Charts
- \* Photographs
- \* 35 mm Slides
- \* OHP transparencies

## TRAINERS' TRAINING-TIME SCHEDULE

CORE TRAINERS	:	Experts from the field of Public Health and P.H. Engineering from Training Institutes.
TRAINERS	:	Artisans Masons and Selected group among the community
VENUE	:	Training Institutions
TRAINEES' STRENGTH	:	20 + 25 per batch
DURATION OF TRAINING	:	3 days = Total 18 Hours
TIME	:	10.00 a.m. to 5.00 p.m.

### ALLOTTMENT OF HOURS

1.	Lecture discussion (with A.V. aids)	:	6 Hours
2.	Video presentation	:	1 Hour
3.	Field demonstration	:	10 Hours
4.	Field area visit	:	3 Hours
5.	Other formalities	:	3 Hours
			<hr/>
			18 Hours
			<hr/>
Sessions	:	10.00 to 11.15 am. 11.15 to 11.30 am Tea Break 11.30 to 01.00 pm 01.00 to 02.00 pm Lunch Break 02.00 to 03.15 pm 03.15 to 03.30 pm Tea Break 03.30 to 05.00 pm	

## TRAINING MATERIALS

- \* Trainers and Trainees Modules
- \* Flip Charts
- \* Photographs
- \* Posters

## EVALUATION

- \* Pre evaluation (need assessment)
- \* Doubt clarification sessions
- \* Role play on community mobilization & participation
- \* Post evaluation
- \* Certificate distribution

## CERTIFICATE DISTRIBUTION

# TRAINING NETWORK

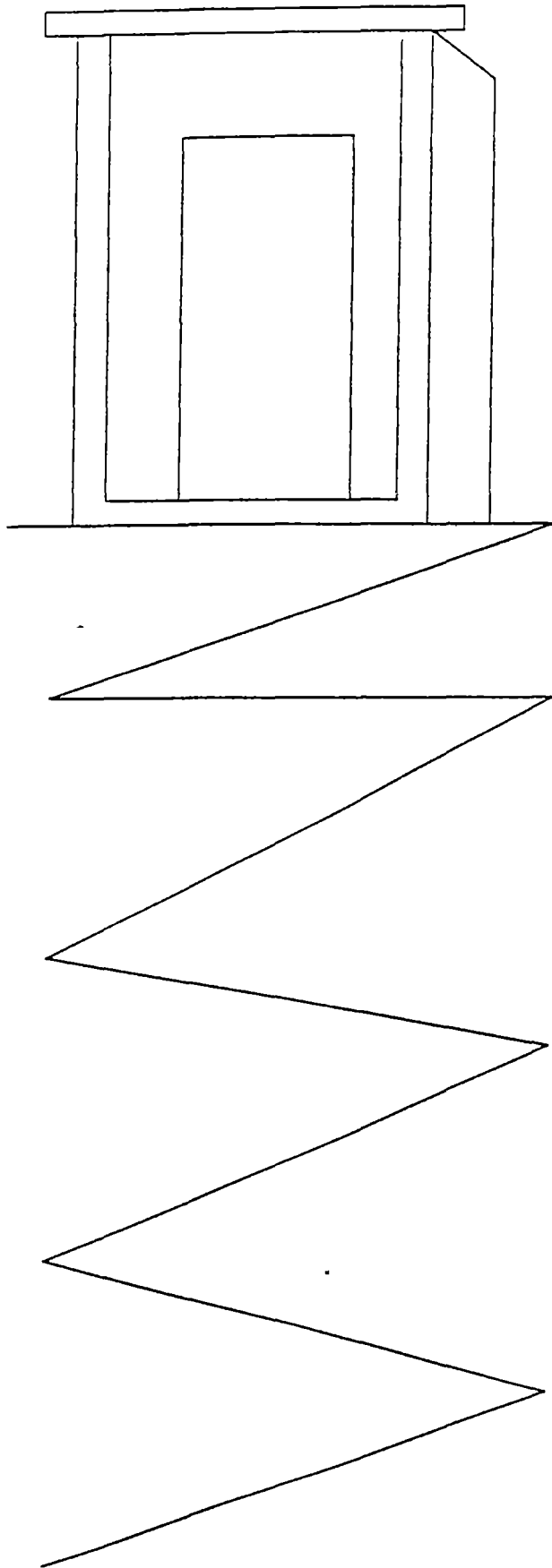

Village level beneficiaries



Change Agents at village level



Core Trainers  
(Artisans & Masons)



Experts from the field of  
Public Health and Sanitary  
Engineering, Community  
motivators.



## PROJECT DIMENSIONS AND BENEFITS

### INTRODUCTION

Ever since Independence, the Government at the capital laid emphasis on improving the general quality of life, the standard of Living conditions, prevention of Infections diseases and improvement of Health Status of the rural mass, the largest population of our country.

The National Health policy paved a clear path for reaching the target goal of "HEALTH FOR ALL BY 2000 AD" through the Primary Health Care delivery system following the ALMA ATTA DECLARATION OF 1978.

The Development programmes have been planned and directed towards the basic felt needs of the people namely.

- Providing basic civic amenities to all villager and there by improve the Health of the rural people and to enhance a productive life and increase the "expectancy of life at Birth" (Life span) through Healthful Living Conditions.

This is possible only by

- Improving the two ecological universes namely the Internal and External Environment of man.
- Providing safe and protected water supply.
- Providing Healthy environment
  - a sanitary latrine for a house
  - sanitary disposal of the solid and liquid wastes.
- Control, prevention and Eradiction of communicable diseases.

## RATIONALE

Rajiv Gandhi National Drinking Water Mission, Govt. of India, is committed to serve in this direction, providing.

- Safe drinking water to villages
- Sanitary Latrine to all House holds through the norms of the four well marked principles of the Primary Health Care:
  - \* Equitable Distribution
  - \* Community Participation
  - \* Intesectoral Co-ordination and
  - \* Appropriate Technology

## STRATEGY

This multimedia package on the construction of Rural, Household, Low Cost, Sanitary Latrines envisages to build capability by imparting trainings to the selected core group to provide.

- knowledge
- skill and develop
- Attitudinal change

The core Trainers in tern to disseminate this knowledge and skill to the needy at all villages.

After the Training the core Trainers will be able to motivate the community and mobilize them to participate in the programme.

The core group will learn about

- \* Faecal borne diseases
- \* Mode of spread
- \* Importance of a sanitary Latrine
- \* Importance of Implementation of programme
- \* Mobilisation & Motivation of the community.

The core group will develop skill

- \* Procuring local materials
- \* Create parts at a lower cost
- \* Site selection
- \* Estimation of pit size
- \* Construction of a Latrine
- \* Demonstrate cost effective benefits

The core group will provide

- \* Supportary supervision
- \* On the job training
- \* Maintenance Technies
- \* Knowledge, skill for a sustained use.

The core group will Bring forth

- \* A change of attitude among the people
- \* A change in false belief & Traditional practices
- \* A change in life style
- \* A change in the Insanitary village
- \* A change towards Positive Health.

## TRAINING TECHNIQUES

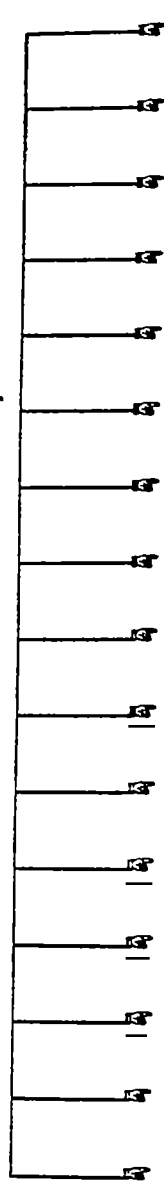
- 
- Provide Information
  - Provide Field Proofs
  - Tell Success Stories
  - Allow discussions
  - Clarify Doubts
  - Demonstrations for observations
  - Practicals for Self Learning
  - Develop Confidence of doing it self
  - Train to motivate community
  - Train to use A.V. Aides
  - Certify for Self excellence
  - Bring out the confidence and competency
  - Monitor & supervise project work
  - Provide on the job training
  - Provide suportary super vision & paracticals
  - Maintain contact

## STRATEGIES OF COMMUNITY MOTIVATION & MOBILISATION

### 1. Provide Health Education

- Concerning the prevalence of locally endemic & epidemic diseases and the means of preventing them through personal hygiene, environmental hygiene.
- Creating Awareness on the benefits of the project and create a pullig demand to seek assistance and the availability of the service.
- The provides and the create a demand to know more about the benefits of the project.
- Motivation

The self motivated people directly seek assistance and guidance for a construction or for a Technical know how.

The people motivated by the influencing agents of the project be shown the proof of benefits.

For sustained chain of demand influence the volunteers to follow safe practices covered under the project.

- Demand Generation can be done by exhibiting the benefits of those who have adopted the practices of using a sanitary latrine in the same village or nearby places.

This will generate great enthusiasm and create more demand.

### MOBILISATION

The self method and the easily motivated individuals will greatly influence others and make easy our task. If the change agents be the leaders and the influencing personalities among the community the task is much more easier. Hence influence the Head whom in term will mobilise the mass and mobilize even the local resources for easy going. The task of motivation become easier through these influencing agents.

### COMMUNITY PARTICIPATION

When the benefits are made very clear the people particepate in their own learning & doing. They tend to help one another generate resources locally and bring forth cost effective benefits.

- Total change towards positive attitude.

# MULTI MEDIA PACKAGE ON MOTIVATION FOR COMMUNITY SUPPORT MOBILIZATION

## Schematic Layout of the Package

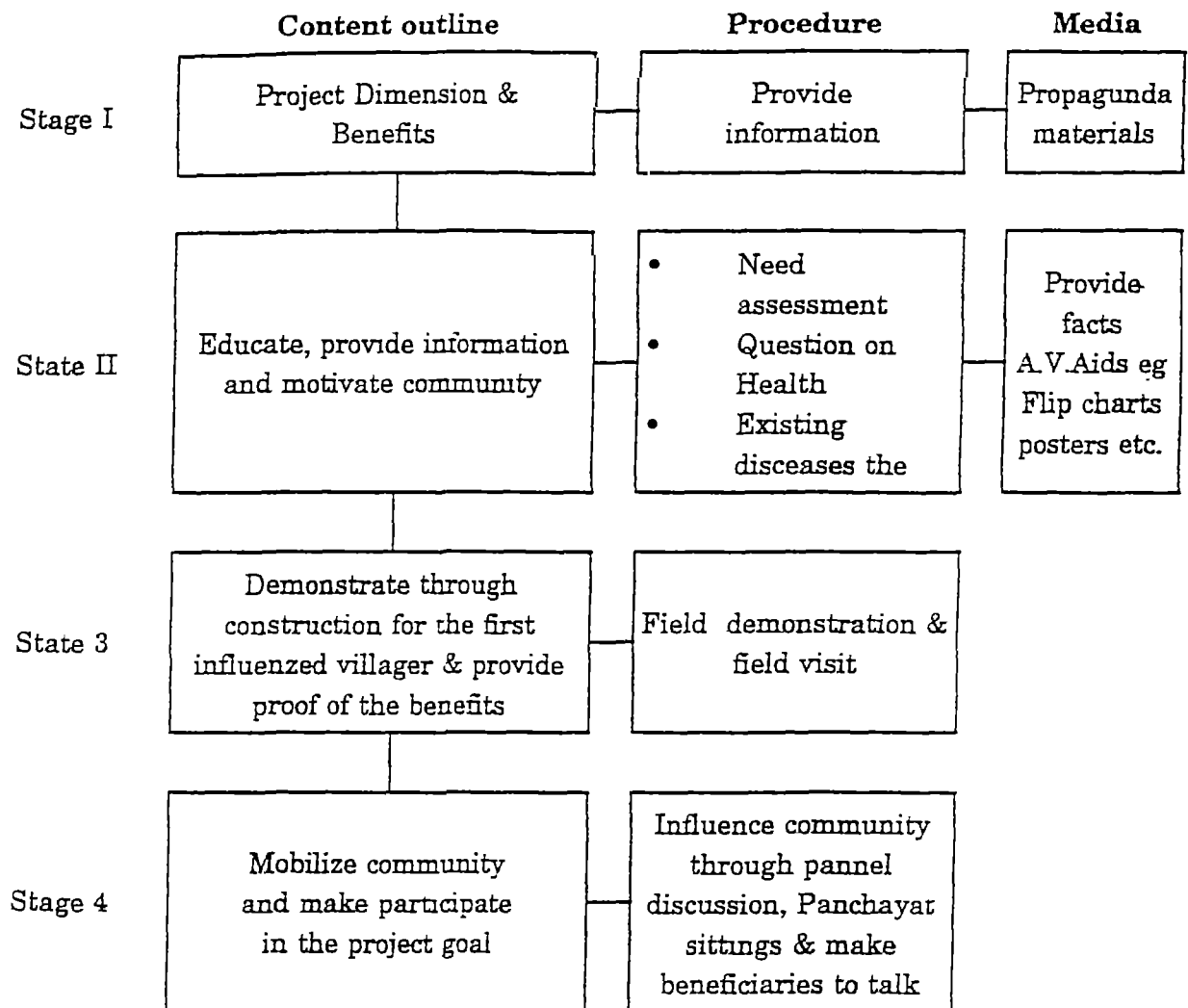

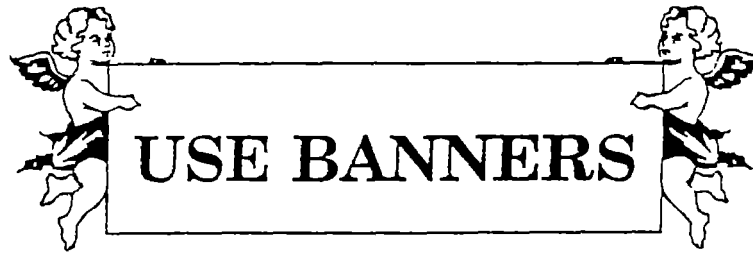

A project of the people by the people and for the people

Out village - a model for the country

Water is life  
Sanitation 'its' length

"Regular maintenance long live its 'Service'"

"Have a house hold Latrine live Health"

"Teach Children to use Latrine  
Habits in young die hard"

"Clean Environment for Health & Happy life"

MULTIMEDIA PACKAGE ON CONSTRUCTION  
OF HOUSEHOLD LATRINES AND OTHER  
BANITATION FACILITIES  
(SPONSORED BY RAJIV GANDHI-  
NATIONAL DRINKING WATER MISSION)

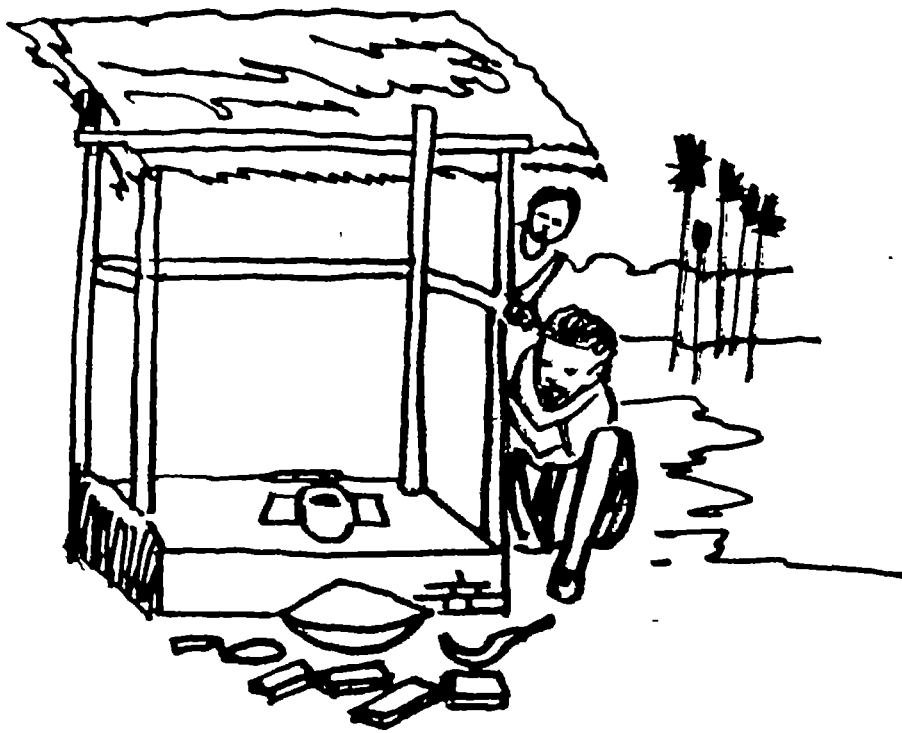

DEVELOPED BY

INSTITUTE OF PUBLIC HEALTH TECHNICAL TEACHERS  
ONAMALLEE-MADRAS TRAINING INSTITUTE  
DEPT - DPH & PM TARAMANI-MADRAS  
TAMILNADU (MINISTRY OF HUMAN RESOURCE  
DEVELOPMENT, GOVT OF INDIA)



# MULTI MEDIA PACKAGE ON CONSTRUCTION OF HOUSEHOLD LATRINES AND OTHER SANITATION FACILITIES

## Audio - Visual Aid

### I. 35mm POSITIVE CINEMA SLIDES

Slide Nos.	
No.1 -	<p style="text-align: center;"><b>"PACKAGE HEADING"</b></p> <p>Introduction to the Programme of Training on "the Construction of Household, Low Cost, Rural water seal latrines and other sanitation facilities".</p> <p>The Sponsors, the organisers and Institutes involved in the development of the package and training.</p>
No. 2 -	<p style="text-align: center;"><b>"EPIDEMIOLOGICAL TRIAD"</b></p> <p>The three factors - Agent (disease producing germ) Host (Susceptible Human) and the environment (Sanitary Condition) influences each other to either resist or acquire a disease.</p>
No.3 -	<p style="text-align: center;"><b>"HUMAN RESERVOIR OF DISEASES"</b></p> <p>Human being acts as a Reservoir of germs. Some of them becomes pathogenic - disease producing agents in another New Host.</p> <p>The infected faeces spreads diseases through contamination of soil, water, uncleaned fingers, fomites, flies and unprotected food.</p>
No.4 -	<p style="text-align: center;"><b>FAECAL BONE DISEASES</b></p> <p>Diseases from viral, bacterial, protozoal and intestinal worms (Helminthiasis) are transmitted out of the infected faeces to new and succesptible Hosts.</p>
No.5 -	<p style="text-align: center;"><b>INDISCRIMINATE DEFAECATION</b></p> <p>A common site of Indiscriminate Defaecation in our country. Here the children are defaecating openly on the bank of the lake.</p>

Slide Nos.	
	They are washed in the water which gets contaminated. Even the steels of an infant is not safe. Children are tendered by this habit which becomes difficult to be changed at later age.
No.5(a) -	<p style="text-align: center;"><b>CHILDREN DEFAECATION</b></p> <p>Showing the water source</p>
No.6 -	<p style="text-align: center;"><b>WATER POLLUTION</b></p> <p>Water Pollution through washing the cattle and bathing of human beings in the same pond. The same water is used for drinking purposes, which is contaminated by human and animal waste.</p>
No.7 -	<p style="text-align: center;"><b>LADIES FETCHING POLLUTED WATER</b></p> <p>Though most of the villages are provided with safe water - they are very limited and supplied only at a restricted times.</p> <p>Here due to habituation, the women fetch water from lakes, ponds and rivers which is contaminated by animal washing, cloth washing, bathing and washing after defaecation.</p>
No.8 -	<p style="text-align: center;"><b>LAYOUT SKETCH</b></p> <p>Blue print of the area for location and site selection for constructing a House Held Latrine before excavation of earth.</p>
No.9 -	<p style="text-align: center;"><b>EXCAVATION OF EARTH FOR BASMENT</b></p> <p>Various dimensions for excavating earth for the construction of basement for a squatting platform and two pits - Latrins.</p>
No.10&11 -	<p style="text-align: center;"><b>STAGES OF BASEMENT FORMING FOR PITS</b></p> <p>Arrangement of Bricks like a span with 7 cm inserted into a room created under the earth over which two layers of Brick in cement mator is formed.</p> <p style="text-align: center;">For 5 users 0.90m Diameter and 1.1 in Depth  For 10 users 1.20m Diameter and 1.2 in Depth  For 15 users 1.30m Diameter and 1.4 in Depth</p>

Slide Nos.	
No.12 & 13 -	<p style="text-align: center;"><b>BASEMENT WORK FOR SQUATTING PLATFORM</b></p> <p>A Brick ballast or a cement concrete a 15 cm layer is formed for the basement constructions for the squatting platform - for stability.</p>
No.14 -	<p style="text-align: center;"><b>MOULDING/CASTING PARTS FOR A LATRINE</b></p> <p>The parts required for a latrine can also be done through moulding or casting parts like two straight pipes for a two pit latrine, 'a' 'y' pipe for connecting the waterseal and pit pipes, a water seal connection all of even diameter inside and even a cement pan can also obtained at short time and more numbers through moulding or casting.</p>
No.15 -	<p style="text-align: center;"><b>SQUATTING PAN</b></p> <p>Various types and models of squatting pans may be used. Commercially available ceramic pans, prefabricated materials like fibre glass pan also be used or as shown in the fig - a cement moulded pan can also be fixed.</p> <p>All the pans should have a good sloping angle towards the water seal and a very smooth surface.</p>
No.16 -	<p style="text-align: center;"><b>CONNECTING VARIOUS PARTS</b></p> <p>The parts of pan - trap - 'y' pipe and straight pipes should be fixed this way and the junctions sealed with cement.</p> <p>An angle of sloping towards the pits should be adopted.</p>
No.17 -	<p style="text-align: center;"><b>STRAIGHT PIPE</b></p> <p>For a single pit Latrins a straight pipe is used and there is no need for a 'Y' pipe. However an inspection chamber may become a necessity between a straight pipe and the water seal to remove blockade if any.</p> <p>Here the two pipes for a two pits latrine.</p>

Slide Nos.	
No.18 -	<p style="text-align: center;"><b>‘Y’ PIPE WITH INSPECTION HOLE</b></p> <p>‘Y’ casted pipe for a two pit latrine with an Inspection Chamber.</p> <p>One pit is used at a time. When one pit is full it may be closed and the second pit is opened.</p> <p>The entrance site of the ‘Y’ pipe may be blocked by a dummy clay</p>
No.19 -	<p style="text-align: center;"><b>‘Y’ PIPE LID CLOSED</b></p> <p>The ‘Y’ pipe inspection lid is always kept closed and hermetically sealed to avoid flies and mosquitoes. Earth may be laid over this pipe to keep it covered and protected.</p>
No.20 -	<p style="text-align: center;"><b>WATER SEAL TRAP</b></p> <p>The water seal trap pipe has a 70mm Diameter ceramic fibre glass or PVC may also be used. A water seal level is always maintained to create a barrier between the flies and the pits or faces.</p>
No.21 -	<p style="text-align: center;"><b>PAN AND TRAP SETUP</b></p> <p>The position of the pan and the water seal trap is shown. Note the angle of the pan slop and the position of the water-seal trap.</p>
No.22 -	<p style="text-align: center;"><b>COMPLETED TWO PITS</b></p> <p>The pits to be elevated from the ground level to avoid see page of water into the pits. The location of the pits should be away from water sources (15m) and have adequate depth depending on the number of users and their habits and should not be located at a flooding area.</p>
	<p>The pits can be constructed within the premises or outside the premises or even at common paths provided they have protected concrete covering slab or other slabs of adequate strength.</p>
No.23 -	<p style="text-align: center;"><b>PREFABRICATED LATRINE</b></p> <p>The squatting pan, the foot rests and the connecting pipes are made of prefabricated material like fibre glass which is easlier than the conventional types.</p> <p>Even the superstructure is an single concrete casting.</p>

Slide Nos.	
No.24 -	<p style="text-align: center;"><b>RCAP SQUARE - SINGLE PIT</b></p> <p>This is a Research Cum Action Project Pit Square in dimensions with reduced Honey Comb Formation for stability. For economic reasons a single pit is just sufficient.</p>
No.25 -	<p style="text-align: center;"><b>STONE WARE LINING PIT</b></p> <p>Instead of brick lining, stone ware lining can also be used in the pits.</p> <p>It can again have holes instead of Honey-Comb formation in the pits of brick work.</p> <p>Costlier than the brick but more stable.</p>
No.26 -	<p style="text-align: center;"><b>SUPER STRUCTURES</b></p> <p>Depending upon the Economic Condition and taste the superstructure may be built over the squatting platform. Either a brick wall with a ceiling to protect during the rains and Sun.</p> <p>or simple and cheaper materials can also be used. This is thatched structure without a roof as some people still prefer an "open air" and resist to enclosures.</p>
No.26(a) -	<p style="text-align: center;"><b>RCAP SUPER STRUCTURES</b> as explained before.</p>
No.27 -	<p style="text-align: center;"><b>SMOKELESS CHOOOLA</b></p> <p>This is another necessity for a small, rural single roomed house or when the kitchen and living room is the same.</p>
	<p><b>ADVANTAGES</b> : Even when fire-woods are used. The fire is fed with air to burn fully through the holes at the side. Also the inlet air passes off only through the pot hole and enhances the increasing flame and burning is therefore full and complete.</p> <p>Smoke is almost nil or less when compared to a common choola.</p> <p>At a time two vessels may be used for cooking not wasting the energy.</p>

Slide Nos.	
No.28 -	<p style="text-align: center;"><b>OPEN AIR DEFAECATION IN THE GREEN FIELDS</b></p> <p>This is an Hazardous situation in which the indiscriminate defaecation into open green fields especially where cultivation like ground nuts, potato etc - which may be contaminated through the roots and water especially when the vegetables or nuts or roots are eaten raw or half cooked or improperly washed - leads to epidemics of cholera, Diarrhoca and Dysentries.</p>
No.29 -	<p style="text-align: center;"><b>SANITARY WELL</b></p> <p>A Sanitary well should have a Platform encircled to the Parapet Wall and a small drain leading to a seak pit.</p> <p>The top of the well may be closed hermetically to avoid inspects and dirt falling into the well by providing hand pump adjacent to the Parapet Wall.</p> <p>Here the well is chlorinated with a Bleaching Powder of 33% stable chlorine for disinfection.</p>
No.30 -	<p style="text-align: center;"><b>SANITARY WELL CHLORINATION</b></p> <p>Different View.</p>
No.31 -	<p style="text-align: center;"><b>STONE WARE PIT LINING</b></p> <p>The Stone ware lining used for well lining is used as an alternative device. Costly but stable.</p>
No.32 -	<p style="text-align: center;"><b>BATHING IN POND</b></p> <p>The ways of polluting a water sources through direct assessibility.</p>
No.33 -	<p style="text-align: center;"><b>SMOKELESS CHOOOLA</b></p> <p>Another View (Close)</p>
No.34 -	<p style="text-align: center;"><b>SUPER STRUCTURE OF PREFABRICATED LATRINE PARTS</b></p> <p>The Superstructure including all the components out of prefabricated materials.</p>

## A.V. AIDES

- II. Photographs : Display the photographs of
- Environmental pollution
  - Water pollution
  - Field pollution & spread of disease
  - Bad Habits of people
  - Types of existing latrines etc.

Explain to them about all.

## III. OHP - Transference

Set of Transference

Slide Nos.		
No.1	-	Rajivi Gandhi National Drinking Water Mission. Its dedication & commitment & the Institutions involved in the Training programme
No. 2	-	Epidemiological Trad Agent - Disease producing organisms Host - Human Enur - Soil, Water, fields Insects. etc their interlink.
No.3	-	How Faecal borne diseases spreads : give examples. • Water by direct washing after defecation. • By contaminating water without proper washing of hands • By defecating into the near by earth close to water sources. • Fingers - unwashed - not soap washed Not cutting nails - eg. Eggs of Intestinal worms Flies - Act as Mechanical carrier for diarrhons Soil - going into roots of plants eaten raw or half cooked. - through animals - pig. - flies and - Other imects
No.4	-	Why a barrier is necessary How a barrier can be a latrine.

Slide Nos.		
No.5	-	Plan for a simple, low cost. Sanutary, rural, household, water seal latrine.
No.6	-	Materials required - which can also be contributed or created eq. sand from the river, bricks can be chambered, Instead of cement, lime can be used old but good steel rods there can be transported by the individual or collectively all community can also contribute by involving themselves - contribute physical labour in construction
No.7	-	Details of pan & trap all dimension & water seal - positioning & gradient & connection
No.8	-	Details of Earth excavation & Foundation & plinth for superstructure
No.9	-	Design details for pits within the premises
No.10	-	Leach pit construction details
No.11	-	Layout plan of different situation
No.12		
No.13	-	Details of RCC slab for leach pits of different sizes
No.14	-	Desgin details of leach pits under the Road
No.15	-	Dry & wet pit Details
No.16	-	Different super structures
No.17		
No.18	-	Latrine before use should be wet & water for water seal.
No.19	-	Postitioning feet by children
No.20	-	Care of latrine after Dafecation
No.21	-	Cleaning the pan
No.22	-	Land washing after defaecation for personnel Hygiene
No.23	-	Provision of water near the latrine
No.24	-	Timely repairs of the Latrine
No.25	-	Action I - How to attend to a latrine Blockage
No.26	-	Action II- what to do if the pit gets filled up.



Slide Nos.		
No.27	-	Hazards of open air defaecation
No.28	-	
No.29	-	
No.30	-	Water Pollution
No.31	-	Pollution through other sources
No.32	-	Hazards of House flies
No.33	-	Some exceptional case. hygiene way diseases of ***** practices & sanitary & Enhancement
No.34	-	Housefly Hazards & preventive
No.35 to 38	-	Environmental Sanitation

IV. Demonstration of the casting / moulding parts for the preparation of the parts of a Latrine. Using cement mortar.

1. Casting / moulding for a
- Pan (Cement)
  - Foot rests
  - Water seal bend pipe
  - Straight pipes
  - 'Y' pipe
  - Slab cover for the pits

\* The trainees may be shown the casting models for a large scale preparation  
 \* Actual preparation of the parts & curing.

(OR)

The prepared parts may be exhibited and each part is explained in detail with dimensions.

- Connection of parts
- Gradient
- Repair & Replacement

## PROMOTION OF HEALTH

"Health" in the broad sense does not merely means the "absence of disease". As World Health Organisations defines, "Health is a state of complete physical, mental and social well being and not merely the absence of disease or infirmity". Positive Health indicates the optimism functioning of the body, mind and the mastery over the environment. In the modern concept of Health emergence, Health becomes an essential component in "Improving the quality of life".

### *CONCEPTS OF WELL BEING*

1. Standards of living
2. Level of living
3. Quality of life.

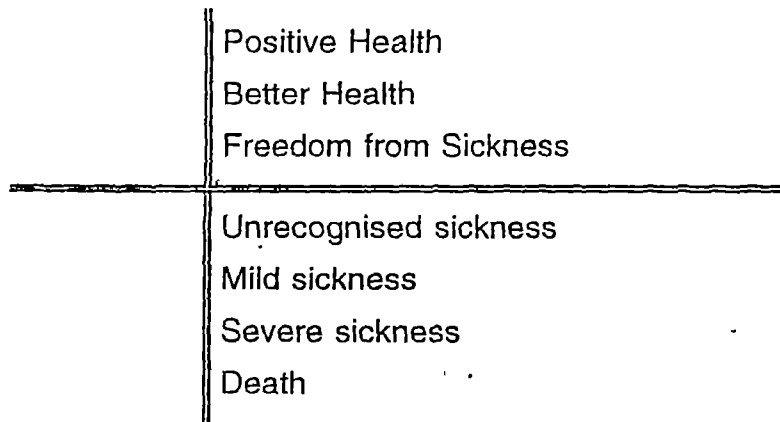

### *INDICATORS*

1. Mortality indicators
2. Morbidity indicators
3. Disability indicators
4. Nutritional status indicators
5. Health care delivery indicators

6. Utilization rates
7. Indicators of social and mental health
8. Environmental indicators
9. Socio-Economic indicators
10. Health policy indicators
11. Indicators of quality of life
12. Other indicators.

Positive Health has no definite indicators. It is a total approach to all human problems. To conquer the total physical health condition with the sound mind and the clean environment.

***IN A VILLAGE,***

*Individual* - Personal Hygiene, good habits and sound mind with participatory attitude in community Programme Implementation.

*Household* - Clean House, adequate ventilation and lightings, clean kitchen, with a smokeless chula, a kitchen garden, a soakage pit, a sanitary latrine and garbage disposable trench.

*Village* - a protected water supply, no open sullage, litter and refuse free zones, no fly and mosquito breeding sources etc.

**"THIS IS THE DREAM LAND FOR A VILLAGE WHICH IS EASILY ACHIEVABLE  
ONLY BY THE PEOPLE'S PARTICIPATION AND SELF MOTIVATION".**

\*\*\*\*\*

## SANITATION BARRIER CREATION FOR HEALTHFUL LIVING

1. 65% of sickness and burden of illness in our community is due to prevailing insanitary conditions; mainly due to improper disposal of human Excreta.
2. World have experienced,
  - pandemic of cholera, where more than 70,000 lives were lost.
  - Epidemic of Jaundice at Delhi, Madurai (South India)
  - Epidemics of Polio at Bombay, Gujarath, Rajasthan, Uttar Pradesh, Delhi and Tamil Nadu are few clear cut examples of faecal bome diseases.
3. Continued prevalence of these diseases all over India; and presence of high intestinal helminths load further adds to the misery.
4. Now let us look at the mechanism of causation of a disease process. The factors involved are known as epidemiological Triad. - Agent, Host and Environment.
5. The following are the important diseases transmitted through ingestion:-

VIRAL	BACTERIAL	PROTOZOAL	HELMINTHIASIS
Jaundice Polio	Typhoid Cholera Dysentry Diarrhoea	Amoebiasis Giardiasis	Round worm Pin worm Whip worm

6. A living human being harbouring infection either clinically suffering (case) or not showing symptoms (carrier) is known as the reservoir of infection. Human faeces containing the infective agent is known as the source of infection. The material that carries the infection is known as the vehicle of infection.

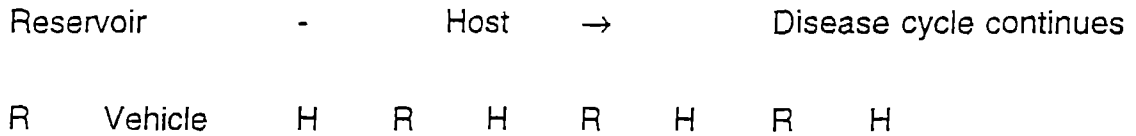
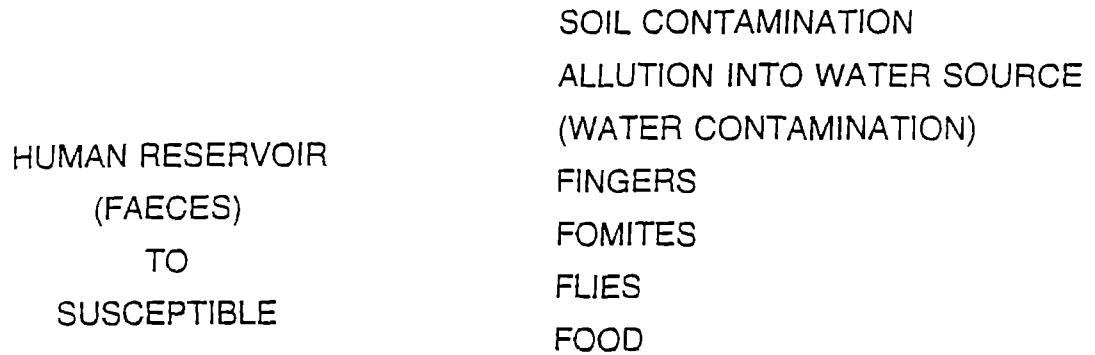

**WHAT IS THE ANSWER? IT IS SANITARY BARRIER CREATION-SANITARY LATRINE AND SANITARY DISPOSAL OF SEWAGE.**

\*\*\*\*\*

EPIDEMIOLOGICAL  
TRIAD

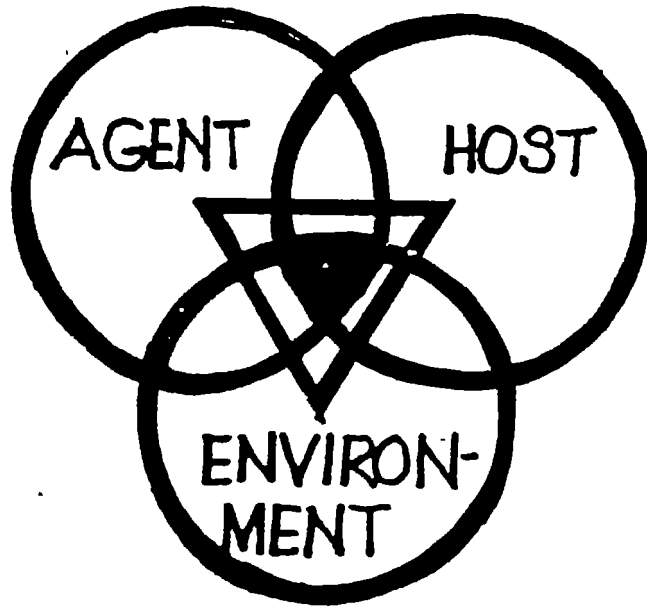

# TRANSMISSION OF FAECAL BORN DISEASE

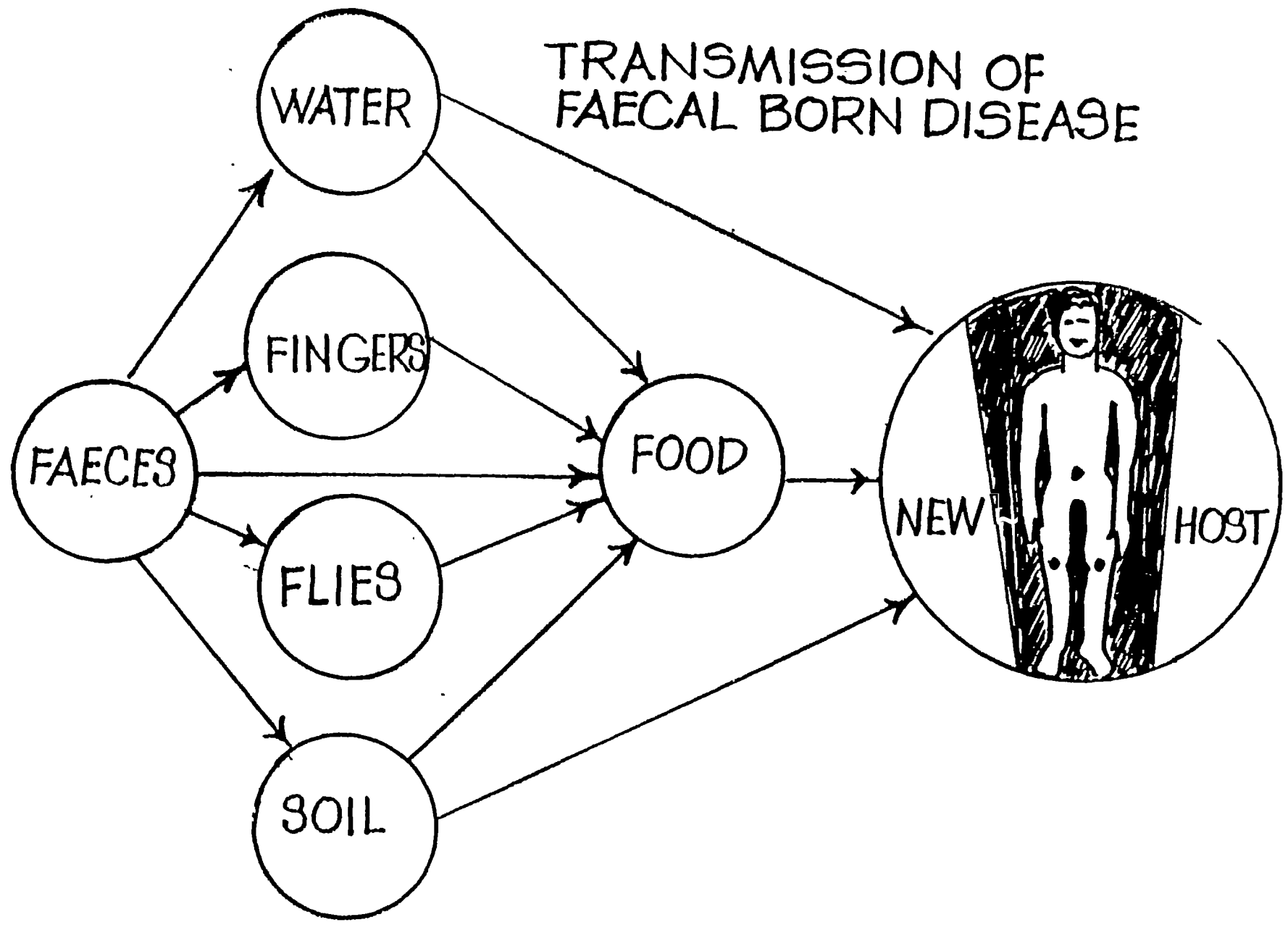

34

# SANITARY BARRIER FOR FAECAL BORNE DISEASES

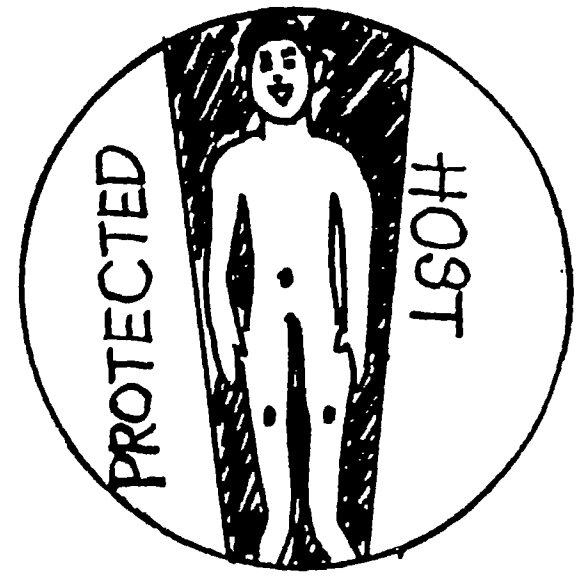
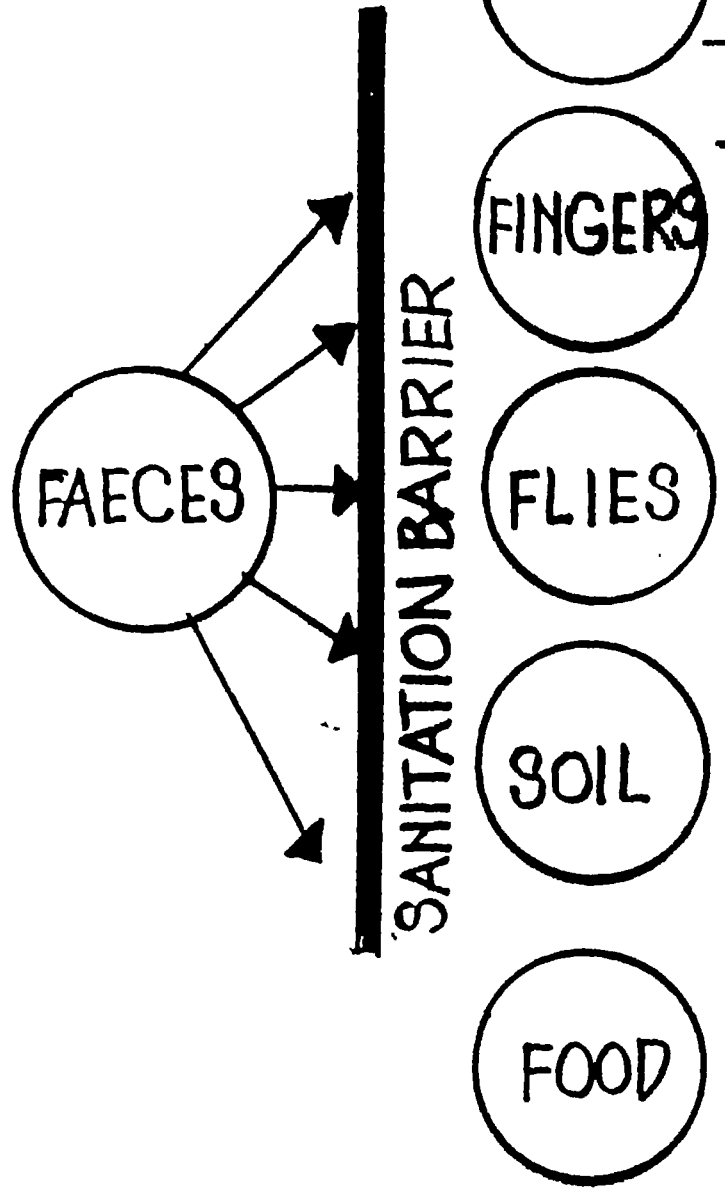



## SANITARY DISPOSAL OF HUMAN EXCRETA

### *FAECAL BORNE HAZARDS*

- \* Human Excreta is a source of many infections
- \* It contaminates soil and water sources
- \* It emits unbearable smell
- \* It propagates fly breeding
- \* It attracts pigs
- \* It harbour millions of pathogens
- \* Flies carry pathogens to food
- \* Contaminated food by ingestion leads to diseases

### *OBJECTIVES*

- \* It is an immense need as the first priority to dispose off the Human excreta by an adequate sanitary method without any hinderance to health of the community.
- \* The system evolved should not be accessible to flies, insects and animals (pigs)
- \* The system should not contaminate the surface and ground water sources.
- \* The system should be free from foul smell and unsightly condition.
- \* There should be no handling of fresh excreta.
- \* The methods evolved should be very simple and economical both in construction, operation and maintenance aspects.
- \* The system evolved should provide privacy and convenience even to the children at all seasons.
- \* The system evolved should not require the services of scavengers at all.

\*\*\*\*\*

# DETAILS OF PAN AND TRAP

ALL DIMENSIONS

IN MM

SCALE: 1:80

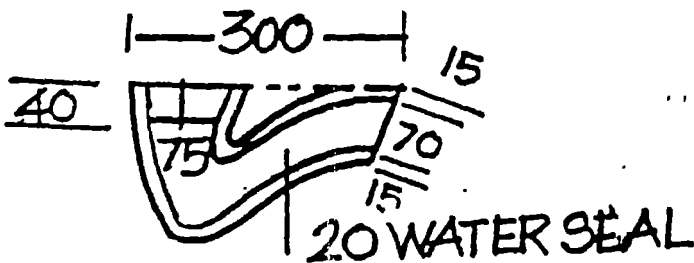
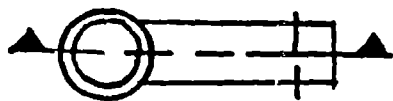
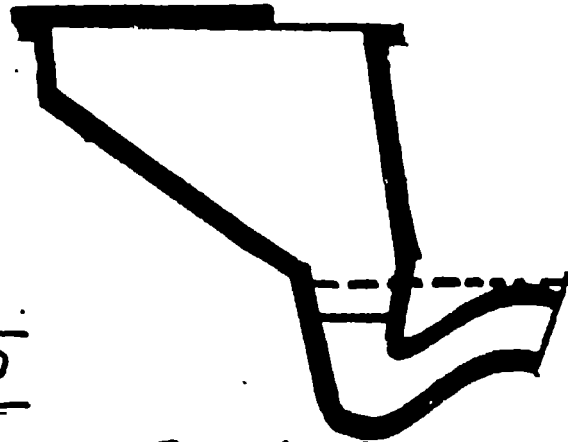
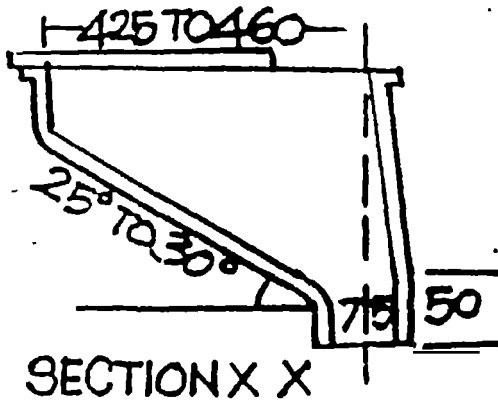
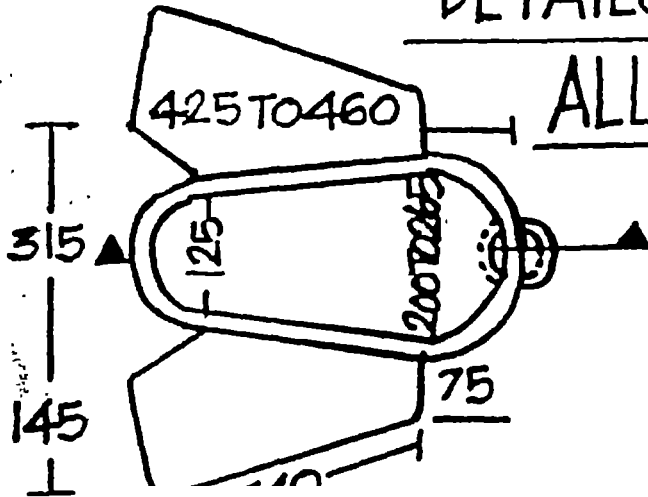

P-TRAP SECTION A-A

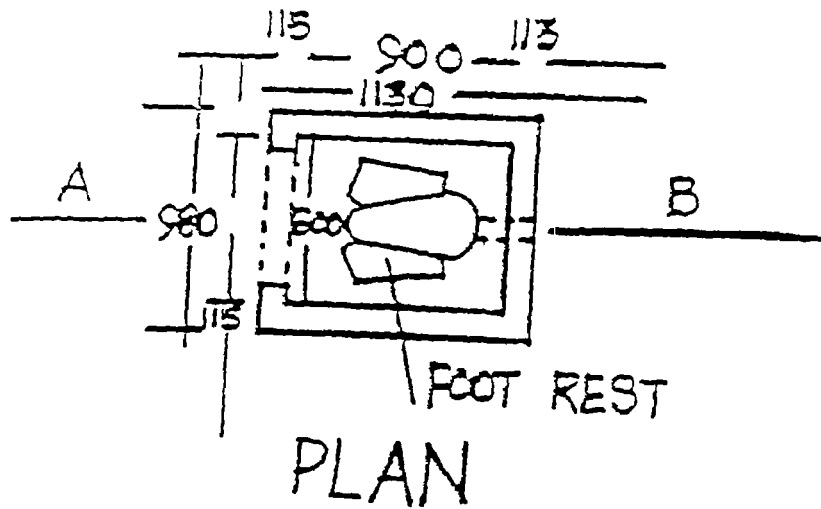

20 MM CEMENT CONCRETE  
1:2:4 FLORING OVER  
75 MM THICK  
C.C. 1:6:12

BRICK WORK IN CEMENT  
MORTAR  
1 CEMENT & 6 SAND

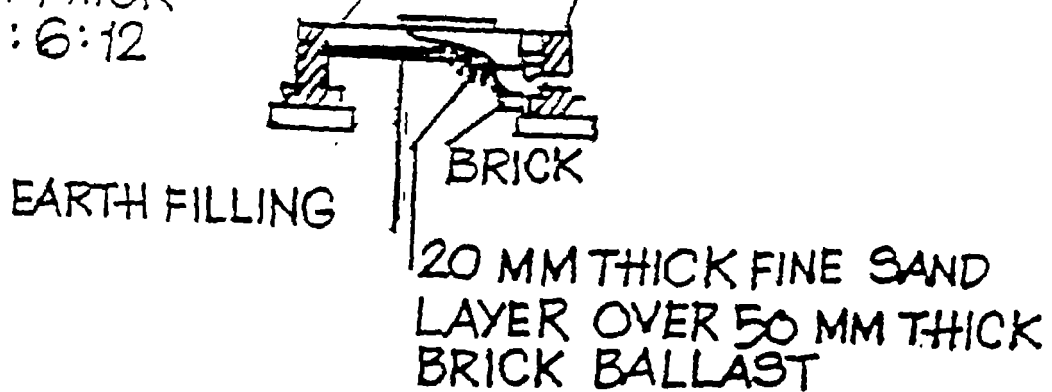

SECTION ON AB

ALL DIMENSIONS IN MM

DETAILS OF FOUNDATION AND  
PLINTH OF SUPER STRUCTURE FOR  
LATRINE

DIMENSIONS IN MM

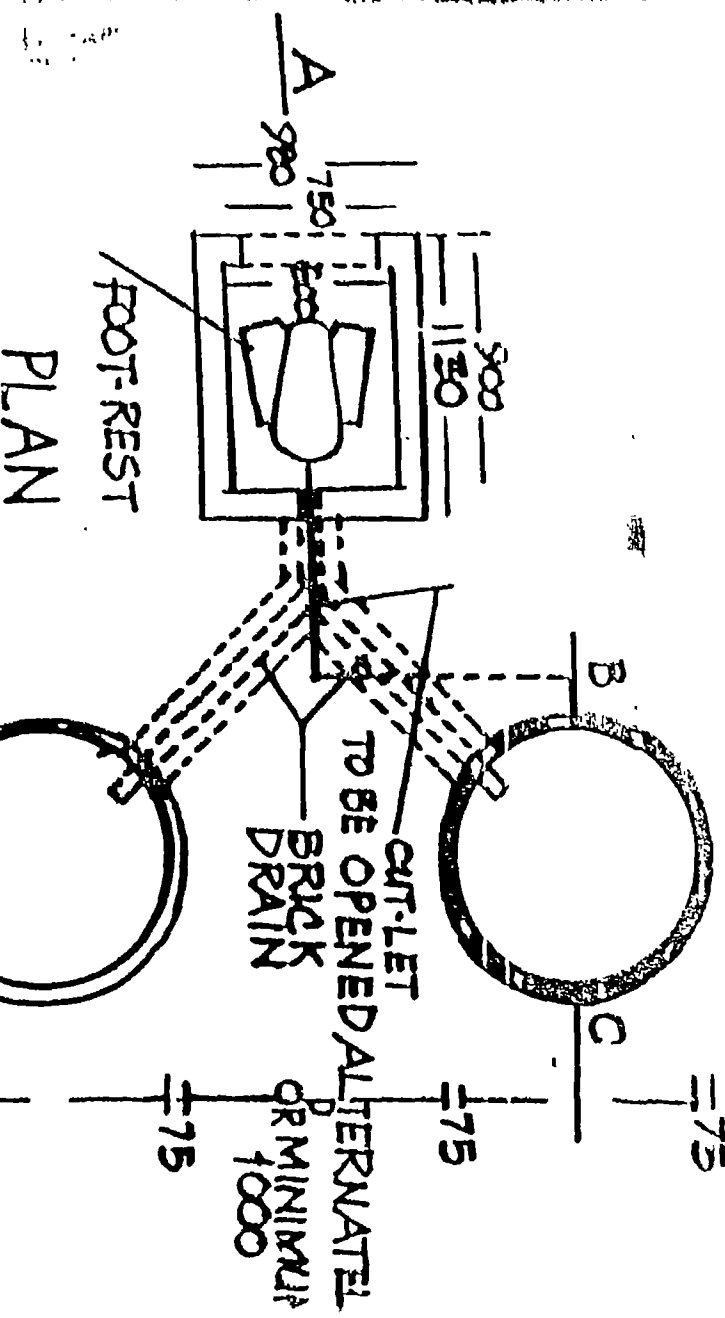

5 MM.TH. CEMENT CONCRETE  
 2:4 OVER 75M/M  
 H.C.C. 1:6:12

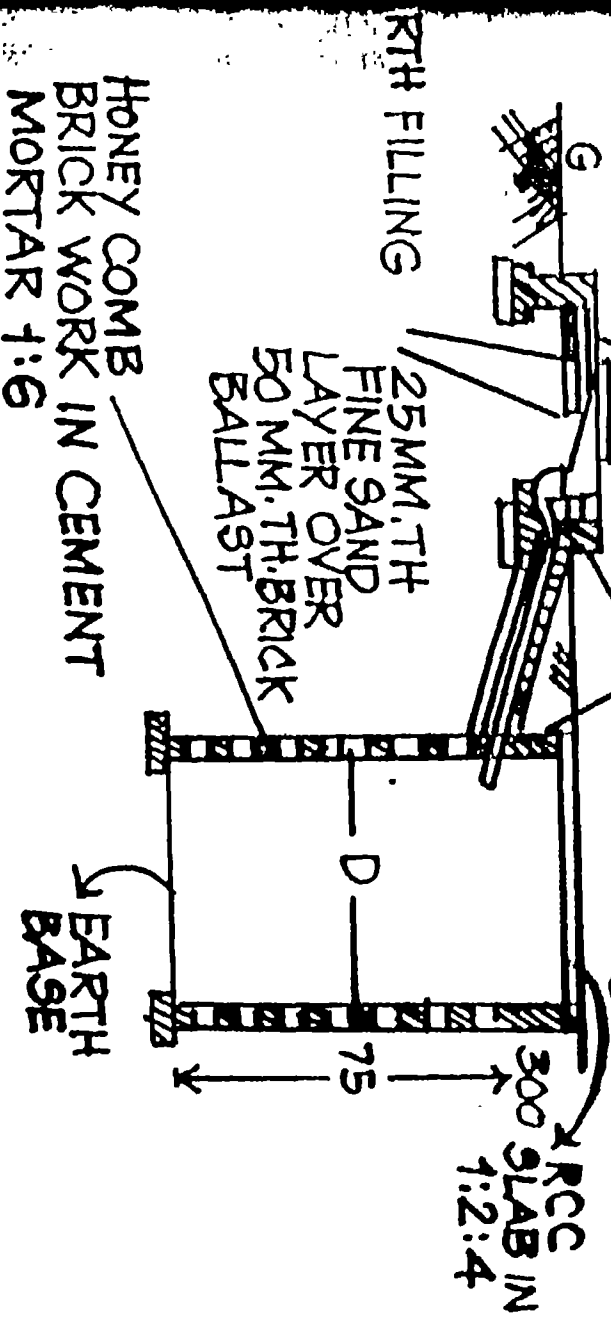

DESIGN OF LOW-COST WATER-SEAL  
 LATRINE FOR PITS WITHIN THE

PREMISES  
 DIMENSIONS IN MM

# LEACH PIT- DETAIL

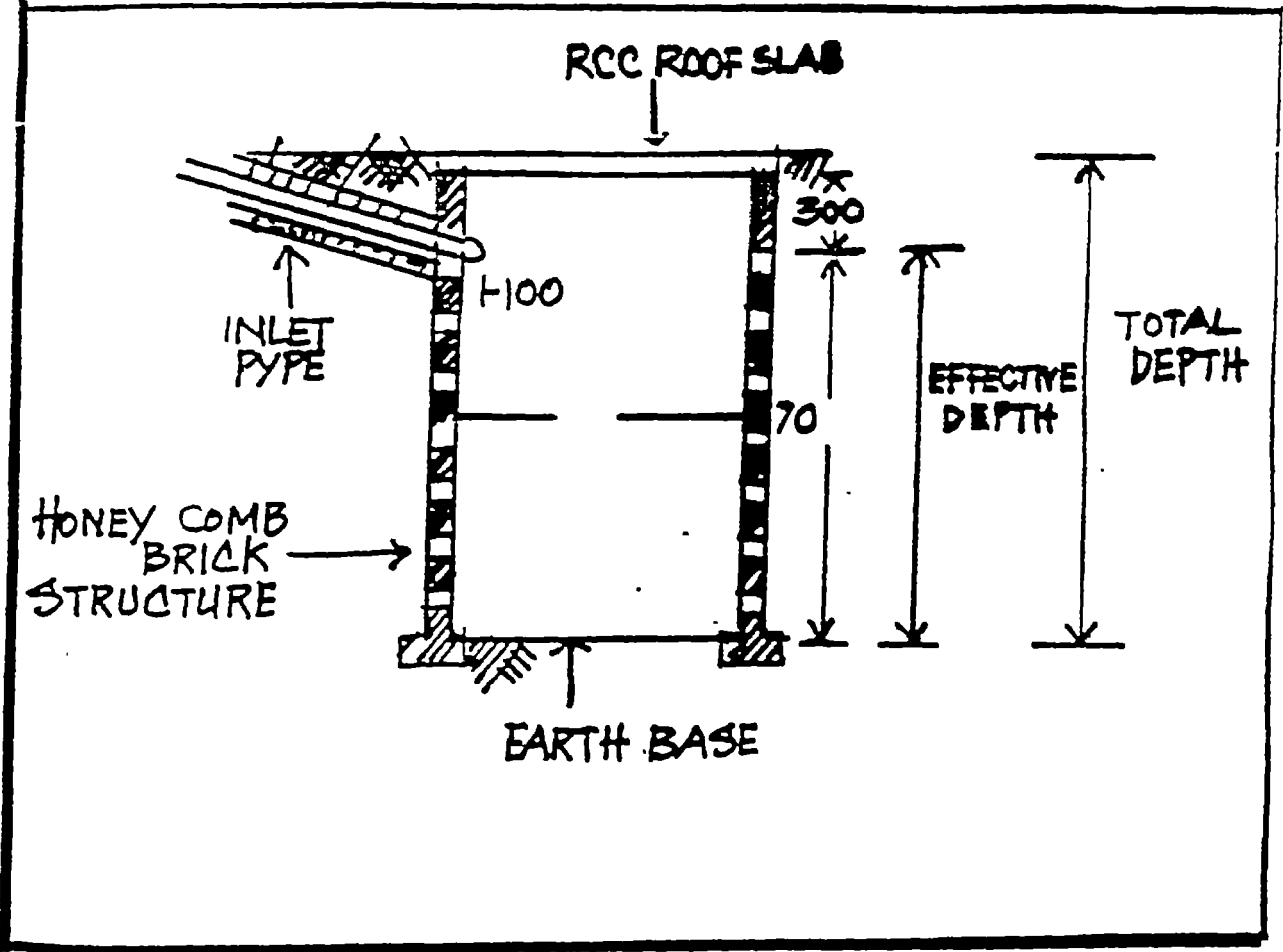

DIMENSION IN MM

7 NOS 6MM Ø BARS AT  
150MM CENTERS  
BOTHWAYS

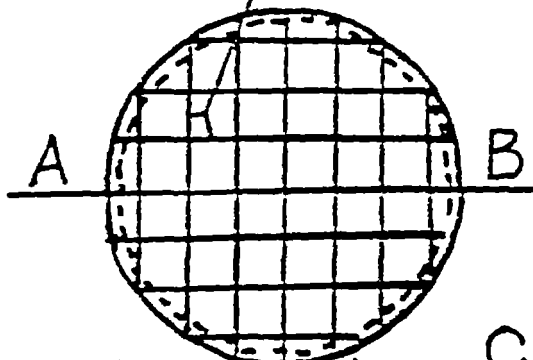

PLAN (5USERS)

8 NOS 6MM Ø BARS  
AT 150MM CENTER  
BOTHWAYS

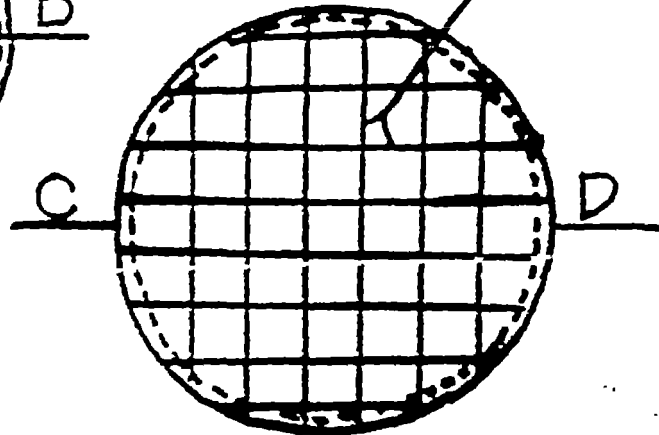

PLAN (10USERS)

9 NOS 8 & 6MM Ø BARS  
AT 150MM CENTERS  
BOTHWAYS

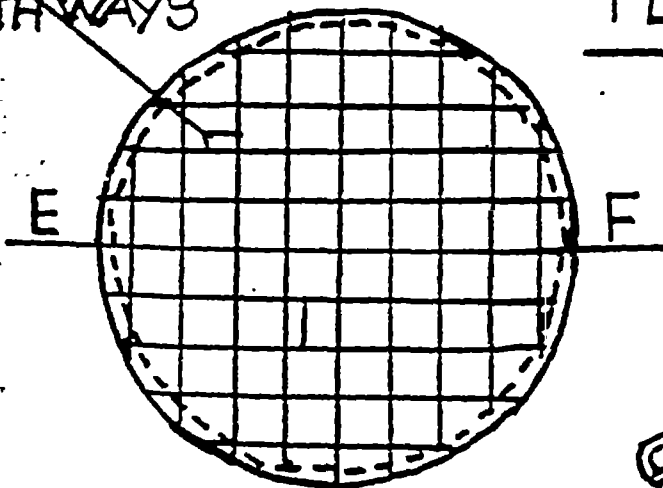

PLAN (15USERS)



SHOWING  
REINFORCEMENT BAR  
BENT UP TO FORM  
LIFTING HANDLE

DETAILS OF R.C.C. SLAB  
FOR LEACH PITS WITHIN  
PREMISES

DIMENSIONS IN MM

# LAYOUT PLAN OF LEAKING PITS IN DIFFERENT SITUATIONS

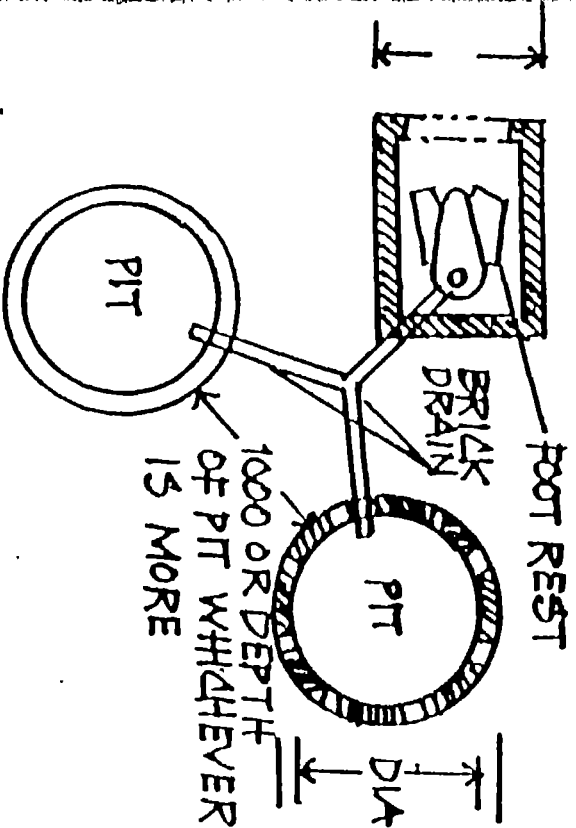
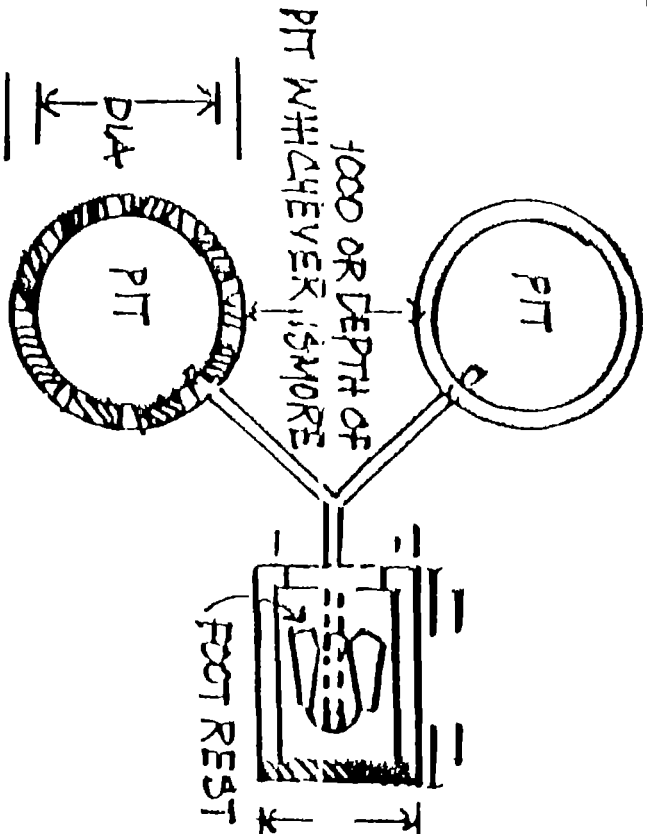

DIMENSION IN MM

# LAYOUT PLAN OF LEACHING PITS IN DIFFERENT SITUATIONS

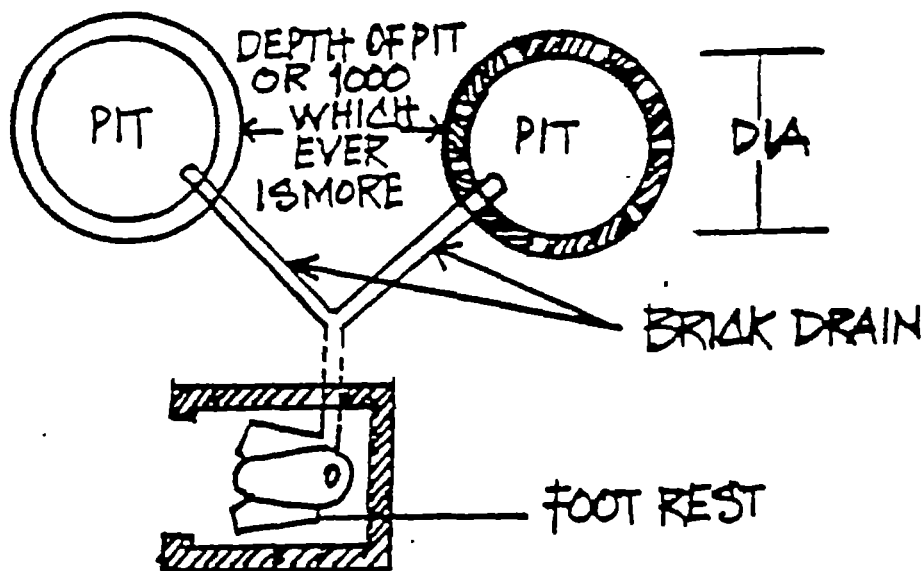
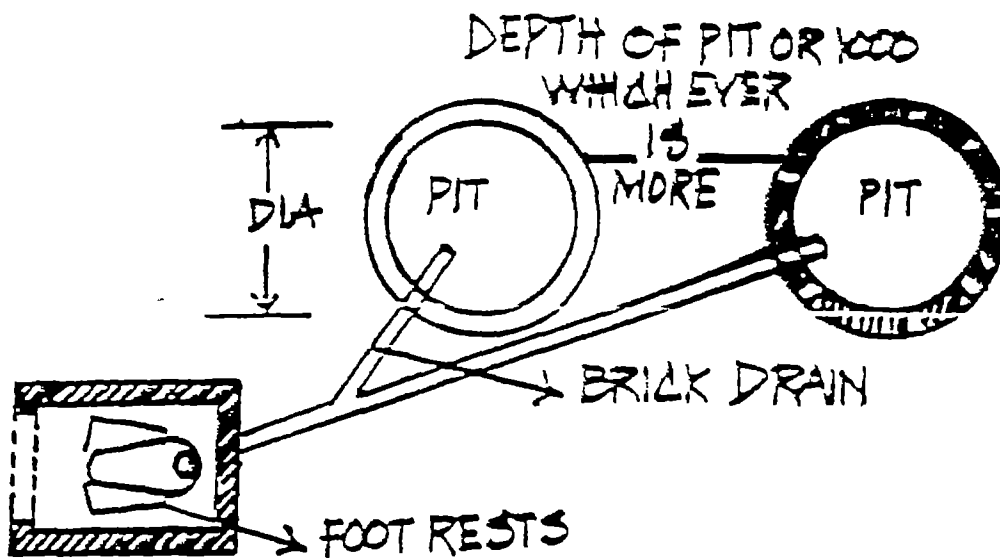

DIMENSION IN MM



CUT LET TO BE OPENED  
ALTERNATELY

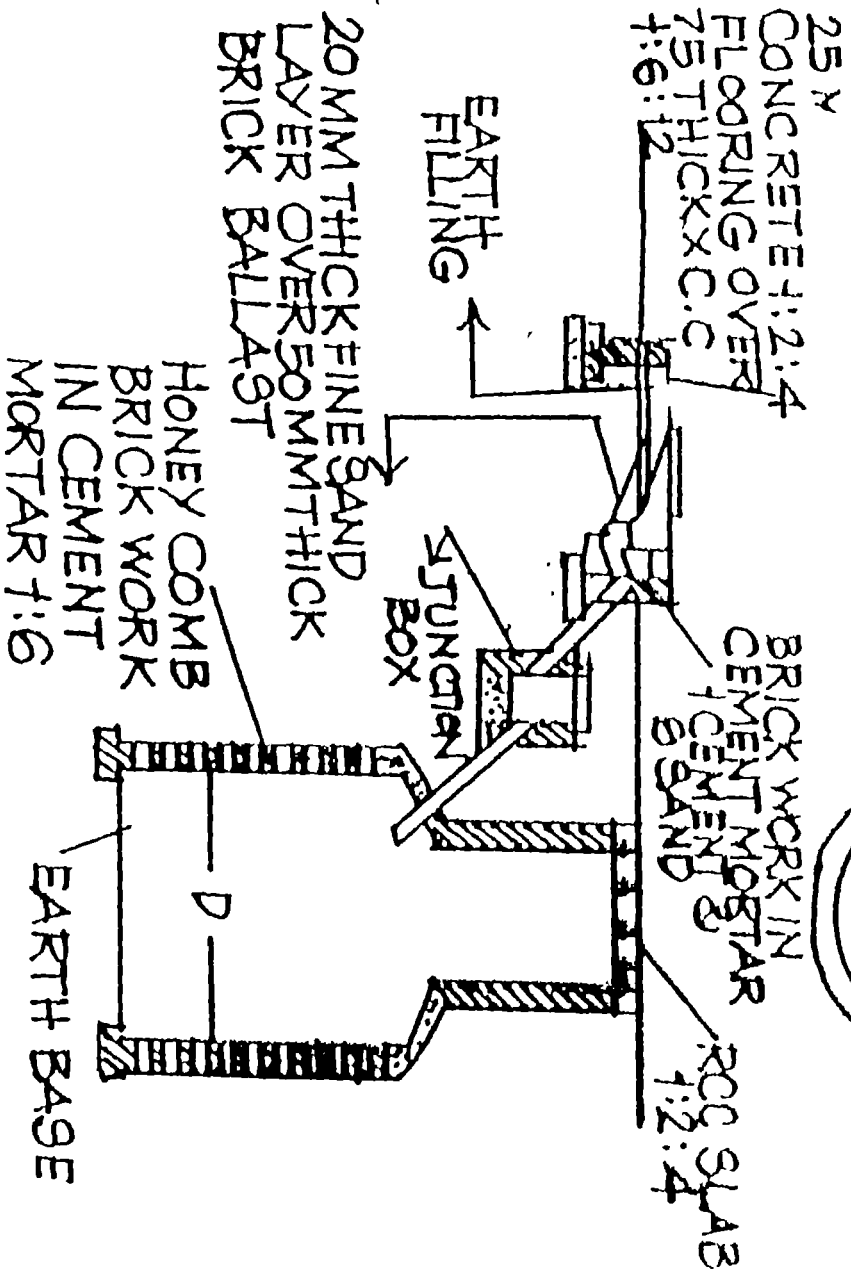
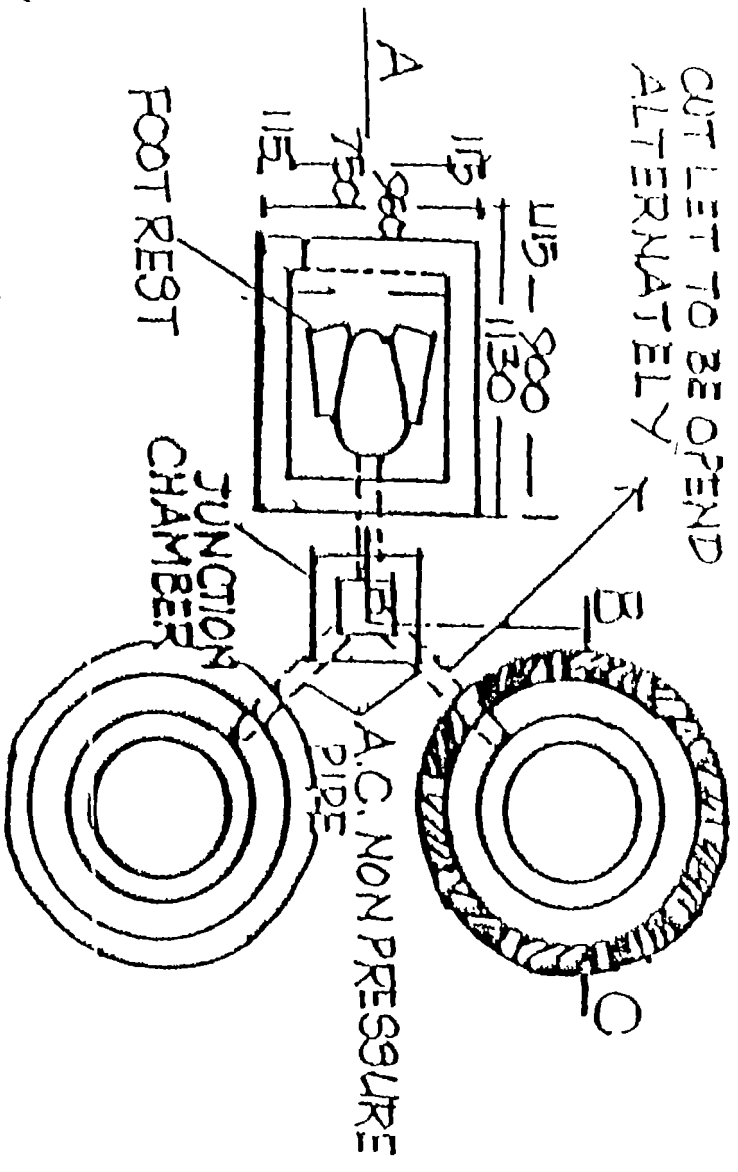

## DESIGN OF LEACH PITS

### UNDER ROAD

DIMENSION IN MM

DRY PIT

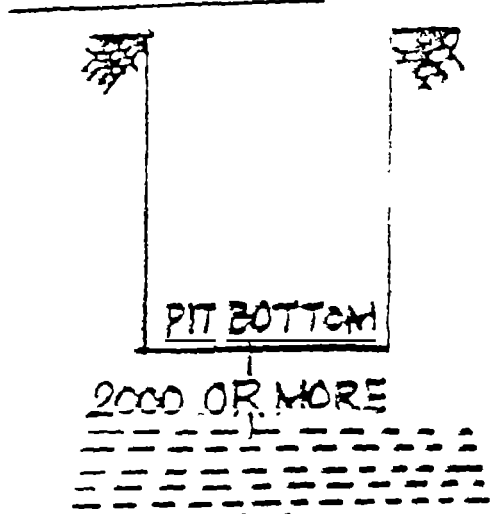

2000 OR MORE

CASE-1

DRY PIT

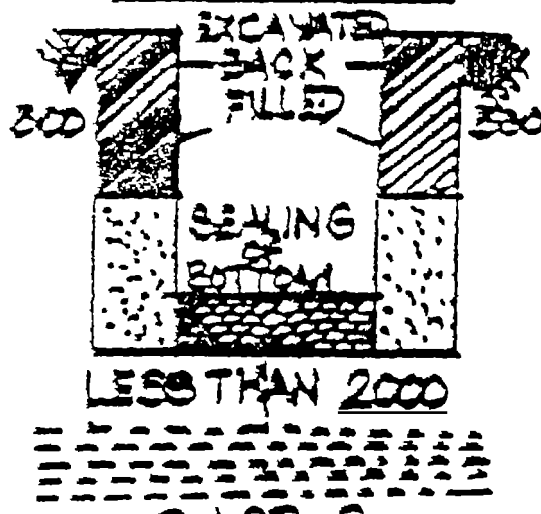

LESS THAN 2000

CASE-2

WET PIT

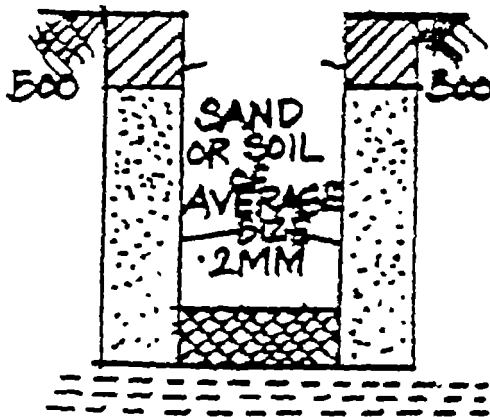

CASE-3

WET PIT

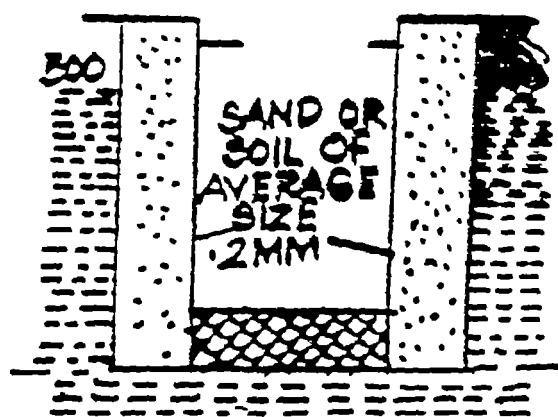

CASE 4

DIMENSIONS IN MM

# SANITARY LATRINES

The required objectives for the hygienic disposal of human excreta is fulfilled by a sanitary latrine - As it acts as a sanitation barrier and prevent the transmission of faecal borne diseases. The designing strategies isolate faeces and thereby prevent the pathogens from entering into the new host.

## SANITATION SYSTEM IN INDIA

The systems practiced in India presently are:

1. Connecting the toilets to sewerage system, where sewerage system is available.
2. Connecting the toilets to septic tanks or leach pits - where sewerage system is not available.

## CONNECTION TO SEWERAGE SYSTEM

At present sewerage system is in existence in some major towns only that too with partial coverage. Chances of providing sewerage scheme to the unsewered towns in the near future is remote: as it involves high cost of installation and time consuming. Also the system requires large quantity of water for flushing. Alternatives to un-sewered areas is found imperative.

## CONNECTION TO SEPTIC TANK

Effluent from septic tank is potentially hazardous and hence should not be connected directly to open drain as it may give room to mosquito breeding and

create risks to health. The septic tank requires additional units for the disposal of effluent either by a soak pit or by a dispersion trench.

### ***DISADVANTAGES***

- It involves periodic removal, treatment and disposal of the accumulated liquid sludge.
- Cost-wise the system is expensive. The system also requires plentiful water for flushing.

### ***CONNECTION TO LEACH PITS (Pour flush toilets)***

The pour flush toilet is a much cheaper sanitation technology. This needs only 2 to 3 litres of water per use. The water seal is hygienic to that of a conventional cistern flush toilets. There are two general type of Pour Flush Toilets.

1. Single pit pour flush toilets.
2. Double pit pour flush toilets.

Double pit pour flush toilets provides permanent facility and can be used without interruption for pit emptying or for relocating.

\*\*\*\*\*



# COMMUNITY MOBILIZATION AND PARTICIPATION

## *COMMUNITY*

A Social group determined by geographical boundaries and with common values and interests. The members know and interact with each other and create certain norms, values and social institutions

Whenever the members of any group small or large live together in such away that they share nor this or that particular interest, but the basic conditions of common life, one call that group a community. -MACIVER and PAGE.

## *COMMUNITY PARTICIPATION*

It is a social process in which specific groups with shared needs living in a defined geographical area actively pursue identification of their needs, take decisions and establish mechanisms to meet them" -WHO.

## *WORKING WITH THE COMMUNITY*

Every person who is trained should be sound in the technical and construction knowledge of this programme and should feel himself as a part of the community and most work closely with the community and with other community grass route level workers in the area.

## *IDENTIFYING COMMUNITY LEADERS*

In every rural community there are formal and informal leaders. They can help you to get the support of the whole community for the successful implementation of household, rural, lowcost, water seal latrine programme.

## **METHODS OF SELECTING COMMUNITY LEADERS**

1. Interview the formal of official leaders e.g., School Teacher, Post master, Village Administrative Head etc., Obtain from them the names of men and women whom they think are influential in the community and who can represent various community groups.
2. Observe which persons in the community are frequently consulted by the people to seek advice or assistance.
3. Also interview the head of every 3rd, 5th or 10th family - according to the size of the community. Get the opinion of the head of the family as to whom his family would like as a leader in the community. The names most frequently mentioned are identified as community leaders.

It is most important that these community leaders know in depth the objectives of the health programme, the details of each component and How it is to be implemented. So that they can interact meaningfully with the community.

### **Training of Community Leaders**

- Plan orientation training for the community leaders with the available motivated people locally.
- Work out the objectives and contents of the training programme, role of the each leader involved in the Training Programme and also required training materials including audio visual communication aids.
- Fix up a venue of the Training Programme, date and time suitable to the community leaders through discussion and preplanning.

- Discuss with the community leaders various health problems that are existing in the community and the remedies.
- Create opportunity for the Community Leaders to discuss among themselves in small groups regarding how the sanitary latrine programme could be implemented in their area.
- Clarify all the doubts of the community leaders with proper information concerning the aspects of the sanitation programme.
- Explore the available resources from the leaders in the community and how best they could be utilised in the execution of the programme.
- \* Decide upon the role and responsibilities of every community leader in the implementation of the programme in their area.
- \* Allot specific role and specific area for each, if leaders are more than one.
- Discuss with the leaders the different methods of educating and motivating the entire people in their area to understand and accept the programme.
- \* All the time maintain a cordial relationship with all the community leaders. Do not become involved in political factions and feuds.



---

# GROUP INTERACTION & EDUCATION

— CORRECT INFORMATION GIVEN



52

## CONDUCTING HEALTH EDUCATION ACTIVITIES

Health education is an important tool to practice community Health programme. A great deal of ill-health in a community is due to mainly ignorance and illiteracy. Health education aims to bridge the gap between health knowledge and health practice of the people.

People vary so widely in their socio-economic conditions, traditions, belief and levels of knowledge so that a uniform

Hence - mixture of educational approaches are to be adopted as:-

- \* Mass educational approach
- \* Small group education approach and
- \* Individual and family education approach.

### ***MASS EDUCATION APPROACH***

The aim of mass education method is to create an awareness as well as interest among people in the programme. Intensive mass education programmes can be arranged in a systematic manner. Larger audience can be reached through certain communication media in a comparatively shorter time.

Creation of awareness about the health problem is the first and fundamental step in bringing about behavioral change among the people leading to adoption of a health programme. For example the importance and need for a household sanitary latrine had to be built in the minds of the people through various mass communication educational approaches in the community.

Examples: Public Film shows, television, radio, newspaper, magazines, posters, exhibits, campaigns, puppet shows, drama, villupattu, banners etc.,

### **Disadvantages of Mass Communication Approach**

- \* There is no possibility for face to face education. The doubts or mis-conceptions of the programme cannot be clarified.
- \* This is one way communication and real learning is not expected and final action is not anticipated.

The impact of mass education communication approach has to be supported and followed by other educational methods i.e., group education and family and individual education.

### ***SMALL GROUP EDUCATION APPROACH***

- \* A group of persons (6 to 20) meet together and educational programme is conducted.
- \* The small group education approach provides opportunity for the participants 'Face to face interaction'.
- \* It is based on the principles of Group dynamics under which the members of the group are made to think, discuss and decide about the execution of a health programme in their community and also follow-up procedures and final decisions and responsibilities of the members are taken. The small group education approach enables the participants to learn more clearly about the programme to express their opinions and dispel their doubts and misconceptions about the programme.

## ***EDUCATIONAL AIDS***

Flash cards, Film Strip, Flip Chart, Slides, Models, Charts, Pictures, Photos, Demonstrations, etc.,

## ***INDIVIDUAL AND FAMILY EDUCATION APPROACH***

Effective inter-personal communication can be rendered through this method. Provides more personal contact and face-to-face discussion and flexible enough to be adopted to the individual needs. Helps to reach deeper in to the attitudinal and motivational core of the individual.

In the sanitary latrine programme the behavioral change is aimed at the family as a whole and not directed towards anyone member alone. The family should therefore be the educational target for change of attitude and behaviour.

## ***IMPORTANCE OF COMMUNITY EDUCATION ON SANITARY LATRINE***

### ***PEOPLE ARE TRADITIONALLY AND CULTURALLY USED TO OPEN FIELD DEFECATION***

- \* Only very few less than 2 % use sanitary latrine in villages.
- \* People in the rural areas resist change since they feel that the existing practice-open field defecation is the proper one.

### ***PEOPLE HAVE A BAD IMAGE ABOUT THE LATRINE***

- \* Since most of them would have seen misused and badly maintained public toilets.

## ***EDUCATIONAL AIDS***

Flash cards, Film Strip, Flip Chart. Slides. Models, Charts, Pictures. Photos. Demonstrations. etc.,

## ***INDIVIDUAL AND FAMILY EDUCATION APPROACH***

Effective inter-personal communication can be rendered through this method. Provides more personal contact and face-to-face discussion and flexible enough to be adopted to the individual needs. Helps to reach deeper in to the attitudinal and motivational core of the individual.

In the sanitary latrine programme the behavioral change is aimed at the family as a whole and not directed towards anyone member alone. The family should therefore be the educational target for change of attitude and behaviour.

## ***IMPORTANCE OF COMMUNITY EDUCATION ON SANITARY LATRINE***

### ***PEOPLE ARE TRADITIONALLY AND CULTURALLY USED TO OPEN FIELD DEFECATION***

- \* Only very few less than 2 % use sanitary latrine in villages.
- \* People in the rural areas resist change since they feel that the existing practice-open field defecation is the proper one.

### ***PEOPLE HAVE A BAD IMAGE ABOUT THE LATRINE***

- \* Since most of them would have seen misused and badly maintained public toilets.

### ***PEOPLE FEEL LATRINE IS COSTLY***

- \* Latrine construction is a costly affair.
- \* Only rich people can have a latrine.
- \* It is needed only for the city dwellers.
- \* Not aware of the low cost sanitary types which cost less, require less space and less water.

### ***LATRINE IS GIVEN***

- \* Low value
- \* Low priority

### ***PEOPLE ARE NOT AWARE***

- \* That indiscriminate defecation is the root cause for many diseases.
- \* That effective solution is latrine use.

### ***PEOPLE DO NOT REALISE THE ADVANTAGES OF SANITARY LATRINE***

- \* Improves sanitation.
- \* Helps to control faecal borne diseases.
- \* Convenience.
- \* Privacy.
- \* Can be used at any time-during any season.
- \* Both old and young can use.
- \* Manure value of excreta is not lost.
- \* Symbol of status and prestige.

### *THE PRESENT PRACTICE HAS GOT NO SOCIAL ACCEPTANCE*

- \* Open defecation is looked upon as a personal matter and not as a social problem.
- \* Many do not consider it as a health problem at all but consider the open defecation as a way of life.

### *PEOPLE NEED*

- \* Information about sanitary latrine-availability of materials.
- \* Guidance as how to get materials.
- \* Persons to be contacted, availability of subsidy etc.,
- \* How to construct, how to use and maintain it.
- \* Assistance in all possible way to rectify defects.
- \* How to switch over to the second pit when the first latrine gets filled up.
- \* Follow up by the health worker or guide so that latrine are properly used and maintained.

TABLE NO. 4

## Comparative Statement of Community Participation &amp; Use of Toilets

Category	Village 'A'	Village 'B'	Village 'C'	Village 'D'
1. People's participation	25%	50%	Nil	100%
2. Leadership role	Not satisfactory	Fair	Nil	Good
3. Health Education	Mass method	Mass Method Group Method	Nil	Mass method Group Method, Individual contact
4. Usage of sanitary latrines	30%	60%	Nil	100%

Please Note: In a Community where a) People's participation b) Leadership role and c) Health Education are involved in high degree with complete form the acceptance and use of sanitary latrine by the people is 100 %.



**PEOPLE NEED**

- \* Education (Concerned)
- \* Awareness (Creation)
- \* Knowledge (Imparted)
- \* Faith (Developed)
- \* Success Stories (Compartions)
- \* Eye Witness (Belief)
- \* Trail on hte Subject
- \* Attitudinal Change
- \* Strict Adhereance
- After chage

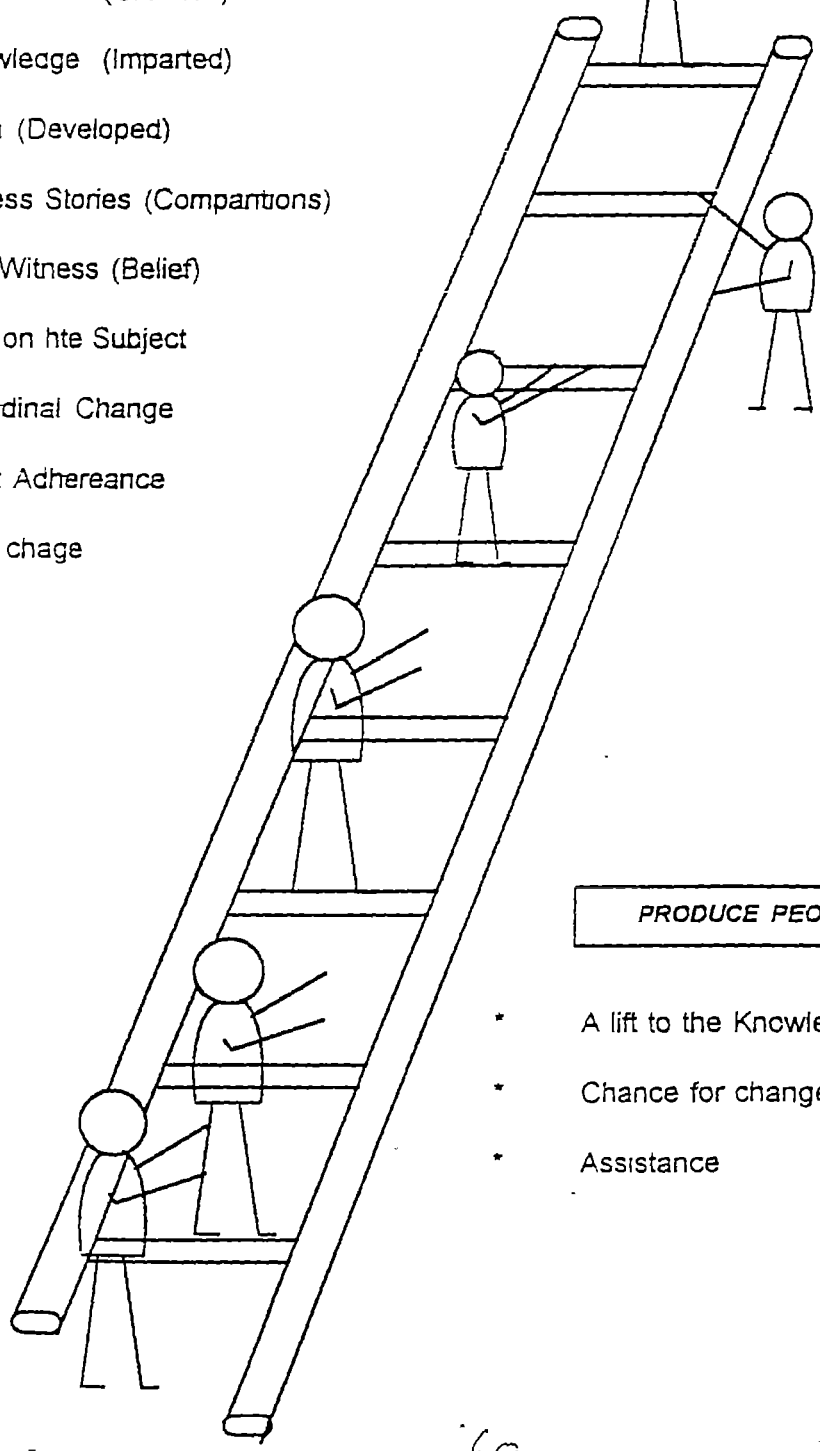
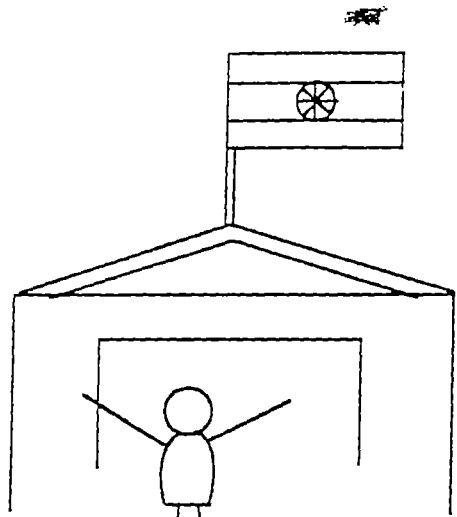

**PRODUCE PEOPLE**

- \* A lift to the Knowlege and skill
- \* Chance for change of Attitude
- \* Assistance

# OBSTACLES IN PROMOTING RURAL LATRINE PROGRAMME

## *SOCIAL AND CULTURAL*

- \* Village people who have the habit of using the open fields for defecation resist change. They find fields more convenient.
- \* Villagers who have seen a latrine, have seen it in a public place, often badly maintained. This has left an image of latrine being foul smelling; a place for breeding flies; dirty and unhygienic.
- \* Most village people do not know faecal borne diseases can be prevented by the use of latrines.
- \* Many villagers feel latrine use restricts social contacts of women and creates problems of privacy.

## *CONSTRUCTIONAL*

Village people say:

- \* Construction is expensive and difficult.
- \* They do not have enough space.
- \* They do not have enough water.
- \* Maintenance is difficult.
- \* Faecal matter is lost instead of fertiliser.
- \* Faecal matter is visible.
- \* If a latrine is wanted, they do not know where to go for the materials; how to construct one and have to maintain it properly.

*ORGANISATIONAL*

- \* Lack of Well trained technical personnel.
- \* Less concentration by workers on the latrine problem.
- \* Inadequate workers in attacking problem.
- \* Inadequate Careful supervision and guidance of field workers.
- \* Inadequate Administrative procedure to ensure quick supply of materials where needed.
- \* Inadequate budget provision.

\*\*\*\*\*

100



100



