

Seminar on
**Management of the Existing Water and Sewage Treatment
Facilities and Services : Case Studies and Analyses of
Proposals for Future Development**

8-10 February - 2001

Venue
Conference Hall, Youth Hostel (International) Complex,
Chakratirtha Road, Puri, Orissa
(Opposite B. N. R. Hotel)



Organised by
Institution of Public Health Engineers, India
CK-58, Salt Lake City, Kolkata-700 091

Co-sponsored by
Orient Rubber Products
Electrosteel Castings Ltd.
M. N. Dastur & Company Ltd.
HUDCO

LIBRARY IRC
PO Box 93190, 2509 AD THE HAGUE
Tel.: +31 70 30 689 80
Fax: +31 70 35 899 64

MARCODE: 17552
LE.

**Seminar on
Management of the Existing Water and Sewage Treatment
Facilities and Services : Case Studies and Analyses of
Proposals for Future Development**

8-10 February - 2001

Venue

**Conference Hall, Youth Hostel (International) Complex,
Chakratirtha Road, Puri, Orissa
(Opposite B. N. R. Hotel)**



Organised by

**Institution of Public Health Engineers, India
CK-58, Salt Lake City, Kolkata-700 091**

Co-sponsored by

**Orient Rubber Products
Electrosteel Castings Ltd.
M. N. Dastur & Company Ltd.
HUDCO**

**Seminar on
Management of the Existing Water and Sewage Treatment
Facilities and Services : Case Studies and Analyses of
Proposals for Future Development**

PROGRAMME

Venue

**Youth Hostel (International) Conference Hall,
Chakratirtha Road, Puri (Opp. BNR Hotel)**

7 February 2001 Wednesday	4 - 7 PM	Registration & Informal Get Together
8 February 2001 Thursday	10 AM 10:30 AM 11:30 AM 12:00 2:00 PM 3:00 PM 4:00 PM 5:00 PM	Registration Inauguration Tea Session — I Lunch Break Session — II Tea Conclusion
9 February 2001 Friday	9 AM 10:30 AM 11:00 AM 1:30 PM 2:30 PM 4:30 PM	Session — III Tea Session — IV Lunch Session — V End
10 February 2001 Saturday	Tours (Optional)	

CONTENTS

Page No.

Session I 08.02.2001 (12 Noon to 2:00 PM)

- | | | | | |
|----|---|-----|-----|-------|
| 1. | Construction, Commissioning and Operation and Maintenance of 20 MLD Sewage Treatment Plant at Hussain Sagar Lake, Hyderabad along with Performance Evaluation of the STP— A Case Study
— <i>K. C. Waghray, B. Mukesh and P. Rajendar</i> | ... | ... | 1-11 |
| 2. | Technology Innovation in Waste Water Treatment
— <i>S. Vaidyanathan</i> | ... | ... | 12-18 |
| 3. | Economical Treatment of Sewage by Soil Scape Process
— <i>Sandeep Joshi and Sayali Joshi</i> | ... | ... | 19-21 |
| 4. | Soil Scape Process in Comparison with Conventional Technologies
— <i>Sandeep Joshi</i> | ... | ... | 22-24 |
| 5. | The Upgradation of Industrial and Domestic Waster Water — A Case Study
— <i>T. K. Bose</i> | ... | ... | 25-29 |
| 6. | Performance Evaluation of Oxidation Pond at R.E.C. Campus, Hamirpur
— <i>Moti Ram Sharma</i> | ... | ... | 30-33 |

Session II 08.02.2001 (3:00 to 4:00 PM)

- | | | | | |
|----|---|-----|-----|-------|
| 1. | In-Situ Treatment of Sewage in Urban Storm-Water Drains
— <i>Mrs. Almitra H. Patel</i> | ... | ... | 34 |
| 2. | Calcutta Drainage — A Problem
— <i>Tarit Kumar Mukhopadhyay</i> | ... | ... | 35-36 |

Session III 09.02.2001 (9:00 AM to 10:30 PM)

- | | | | | |
|----|--|-----|-----|----|
| 1. | Experience on Use of Duckweed in Low Cost Waste Water Treatment
— <i>J. N. Shome, S. K. Neogi and A. K. Baishya</i> | ... | ... | 37 |
| 2. | Upflow Anaerobic Sludge Blanket (UASB) Reactor for Sewage Treatment in Large Housing Project
— <i>J. N. Shome, S. K. Neogi and A. Baishya</i> | ... | ... | 38 |

Session IV
09.02.2001
(11:00 AM to 1:30 PM)

1.	Impact of The Ganga Action Plane Phase 1 on the water quality of The River Ganga at Varanasi — R. R. Narayanan, Kamal Tewari, P. K. Mishra and B. N. Rai	39
2.	Water of Sewage Treatment Facilities in Varanasi : Present Status and Scope for Improvement — R. R. Narayanan, K. B. Tewari, B. N. Rai, P. K. Mishra and A. K. Jedey	40-42
3.	Riverbank Filtration for Improved Quality : An Option During Plan Expansion — Chittaranjan Ray	43-45
4.	Water Conservation Scheme by Proper Treatment and Recycling in Indian Steel Plants — Dr. Ranajit Chowdhury	46-50
5.	Concept of Rejuvenation and Conservation of Hussain Sagar Lake, Hyderabad— A Cast Study — K. C. Waghray, B. Mukesh and P. Rajendar	51-54
6.	Modern On-Site Water Quality Monitoring Instrumentation — G. B. Diwakar	55-59

Session V
09.02.2001
(2:30 PM)

1.	Safety in Chlorination Plant — Dilip Amrut Dongare	60-65
2.	Electrochlorination System - An Welcome Change — Samiran Kr. Ghosh	66-68

N. B. : The article "Are we Fair to our Filter ?" by B. B. Panda, Ex. Chief Engineer, PHED, Govt. of Orissa shall be distributed when available.

Construction, Commissioning and Operation and Maintenance of 20 MLD Sewage Treatment Plant at Hussain Sagar Lake, Hyderabad along with Performance Evaluation of the STP

— A Case Study —

K. C. Waghray

General Manager(E), World Bank Constn. Divn. No. 1
H.M.W.S. & S. Board, S. R. Nagar, Hyderabad

B. Mukesh

Manager (E), World Bank Constn. Divn. No. 1
H.M.W.S. & S. Board, S. R. Nagar, Hyderabad

P. Rajendar

Manager (E), (CDC), World Bank Constn. Divn. No. 1
H.M.W.S. & S. Board, S. R. Nagar, Hyderabad

Introduction

The famous Hussain Sagar Lake is located in the heart of the twin cities of Hyderabad and Secunderabad and it divides the twin cities. The lake water was used as drinking water source until 1930's. By that time due to unplanned industrialization and urbanisation of the catchment area of about 240 Sq. Mt., the lake water is polluted and thus the blue water gradually changed to a brownish black in colour and the lake became biologically dead by 1990's. The aquatic life including fish were killed.

SAILENT FEATURES OF LAKE

Volume	: 28.60 million cubic metres
Surface area	: 5.70 million square metres
Average depth	: 5 M (1 to 12 M)
FTL	: 513.43
MWL	: 514.93
Tank Bund Level	: 518.16 M
Vents outlet	: 2 Sides, North-Eastern side and South-Eastern side

The lake receives its inflows from four nalas. The average annual rainfall of the city is 75 CM and the average run-off in to the lake is about 30 million cubic metre. Apart from the rain water following domestic and industrial waste water enter the lake as dry weather flows.

Sl. No.	Name of the Nala	Domestic Flow in MLD	Industrial Flow in MLD	Total Flow in MLD
1.	Kukatpally Nala	55	15	70
2.	Picket Nala	6	-	6
3.	Banjara Nala	6	-	6
4.	Balkapur Channel	13	-	13
Total:		80 MLD	15 MLD	95 MLD

With an idea of Rejuvenation of Hussain Sagar lake a project namely abatement of pollution of Hussain Sagar is taken up under the World Bank funded scheme which consists of the following components of work.

1. Laying of duplicate K&S main northern side of the lake and duplicate-A on Southern side.
2. Diversion units on four major incoming nalas to divert the dry weather flows into the above said pipelines.
3. Construction of 20 MLD Sewage Treatment Plant with extended aeration process such that the domestic waste from duplicate-A main can be discharged into lake after proper treatment to maintain the hydrology of the lake.

The above project is completed by 1998 and 20 MLD Sewage Treatment Plant was inaugurated by the Hon'ble Chief Minister of A.P. on 28-5-1998. The lake water quality started improving after completion of diversion works and STP.

20 MLD Sewage Treatment Plant (STP)

A 20 MLD capacity STP with extended aeration process is constructed near Madarsa Makta area by reclaiming 2.5 hectares of lake area.

Process Selection

Four alternative processes are considered while selecting the process namely extended aeration, activated sludge process, aerated lagoon and USAB followed by lagoon.

Out of the four (4) alternatives, an extended aeration is selected as the B.O.D. removal is high i.e. from 96-98% and land requirement is less if D'canter centrifuge is erected for removal of excess sludge, though the power requirement is high.

UNITS OF TREATMENT PLANT

1. Receiving Sump
2. Receiving Chamber
3. Screen channel with manual and mechanical screen
4. Degritting tank with rake classifier
5. Flow measuring channel with flow meter
6. Drop chamber
7. Aeration tank
8. Secondary settling tank
9. D'canter centrifuge including Poly-electrolyte dosing equipment
10. Sludge pump house
11. Filtrate pumps

UNIT OPERATIONS

The domestic waste water from 1800mm dia RCC 'A' main enters receiving sump through 900mm dia RCC pipeline where 4 Nos. of 40 HP submersible pumps are installed. 2 Nos. of pumps will give 20 MLD @ 420 cum/hr/pump which means 100% standby available.

The waste water then falls to receiving chamber and passes through screens where floating matter like plastics are removed.

The grit settles in degritting tank and is removed by rake classifier mechanically. The agitator washes grit from the organic matter before rake classifier removes the grit.

The wastewater passes through Parshall flume fitted with flow meter and drop chamber before it enters aeration tank where flow is measured.

Aeration Tank

The aeration tank consists of 16 Nos. of aerators. Each aerator consists of 30 HP motor, reduction gear and impeller. The oxygen transfer capacity of each aerator is 33.5 kg/hr with a total installed capacity of 536 kg/hr. The biological treatment takes place in aeration tank.

Bacteriology of Sewage

The strength of sewage is its potentiality for producing nuisance caused by the offensive odour and the oxidisable organic matter content and is referred to as Bio-Chemical Oxygen Demand (B.O.D.). The B.O.D. is a parameter by which sewage strength is measured.

Characteristics of Sewage

1. Physical Characteristics

Odor, colour, turbidity and temperature are physical characteristics.

The septic sewage gives offensive odor of hydrogen sulphide, colour is turbid and dark resembling dirty dishwater and temperature is higher than that of the water supply because of heat added during the utilization of water.

2. Chemical Characteristics

Fresh sewage is alkaline but septic sewage is acidic and the pH varies in between 6-7. Sewage contains 0.08 to 0.1 percent solid matter in the form of suspended, dissolved, colloidal and settleable. The solids in sewage comprise of both organic and inorganic matter. The organic matter is 45% of total solids and consists of animal and vegetable matter, Sugar, starches, cellulose, fats, kitchens, laundries etc. The organic matter is 55% of solids and consists of minerals and salts such as sand, gravel, debris, dissolved salts, chlorides, sulphates etc. Besides solids, liquids, gases like H_2S , CO_2 and CH_4 due microbial action are present in sewage.

3. Biological Characteristics

Large number of bacteria and other living organisms like algae, fungi, protozoa etc., are present in sewage. Most of these bacteria are harmless to man and help in converting the organic compounds of sewage into simple stable organic and mineral compounds resulting in purification of sewage.

Some of the bacteria however, particularly pathogenic type, are harmful and cause diseases.

The bacteria useful in sewage treatment are known as metatrophic group and they are further sub-classified as aerobic, anaerobic and facultative.

Aerobic bacteria live on free oxygen of air or on the dissolved oxygen in water and convert complex organic compounds of sewage into simpler, stable and unobjective organic and mineral compounds resulting in purification of sewage for example aerobic bacteria decompose Nitrogen, Carbon, Sulphur into stable and un objectionable compounds of nitrates, carbohydrates and sulphates and this process is known as oxidation.

The decomposition of Nitrogen, Carbon and Sulphur by oxidation through the agency of the aerobic bacteria are the parts of famous Nitrogen, Carbon and sulphur cycles.

In Nitrogen cycle, the ammonia in sewage is oxidized first to Nitrites and then nitrates which are final stable compounds by aerobic bacteria.

In sulphur cycle, the hydrogen sulphide is oxidized by the aerobic action into inoffensive sulphates.

In the Carbon cycle, the organic matter containing cellulose, starch and sugar are transformed into carbohydrates.

The above principle is used in biological process in aeration tank.

In this particular plant extended aeration with 21 hours detention extending the bacteria's life upto endogenous respiration of the growth curve for high B.O.D. removal of about 95% and high-suspended solids removal is used.

For good, biological process in aeration tank a MLSS of 3000-5000 mg/l and a dissolved oxygen level of 2 mg/l are required and the same are being maintained.

SST

The SST is 42 M dia with scrapper mechanism with a detention of 2 hours 30 minutes. The settled sludge is recycled by sludge pump house and clear treated effluent is let into the lake through 600mm RCC pipeline.

Sludge Pump House and D'Canter Centrifuge:

The sludge pump house consists of wet well and dry well. The settled sludge in SST enters wet well through 450mm dia CI pipeline. 3 Nos. of 115 lps capacity centrifugal pumps are erected in dry well to pump the sludge back to aeration tank for recycling through 400mm dia CI pipeline. When excess sludge appears i.e. when MLSS exceeds 5000 mg/l in aeration tank, the sludge is also pumped to D'Canter centrifuge to separate solids and liquids. The separated sludge which is completely digested can be used readily as manure. Poly-electrolyte solution is also dosed in centrifuge using dosing equipment consisting of dosing tank fitted with agitator and dosing pump. The dosage varies in between 5 to 10 ppm depending on MLSS.

Filterate Pumps

The filtrate from centrifuge is collected in a sump fitted with 2 Nos. of 5 lps vertical pumps and pumped back to aeration tank inlet chamber.

Influent and Effluent Standards

Sl. No.	Parameter	Influent Design Valve	Effluent Standards	Annual Average of the treated effluent
1.	PH	7-8	7-8	7-8
2.	Suspended Solids	375 mg/l	30 mg/l	<26.49 mg/l
3.	B.O.D.	400 mg/l	20 mg/l	<6-8 mg/l

The influent and effluent is being analysed on daily basis for the following parameters and a graph is prepared based on monthly average for the period of April 99 to March 2000.

1. pH
2. Suspended Solids
3. B.O.D.
4. C.O.D.
5. Total Nitrogen
6. Phosphates
7. D.O. in aeration tank and SST

From the graphs for the period April 1999 to March 2000 it can be seen that all the treated effluent parameter values are well within limits as per standards.

Further the B.O.D. removal efficiency for the year is about 97.8%, but a total Nitrogen removal is about 58.9%, phosphates removal is about 59.1% and SS is about 94% which shows that the process is running effectively.

Lastly the D.O. in aeration tank is more than 2 ppm and in SST more than 4 ppm. For effective biological action in aeration tank a minimum of 1 ppm D.O. is essential.

The diversion units and STP are in operation since 2½ years and there is considerable improvement in the lake. The dark colour changed to greenish blue, millions of fish and other aquatic life re-appeared including ducks. Many types of birds are flying around the lake including swans. In short the lost glory is being regained and the lake rejuvenation has started and is nearing completion.

- Note :
1. Statement showing the Test Reports for 20 MLD STP at Hussain Sagar Lake, Hyderabad during in the year 1999-2000 (copy enclosed).
 2. Graph showing the particulars of BOD₅ Trend in 20 MLD STP (copy enclosed).
 3. Graph showing the particulars of Suspended Solids Trend in 20 MLD STP (copy enclosed).

Sl. No.	Tests	Results	
		Influent Sample Receiving Chamber	Treated Effluent Outlet Chamber of SST
I.			
1.	pH	6.92	7.45
2.	Suspended Solids, mg/l	528	29
3.	Phosphates as PO ₄ , mg/l	25	9
4.	Phosphates as P, mg/l	8.16	2.93
5.	Nitrates as NO ₃ , mg/l	8	56
6.	Total Kjeldahl Nitrogen, mg/l	39	7
7.	Total Nitrogen, mg/l	41	20
8.	C.O.D., mg/l	992	56
9.	B.O.D. for 3 days at 27°C, mg/l	450	9
II.		AT	SST
1.	Dissolved Oxygen, mg/l	2.10	3.60

Sl. No.	Tests	Results		Reduction
		Influent Sample Receiving Chamber	Treated Effluent Outlet Chamber of SST	
I.				
1.	pH	7.06	7.52	-
2.	Suspended Solids, mg/l	132	18	-
3.	Phosphates as PO ₄ , mg/l	6	2	67%
4.	Phosphates as P, mg/l	1.96	0.65	-
5.	Nitrates as NO ₃ , mg/l	5	18	-
6.	Total Kjeldahl Nitrogen, mg/l	8	1	-
7.	Total Nitrogen, mg/l	9	5	45%
8.	C.O.D., mg/l	164	20	-
9.	B.O.D. for 3 days at 27°C, mg/l	80	3	96.3%
II.		AT	SST	
1.	Dissolved Oxygen, mg/l	2.35	4.50	

Concepts of O&M

Operation & Maintenance of any installation is very important for efficient running and best results. The concepts of O&M should be:

1. Trouble free running of various equipments by taking care in handling the equipment maintaining a regular schedule by changing consumables like oil, grease etc.
2. To have a regular preventive maintenance schedule in order so that minor damages does not lead to major repairs.
3. To reduce the operational cost and repair cost by monitoring the equipment regularly.

It is also essential that trained manpower should be employed and constant up-gradation of their skills by constant interaction and counseling and the operational staff should be thoroughly trained in various activities like fire fighting, first aid and do's and don'ts to avoid accidents. It is also essential to maintain the required tools, safety gears to the staff.

PREVENTIVE MAINTENANCE STAFF

Daily :

1. Check flow levels
2. Oil level of all equipments
3. Check dissolved oxygen in aeration tank
4. An MLSS of 3000 to 5000 mg/l should be maintained in aeration tank for effective biological action.
5. A dissolved oxygen of 2ppm should be maintained in aeration tank for effective biological process.

Weekly : Oiling and greasing of bearings and gears of mechanical equipments.

Monthly : Greasing of bearings, mechanical

equipment, checking of bolts and nuts of equipment. Tightening of all bolts and nuts of all equipments.

Quarterly : Replacement of gear oil and lubricant after every 2000 hours of operation.

1. Receiving Pumps

1. Floating material in the receiving pump to be removed once in two days.
2. Voltmeter, Ammeter, Flow meter readings to be checked frequently.
3. Junction boxes to be checked once in a week.
4. Contactors to be cleaned with CRC Spray.

2. Screen Chamber

1. The screenings to be removed once in 15 minutes.
2. Meshes to be replaced once in 15 days.
3. Greasing to be done for bearing and pinion of mechanical screen weekly once.
4. Gear box oil to be checked - daily.
5. Amps, Volts to be checked frequently.

During normal operation the isolation gate leading to the manual screen is kept closed and the entire sewage is allowed to flow through the mechanical screen.

The frequency of operation of the raking mechanism is to be fine tuned based on the quality of floating material in the sewage. However, care should be taken to avoid excessive screenings to be retained on the screen, as this would result in level build up on the stream of the screen.

Regular preventive maintenance on the moving part of the screen is mandatory for continuous trouble free performance of the screen mechanism.

3. Degritting

1. Ensure that the scraper mechanism is run continuously when the sewage flows through the unit.
2. The agitator should be run continuously for ensuring the washing off organic material from the collected grit. This enables the separation of grit particles devoid of any organic material.
3. The operation of the rake classifier shall be intermittent depending on the grit collected.
4. Regular maintenance on the rake classifier is mandatory for proper functioning of the unit i.e. greasing to be done for all moving parts - weekly once.
5. Gear box oil level checking - daily.
6. Amps, volts of the motor to be checked frequently.

4. Aeration Tank

1. Gear box oil level checking - daily.
2. Bolts & Nuts checking - daily.
3. Gear box oil to be replaced after 2000 hours of operation.
4. Motor Amps, Volts to be checked frequently.
5. Contactors to be cleaned with CRC Spray.
6. Motor drive end, non-drive end bearings greasing to be done quarterly.
7. All panels to be cleaned with blower once in 15 days.

5. Secondary Settling Tank

1. Reduction gear box, main gear box oil level checking - daily.
2. Cleaning & greasing to be done for the chain - weekly.
3. Floating material to be removed - daily.

6. Sludge Pumps

1. Motor bearings greasing to be done - quarterly.
2. Coupling bushes changed - quarterly.
3. Gland ropes changing once the three weeks.
4. Impeller cleaning - daily through inspection chamber.
5. Nuts & Bolts checking - daily.
6. Floating material to be removed - daily from wet well.
7. Motor Amps, volts to be checked - frequently.

Ensure that the valve on the delivery side leading to the aeration tank is always kept open.

Ensure that there is a continuous withdrawal of sludge from the settling tank and the sludge is transferred to the subsequent unit.

7. D'Canter Centrifuge

- Daily :**
1. Grease the bearing after every 8 hours of operation.
 2. Check whether the grease is going to all bearings or not.
 3. Check the belt tightness.

Weekly : Tighten all the bolts and fasteners.

Fortnightly: Grease the needle roller bearing by grease gun.

- Monthly:**
1. Poke the water returning channels by means of rod.
 2. Remove the top casing and cleaning the discharge port.

3. Removing the bearing top housing and replace old grease with new.

After 1000 hours of running

1. Replace the fluid coupling oil.
2. Replace the cycle gear grease.

8. Dosing Pump

- Daily :**
1. Oil level to be checked.
 2. Check for any leakage through the gland.
 3. Nuts & Bolts to be checked.
 4. Check for leakage at pipeline connections with the pump.
 5. Replace oil after 2000 running hours.

9. Filterate Pumps

1. Motor bearing greasing - quarterly
- The operators should develop sensory skills like touch and hearing to find out the variation in vibrations and to fore warn any problems.

STP for 20 MLD at Madarsa Maktha

ELECTRICAL MAINTENANCE

1. Contactors cleaning of pumps, areators motors - weekly.
2. Junction box checking of Receiving pumps Maktha Pumps, Somajiguda Pumps - weekly.

List of Registers

Aerators 16 Nos.	—	16
Receiving pumps	—	4
Somajiguda Pumps	—	3
Madarsa Maktha Pumps	—	2
Degritting / rake classifier	—	1
Mechanical Screen	—	1
De-canter centrifuge	—	1
Filtrate pumps	—	2
Dosing pump	—	1
		31

In each Register there are three columns namely, Date, No. of running Hours, Remarks. In dosing pumps Date, No. of Hours, Polyelectrolyte used in Kgs, sludge output in tones.

Test Reports for 20 MLD STP at Hussainsagar Lake, Hyderabad during in the Year: 1999-2000

Parameters Tested for the Year 1999 - 2000																				
Months	pH		SS (mg/L)		Phosphates as PO ₄ (mg/L)		Phosphates as P (mg/L)		Nitrates as NO ₃ (mg/L)		Total Kjeldahl Nitrogen (mg/L)		Total Nitrogen (mg/L)		COD (mg/L)		BOD ₅ at 27°C (mg/L)		Dissolved Oxygen (mg/L)	
	I.S. at RC	TE. at SST	I.S. at RC	TE. at SST	I.S. at RC	TE. at SST	I.S. at RC	TE. at SST	I.S. at RC	TE. at SST	I.S. at RC	TE. at SST	I.S. at RC	TE. at SST	I.S. at RC	TE. at SST	I.S. at RC	TE. at SST	I.S. at AT	TE. at SST
April, 1999	7.15	7.84	404.53	27.73	14.93	10.80	—	—	41.60	158.13	62.60	9.47	—	—	720.93	52.27	386.00	6.67	2.12	5.16
May, 1999	7.13	7.77	368.45	26.71	14.68	11.61	—	—	29.42	157.23	54.35	8.48	—	—	572.84	47.61	308.06	6.19	2.20	5.41
Jun, 1999	7.15	7.78	361.87	25.93	14.87	12.17	—	—	23.23	156.80	48.20	7.13	60.74	43.79	456.53	45.80	244.00	6.17	2.22	5.55
Jul, 1999	7.10	7.70	377.35	26.74	10.55	7.97	—	—	27.16	156.00	51.58	7.03	57.52	42.29	504.35	48.13	267.26	6.68	2.26	5.20
Aug, 1999	7.09	7.71	400.77	26.68	12.00	9.00	—	—	20.52	156.58	52.81	6.29	57.52	41.74	594.32	50.65	310.97	6.90	2.33	5.04
Sep, 1999	7.05	7.65	397.13	26.20	13.90	10.47	3.43	2.33	16.20	142.13	49.80	6.23	53.63	38.43	569.77	45.87	297.17	6.27	2.40	4.31
Oct, 1999	7.09	7.63	498.97	24.77	13.23	6.71	4.32	2.19	7.45	67.84	37.97	7.19	39.68	22.52	565.29	45.16	280.81	5.87	2.35	3.25
Nov, 1999	7.12	7.73	489.53	26.20	17.70	6.97	5.77	2.27	7.23	55.73	38.23	6.37	39.87	19.17	580.20	47.20	281.83	6.93	2.22	2.85
Dec, 1999	7.08	7.71	534.06	26.52	20.55	8.19	6.7	2.67	7.45	54.77	39.97	5.58	41.61	18.06	707.1	45.42	335.65	6.84	2.13	3.22
Jan, 2000	7.09	7.67	460.58	25.81	18.35	7.39	5.99	2.41	9.81	69.84	39.39	5.00	41.35	20.90	683.94	41.68	328.87	6.35	2.15	3.60
Feb, 2000	7.05	7.61	508.07	27.28	21.21	7.45	6.77	2.43	10.72	71.24	40.79	7.10	43.34	23.17	807.10	50.69	378.45	8.28	2.12	3.26
Mar, 2000	6.99	7.57	536.52	27.32	23.16	6.90	7.56	2.25	10.65	68.97	41.90	7.00	44.32	22.61	907.68	52.52	415.48	8.39	2.12	3.29
Average	7.09	7.70	444.82	26.49	16.26	8.80	5.78	2.36	17.62	109.61	46.47	6.91	47.96	29.27	639.17	47.75	319.55	6.80	2.22	4.18

List of Abbreviations

IS = Influent Sample
TE = Treated Effluent

RC = Receiving Chamber
SST = Sludge Settling Tank

AT = Aeration Tank
COD = Chemical Oxygen Demand

BOD = Biochemical Oxygen Demand

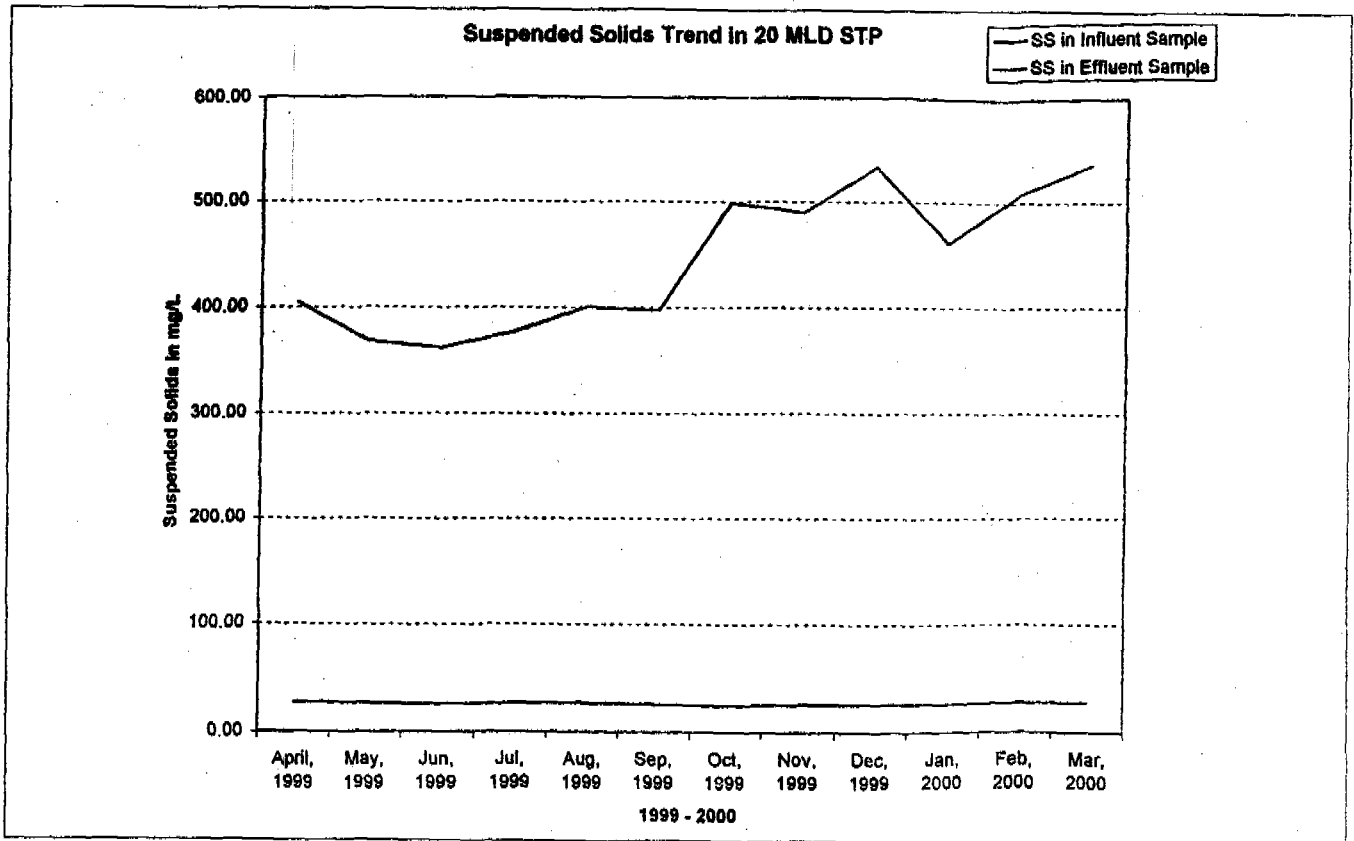
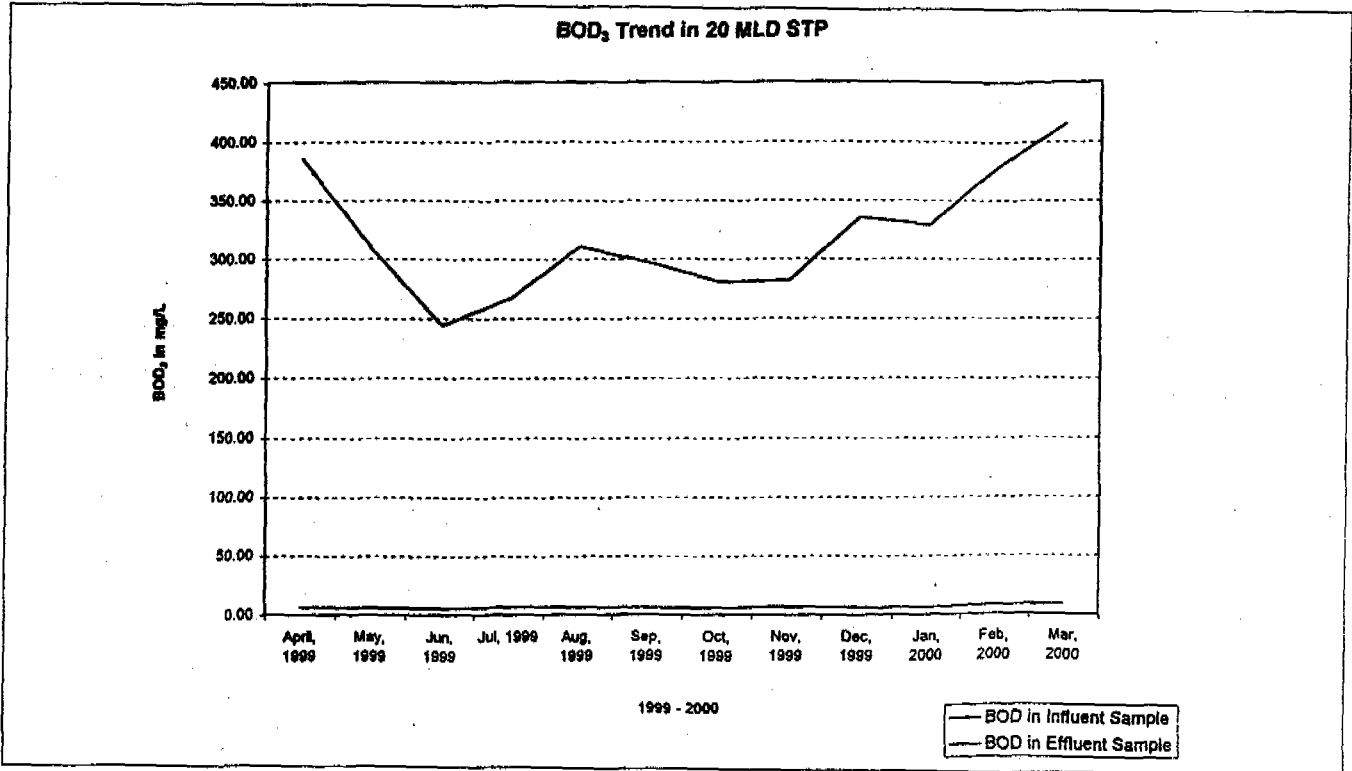

Performance Evaluation of the STP

Objective

Main objective of Hussainsagar Lake is to treat the residential sewage received from duplicate 'A' main and Balkapur Channel and, in turn, the treated effluent with improved standards is to be let out into Hussainsagar Lake to improve and maintain the hydrology in Lake Environment. This treatment plant is designed for 20 MLD sewage treatment and to minimize the Biological Oxygen Demand and Suspended Solids within the Standards. The following parameters are observed to know their trend during one year.

- (i) pH
- (ii) Suspended Solids
- (iii) Phosphates as 'PO₄'
- (iv) Phosphates as 'P'
- (v) Nitrates as 'NO₃'
- (vi) Total Kjeldahl Nitrogen
- (vii) Total Nitrogen
- (viii) COD (Chemical Oxygen Demand)
- (ix) Three Biological Oxygen Demand (BOD₃) at 27°C and
- (x) Dissolved Oxygen.

The brief explanation about these parameters trend is discussed in subsequent sections below.

• Characteristics of the wastewater and Test Results after the extended aeration treatment process.

To impart environmental conditions and maintain hydrology in Hussainsagar Lake, HMWSSB has commissioned one 20 MLD Sewage Treatment Plant by adopting the extended aeration process. Ten parameters specified above are monitored during the treatment process at Hussainsagar Lake. As a case study on the performance of the treatment plant, one year record is observed on residential wastewater characteristics received from Duplicate 'A' Main sewer and Balkapur Channel. The study on these parameters recorded throughout the year provides some ideology for understanding the treatment process and its trend during seasonal changes. The results are also plotted on the graphs to see the variation in one-year period. Each parameter is discussed below :

(i) pH Trend :

It is found that pH in influent at Receiving Chamber

(RC) is almost around 7.00. Average pH of the influent is 7.09 during one-year span. The residential sewage characteristic is obviously seen neutral in nature that provides a good environment for bacterial growth. Wastewater with an adverse concentration of hydrogen-ion is difficult to treat by biological means. Hence this environment is very closely helpful for extended aeration treatment. Most bacteria cannot survive pH levels above 9.5 or below 4.0. Optimum pH for bacterial growth ranges from 6.5 to 7.5. After treatment, the effluent pH is observed 7.70 on average that edges the slight difference of 0.20. The pH trend almost remains constant throughout the year with a maximum of 7.84. Therefore, pH of surface water body is not much affected after let out the effluent into the lake.

(ii) Suspended Solids Trend :

In the aquatic environment Suspended Solids (SS) can lead anaerobic conditions when untreated wastewater is discharged. As far as Suspended Solids Removal is concerned, the influent is having average value of 444.82 mg/L with minimum and maximum of 368.45 in May, 1999 and 536.52 mg/L in March, 2000 respectively. The suspended solids in effluent is recorded an average value of 26.49 mg/L, but it ranges from 24.77 to 27.73 mg/L in one year span. Overall percentage removal of Suspended Solids is 94.05 showing outstanding performance.

(iii) Phosphate Trend:

It is most common that Phosphate is available in two forms i.e., Phosphates as PO₄ and Phosphates as 'soluble phosphate (P)' in the wastewater. This is one of the most important nutrients to grow the algae in the surface water. To prevent blue green algal growth in the lakes or avoid eutrophication, it has to be controlled over the Phosphates in the wastewater and be seen that this nutrient level should be less than 10 mg/L. The total concentration of Phosphates is average value of 30.67 mg/L and 11.16 mg/L in influent and effluent respectively. After treatment, Phosphates concentration is found above the limiting value of 10.0 mg/L that aggravates the algae growth in the Lake. Hence, Release of Phosphorus occurs under anoxic conditions. Thus, biological phosphorus removal requires both anaerobic and aerobic reactors or zones within a reactor. Suitable additional units in such a way that anaerobic followed by aerobic conditions are to be incorporated in the line of treatment process adopted at the STP.

Diversion arrangements for nalas

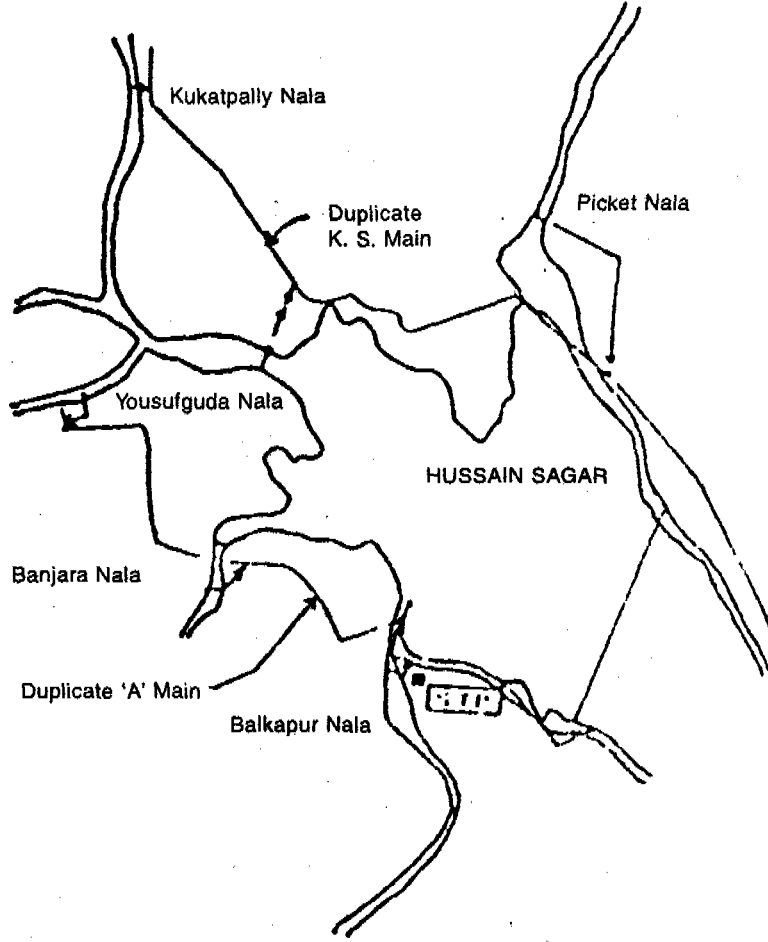

Typical diversion arrangement

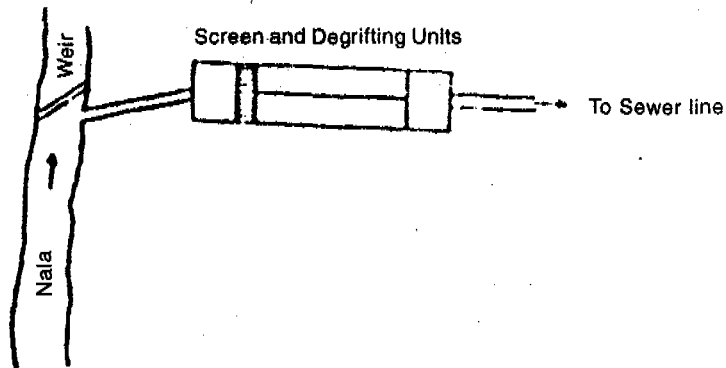

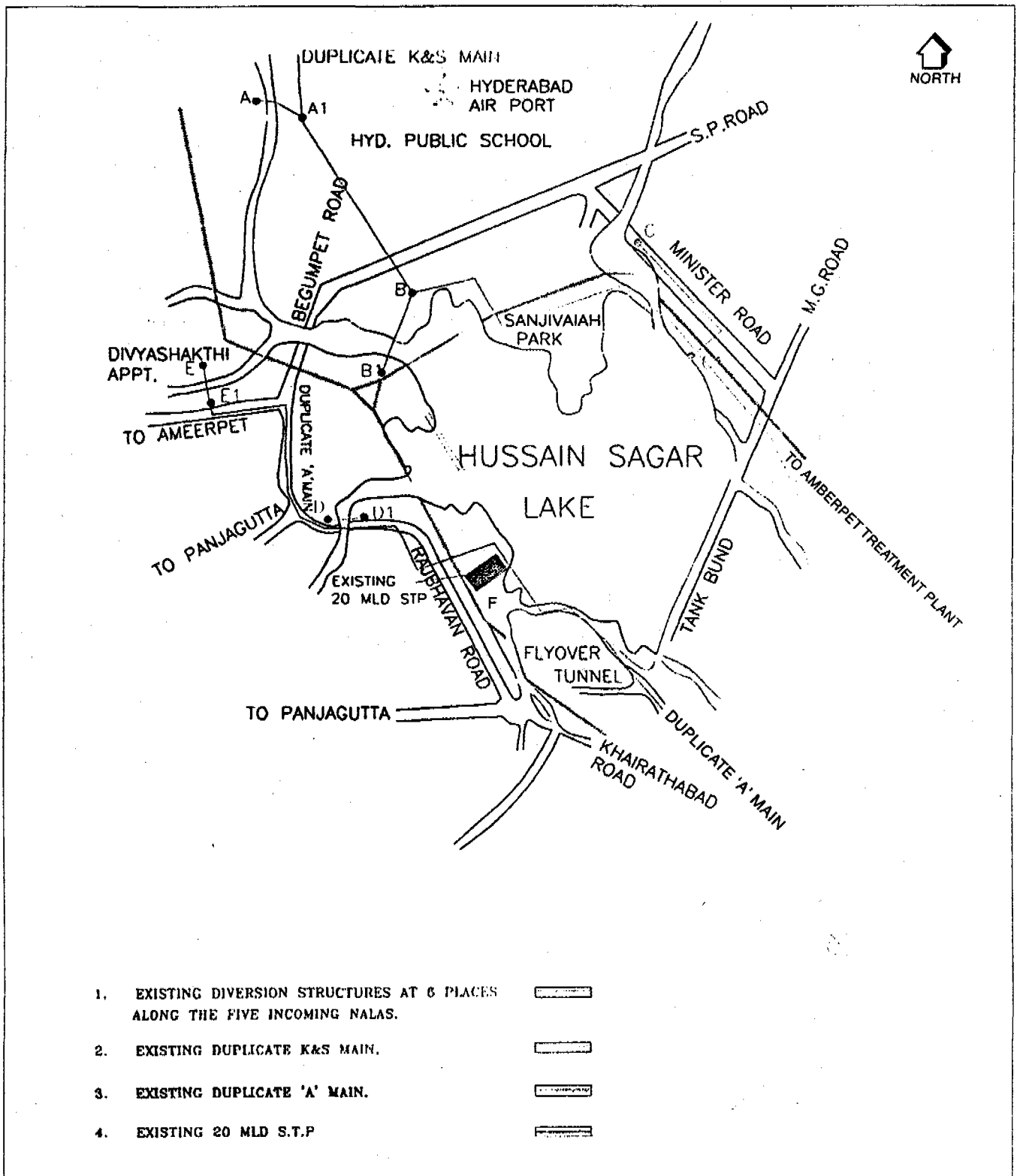

(iv) Nitrogen Trend :

Nitrogen is one of other important nutrient in eutrophication process. In wastewater, total nitrogen is comprised of organic nitrogen, ammonia, nitrite and nitrate. Total Kjeldahl nitrogen is the total of the organic and ammonia nitrogen. Further, nitrate nitrogen is the most highly oxidized form of nitrogen found in wastewater. The test results at STP are listed for nitrogen availability in the entire treatment process. The average value in influent for Nitrates (NO_3), Total Kjeldahl nitrogen and total nitrogen are 17.62 mg/L, 46.47 mg/L, and 47.96 mg/L, respectively in one year span, but the average value for Nitrates after treatment is risen to 109.61 mg/L in effluent where as these values in case of Kjeldahl nitrogen and total nitrogen are controlled to 6.91 mg/L and 29.27 mg/L respectively. Nitrates may normally range from 0 to 20 mg/L as 'N' in wastewater effluents. It is observed that a typical range is from 15 to 20 mg/L as 'N'. In this treatment, Nitrogen concentration is shot up beyond the limits because most available aerobic conditions are given by extended aeration process. As this is to control with in the standards stated above, the anaerobic conditions are to be provided to remove Nitrogen biologically. Otherwise, this nutrient, apart from Phosphates exaggerates the algal growth process resulting into abnormal eutrophication in the Lake.

(v) COD Trend :

It is noticed from the test results that COD concentration is recorded 907.68 mg/L as maximum in March 2000 and 456.53 mg/L as minimum in Jun 2000 in the influent at the receiving chamber. Average concentration is of 639.17 mg/L whereas it is 47.75 mg/L in the effluent. Over all percentage removal in COD is 92.53 through this aerobic process.

(vi) Three Day Biochemical Oxygen Demand Trend:

Average BOD₃ is recorded 319.55 mg/L in influent and that of 6.80 mg/L in effluent. The removal percentage in extended aeration process is arrived 97.87 showing that bacterial growth rate in the treatment is exceptionally good. MLSS environmental

conditions are prevailing in the aeration tank during wastewater detention that promotes the biological reaction process for nitrates formation. It is also seen that the nitrates concentration in effluent is risen. Hence, proper recycle operation is further monitored in aeration tank to balance the MLSS environment.

(vii) Dissolved Oxygen Trend :

Average Dissolved Oxygen (DO) in influent is recorded 2.22 mg/L and that of 4.18 mg/L in effluent in the treatment process. Increase in DO is of 1.96 mg/L after the treatment. Effluent DO is only 4.18 mg/L lower than minimum requirement 6.0 mg/L for better living of aquatic life in the lakes or streams. As dissolved oxygen is an important characteristic in water, it is opined that MLSS in aeration tank is to be monitored by fixing the recycle ratio apart from the implementation of nutrients removals by incorporating the anaerobic and aerobic conditions simultaneously in the treatment process. Further, as temperature is also one predominant parameter in entire process, various test results are compared with respect to the temperature. In case of dissolved oxygen, it may reach the lower level under temperature influence during summer season.

The test results are all tabulated and various graphs for these parameters are drawn and appended below.

CONCLUSION

It is felt that the extended aeration process holds good for removal of BOD₃ at 27°C and Suspended Solids. At the same time, it is contributed more values in regard of nitrates as 'N'. The parameters like pH, Suspended Solids, BOD and COD, Performance of the plant is given about 95.00% removal under ideal conditions. However, the removal of excess 'N' & 'P', an improvised phosphorus and nitrogen removal process units are to be incorporated in the existing treatment process. Thereby, it can be achieved proper removal of N & P concentrations. Further, we are in stage of generating data with respect to temperature parameter and it will also be premature to arrive at the conclusion for adding any necessary process units for anoxic as well as anaerobic conditions in the process of the existing treatment.

Technology Innovation in Waste Water Treatment

S Vaidyanathan

Chief Engineer, Design & Consultancy CME P O, Pune

Abstract

In biological treatment of Waste Water characterised by Activated Sludge Process, Aeration of Waste Water is necessary for degradation of organic matter. In Waste Water treatment plants, aeration is accomplished by means of aerating devices or Aerators. This paper deals with the new technology in Aeration, employment of Dry Motor Submersible Pump with injectors to both thoroughly mix and diffuse oxygen in Waste Water/Sewage. The various aspects which needs consideration in the aeration process, optimisation are briefly described. The advantages of the new submerged aerator is highlighted. The efficiency of this aerator is highlighted. The efficiency of this aerator in terms of removal of BOD and suspended solids, is also studied.

Introduction

The availability of a reliable and cost effective Aerator is mandatory for effective and efficient aerobic treatment of charged Waste. Oxygen transfer capabilities of different types of Aeration devices are to be evaluated and typical information in this regard should be available for ready application for arriving at the oxygenation capacity of the Aerator. The advantages/disadvantages of different types of Aerators are to be made available so that the Environment Engineer can choose and design the Aerator depending upon the type of waste to be treated. With this background, it is necessary to explore alternatives for augmenting Aeration technology. These alternatives, should be reliable, cost effective, technically viable and based on proven technology.

GAS TRANSFER

Gas transfer is vital part of a Waste Water treatment Process. For example the functioning of aerobic processes such as activated biological filters and aerobic digestion depends on the availability of sufficient quantities of oxygen.

Theory

Out of the numerous Theories of mass transfer that are used to explain the mechanism of gas transfer, one of the most commonly used is the two film theory. The theory is based on physical model in which two films exist at the gas liquid interface. The two films one liquid and one gas provide the resistance to the passage of gas molecules between the bulk-liquid and bulk-gaseous phases. For transfer of gas molecules from the gas phase to the liquid phase, slightly soluble gases encounter the primary resistance from the liquid film, while very soluble gases encounter the primary resistance from the gaseous film. Gases of intermediate solubility encounter significant resistance from both films. A sketch of these films is given in Figure - 1.

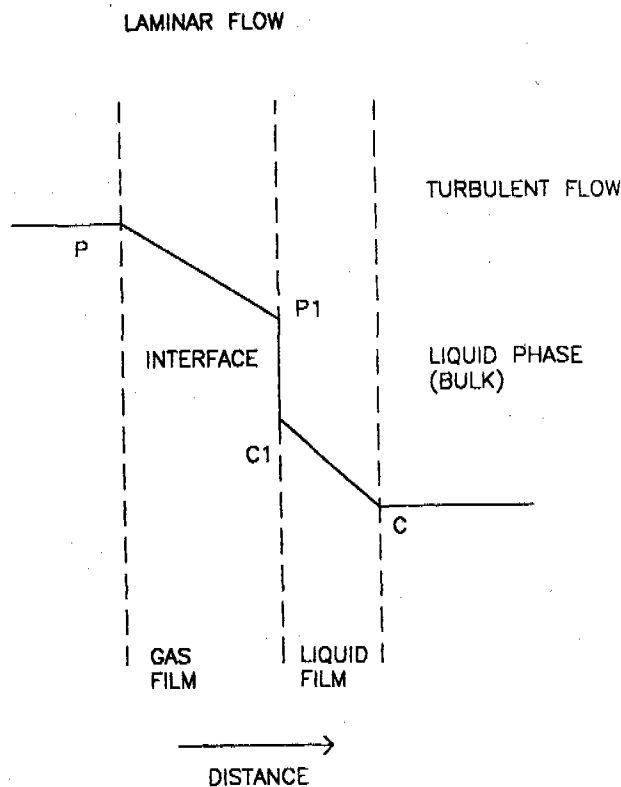

Fig. 1. Partial Pressure and Concentration

The gas transfer in general, is proportional to the difference between the existing concentration and the equilibrium concentration of the gas in solution. In equation form, this relationship can be expressed as,

$$dc/dt = K(C_s - C) \dots\dots\dots (1)$$

Where

C = gas concentration

t = time

C_s = Saturation concentration of gas

K = Proportionality constant 'K' includes the effect of resistance of either or both films, and is also function of the area of liquid-gas interface that exists per unit volume of fluid. The equilibrium concentration of gas dissolved in a liquid is a function of the partial pressure of the gas adjacent to the liquid.

In addition to the partial pressure, the amount of gas that can be taken up by a liquid depends on any subsequent reactions that the gas may undergo after it is dissolved. Chlorine, for example reacts with water to form HOCl and HCl and for this reason large quantities of chlorine can be taken up by water. Oxygen molecules, on the other hand, apparently do not react with water molecules and thus comparatively, little oxygen can be taken up by water. Sufficient oxygen to meet the requirements of aerobic waste treatment do not enter water through air - water inter-faces. This is because of the low solubility of oxygen and consequently low rate of oxygen transfer. To transfer large quantities of oxygen into water, that are needed, additional interfaces must be formed. Oxygen can be supplied by means of bubbles introduced to the water to create additional air water interfaces. In waste water treatment plants aeration is most frequently accomplished by dispersing air bubbles in the liquid at depths upto 4 M by means of aerating devices such as :-

- (1) Porous plates and tubes
- (2) Perforated pipes
- (3) Through turbines
- (4) Hydraulic shear devices

Aeration is also achieved through mechanical Aerators consisting of high speed turbines operating at the surface of the liquid partially submerged. They are also designed so as to intimately mix and circulate large volumes of air and water.

Efficient gas transfer also depends on agitation of the water. The agitation reduces the thickness of the liquid film and lowers resistance to transfer and to dispersion of the dissolved gas once transfer has taken place. Air bubbles have a lifting effect due to viscous drag, and they promote agitation and circulation of the liquid. Introduction of air at the bottom of the tank promotes spiral flow of the liquid mass. The flow carries the smaller bubbles across the surface increasing the period of contact (t) and also continually exposing fresh liquid to absorption of atmospheric air. This action keeps the mixed liquor solids in suspension with a minimum use of air for agitation and provides oxygen transfer required by the process.

For a given volume of water being aerated, aerators are evaluated on the basis of the quantity of

oxygen transferred per unit of air introduced to the water for equivalent conditions (Temperature, chemical composition of water, depth at which the air is introduced).

The oxygen is used by micro organisms as rapidly as it is supplied. The equation (1) can be written as

$$dc/dt = K (C_s - C) - U_m \dots\dots\dots(2)$$

Where U_m is the quantity of oxygen used by the micro organisms. If the oxygen level is maintained at constant level $dc/dt = 0$ and

$$U_m = K(C_s - C) \dots\dots\dots (3)$$

$$K = U_m / (C_s - C) \dots\dots\dots (4)$$

The transfer coefficient are usually made on water and then corrected for the waste water. For relatively fresh sewage, value of 26 to 46% of the fresh water transfer coefficient were observed under Indian conditions.

SUBMERSIBLE AERATOR

Design

The Aerator developed by KISHOR PUMPS, employs a Dry Motor Submersible Pump driven by an air-filled electric motor, cooled by surrounding liquid. The impellar is directly mounted onto the shaft of the motor and there is no coupling in between. At the shaft, two mechanical seals are provided for effective sealing of the motor from the liquid. Both the seals run on oil. The seal immediately behind the impeller is provided with silicon carbide face for extended life. For motor protection, sensors are provided in winding which trip the circuit on reaching a preset temperature. The pumps are also provided with sensing device to signal against ingress of water into the oil chamber. Further patented reverse rotation device is also incorporated into the system. Ventury injectors are directly attached to the discharge branch. Air pipe which jets out of the waste water level in the Aeration Tank is connected to the injector. One, two, three or four nozzles can be accommodated in the ventury injector.

Working Principle

The ventury injectors draw air from the atmosphere through the air pipe connected to them. The pump forces the sewage or waste water through ventury injector. Impinging a flow of sewage or waste water at the nozzle breaks the air bubbles into smaller size. For a given amount of air introduced to a sewage or waste water, the available surface through which the gas transfer can take place, increases with decreasing bubble size. That is 'K' in equation (4) increases as the

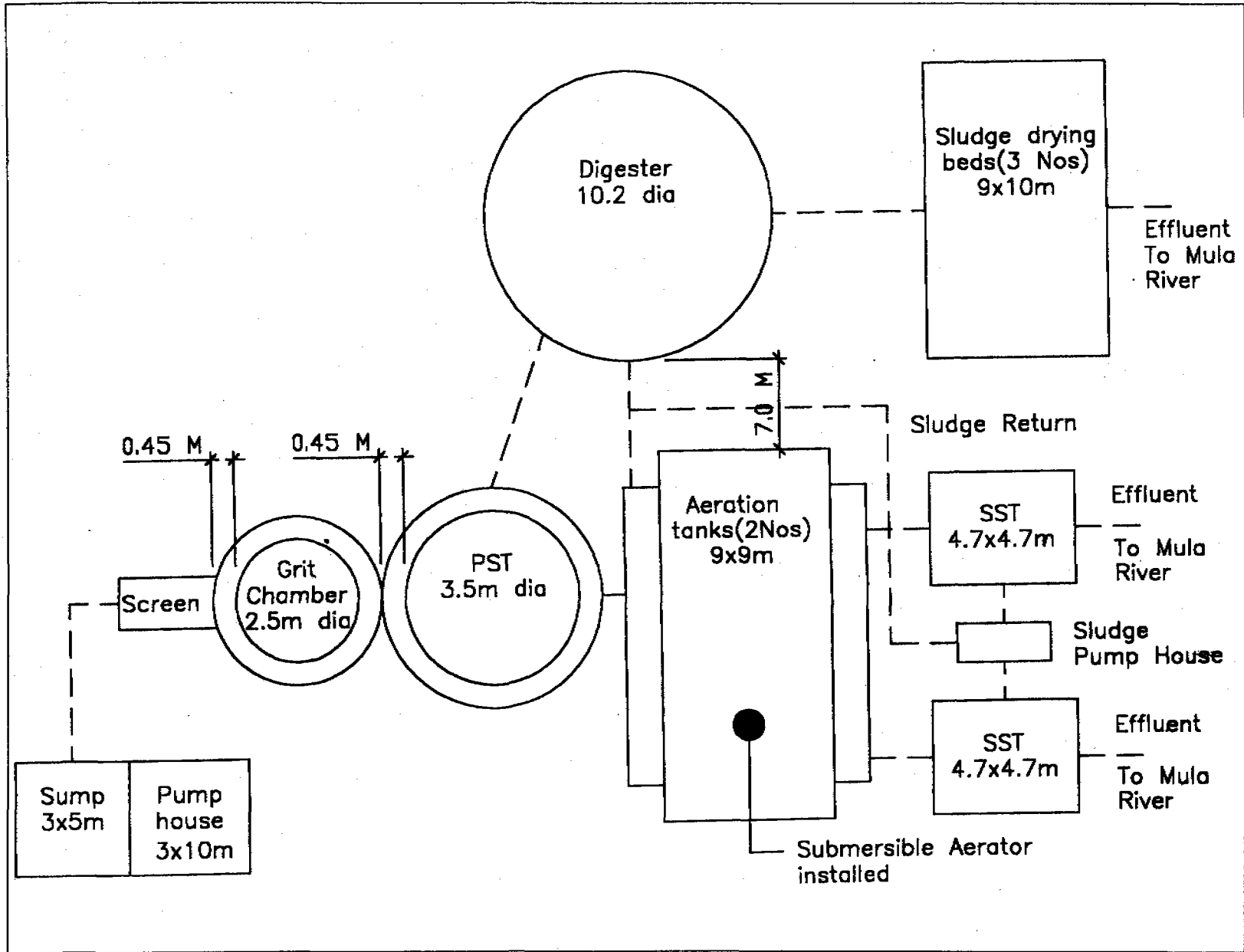

Fig. 2. Layout of Existing Plant.

bubble size decreases, because surface area to volume ratio changes. Small size air bubbles lift up due to viscous drag and this promotes turbulence. The spiral flow path is formed by the bubble. Spiral flow carries the smaller bubbles across the surface and thus increases the period of contact and continually exposes fresh waste water to the atmospheric air. This action also keeps the mixed liquor suspended solids (MLSS) in the Aeration Tank in suspension. It is observed that the air bubbles are ejected with a high velocity in the horizontal direction first and then allowed to rise up. Therefore bubbles travel long distances and therefore contact time (t) increases, Every attempt has been made in this aerator to increase contact time, turbulence so that oxygen absorption is more. Oxygenation capacity of the submersible aerator gets enhanced in view of the above facts.

Study on Oxygen Transfer

It was proposed to study the performance of the KDS Aerator by installing the same in the Sewage Treatment Plant constructed in the campus of College of Military Engineering, Pune. The sewage Treatment Plant is provided for the treatment of the waste water from the college campus. The effluent from the plant is discharged into Mula river.

The plant is a conventional type, the biological treatment is characterised by the conventional activated sludge process with the provision of primary settling tank (PST), aeration unit, a Secondary Settling Tank (SST), sludge digester to handle primary and Secondary Sludge and Sludge Drying Beds (SDB) for sundrying of the digested sludge. A raw sewage sump with two submersible pumps is also provided. A grit chamber alongwith bar screens is also provided. The layout of the plant is given in Figure 2.

The plant is not in working condition. The suspended solids settling in PST are not being removed to digester since the sludge pumps are not working. The organic solids are eventually carried into the aeration tank and the Aeration Tank is filled with the organic solids. The KDS submersible aerator was installed in one of the two Aerator Tanks with the help of a crane. The aerator has two nozzle and each nozzle is 5HP capacity. The aerator is free standing on the floor and is placed in the centre of the Aeration Tank (size 9M x 9M). The Air Pipe is 80mm dia and was projecting beyond the waste water level in the Aeration Tank.

A velocity of air drawn by the nozzle through the air pipe is measured with the help of a standard velocity meter. The standard velocity meter exactly fits into the air pipe. The diameter of the air pipe is 80mm and the

diameter of the velocity meter fan blades are of 80mm diameter.

The velocity of air entering the air pipe was measured holding the same on the top of the air pipe, standing on the approach bridge in the Aerating Tank. The velocity of air was measured during different times of the day of velocity of the air measured during the day and on different days. The average velocity of the air is 3.2 m/s. The details of the velocity of the air measured during the different days are given below :-

Date	Velocity of air (m/Sec)
07.1.95	2.8
11.1.95	2.8
21.1.95	3.1
23.1.95	3.1
24.1.95	2.8
25.1.95	3.2
03.2.95	3.2
07.2.95	3.1
12.2.95	3.1
18.2.95	3.1
04.3.95	3.1
12.3.95	2.9
05.4.95	3.0
16.4.95	3.1
22.4.95	3.2
23.4.95	3.1
01.5.95	3.1
02.5.95	3.0
02.5.95	3.2

- (1) The velocity of : 3.2m/sec
air drawn
- (2) Area of cross : (3.14x0.08x0.08)/4
section of the air pipe =0.005 sm
- (3) Volume of air drawn : 0.005x3.2x3600=
57.6 CM/hr
- (4) Assuming the average 57.6x1.4=80.64kg/hr
density of atmosphere air
as 1.4 kg/CM quantity of
air drawn
- (5) Assuming that 23.4% 80.64x0.234 =
of oxygen is available 19.97 kg hr
in air (depends on the
temperature) The amount
of oxygen supplied to sewage
- (6) Since the aeration 18.97x2=37.94Kg/hr
was provided with 2 nozzles,
Total oxygen supplied

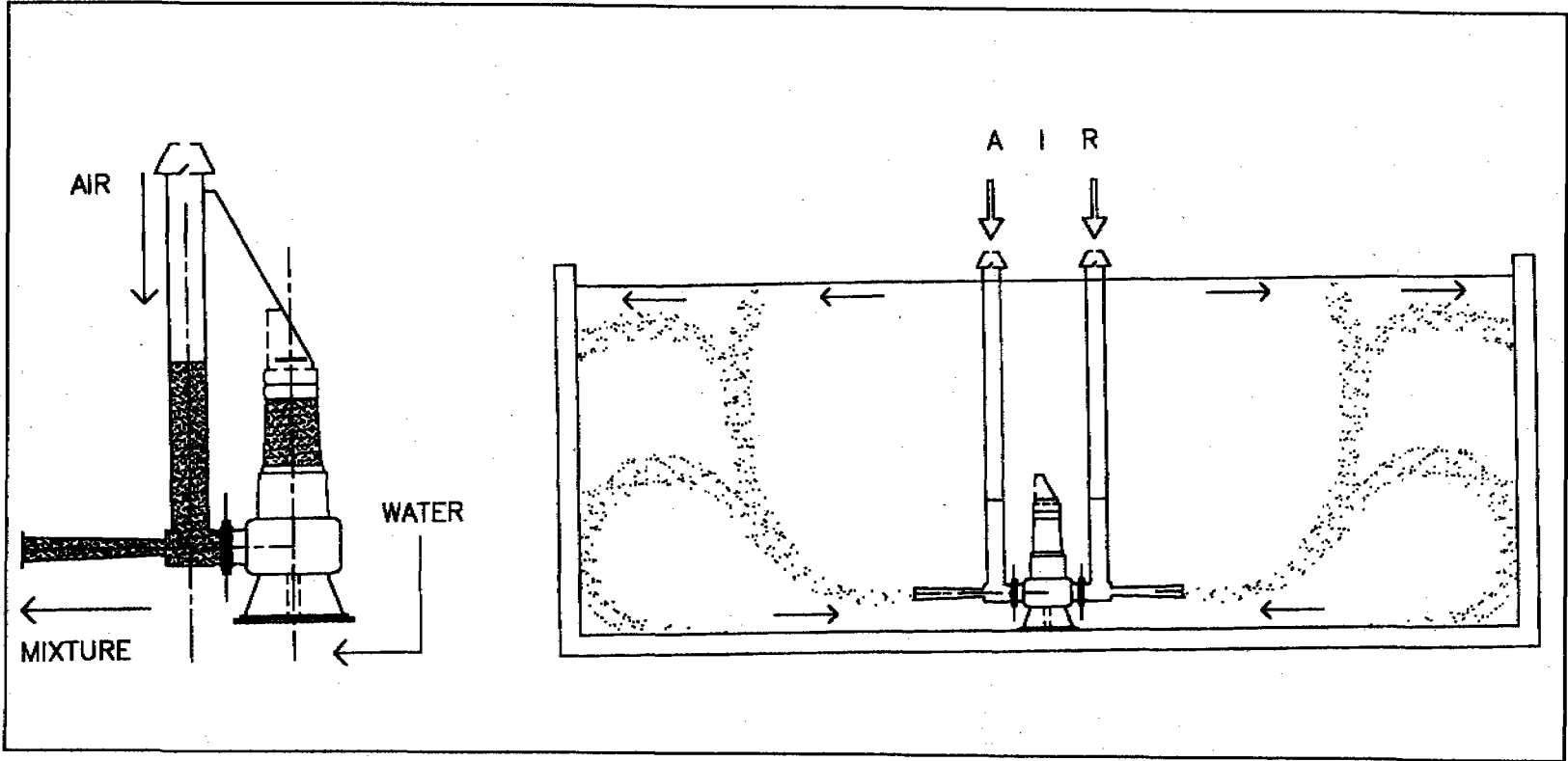

Fig. 3. Submersible Aerator

For given volume of water being aerated, aerators are evaluated on the basis of the quantity of oxygen transferred per unit of air introduced to the water for equivalent conditions, temperature composition of water, the depth at which the air is introduced. For this purpose, 5 day BOD at 20 C of the influent to the Aeration Tank and effluent from the same was measured in the laboratory. The BOD was measured by taking samples during different times in a day and during different days, after installation of the Submersible Aerator. The details are given below :-

Date of Collection	5 day BOD at 20 C		Remarks
	Influent mg/lit	Effluent mg/lit	
21.1.95	200	54	
21.1.95	204	48	
23.1.95	130	40	
24.1.95	200	85	
25.1.95	210	50	
03.2.95	85	30	Not considered Unrealistic
07.2.95	210	32	
12.2.95	210	50	Not considered
04.3.95	130	22	Unrealistic

The BOD was measured by the procedure outlined in para 53 of IS 3025-1964. The dilutions are adopted keeping in mind the amount of Influent BOD and expected BOD of the effluent from Aeration Tank. Erratic values of the BOD were discarded.

- | | |
|--|-------------|
| (1) Peak flow: | 3 mld |
| Average flow : | 1.45 mld |
| (2) 5 day BOD of the Influent | 202.0mg/l |
| (3) 5 day BOD of the Effluent | 54.0 mg/l |
| 5 day BOD removed in the Aeration Tank | 148.00 mg/l |

Oxygen actually transferred to the waste water is $148.6 \times 3 \times 10$ mg/day

$$\frac{148.6 \times 3 \times 1000 \times 1000}{1000 \times 1000 \times 24} = 18.6 \text{ kg/hr}$$

This is approximately 50% of the oxygen available in the air drawn by the Aerator.

ADVANTAGES OF SUBMERSIBLE AERATOR

Kishor KDA Aerators are free standing on the floor and do not require investment in civil engineering works such as bridges and foundations. The Aerators could

be relocated at will and are not confined to a place. In the existing sewage treatment plant, initially we placed the Aerator adjoining the side wall of the Aerator tank and subsequently we shifted the same and placed in the centre of the Aeration Tank, with the help of a 3 tonnes crane, we were able to shift and place the Aerator in the centre of the Aeration Tank and a flexible electric connection from the main electric panel given with the electric cable.

For selection of the Aerator capacity, it is necessary to ascertain the zone of influence of each nozzle of the Aerator. The zone of influence of the 5HP Aerator with a nozzle in opposite directions is observed to be 9M x 9M, the aerator being placed at the centre of the tank.

In the case of surface Aerators the oxygen transfer varies with submergence of the impellers of the Aerator and there exists a optimum submergence at which the oxygenation efficiency is maximum. This optimum submergence has to be changed to take care of average and peak flows. This flexibility in the system is very difficult to achieve and there is a danger of total collapse by exposure of the blades. In the case of submersible aerators the performance does not vary appreciably with water level.

The maintenance is simple and easy to operate because the drive is direct and there are no reduction gears or line shafts which need constant attention, lubrication and maintenance. All equipment and controls are at ground level outside the aeration tank.

The Submersible Aerator was installed in the Aeration Tank on 01 Jan 95 and was working continuously all 24 hours and finally removed on 30.9.95. The Aerator was working on 'Auto Stop'. It was not working when the power was not available and it got automatically switched on when the power was available. It is very robust and reliable in operation and was working during variations in flow, both average and peak.



During operation it was observed that settlement of organic solids in the Aeration tank is totally absent due to thorough mixing and agitation. The Aerator was constantly pushing the aerated organic solids in the effluent channel of the Aeration tank. It was also observed that the sludge produced as result of settlement of Aerated solids appear to be more stable and less offensive and odour reduction has been dramatic. This obviously leads to the inference that sludge can be directly dried on the sludge drying beds without digestion.

CONCLUSION

KDA Aerators developed from Dry motor submersible pumps is a new advance concept of aeration which has several advantages over the conventional surface aerators. KDA Aerators do not require investment in civil engineering works such as bridges and foundations. These aerators could be relocated at will. The oxygenation capacity of this submerged aerator is required to be evaluated for application in sugar industry, paper and pulp, and Distilleries. Further studies are required to be done.

Economical Treatment of Sewage by Soil Scape Process

Sandeep Joshi

Technical Director, Shrishti Eco-Research Institute,
S. N. 36/1/1, M. N. 199, Vadgaon Khurd,
Sinhagad Road, Pune-411041

Sayali Joshi

Microbiologist, Shrishti Eco-Research Institute,
S. N. 36/1/1, M. N. 199, Vadgaon Khurd,
Sinhagad Road, Pune-411041

Abstract

Soil Scape process is found effective and economical in the treatment of sewage. In the lab scale and field scale applications it is noted that it has consistently removed pollution parameters like COD, BOD, TSS, nitrates, phosphates in the range of 90-99%. Simultaneously the microbial reduction was noted upto 99.9%. TDS and chloride removal was also observed in the range of 20-40%. These observations were noted in a period of 2 years continuously, these reductions occur in a single filtration unit of Soil Scape Process, without any prior treatment of neutralization or settling of solids. It has been noted that this system can accept loading of sewage 1-5 m³ per day per sq. m. surface area of filtration bed. In comparison with other biological systems, this has been found economical as the capital investment is just 30-50% and recurring expenses 10-20% with area requirement just 50% as compared to that of conventional aerobic or anaerobic treatment techniques. This technique can be applied to treat voluminous sewage from the cities and towns.

Introduction

With the increasing population and urbanization, the problem of sewage disposal is increasing astronomically^{1,2}. It is estimated that about 40,000 crores will be required to treat sewage before it enters into the rivers, streams, lakes or seawater.

The outbreaks of epidemics at Delhi, Mumbai, Karad, Surat^{3,4} which claimed hundreds of victims were due to improper disposal of sewage. It has been observed that in many cities, sewerage system is incomplete. In the holy cities like Nashik untreated sewage is released into the river where millions of people bathe in Kumbhamela like gathering.

It has been estimated that a city like Pune would require at least 350 crores to take away sewage from the city to centralized treatment facility. Depending on the technology adapted, the treatment cost may vary from Rs. 240 crores to Rs. 500 crores.

Failures of the mechanical equipments at the treatment facilities may add to the operational costs inclusive of chemicals, electricity and man-power. At the same time conventional systems are found to be vary sensitive to variations at hydraulic as well as pollutants loading. These numerous problems triggered to adapt simple, cost effective and result-oriented ecological treatment system-Soil Scape Process Filter.

Soil Scape Process^{5,6} is the application of ecological principles to remove pollutants from liquid wastes and bioconvert bioprocess for the bioutilization and ecoassimilation into natural cycles again.

The Soil Scape Process filters are being used from last five years to treat the sewage at the field scale. The field scale plant was established after getting the satisfactory results from the lab-scale and pilot-scale treatment plants.

Methodology

Every alternate day untreated and treated sewage samples were collected from the Soil Scape treatment systems, from about 2 years. The samples were analyzed routinely for pH, TSS, TDS, COD, BOD and occasionally for Faecal coliforms, using standard methods⁷. The data was processed statistically. The Soil Scape filter is, schematically shown in fig. 1.

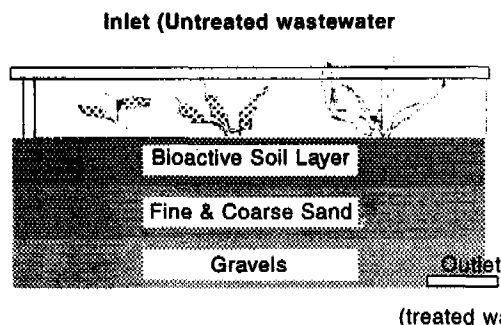

Results and observations

Though there were variation in the pH of untreated sewage from 7.5-8.8 during the study period, the pH range of treated water was 7.3-7.8. There was also significant reduction in turbidity

(98%) measured by nephelometer. The observations are given in table no. 1

Application rate: 1 - 10 m³/m²/day

Average of 120 samples: Sewage flow rate- 100 m³/day

Table 1— Analysis of untreated and filtered water

Sr. No.	Parameter	Concentration in		Removal efficiency%
		Untreated Waste water	Treated Waste water (i.e. after Soil Scape filter)	
1.	TSS mg/L	288.0	22	92.36%
2.	COD mg/L	442.0	48	89.14%
3.	BOD mg/L	234.0	16	93.32%
4.	Nitrates mg/L	35.6		97.19%
5.	Phosphates mg/L	06.4	0.12	98.13%
6.	TDS mg/L	1833.0	1054	42.50%
7.	Chlorides mg/L	485.18	48.75	42.77%
8.	MPN cells/100 ml.	1600	120	92.05%

The removal efficiency of Soil Scape Filter is shown in fig.2

Efficiency of Soil Scape Process Filter

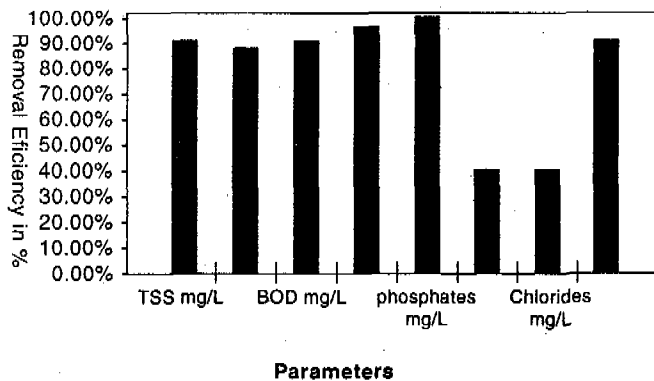

Discussion

From the observation of table 1 and fig. 2, it is stated that the Soil Scape Filter is efficient in removal of suspended solids, COD, BOD, nitrates and phosphates simultaneously. This efficiency can be compared with conventional treatment processes like Activated Sludge Process and Anaerobic Digesters. The comparison is given in the table no. 2

It can be stated that the removal efficiency of Soil Scape Filter is comparatively better as compared to that of other technologies. These conventional techniques may require primary treatment to remove excess of TSS (which may give rise to COD and BOD) prior to secondary treatment¹⁰. This might be due to the better attachment of microbes to the substratum and contact with the pollutants than the suspended growth reactors.

Table 2—Comparison of treatment (%) by various technologies

Sr. No.	Parameters	Soil Scape Filter	Activated sludge Process ^a	Anaerobic Digester ^a
1.	TSS	80-90	65-95	65-95
2.	COD	70-95	60-90	60-95
3.	BOD	70-98	65-95	65-95
4.	Nitrates	60-95	15-50	15-50
5.	Phosphates	60-95	—	40-65
6.	TDS	25-45	—	—
7.	Chlorides	25-45	—	—
8.	Bacteria	90-99.9	80-95	80-95

The treatment train in conventional biological treatment is comprised of equalization, neutralization, primary settling as primary treatment. But in case of Soil Scape Filter, the waste water from septic tanks (i.e. overflow) can be applied directly without having any pretreatment. The Soil Scape Process does not require any cumbersome machinery like stirrers, mixers, clarifier mechanisms and mechanical aerators which are very essential in conventional technologies. The cost comparisons are given in following table no. 3 (the facts are based on actual installations by Shrishti Eco-Research Institute).

Table 3—Comparison of Soil Scape Filter and other technologies (considering the 100 m³/day flowrate)

Item	Soil Scape Filter	Activated Sludge Process	Anaerobic Systems
Capital expenditure inclusive of construction and machineries for primary and secondary treatment units	Rs. 5/- per litre	Rs. 13/- per litre	Rs. 12/- per litre
Energy Requirement H.P.	0.05 per m ³ day	0.5 per m ³ day	0.5 per m ³ day
Operating Cost	Rs. 500/- per m ³ per year	Rs. 3000/- per m ³ per year	Rs. 3400/- per m ³ per year
Area requirement (including ancillary units) m ² /m ³	1.0	1.5	1.0

It is apparent from the comparison table no. 3 that costwise or maintenance wise Soil Scape Filter is preferable to other technologies. In addition to this, the secondary biological (aerobic/anaerobic) systems give rise to the problem of sludge disposal. Unless and until it is stabilized further it can not be used as soil conditioner. But there is no such residue generated from the Soil Scape Filter. If there is proper selection

of green plants, there is no problem of foul odours or flies.

Conclusion

This Soil Scape Filtration System is applicable to household small units as well as to large scale units for colony or urban waste waters, which is economically feasible, socially acceptable and environment friendly.

References

1. Dr. Mehata Dinesh, Raghupati, Usha, Sharma, Rajesh, (1994) Squalor that need not to be. The Hindu Survey of Environment pg. 11.
2. Mehata, Dinesh (1995) Future Proteins - The Hindu Survey of The Environment Pg. 65.
3. Agarwal, G.D. (1996) Locationally distributed pollutional loads on rivers - Indian Scenario, Journal IAEM vol.23, Pp. 105-112.
4. Joshi, Sandeep (1989)
5. Joshi, Sandeep (1998) Pedobiological response in natural treatment of sewage, Proceedings of National Symposium on Eco-environment Impact of Organism Response, Siddarth Publications Amaravadi, India Pp. 10.1-10.4.
6. Joshi, Sandeep (1999) Process for developing Soil Scape Filtration Systems, submitted to patent office Mumbai no. 808/BOM/99.
7. APHA (1992) Standard Methods for the Examination of Water and Wastewater Analysis. 18th Ed.
8. Metcalf And Eddy (1990) Wastewater Engineering. Treatment Disposal Reuse. Revised by George Tchobanglous. 2nd Ed. Tata Mc Graw Hill, New Delhi. Pp. 706-707.
9. Pandey, G.N., Camey, GC (1991) Environmental Engineering, Tata McGraw Hill, New Delhi Pg. 120.
10. Casey, TJ (1997) Unit treatment processes in water And wastewater engineering, John Wiley and Sons, London.

Soil Scape Process In Comparison With Conventional Technologies

Sandeep Joshi

Technical Director, Shrishti Eco-Research Institute,
S.N. 36/1/1. M.N. 199. Vadgaon Khurd, Sinhagad Road, Pune 411 041.

Abstract

Applicability of the Soil Scape Process is proven through the installations of field scale units on domestic as well as industrial wastewater. It has been found that the Soil Scape Process filter can treat neutral wastewater typically in the range of 1-5 m³ per day per sq. m. area. with COD/BOD loading upto 5 kg per day per sq. m. area which is very competitive as compared to conventional aerobic and anaerobic system. All the processes such as biodegradation, bioconversion, biotransformation, bioutilization, simplification, detoxification, chelation, complex formation and assimilation occur in a single treatment unit when Soil Scape Filter is applied. But in case of conventional technologies, only heterotrophic microbes predominate the process of biodegradation which has its own inherent limitations of simplification, bioutilization, and detoxification of pollutants. Such limitations are not observed in Soil Scape Process, as it is cumulative eco-effect of activities of microbial floral and faunal consortia. This process harnesses the principles of ecological engineering to eco-remediate the organic as well as inorganic pollutants at micro-as well as macro-scale. This system has been found to remove heavy metals like Cr, Ni, Zn, Fe from the wastewater. On the other hand, they destabilize the conventional aerobic or anaerobic processes. Soil Scape Process is found very economical as compared to aerobic or anaerobic techniques, and also, it is confirmed that it requires less man-power and electricity. This indigenously developed technology requires only meticulous installation, selection of filtration medium and process initiation.

Introduction

Through the various lab scale, pilot scale studies and field scale installation, now it has been established that the Soil Scape Process and Filter developed by the author can be applied to various types of wastewaters^{1,2}. The consistency of results obtained is an indication of applicability of ecological principles to treat the wastes generated through the anthropogenic activities.

The application of ecological principles is comparatively newer approach than the use of conventional physiochemical aerobic and anaerobic treatment systems separately. These conventional techniques are being evolved from the last two centuries to treat the wastewaters³. But the success is partial - owing to the conversion of waste pollution from one form to another form. In the biological processes, the COD/BOD of wastewater are converted into biomass which is settled out in clarifier. The dissolved or suspended waste is converted into biomass.

The Soil Scape Process is found to be effective not only in removal of pollutants from the wastewater but in solid waste treatment also.

Aerobic/Anerobic Technologies and Soil Scape Process

Initially the aerobic or anaerobic technologies were developed to treat the organic matter which consumed dissolved oxygen - a vital element for aquatic life⁴. The strength of organic matter in water is measured in the

pollution analysis by COD (Chemical Oxygen Demand) and BOD (Bichemical Oxygen Demand). This organic matter is attacked by heterotrophic microorganisms which need organic carbon and energy source. Their population is the function of input concentration of utilizable carbon nad energy source.

The heterotrophic microorganisms are categorised into two main groups - aerobic and anaerobic. There are some other groups such as facultative and microaerophilic depending upon their adaptability to the surrounding environment⁵. The presence or absence of oxygen has a major role in bioconversion, biodegradation and biotransformation by heterotrophic organisms. Aerobic processes are simple and direct since the organic carbon is directly converted into carbon dioxide. But in anaerobic processes, there are numerous steps and conversions giving rise to various by products such as organic acids and gases like hydrogen sulphide, methane etc.

Many research workers have noted that the combination of aerobic and anaerobic processes can give better results in the wastewater treatment⁶. A series of treatment units comprising anaerobic microaerophilic and aerobic process can yield better performance as far as organic pollution treatment along with nitrate and phosphorus removal is concerned. It is observed that all these processes, occurring in different treatment units separately, can give cumulative effect in the single treatment of Soil Scape Process⁷.

Comparison of Conventional Technologies and Soil Scape Process

The Soil Scape Process can be compared with conventional wastewater treatment technologies based on the hydraulic as well as organic loading, power

requirement, nutritional requirement, ancillary units, treatment efficiency, merits, demerits, etc. Many workers have thoroughly studied and documented the aerobic and anaerobic technologies^{8,9}. The comparison is given in table no. 1

Table 1—Comparison of Soil Scape Process with other technologies

Sr. No. Particulars	Soil Scape Process	Conventional Technologies
1. Description	Ecofiltration through the biological activated soil	Biodegradation by heterotrophic microbes
2. Application	For domestic and industrial wastewaters, even for wastewater containing toxic organic and inorganic pollutants.	For domestic and industrial wastewaters containing non toxic organic matter only.
3. Hydraulic loading	1-10m ³ /m ² d	Activated sludge process- 1-3m ³ /m ² d Trickling Filter- 1-10m ³ /m ² d Lagoons/Ponds-0.1-1m ³ /m ² d Anaerobic Process-1-5m ³ /m ² d
4. Organic loading (COD/BOD)	1-5kg/m ² day	Activated sludge process 0.5 kg/m ³ day Anaerobic digester 0.5 kg/m ³ day Lagoons/Ponds-0.006-0.0025m ³ day
5. COD/BOD conversion (maximum)	80-99%	ASP Anaerobic Digester Lagoons/ponds 50-95%
6. Ancillary units	One unit only The requirement is of neutralisation if the pH of wastewater is not in the range of 6.5-8.5	4units Requirement of equalisation tank, neutralisation, primary settling and secondary setting tanks.
7. Destabilizing Factors	Continuous excessive hydraulic and pollutant loading Extremities of climatic conditions. Moderate effect of excessive toxic substances.	Any change in hydrolic as well as pollutant loading Any change in climatic factors like temperature etc.
8. Failures	Nil	Even small concentrations disturb the process.
9. Revival of the System	The system is restored within 4-10 days after complete process destabilization.	The system may take 15-90 days for restoration.
10. Key parameters of process	pH	pH. TSS.COD.BOD and toxic substances.
11. Maintenance	Simple	Skilled
12. Expenditure (calculated from 100 m ³ /day installation) Capital cost	Rs.4-6 per liter	Rs. 10-15 per litre (for low cost lagoons/ponds) Rs. 3-6 per litre)
Recurring costs	Rs. 12-per liter	Rs. 5-20 per litre (for low cost lagoons/ponds) Rs. 0.5-2 per litre)

The basic prerequisites or expectations from the wastewater treatment technologies are listed below —

- Less captial and recurring expenses (inclusive of civil, mechanical works and culture development)
- Minimal requirement of electricity, material inputs and skilled man-power
- Minimal moving parts in the system, so that maintenance should be reduced
- Better output as per the standard norms; acceptability as per the characteristics of the receiving water body or soil.

- It should not give rise to another form of pollution or nuisance, or residue disposal problem
- System should be less sensitive to occassional changes in hydraulic or pollution loading or it should restore with minimal inputs or efforts when it receives shockloadings
- System should be resistant to occassional release of toxic substances
- As far as possible it should generate revenue in the form of clean water for reuse, biomass or some by-products like biofertilizer etc.

It is observed and tested for more than six years that as compared to the conventional technologies, the ecotechnological Soil Scape Process fulfils many of the expectations. Though the anaerobic systems can generate revenue through the production of methane gas, about 50% of it is spent on maintenance of the system only. In the case of Soil Scape Process, it is experienced that this proportion is less than 5%.

Conclusion

The indiginously developed technology using ecological principles - the Soil Scape Process has wider applications and acceptance as compared to the ever-experimenting conventional technologies in the field of environment pollution control and the restoration of environmental quality.

References

1. Joshi, Sandeep (1998) Pedobiological response in natural treatment of sewage. Proceedings of National Symposium on Eco-environment Impact of Organism Response, Siddarth Publications Amaravati India Pp 10.1-10.4
2. Joshi, Sandeep (2000) Soil Scape Process for the treatment of electroplating wastewater containing heavy metals. In Print.
3. Stevenson, David G (1998) Water Treatment Unit Processes. Imperial College Press, London. Pp. 2-9.
4. Montgomery, James M (1985) Water Treatment Principles and Design. John Wiley and Sons Inc., New York. Pp. 7-10.
5. Pelczar, Michael J Jr., Chan, ECS and Krieg, Noel R (1986) Microbiology. 5th Ed. McGraw Hill International Editions, Singapore, Pp. 109 -110.
6. Rendell, F. (1998) Water and Wastewater Project Development.
7. Joshi, Sandeep (2000) Environmental Biotechnology in Pollution Control. Proceedings of National Conference on Environment Monitoring held at Chalisgaon Dist. Jalgaon, Maharashtra State on Dec. 23-26, 2000. Pp. 21-34.
8. Metcalf And Eddy (1990) Wastewater Engineering. Treatment Disposal Reuse. Revised by Geore Tchobanglous. 2nd Ed. Tata McGraw Hill, New Delhi. Pp. 468-570.
9. Wheatley, A.D (1990) Anaerobic digestion : industrial waste treatment. In Anaerobic Digestion : a Waste Treatment Technology Ed. A D Wheatlye. For SCI published by Elsevier Applied Science. Essex Pp. 171-223.

The Upgradation of Industrial and Domestic Waste water — A Case Study

T. K. Bose

B.Sc, M. Tech, MIE, Chartered Engineer,
Ex-Faculty Member, USIC, J.U. Calcutta-32.
At present Technical Consultant Life Member of IE(I),
and Indian Vacuum Society, Member of IWWA,
Life Fellow of I.P.H.E. and Alumnus of ISM, Dhanbad.

Abstract

A famous food processing industry is engaged for making different types of sweet products, syrups, different grades of bhujias of export quality, fried vegetable products and other meal and dinner food items. etc. The unit is well established by the manpower and semi-automatic modern & imported plant & machineries along with showroom & sales counter. A considerable quantity of water is consumed for processing food products and also for domestic purposes. The effluent generated in the unit is mixed industrial & domestic combined.

The raw effluent discharged from the factory contains high oil & grease and suspended solids with varying BOD & COD load. The effluent treatment plant includes primary /pre-treatment which consists of screen chamber followed by an oil & grease trap for separating free floating oil & grease. Secondary treatment consists of two-stage activated sludge process followed by secondary settling, flocculation & coagulation systems.

The treatment plant is primarily designed for 35 cum/day for the raw mixed effluent coming out from the factory, but at present effluent load is 70 cum/day. Thus, in the aeration tank the addition of cow-dung, external sludge during stabilization period is not suitable to comply the economic viability at this stage, so the special bacteria culture: - Microbe - Lift i.e. live bacteria digestant, which consists of mixture of aerobic, anaerobic and facultative bacterial strains, is used from the beginning of commissioning step. 6.5 ltrs. of bacteria is introduced in the aeration tanks for first 15 days, keeping the inlet flow minimum and the bacterial growth is also controlled by the dosing of chemicals and phosphate & Urea, time to time. At the end of 10th day, the growth of Microbe-lift is attained 3000 mg/L, which is the designed value. Outlet characteristic is measured at the end of 15th day, which shows COD <213 mg/L from inlet COD-2505 mg/L. The sludge volume measured is 8000 mg/L at the recycle line to aeration tank.

The organisms are non-toxic and non-pathogenic, natural product and also harmless to human, animal, plant, aquatic and marine life. The bacteria have been cultured for compatibility to feed on the same media and reproduce themselves to grow into their adult form.

In case of normal activated sludge process, cow-dung @ 50-100 kg./day is required for almost 15-20 days for proper stabilisation, but in case of bacteria culture, the effluent treatment plant is stabilized much early i.e. within 10 days with minimum monitoring of the plant and further, the plant can also handle a flow of 70 cum/day (maximum) with respect to the designed value of 35 cum/day, which is not possible in case of normal activated sludge process to maintain twice the normal flow per day.

Only the cost of stabilization includes Rs. 12000/- to Rs. 24000/- per year excluding the bacteria price.

The advantage of using the bacteria includes minimum sludge discharge/day, reduction in the sizes of aeration tank itself, since this bacteria can take twice the normal flow/day, no smell & no maintenance, as in case of normal activated sludge process.

Introduction

The Technological status of the food processing industry is modernised with economic liberalisation and increase of competition. The upgradation of technology is taking place, which delivers better quality product, higher yield using lower energy and manpower resources and similarly, processes are being developed to convert waste into disposable quality. Thus, the effluent treatment plant of the above food processing industry is stabilized using special type imported bacteria culture along with primary & secondary settling, flocculation & coagulation.

The micro-organisms are a mixture of aerobic, anaerobic and facultative bacterial strains. It is nontoxic and non-pathogenic & it is purely a natural product, which is also harmless to human, animal, plant, aquatic

and marine life. It does not contain any culture, which have been genetically engineered or, manipulated. The bacteria have been cultured for compatibility to feed on the same media and reproduce themselves to grow into their adult form. When, reproduction is complete to after incubation, the bacteria become dormant and remain in this state for a long period of time. When introduced into polluted area, the bacteria will immediately revive and being feeding & reproducing while attacking the material in the water that causes the pollution.

The above food processing industry is in process of making different types of sweet products, syrps & different grades of bhujias of export quality. The complete operation includes receiving of raw materials, processing, frying, drying & packaging. The analysis of

raw effluent discharged from the factory is :

pH	:	9.5
BOF mg/L	:	800.0
COD mg/L	:	1000.0
TSS mg/L	:	150.0
Oil & Grease mg/L	:	400.0

Objective of the Study

The objective of the present study is to establish a commercially viable Effluent Treatment Plant by the Activated Sludge methodology. Here, the infrastructural facility of local authority i.e. drainage system for the collection of industrial waste-water as well as domestic waste-water is none, except a lagoon by the road side belonging to state government. Thus, waste-water generated from the said food processing industry can not be discharged as such, into the lagoon except proper treatment for maintaining ecology.

The free floating oil & grease has been separated primarily and thereafter, waste-water along with the septic tank discharge is taken in the aeration tank for the secondary treatment. Since the quantity of effluent becomes double than the initial estimation, the activated sludge is facilitated by the bacteria culture i.e. Microbe-Lift, keeping the size of treatment plant as original.

The Treatment Process.

The treatment process consists of a manually cleaned Bar Screen Chamber. The initial removal of coarse solids is done by a Fat Removal unit, where the oil & grease float to the top & is being skimmed off manually to a sidepit. Water then overflows to a collection Tank for homogenisation. The effluent from the Collection Tank is transferred to the Aeration Tank by Pump.

In the aeration tank-I, the flocculating &

coagulating agents - lime & alum are added adequately, so that the p-H of effluent becomes in the range of 7 to 8. Recycling of mixed liquor is followed as per need. Now overflow of aeration tank is passing to aeration tank-II, where submersible floating aerator provides necessary oxygenation and mixing in the tank.

The organic matter is removed by micro-organisms suspended in the liquid waste, thus reducing the BOD & COD loads considerably. From aeration tank-II, the effluent is gravitated to the settling tank for removal of suspended solids.

The underflow sludge from the settling tank is recycled back to the aeration tank-I with part being discharged periodically to the sludge drying beds and the overflow being discharged to the drain via a v-notch chamber.

Result and Discussion

The characteristic of raw mixed effluent at different times of a particular day by the help of sample collection and laboratory analysis :

Time	Grab 8A.M.	Sample 10 A.M	Composite Sample from 11 A.M. to 6 P.M.
pH	6.61	6.63	5.64
BOD, mg/L	373.95	368.79	586.57
COD, mg/L	1110.2	958.54	3486.16
TSS, mg/L	440.0	280.0	1113.33
Oil & Grease mg/L	139.0	141.0	129.0
Nitrogen (as N) mg/L	44.4	37.24	40.2
Phosphorus (as P) mg/L	27.5	26.12	16.6
TDS, mg/L	950	712.0	613
Nitrate (No ₃), mg/L	0.54	0.62	4.21

Special type of bacteria i.e. Microbe - Lift (live bacteria digestant) is introduced in the aeration tank-II from commissioning stage without addition of cow-dung/sludge. The bacteria dosing schedule & result obtained are as follows :—

Sl. No.	Day	Bacteria Dosed	MLSS Developed	Colour in the Tank
1.	1st	1 Lit.	—	Same as effluent.
2.	3rd	1.5Lit.	(5CC in 100CC measuring cylinder) 500 mg/L (assumed).	Slightly Black.
3.	6th	1 Lit.	(15CC. in 100CC. measuring cylinder) 1200 mg/L (measured)	Slightly Brownish.
4.	9th.	Nil.	(28CC. in 100CC, measuring cylinder) 2745 mg/L (measured)	Chocolate Brown.
5.	10th	1 Kit.	(30CC. in 100CC. measuring cylinder) 3200 mg/L	Chocolate Brown.
6.	11th	1 Lit.	(32CC. in 100CC. measuring cylinder) 3400 mg/L (assumed)	Chocolate Brown.
7.	12th.	1 Lit.	(40CC. in 100CC. measuring cylinder) 4200 mg/L	Chocolate Brown.
8.	17th.	Nil.	(42CC. in 100CC. measuring cylinder) 4500 mg/L (measured).	Chocolate Brown.

Total Bacteria Dosed : 6.5 Litres.

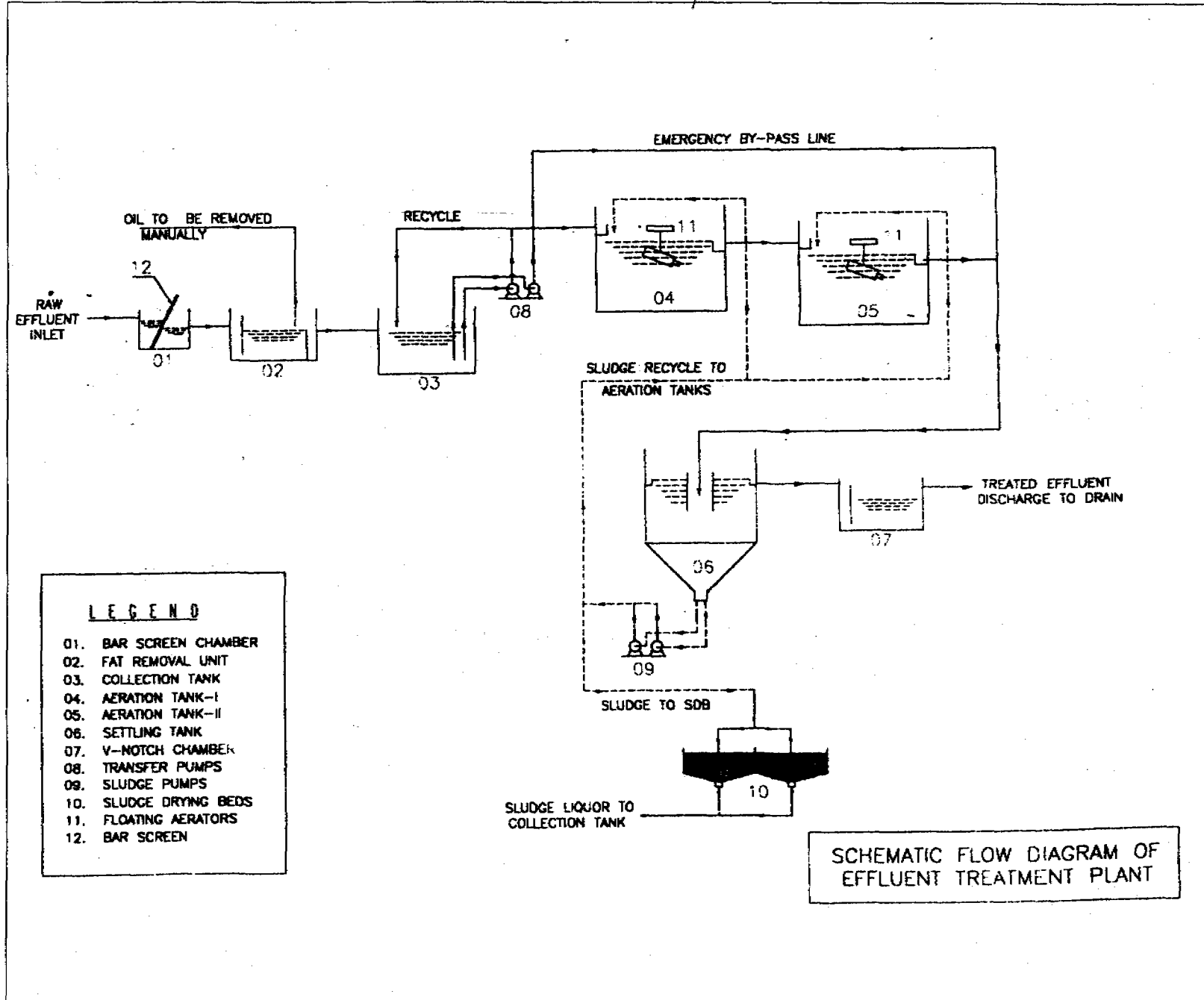

- LEGEND**
- 01. BAR SCREEN CHAMBER
 - 02. FAT REMOVAL UNIT
 - 03. COLLECTION TANK
 - 04. AERATION TANK-I
 - 05. AERATION TANK-II
 - 06. SETTLING TANK
 - 07. V-NOTCH CHAMBER
 - 08. TRANSFER PUMPS
 - 09. SLUDGE PUMPS
 - 10. SLUDGE DRYING BEDS
 - 11. FLOATING AERATORS
 - 12. BAR SCREEN

SCHEMATIC FLOW DIAGRAM OF EFFLUENT TREATMENT PLANT

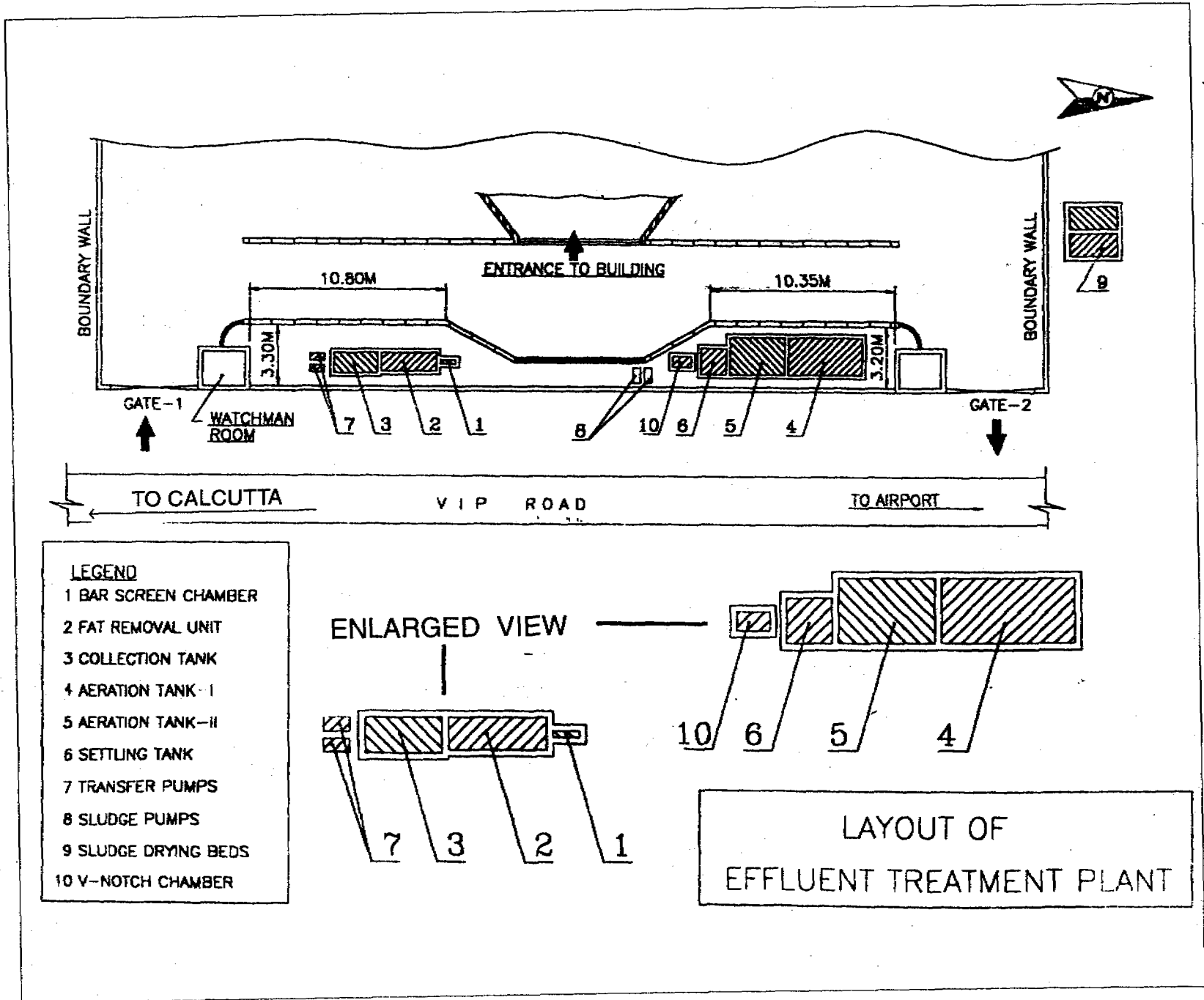

- LEGEND**
- 1 BAR SCREEN CHAMBER
 - 2 FAT REMOVAL UNIT
 - 3 COLLECTION TANK
 - 4 AERATION TANK - I
 - 5 AERATION TANK - II
 - 6 SETTLING TANK
 - 7 TRANSFER PUMPS
 - 8 SLUDGE PUMPS
 - 9 SLUDGE DRYING BEDS
 - 10 V-NOTCH CHAMBER

Immediate after the addition of bacteria on 1st day, no effluent was taken till 7th day for the stabilization of Micro-organisms- MLSS. On 8th day, the following chemicals were dosed for rapid growth of Microbe - Lift.

(ZnCl₂ of 2.5 kg, CaCl₂ of 2.5 kg, MgSO₄ of 2.5 kg. & MnSO₄ of 100gm.) Colour of the effluent was turned to Chocolate Brown A rapid growth of MLSS was observed in 9th day measuring 28CC. in 100CC. measuring cylinder. A sample of effluent was analysed and MLSS was found 2745 mg/L.

From 10th day, effluent of 2 cum./hr for daily 3 hours was taken into the aeration tank-II. Colour of the effluent was turned chocolate brown. Fresh MLSS of 1 Lit was also dosed in aeration tank-II, as the settling property of sludge was not at the required level (30CC. in 100CC. measuring cylinder). The dosing of effluent and bacteria were followed as above practice for next two days. On 12th day, MLSS was rapidly increased and settling property of sludge was also at the required level (40cc. in 100cc. measuring cylinder, which indicates MLSS of 4240 mg/L.)

On 13th day, 1 lit. of sample from aeration tank-II was taken for laboratory analysis and that shows outlet COD is 213.00 mg/L. whereas inlet average COD is 2505.45 mg/L. So, after 12 days COD reduction obtained is 91.5%.

From 14th day, continuous effluent of 3 Cum/hr. was taken into the aeration tank. Colour of the effluent was Chocolate brown. Urea of 1 kg./day & super-phosphate of 500 gm./day was dosed intermittently.

After 17th day, the analysis result of the overflow sample of V-notch chamber is

p - H	: 7.52
BOD, mg/L	: 28.5
COD, mg/L	: 224.0
TSS, gm/L	: 98.0
Oil & Grease, mg/L	: 10.0

1 Lit. of sample from aeration tank-II was also taken for analysis and so, MLSS in aeration tank-II was found 4500.0 mg/L.

After 2 months a sample from the final outlet was

again analysed for the following parameters;

		<u>Discharge Norms.</u>
p - H	: 5.9	6 - 9
BOD, mg/L	: 26.05	<30.0
COD, mg/L	: 232.85	<250.0
TSS mg/L	: 92.0	<100.0
Oil & Grease	: 8.0	<10.0
MLSS in aeration tank-II, mg/L	: 4663.0	

From the above analysis, it can be said that within 17 days the treated Waste-water attains the discharge norms with design MLSS value taking the twice load of flow.

The advantages of using the bacteria includes the followings:-

- No Cow-dung/external sludge requirement.
- Quick start-up of effluent treatment plant.
- Less sludge generation & minimum sludge discharge per day.
- Reduction in the size of Aeration Tank itself, as these bacteria can develop MLSS as high as 500 mg/L in such Aeration tank.
- No bad and offensive odour from Aeration Tank/ Sludge Drying Bed as in case of normal Activated sludge process.
- Minimum maintenance in respect to normal Activated Sludge process.

Conclusion

The effluent treatment is tailormade job. It may be mentioned here that a little treatment of the effluent from each stage/ process can eliminate many major treatment.

Acknowledgement

- Sri P. S. Agrawal, M.D., M/s Haldiram Bhujawala Pvt. Ltd., VIP Road, Calcutta - 700 052.

References

- Industrial Pollution Control Handbook : Edited by Herbert. F. Lund. Published by - McGraw Hill Book Company, New York. etc - 1971.
- Chemical Processes in Water treatment by W. T. Eilbeck and G. Mattcock Published by - Ellis Horwood Limited, Halsted Press, a division of John Wiley & sons - New York - Chichester, Brisbane, Toronto - 1987.
- Handbook of Water Purification by Walter Lorch Published by McGraw Hill Book Company (UK) Limited - 1981.
- Wastewater Treatment for Pollution Control (2nd Edition). Published by Tata McGraw Hill Publishing Company Limited (New Delhi)- 1986.
- Wastewater Engineering Treatment, Disposal, Reuse (3rd Edition) Published by Tata McGraw Hill Publishing Company Limited (New Delhi)-1995.

Performance Evaluation of Oxidation Pond at R.E.C Campus, Hamirpur

Moti Ram Sharma

Assistant Engineer
Irrigation & Public Health Department
M-26, Housing Board Colony, Hamirpur,
Dist. Hamirpur - 177001 (H.P)

Abstract

The paper presents the results of critical performance evaluation study of Oxidation Pond at R.E.C. campus Hamirpur (H.P.) Sewage collection and transportation system of R.E.C. campus is a gravity system. The treatment system - consists of an Oxidation pond. The oxidation pond has been designed to treat an average flow of 0.27 mld. The salient features of the pond, physico-chemical characteristics of sewage and effluent after treatment are presented along with discussion on pond performance. In the light of the performance appraisal, practical measures are suggested to improve the performance and to achieve the desired results.

Key Words: Oxidation Pond, Wastewater treatment

Introduction

Water pollution is one of the most horrible crises to which we are subjected today. Wastewater of the urban areas or the institutions located separately has been a major environmental problem everywhere. The collection, transportation, treatment and disposal of wastewater is an important component in the protection of public health and environment. Regional Engineering College Hamirpur is situated on the outskirts of Hamirpur town on Dharamshala - Shimla National Highway No. 88. The main attraction of the area are chir pine (*Pinus roxburghii*) forests and its undulating surroundings, which indeed unfold massive natural beauty. The area lies at 31°-25' N of latitude and 76°-19' east of longitude in Shivalik hills of Himalayas. The rainfall of the area varies from 1200 to 1900 mm per year. The average temperature in the region during day hours varies from 35°C to 42°C in summer and from 0°C to 10°C in winter during night hours. The R.E.C. Campus is situated at an altitude of 800 m from mean sea level.

To treat the domestic wastewater from hostels, staff colony canteen and various laboratories, an oxidation pond was constructed in 1993. The pond was designed as a shallow aerobic pond to treat 270 cubic meter of wastewater per day. The pond has two compartments in series at a level difference of 0.5m (Fig. 1) The pond has been constructed by cutting on a sloping ground. The deciduous chir pine trees surround the pond on all sides.

Materials and Methods

The observations reported were carried out in the month of September, 1998 to January, 1999 for 5 months. The data was obtained from analysis of grab samples collected every week in the forenoon. The samples were also examined periodically round-the-clock for D.O. determination to find out whether the

biological cycle in the pond is normal or not. The samples were collected from different points from influent to effluent end in the pond and examined for D.O. BOD, pH, turbidity etc. in the laboratory as per Standard methods (1) The size of the pond was measured at site and found as 2552 square metres.

Results and Discussions

Characteristics of Influent

Flow of Water: The water is being supplied to the R.E.C campus by the Irrigation and Public Health Engineering department at the rate of 300 cubic metres per day. Taking 80% as flow of wastewater, the volume workout to be 240 cubic metres per day, however no flow measurement device has been installed at site.

pH value: pH of raw sewage varied between 7.47 to 7.67

Biochemical Oxygen Demand: the B.O.D. of the filtered sample varied between 260 mg/L to 310 mg/L. The average total B.O.D. of unfiltered sample was sample to be 385 mg/L.

Total solids : The amount of total solids in raw sewage varied from 1100 to 1450 mg/L.

Characteristics of effluent

- 1. Temperature:** The temperature of waste water in the pond has been found to vary from 26°C to 19°C during the period under observation and lowest value found in the month of January.
- 2. pH value:** the pH value has been found to vary from 5.35 to 6.81
- 3. Dissolved Oxygen:** It has been found that the D.O. level in the pond during the night and early in the morning and in the evening is almost zero. The D.O. level in the pond even at noon never goes beyond 2.6 mg/L. Kharkar and others (2) have

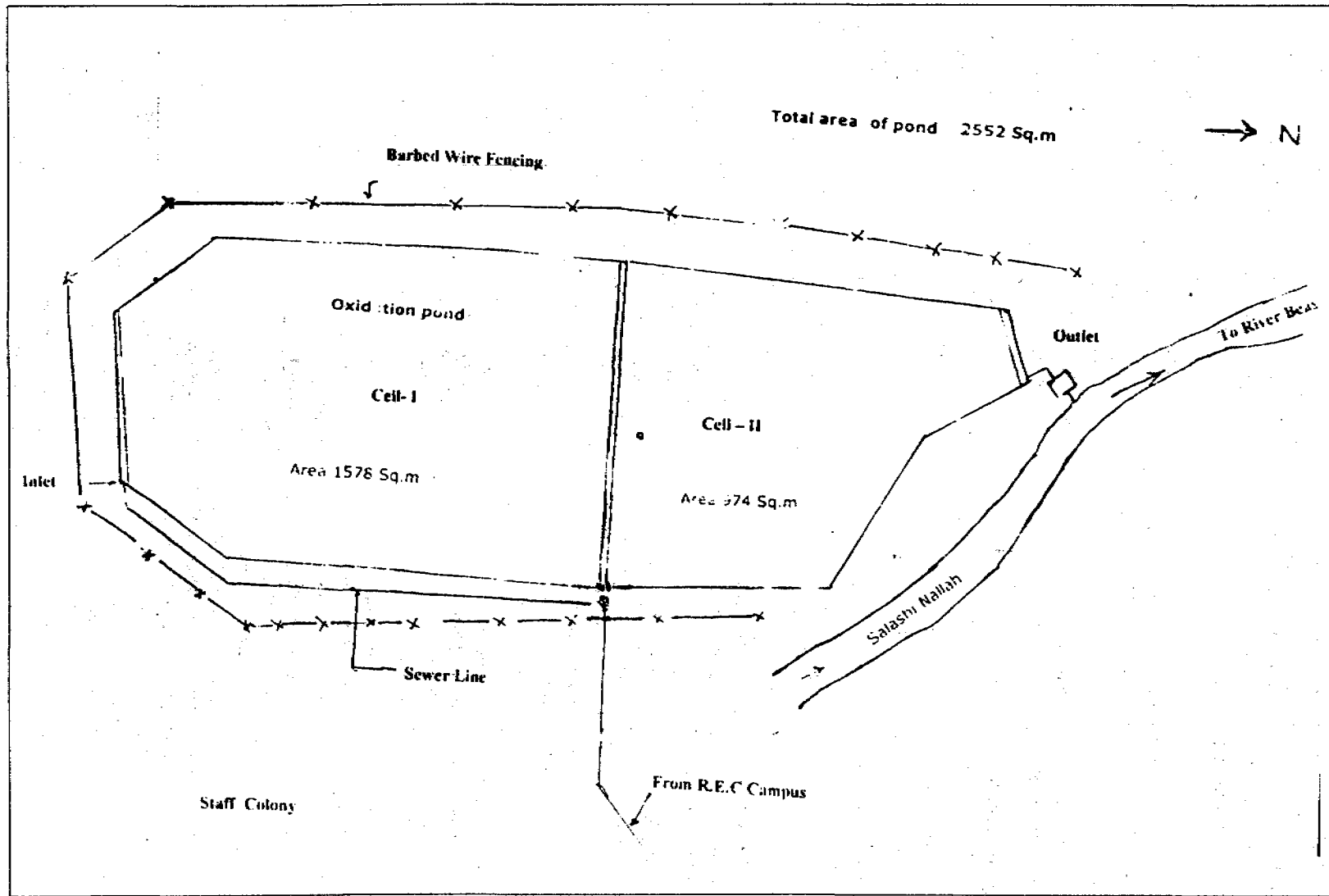

Fig. 1—Plan of Existing Oxidation pond at R.E.C. Campus Hamirpur

shown in a study that D.O level in the oxidation pond can go up to 15 to 18 mg/L during day hours. As the D.O level in the pond never goes beyond 2.6 mg/L during day hours, it is clear indication that the photosynthetic activity in pond is not going on well.

4. **Biochemical Oxygen demand:** The B.O.D. of the filtered effluent sample has been found to vary 120 to 150 mg/L
5. **Turbidity:** The turbidity of the effluent has been found to vary from 80 NTU to 290 NTU at noon.
6. **Total solids:** The total solids of the effluent has been found to vary between 1200 to 1250 mg/L
7. **Total Dissolved Solids:** The total dissolved solids has been found to vary between 700 to 750 mg/L
8. **Algae Identification:** The dominant species of algae in the month of August and September was *Chlorella*. The other algae found are *Spyrogyra* and *Anacysts*
9. **MPN of Total Colliform:** The MPN count of the pond effluent shows that the wastewater is not fit for disposal into surface water.
10. **Colour:** The colour of the pond was found to vary from light brown in the month of August and September to dark grey in the month of October and November and finally black in the month of December and January. Floating scum and mat of dead algae were observed in the pond.
11. **Odour:** Very strong odours were noticed during the month of September and October and the intensity of malodour decreases gradually in the month of November and December.

Other Findings of the study: No flow measurement device has been installed at site of pond. No grit chamber and bar screen have been provided at the pond site. There is no facility to test the wastewater sample at the site of the pond. The wastewater samples were got analysed only two times after the commissioning of the pond. The pond presents an ugly look and no efforts have been made to provide beautiful landscape, lawn or garden around the pond. There is no proper inlet and outlet chamber for the pond. The pond has not been properly fenced. No caution board has been hung to indicate that it is an Oxidation Pond to treat sewage. The problem of mosquito breeding, flies and weeds have been observed at pond site. The pond is situated in a dip constructed by excavating the

earth and unobstructed wind-sweep across the pond is not available. It has been observed that the pond is not directly exposed to sun to have maximum amount of sunlight. The direct sunlight falls on the pond during day from 11 O'clock to 3 O'clock only. It has been observed at site, that pond is surrounded by Chir Pine trees on all the sides. The Chir Pine being a deciduous tree, in the autumn and summer season the dry leaves of these trees fall in to the pond, and add heavily to the organic loading i.e. BOD in the pond. The Chir Pine trees also cast shadow near the pond. It has been observed that there is R.E.C. staff colony on east at a distance of 300 m and Radio station at a distance of 250 m on the south side of the pond.

The existing pond has been designed as an aerobic oxidation pond. The depth of pond has been kept as 0.45 m. No primary treatment has been provided there by large quantities of solids are settling to the bottom of pond forming sludge larger. Sludge build up is a problem in aerobic ponds because methanogenic organism which are strict anaerobes are normally unable to establish itself to any significant extent. The length to width ratio of the pond has been found to be 2.5

During the month of December & January the temperature of water in the area reaches about 5°C. As an aerobic pond is designed to maximise algal production, the effluent from such a pond contains high degree of concentration of algal cells. Effluent limitations required for secondary treatment are 30mg/L or less for both BOD₅ and suspended solids. As a consequence supplemental treatment of pond effluent is required, which is costly and requires operational skills. The aerobic ponds have been considered where ultimate harvesting of algae is desired but their use has not been widespread in waste treatment. From the above facts it is clear that the pond should have been designed as a facultative stabilisation pond and not an aerobic pond.

The pond has been constructed amid chir pine forest. Chir pine trees interfere with the performance of the pond by obstructing light falling on the pond. The pond is situated in a dip artificially constructed. The location of site and trees obstruct the wind sweep across the pond thereby reducing the natural aeration. No consideration has been given to the availability of land for future expansion of the pond.

The effluent from the pond is being discharged in a nallah which is catering need of about 10000 persons for drinking water. As the effluent from pond contains high BOD, the quality of treated and disposed effluent is not consistent with local water quality objectives. At the time of designing the pond's adverse environmental impacts have not been considered.

Conclusions

It has been concluded that the working of the pond is not satisfactory and anaerobic conditions are prevailing in the pond. BOD removal efficiency is only 50-58%. BOD loading is 91.20 kg per day at present, whereas the BOD loading rate taken in the original design is 81 kg per day. The effluent coming out of the pond was black in colour exerting very high BOD values of 80-110 mg/litre (filtered samples), pH of samples varied between 5.35 to 6.81. The performance of the pond was badly affected.

Dissolved Oxygen during the daytime was only 2.6 mg per litre and during night and afternoon no D.O was observed in the pond. The pond was creating a problem of water pollution downstream the outlet of the pond and was also creating nuisance from odour and mosquito.

Acknowledgements

The author wishes to thank Shri Desh Raj Sharma for his sincere contribution in the analysis of wastewater samples. The author is also highly grateful to Prof. A.B. Gupta, Head, Civil Engineering Department, M.R.E.C. Jaipur for his guidance during study and also thankful to Mrs. Kamala Sharma for typing the manuscript.

References

1. APHA (1989) :Standard Methods for Examination of Water & Wastewater 18 Ed published by APHA, AWWA & WEF.
2. Kharkar C.B. Venketashan T.L. and Tiwari A.R (1969) "Review of Performance of the Stabilisation Ponds at Bhilai" A symposium on low cost Water Treatment CIPHERI Nagpur pp 70-77

In-Situ Treatment of Sewage in Urban Storm-Water Drains

Mrs. Almitra H. Patel

Convener, Intach Waste Net work & Member Supreme Court Committee
or solid Waste Mgt for class 1 cities.

In all Indian cities, sewage flows illegally into storm-water drains which were formerly natural water-courses. So all of these empty today into rivers, lakes or city water-bodies, polluting them and causing eutrophication. At the same time, being designed for rain-water, no provision was ever made, or is today possible, for sewage treatment plants at the tail end to handle these polluted flows.

One solution is Decentralised Sewage Treatment (DST), using the area of the storm-drain itself for the purpose. Given India's poor track record of operation and maintenance of facilities, and frequent power interruptions which interfere with steady operation of conventional STPs, these DSTs should be zero-energy natural systems or low-energy-consuming solutions, requiring very low capital cost and minimal maintenance.

DST can take the form of root-zone treatment cum recreational urban garden-ribbons within storm-drains having low summer flows. Pune's Nala Bagh at Koregaon Park is a superb example. Pimpri-Chinchwad, nearby, has cleaned up four polluted nalas and quarries with similar garden treatment. For water-bodies with wide banks, reed-beds can be designed at the polluted water entry points.

Duckweed-aquaculture (DWA) is possible and advisable in more perennial storm drains with large volumes of polluted water, or where high water-tables make septic tanks unsuitable. Done along the entire nala length from start to finish, this can also provide some protein nutrient to slum communities bordering the polluted storm-drains, while cleaning them up as well. Cuttack would be an ideal location for this, as it

has first-hand experience of a 1 mid DWA, and CIFA Bhubaneswar nearby can provide technical monitoring for this field-scale effort.

Where booster-pumps are used to move storm-drain water along the system, as in Delhi, Faridabad and the Gangetic plain, these booster pumps and locations can be fitted with a Venturi system /ejector arrangement to draw air into the pumped sewage for oxygenation, and to lift water to the top of a trickling bio-filter at that site. This can be done at very little additional cost at each booster-pump station, and will give some improvement in water quality, even if it is not to prescribed standards at that point, thereby giving some environmental relief to downstream residents and a cumulative clean-up effect.

Compact DST units with a small foot-print can also be constructed on a slab over part of the storm-drain, if the treated water can be used nearby for a car-wash or park or golf course. Economic incentives and encouragement should be given to companies now purchasing raw water, if they instead treat and use sewage from nearby open storm-drains. This is being done by a recycled-paper mill in Bangalore. The Water-Supply Boards' reluctance to permit this for fear of losing their high-priced water revenues is an extremely short-sighted approach and against the broader interest of urban residents, environment and the nation.

Similarly, bifurcation of sewage and sullage (black water and gray water) and on-site treatment and re-use of sullage in all large residential and commercial complexes should form a mandatory part of urban plan sanctions.

Calcutta Drainage —A Problem

Tarit Kumar Mukhopadhyay
Dy. Chief Engineer. (Civil)
The Calcutta Municipall Corporation

Calcutta City established in 1690 by the Britishers was once the Capital of British ruled India, Like other megapolis of the developing world, it has also the inherent deficiencies of public health infrastructure. The situation is gradually becoming more and more deficient to offer proper service of the huge growth of population, inadequate pace of development, lack of adequate maintenance, change of Urban Land use, increasing quantum of precipitation with high intensity leads the city prone to more numbers of flooding. Practically there is no maintenance of the outfall canal and unauthorised settlement on the bed and in their bank is restricting the flow and capacity of the disposal of storm water. The siltation of river Ganga and gradually rising high tidal level are few which add further feathers to the distress.

With an area of 187.33 Sq.km the Calcutta City is divided into 141 wds. and 15 Boroughs. Out of 141 wds. Ward 1-6 and 101 to 141 are practically devoid of any sewerage and drainage worth its name. The core city i.e, wd 7 to 100 has the facility of drainage and sewerage system catering about 92.0 Sq. Km.

The core city slopes away towards east from the bank of the river and it is lowest along an imaginary line more or less running from north to south which has given the city the shape of a saucer as a result of which every drop of water is to be pumped out.

The city experiences on an average 165- mm. of rainfall per year out of which 90% precipitation is experienced between months of May to October and 70% between June to September. So the days between June to September experience heavy rainfall.

The Calcutta sewerage and drainage dates back to 1876. Due to its topography as stated earlier all the major trunk sewers are running from west to east i.e., Summits are near the river Ganga having arrangement of overflow to the river and are intercepted by an interceptor sewer after which it goes to the pumping station from where it is pumped for its ultimate disposal to river Kulti through open channels specially constructed for this purpose. The combined system has been designed for 6.5 mm (1/4 inch) and 4.5 mm. (1/6 inch) intensity of rainfall per hour with 100% runoff. As such the capacity of sewer is sufficient for D.W.F. of the city having an estimated population of 44.0 lakhs and a floating population of 22.0 lakh, but the system is absolutely inadequate for tackling storm runoff which

in September '99 was about 30 mm. per hour for about 10 hrs. non-stop which led to a catastrophe effect on the city life. The condition has been further worsened due to highest tidal level of the river not only restricting the overflowing but also ingress of river water through those leaky gates of the overflow arrangements.

Apart from above, the major trunk and interceptor sewers, being more than a century old has already lost its hydraulic capacity alarmingly in the wake of massive siltation and had become structurally unsafe. Due to 'Water Decade' programme of U.N. much attention has been paid to augment the supply in the third world countries but no attention to that extent has been given in Sanitary Sector including safe disposal of liquid waste. In calcutta also water supply of the city has been increased from 6 mgd. to 250 mgd. and is likely to reach 330 mgd shortly apart from about 75 mgd of unfiltered water supply but no such programme has been taken till 98-99 for further development of drainage and sewerage sector.

The drainage pumping stations numbering 21 have about 100 nos. pumps. Most of them are more than 60 years old and has outlived their designed life, and needs immediate replacement. The existing trunk sewers about 200 Km. needs immediate structural and hydraulic rehabilitation.

From the above picture it is evident that if all the rehabilitation takes place even then the city will get flooded if the rainfall intensity exceeds 4.5/6.5 mm. per hour which the city experiences frequently during last few years.

In seventies Calcutta Metropolitan Development Authority, tried to increase the design rainfall intensity conforming to two months frequency i.e. to allow maximum of six flooding of the streets in a year, but failed to achieve the desired level due to various reasons. Though in general the average annual rainfall is 1650 mm. during recent past much higher quantity of rainfall has been observed.

1977	—	2067.00 mm
1978	—	2222.25 mm
1984	—	2209.00 mm.
1986	—	2084.00 mm.
1990	—	2135.00 mm.
1999	—	2129.41 mm

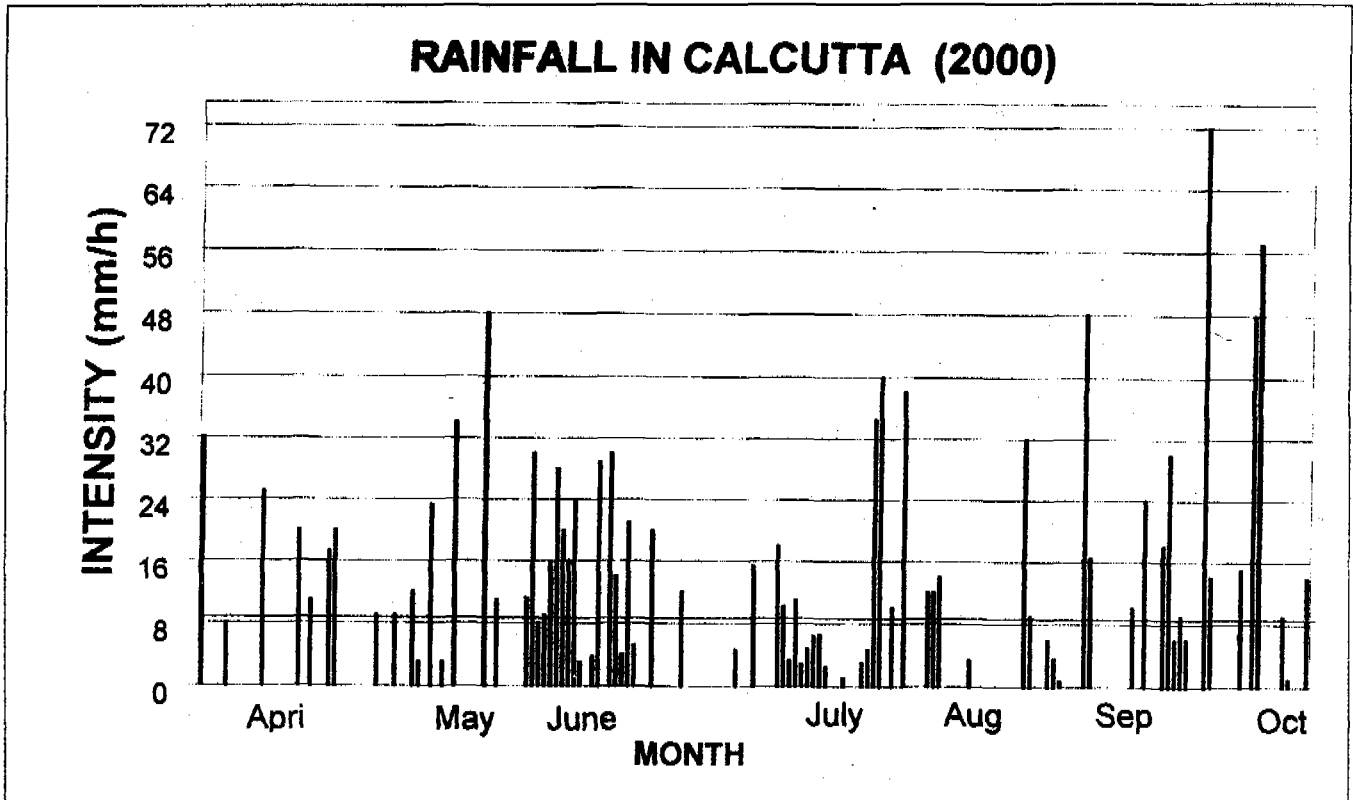

Not only the total quantum has been increased on the above years the some of the rains are of much higher intensity and duration.

5.6.84	—	340.25 mm.
25.9.86	—	263.00 mm.
25.8.87	—	171.00 mm.
26.6.88	—	249.00 mm.
24.9.99	—	292.00 mm.

The above rainfall occurred within 10 hrs. which is much higher than that of designed capacity of Calcutta sewerage and drainage system leading to the flooding of the city. Even the rainfall recorded in the year 2000 shows several precipitation much above the designed intensity 4.5 mm/6.5 mm. per hour and city streets got flooded.

However, considering all the factors for flooding, the deptt. identified the areas, within the core city, which are very prone to flooding even with a moderate rains and remain waterlogged for long hours even when other areas are free of water logging.

In taking advantage of existence of the canal system present within the city, the deptt arranged to

free those areas from prolonged and frequent water logging by constructing small capacity pumping station. The rain water is thus pumped to the nearest natural outfall without allowing them to travel to the original pumping station by intercepting the storm water either by construction of a separate storm sewer or by receiving the overflows from the existing sewers.

This method not only helps to reduce the flooding but also helped to reduce the load of the existing trunk sewers and pumping stations. The deptt. has already constructed two such pumping stations and remodeled one existing station and found the same to be very effective in reducing the flooding condition. The construction of two more small pumping stations and re-arrangement in two existing pumping station are under consideration.

Thus the cities like Calcutta having age old sewerage & drainage system need to be supplemented by separating it from its original outfall system to a new one in particular for its adequate drainage facilities to prevent frequent and prolonged flooding provided there are existence of natural outfall for getting facilities of draining our the strom water separately.

Experience on Use of Duckweed in Low Cost Waste Water Treatment

JN Shome

Institution of Public Health Engineers, India

SK Neogi

Institution of Public Health Engineers, India

AK Balshya

Titagarh Municipality

Abstract

The role of hydrophytes like water hyacinth (*eichhornia crassipie*), duckweed (*lemna, spirodella*) in reduction of impurities in waste water is recognised as potential alternative in low cost waste water treatment. Application of water hyacinth in waste water treatment on commercial scale is not very popular due to handling difficulties. In case of duckweed the cultivation round the year in nutrient enriched municipal waste water was not possible. This aquatic plant contains high protein potentialities for use as fishmeal and animal feed. A study was made to keep the duckweed cover alive round the year in an experimental pond fed with municipal waste water. Profused algal infestation took over the duckweed population causing the eventual disappearance of the later. Renewal technique using fresh inoculum to maintain the duckweed cover in the pond was tried but the trend of decay/dieout revealed that the growing of this plant was seasonal. In summer its response was noticed to be

photosensitive and also temperature dependent when the severe stress in the process of proliferation was noticed. Wind effect in drifting the duckweed with resultant thickened accumulated mat was found to aggravate the situation. When the decay of duckweed in nutrient enriched waste water was prevalent, the ring well adjacent to the pond showed to contain duckweed mat full in the water surface. This contrast indicated the condition of the growing medium of the duckweed. Duckweed inoculum was also introduced in fresh water pond but its survival round the year could not be maintained. Thus for the survival of the duckweed round the year, a guideline of the water quality as well as environmental condition needs to be made. Literature review suggests different parameters which appear mostly on laboratory scale or based on small scale pilot study. For large scale commercial use of duckweed in the area of low cost waste water treatment as well as for the production of alternative low cost fish meal round the year further research is necessary.

Upflow Anaerobic Sludge Blanket (UASB) Reactor for Sewage Treatment in Large Housing Project

J. N. Shome

Member, Institution Of Public Health Engineers, India

S. K. Neogi

Member, Institution Of Public Health Engineers, India

A Baishya

Assistant Engineer, Titagarh Municipality

Abstract

With the increase in population, the need for housing and shortage of available land is posing problem to the society day by day. Thus in planning housing colonies the concept of vertical development of housing to accommodate higher-population-density has become a growing demand of the time. Large septic tank is found difficult both in operation and maintenance. Provision of soak well or dispersion trench to handle the effluent from septic tank ultimately becomes environmental constraint in the locality. Small bore sewer tailored with effluent treatment system may be considered as an alternative. Upflow Anaerobic Sludge Blanket (UASB) treatment in treating sewage

of large housing colony is also another technical option. Under the guidance and consultancy of the Institution of Public Health Engineers, India, West Bengal Housing Board has constructed one UASB based sewage treatment plant at Rajapur Housing Estate to serve the designed population of nearly 7600. The BOD removal efficiency of the UASB based wastewater treatment plant working at Mirzapur, UP, is reported 70-75% on average. To meet effluent quality standard, the use of oxidation pond has been resorted to. To minimize the land area "Upflow packed bed filter" technique has been adopted at Rajapur Housing as an alternative to oxidation pond.

Impact of the Ganga Action Plan Phase 1 on the water quality of the river Ganga at Varanasi

R. R. Narayanan

Department of Chemical Engineering, Institute of Technology,
Banaras Hindu University, Varanasi - 221 005.

Kamal Tewari

Department of Chemical Engineering, Institute of Technology,
Banaras Hindu University, Varanasi - 221 005.

P. K. Mishra

Department of Chemical Engineering, Institute of Technology,
Banaras Hindu University, Varanasi - 221 005.

B. N. Rai

Department of Chemical Engineering, Institute of Technology,
Banaras Hindu University, Varanasi - 221 005.

Abstract

The river Ganga is the focal point for hundreds of millions of Indians irrespective of faiths, caste, creed, gender, wealth, property and age. With growing population and industries, the environmental problems of the Ganga have also increased. The river water in the holy city of Varanasi is highly polluted. 80% of the pollution is due to point sources (like sewage, open drain etc.) and the remaining 20% is due to non point sources (the users of Ganga viz. human beings).

This high extent of pollution gave rise to high B.O.D. and alarming levels of disease causing bacteria in the river water. Keeping this in mind, the Ganga Action Plan Phase-1 (GAP-1) was launched in 1986 to clean the

Ganga at five cities along its course so as to improve the water quality to acceptable standards. It concluded in 1993. It is extremely sad to note that the GAP-1 for Varanasi had failed because it was not conceived, designed and implemented properly. Around 48 crore rupees had been spent at Varanasi for constructing three sewage treatment plants (STP), sewer lines, electric crematorium etc. The STP's have failed in Varanasi as they do not control faecal coliform and have created problems of sludge disposal, leading to all kinds of water borne diseases. This paper reviews the water quality of Ganga at Varanasi before and after GAP-Phase 1, provides reasons for the failure of GAP-Phase 1 and offers useful suggestions for the GAP-Phase 2.

Water and Sewage Treatment Facilities in Varanasi : Present Status and Scope for Improvement

R. R. Narayanan

Department of Chemical Engineering & Technology
Institute of Technology, Banaras Hindu University
Varanasi - 221 005

K. B. Tewari

Department of Chemical Engineering & Technology
Institute of Technology, Banaras Hindu University
Varanasi - 221 005

B. N. Rai

Department of Chemical Engineering & Technology
Institute of Technology, Banaras Hindu University
Varanasi - 221 005

P. K. Mishra

Department of Chemical Engineering & Technology
Institute of Technology, Banaras Hindu University
Varanasi - 221 005

A. K. Jadey

Department of Chemical Engineering & Technology
Institute of Technology, Banaras Hindu University
Varanasi - 221 005

Abstract

The treatment facilities and the associated infrastructure development to handle the waste water may have several limitations on the environmental and socio-cultural fronts besides the associated economic constraints. As a consequence, most of the fresh water water bodies including major rivers are under severe threat of loosing their utility as fresh water sources fit for bathing and drinking River Ganga is such a typical case. This paper highlights these aspects and reviews the broad guidelines for selecting suitable water and sewage treatment facilities with special reference to the holy city of Varanasi. This paper also contains information on present status of all the major sewage treatment plant viz. Bhagwanpur, Konia and Dinapur, treated sludge characteristics and scope for upgradation of water and sewage treatment facilities in Varanasi.

Introduction

The river Ganga is one of the greatest in the world. It is the focal point where people's faiths, regional practices, caste, creed and gender merge together. The blend of this faith and culture can be seen at Varanasi with the Ganga flowing through. Today, the existence of these people is facing serious problems with problems of extinction too. The river water has become highly polluted and at some places it has become septic, with practically no dissolved oxygen and BOD more than 25 mg/L.

The pollution of Ganga is due to the presence of point sources of pollution as well as the non point sources. The point sources include open sewers, open drains and nallas discharging sewage into the river, whereas the non point sources include human beings using soap, detergent, throwing plastic bags into the river, washing of clothes etc. Point source and non point sources contribute 80% and 20% of pollution respectively.

As there is a large number of pollutant, it is difficult to measure and quantify the pollution accurately. In spite of this, pollution control plans are drawn and these plans should vary from place to place based upon the technologies that have proved to be successful elsewhere.

Present Status

In the nineteenth century, Varanasi had less than 50% of its present area. There were no flush toilets and only storm water flowed into the Ganga during 75 days of the year through open channels that were five in number. These channels met in between the two small river Varuna and Assi, which also used to take storm water. In the year 1719, public toilet was built for pilgrims. The attempt to build a drainage on scientific lines was taken during 1860 at Dashashwamedh Ghat. The Benaras Municipal Board was found in 1866. The beginning of pollution is linked to the nature of flush toilets and sewage systems.

It has been found that about 6 km upstream of Varasasi, the river is clean with BOD less than 1 mg/L and the fecal coliform less than 100 mph/100 ml. But in between the city limits, the river water deteriorates progressively. At the Assi Ghat, the BOD is 4 mg/L and fecal coliform is in the range of 50000-70000 mph/100 ml. At Varuna confluence, near Adikeshav Ghat, the fecal coliform level is around 1.5 million mph/100 ml. The colour of the Ganges is also brown and the river water becomes septic with methane bubbles emanating. One can now imagine the effect these will have on the health of thousands of people taking bath on the banks of the Ganges everyday.

Ganga Actrion Plan Phase-1 (GAP-1) was launched in 1986 and it was stated to clean the river so as to improve its quality and bring it to an acceptable standard. It was concluded in March 1993. GAP-1 was declared to be successful. But it was not so. Sewage flows practically unchecked into Ganga in the religious bathing area from about 30 point sources. The sewage treatment plants (STPs) made in Varanasi do not control fecal coliform. They have created a large problem of sludge disposal. Their operation and maintenance costs over Rs. 3 crores per year. They are also dependent on electricity. On top of these, the treated effluents from STPs cause immense problem of ground water contamination, water logging of agricultural field, water borne diseases to people who use the treated effluent 7 km of ghats. GAP-1 for Varanasi has failed because it was not appropriate for the place and was neither conceived nor designed properly.

Technology Available

The selection of the most appropriate technology will require an evaluation of not only the technologies themselves but also the physical, technical, organizational and financial resources that are present. The dilution or the cleaning capacity of the water body and the extent to which it is utilized by the community are also factors that should govern the selection of technologies. If land is available, either out of the flood plain or in the flood protractible location, the option should be to go in for a land intensive/low operating cost technologies such as oxidation pond and other variations of it. If the land is expensive and skilled labour is available, it is better to go in for a more compact system. Consideration of the open land, forested or unused land and the land size is a must. Large land areas and availability of open space of forest land, favours the use of individual on site or community serving land based treatment systems. The topography, soil texture and hydrological conditions also govern the

technology selections. Flat to mild slopes favour the use of land based system, moderate permeability with adequate separation to bed rock and seasonal high ground water favour the use of onsite or cluster soil absorption systems. Steep slope, occasional flooding and close proximity to unprotected drinking water wells favour the use of stream discharging mechanical system. The technical and organizational resources to be considered include availability of skilled man power, mechanical equipment support availability, access to laboratory and analytical skills, skilled plant operators and plant operator trainers or suitable plant operator trainees. These are absolutely crucial for the support of mechanical treatment systems. The availability of agricultural skills is supportive of certain land based system. The availability of spare parts, quick ordering and delivery system, trained repairmen familiar with the system are extremely essential. Access to well equipped testing laboratory is also essential for remaining in continuous monitoring mode. There must also be an access to a network of experienced plant operators and trouble shooters. The next duty is of the community at large which should ensure the availability of adequate financial resources to meet the initial construction costs through various means. Continuous cash flow by means of taxes are also needed to meet the financial requirements. Finally, coming to the technology, it must be capable of meeting the given effluent standards set by regulatory agencies and should meet the balance in load. The technology must also be simple and economically viable.

Based on the above discussions. Ganga Action Plan Phase - II (GAP) Phase - II) scheme can be designed and implemented. The delay caused in the implementation of GAP-II have caused great distress to the people of Varanasi. The need is to have an open technical examination of the proposal submitted for GAP-II for Varanasi for removing the point sources of pollution. This would mean the removal of 80% of the problem of Ganga pollution at Varanasi. The remaining 20% of the problem can be solved by educating the people on the alarming problems of water pollution.

The six sewage pumps installed at the ghats of Varanasi and the main treatment sewage pump at Konia installed at the end of the sewer network of Varanasi work on electrical power. Even with the installation of standby electrical generators, the pumps fail and sewage discharges into the Ganga at the ghats practically everyday. There is an inherent fault in the design of the interception and diversion system. For about five months per year, flood water enters the sump well of the pumps and the system has to be officially shut down allowing total sewage to flow into the Ganga.

The capacity of the Dinapur STP is 80 mld and is not sufficient for even the present needs. The amount of the bio-gas produced is unable to run the dual fuel generators and produce the desired electrical energy. The treated sewage coming out is dark blackish in colour and with BOD upto 120 mg/L. TSS upto 150 mg/L, fecal coliform 1.5 million per 100 ml. This is incomparable to the acceptable standards. This poor quality effluent is continuously percolating into the ground water aquifer and is raising the water level upto a few feet below the ground level in the areas adjacent to the effluent channel. The village pumps also give out blackish water having foul odour. This exposes them to a severe amount of water borne diseases.

The technology to be adopted for Varanasi should be suitable for India's tropical climate and environment and should have least dependence on electricity. The other things to be taken care of are operating and maintenance costs, high cost of land and scarcity of the same, pathogen removal, scarcity of skilled operators and mechanical spares and the rapid unplanned urbanization along the river. New system like Advanced Integrated Wastewater Oxidation Pond System (AIWPS) can be made use of and implemented effectively. The government must take steps to ensure these while implementing GAP-Phase II along with the effective participation of the people so as to solve their problem at the earliest.

References

1. Agarwal A.K., Hammad S.M., Status Report of GAP at Varanasi : Presented at Seminar on Pollution Control in River Cities in India - A Case Study of Ganga at Varanasi, Jan 14-17, 1992, Sankat Mochan Foundation, Varanasi.
2. Agarwal D.K., Gaur B.D., Sen P.C., Marwal S.M., Bacteriological Study of Ganga at Varanasi, Indian Journal of Medical Research, Vol. 64, No. 3, p 373 - 383, 1976.
3. Basin Sub Basin Inventory of Water Pollution - The Ganga Basin, Pt II ; Central Board for Prevention and Control of water Pollution; New Delhi - 1984.
4. Ganga Action Plan at Varanasi, Impact of GAP Schemes : Report, Varanasi - May 1992.
5. Ganga Action Plan - Highlights; Govt. of India, Ministry of Environment and Forests, New Delhi Report, 03/91 - a,p-15.
6. Gundevia D.S., A Brief Note on Varanasi Water Supply; Presented at Seminar on Pollution Control in River Cities of India - A case study of Ganga at Varanasi; Jan 14-17, 1992, Sankat Mochan Foundation, Varanasi.
7. Mishra V.B., Mishra S.K., Upadhyay S.N., Theme Paper Presented at Seminar on Pollution Control in River Cities of India - A case study of Ganga at Varanasi; Jan 14-17, 1992, Sankat Mochan Foundation, Varanasi
8. NEERI - Annual Report 1991, p-47, NEERI, Nagpur.
9. NEERI - Annual Report 1992, p-27, NEERI, Nagpur.
10. Pandey N.C., Sacred Ganga - Holy Dips, Annual Magazine of U.P. Jal Nigam A.E. Association, Dec. 1985.
11. Pandey N.C., Pollution Survey and Water Quality of River Ganga at Varanasi, M.E. Thesis, MLNREC, Allahabad, 1987.
12. Swatcha Ganga Research Laboratory - Ganga Water Quality Report; July 1993; Sankat Mochan Foundation, Varanasi.
13. Water Resources of Uttar Pradesh: Report, Irrigation Deptt., U.P.; April 1988.
14. Water Quality Studies - Ganga System, Status Report (1986 - 1991), Central Water Commission, G.O.I., New Delhi, April, 1992.
15. Linsedt K.D., Houck C.P. and O'Connor J.T., Trace Element Removal in Advanced Waste Water Treatment Process, J-WPCF 3:1507, July 1971.
16. Zuckerman M.M. and Molof A.H., High quality reuse water by chemical-physical waste water treatment, J-WPCF 42(3):437, March 1970
17. Environmental Engineers' Handbook Volume 1 Water pollution - Bela G. Liptak, 1974.
18. "Sludge Quality Monitoring from Three Sewage Treatment Plants at Varanasi for Safe Disposal" - Joshi V.A., Vaidya M.V. and Nanoti M.V.; Presented at International Seminar on Combined Waste Water Treatment, 20-21 March 2000.
19. 'The Hindu Environment Survey' of 1999.

Riverbank Filtration for Improved Quality : An Option During Plant Expansion

Chittaranjan Ray

Assistant Professor, Department of Civil Engineering,
University of Hawaii at Manoa, 2540 Dole Street,
Honolulu, HI 96822, Phone : (808) 956-9652,
Fax : (808) 056-5014, e-mail : cray@hawaii.edu

Abstract

Numerous water utilities in India and around the world rely upon surface water sources such as rivers for source water needs. The water quality in rivers varies widely and is often correlated with the river stage. For example, the concentrations of suspended solids, dissolved organic carbon, microbial pathogens, and microscopic particle matter can be quite high during flood stages. In western countries, rivers that receive water drained from agricultural watersheds are found to contain large quantities of pesticides and nitrogen fertilizers during peak flow periods. Riverbank filtration has been considered an acceptable alternative to other methods for surface water treatment. Riverbank filtration units are common in Europe and are being developed at a rapid pace in the United States. In Europe, communities located on lakes (many in Finland) opt for bank filtration as opposed to direct treatment of lake water. Riverbank filtration, which has some similarity with slow sand filtration, has been shown to be effective in removing suspended particles, pathogens, and dissolved organic chemicals. Levels of regulated drinking water parameters for communities using bank filtration rarely exceed the maximum allowable contaminant levels (especially the trihalomethane limits), as opposed to those for communities using surface water. We propose bank filtration as an option to consider during expansion of plants utilizing surface water sources. Results of studies in the United States and Europe are presented. Design features of horizontal and vertical bank filtration wells are also presented.

Introduction

Many riverbank communities obtain their water supply from alluvial or partially confined aquifers along riverbanks using vertical and horizontal collector wells. The quantity of water pumped and the distance of the wells from riverbanks control the amount of surface water that can reach these wells. Many riverbank communities have observed the effectiveness of the porous riverbed and the surrounding "bank" material in removing suspended and some dissolved chemicals from the river water before it reaches the pumping wells. This filtering process is commonly referred to as *riverbank filtration (RBF)*. The mechanism of bank filtration has similarity with slow sand filtration (SSF). In RBF the porous riverbed and underlying aquifer remove the contaminants from surface water as the water moves toward the pumping well(s). The contaminant removal process is attributed to physical filtering, sorption, and biodegradation. Dilution plays a key role in RBF (not feasible in SSF) when the concentrations of the respective contaminants in ground water are lower than that in surface water. Both vertical and horizontal collector wells have been used for RBF (Figure 1); typically, however, horizontal wells have higher production capacity than vertical wells. The laterals of horizontal wells, in most instances, are directed toward the river. Table 1 provides a list of selected bank filtration wells in the United States and Europe, including their pumping capacities and the river

system on which they are located. Although more horizontal wells than vertical wells are listed, in reality, a vast majority of small and medium-size communities in the United States use vertical wells.

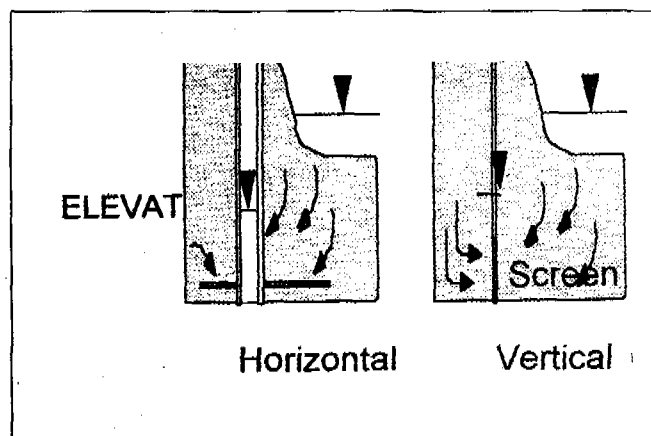

Fig. 1 : Schematic of horizontal and vertical bank filtration wells.

Bank Filtration Related Water Quality

The rise in the number of bank filtration facilities around the world has been attributed to the successful removal of dissolved organic matter, pesticides, nitrate, and microorganisms. Water turbidity is an indicator of microbial pathogen presence, hence turbidity

Table 1— Selected bank filtration facilities for public water supply in the United States and Europe

Site location	Well type	Number of wells	Peak pumping capacity (10 ⁶ L/day)	River system
	Horizontal(H) Vertical (V)			
United States				
Cincinnati, OH	V	10	151	Great Miami
Columbus, OH	H	4	151	Scioto/Big Walnut
Galesburg, IL	H	1	38	Mississippi
Independence, MO	H*	1	58	Missouri
Jacksonville, IL	H	1	30	Illinois
Kalama, WA	H	1	10	Kalama
Kansas City, KS	H	1	151	Missouri
Kennewick, WA	H	1	11	Columbia
Lincoln, NE	H&V	2(H)+44(V)	132(H)	Platte
Mt. Carmel, IL	V	1	4	Wabash
Sacramento, CA	H	1	38	Sacramento
Terre Haute, In	H	1	45	Wabash
Louisville, KY	H	1	58	Ohio
Sonoma County	H&V	5(H)+7(V)	322	Russian
Europe				
Torgau, Germany	V	42	150	Elbe
Mocritz, Germany	V	74	109	Elbe

*Gravel-packed laterals.

removal is a major effort in water treatment. RBF wells in Kalama, Washington, experienced at least one-log removal of river water turbidity (Mikels, 1992) Whereas river water turbidity varied between 1 and 5 nephelometric tyrbidity units (NTUs), the turbidity of bank filtrate ranged from 0.3 to 0.4 NTU. The riverbed infiltration for this system was estimated at 0.022 m/ day, In contrast, a typical slow sand filtration rate is 2.8m/day.

As part of the Information Collection Rule, the U.S. Environmental Protection Agency requires five large RBF systems (Cedar Rapids, Iowa; Cincinnati, Ohio; Dayton, Ohio; Lincoln, Nebraska; and Sonoma Country, California) to monitor levels of *Cryptosporidium* and *Giardia* in river water and bank filtrate on a monthly basis. Whereas the river waters were positive for these protozoa on many occasions, none of the RBF well waters were positive. The effectiveness of RBF systems in removing viruses was also shown in Europe, where between 3 and 6 logs were removed (Havelaar et al., 1995; Schijven and Rietveld, 1997).

Natural organic matter (NOM), considered precursors to the formation of trihalomethanes (THMs) and haloacetic acids (HAAs) during chlorination, is significantly removed through RBF. Miettinen et al. (1994) observed significant reduction in total and nonpurgeable organic carbons (likely source is NOM) and chemical oxygen demand during bank filtration of

lake water in Finland. Wang et al. (1995) observed at least a 60% reduction in total organic carbon of river water at a bank filtration site within a distance of 9 m from the river-aquifer interface. THMs and HAAs formed during chlorination of the filtrate were less than 50% of that expected during chlorination of settled river water.

Wilderer et al. (1985) studied the removal of synthetic organic compounds through RBF in the lower Rhine basin in Germany. The degree of removal of these compounds was found to be dependent upon their biodegradability as well as their initial concentrations. Wang et al. (1995) monitored Ohio River water and bank filtrate for the presence of atrazine (a pesticide used in agriculture). Whereas the concentration in river water exceeded 1 µg/L, the concentration in RBF well water was below the detection limit of 0.1 µg/L. Ray et al. (1998) monitored the concentration of atrazine in the Illinois River and at an RBF site in Illinois. During a peak flow event in 1996, the maximum concentration of altrazine in river water was 11.2 µg/L and that in the filtrate was 1.1 µg/L. This indicates nearly 90% removal efficiency.

RBF as a Viable Option During Plant Expansion

Many major cities in India use surface water from impounded reservoirs for the public supply. Chlorination is the main mode of water disinfection in Indian cities. Concentrations of NOM, pathogenic organisms, and

other microscopic particulates, as well as turbidity levels, are expected to be high in the source water during the monsoon season. It is expected that the water undergo similar quality fluctuations as those observed in many western countries. Capital investment for water treatment facilities to enhance the treatment efficiency for contaminants is often difficult due to unavailability of funds and the state's control over the drinking water industry. However, because many cities are experiencing rapid population growth, there is increased pressure to expand the capacity of the water treatment plants. Considering the benefits of the RBF process over the use of surface water, one may consider RBF as a viable alternative to direct use of surface water.

The use of RBF systems would require the installation of a series of vertical or horizontal filter (or collector) wells. Whereas the technology for vertical well drilling is well developed in India, the technology for drilling horizontal collector wells is not. Further, the market may not be able to bear the cost. Horizontal wells have their own merits as well as limitations over vertical wells. For example, the number of pumps and the operation and maintenance costs are low for horizontal wells, but the construction cost is higher. Further, for shallow horizontal wells, the removal of contaminants from river water may be low. Thus, with the current stage of technology, we recommend the use of vertical wells.

Vertical wells could be placed at appropriate distances from the riverbank in alluvial or semiconfined aquifers. Such hydrogeologic settings are not uncommon in India. Maintaining an appropriate distance from the river would provide a balance between the extraction of surface water from the river

or surface-water body and ground water from the adjoining aquifer. The minimum distance would depend upon geohydrologic conditions, pollutant load in the river, and pumping rates. Once the oxygen-and carbon-rich water enters the aquifer, due to induced infiltration, natural bacteria would use the introduced oxygen to breakdown the organic carbon in the infiltrating water and in the ground water. After the oxygen is consumed, the bacteria would use nitrate as the energy source for metabolic activity. In the process, high-nitrate water would be denitrified. If the travel distance is too long, all nitrate would be consumed and the concentration of reduced iron and manganese would increase. The optimal locations for the wells would be at sites where nitrate is 75% to 90% of that present in surface water. The condition would prevent excessive formation of iron and manganese. Depending upon the turbidity level, the filtrate in some sites may only require chlorination.

Summary and Conclusions

RBF can be a viable option for drinking water production in many Indian cities. RBF systems have been shown to be effective in removing pathogens (virus, bacteria, and protozoa), particulates, NOM, and synthetic chemicals. During plant expansion, Indian cities should consider installing RBF wells if appropriate geologic settings are available. At present, vertical RBF wells are more cost-effective for Indian conditions, and their placement can be optimized to remove dissolved organics and nitrate from surface water. Indian cities and states should invest more to study the feasibility of RBF as an alternative treatment technology during plant expansion or during the installation of new systems.

References

- HAVELAAR, A.H.; VAN OLPHEN, M.; & SCHIJVEN, J.F. Removal and Inactivation of Viruses by Drinking Water Treatment Processes Under Full-Scale Conditions. *Water Sci. Tech.*, 31:5-6:55 (1995).
- SCHIJVEN, J.F. & Rietveld, L.C. How Do Field Observation Compare With Models of Microbial Removal? *Under the Microscope-Examining Microbes in Groundwater, Proc. Groundwater Foundation 12th Ann. Symp. American Water Works Research Foundation and American Water Works Association* (1997).
- MIETTINEN, I.T.; MARTIKAINEN, P. J.; & VARTIAINEN, T. Humus Transformation at the Bank Filtration Water Plant *Water Sci. Tech.*, 30:10:179-187 (1994).
- Mikels, M. S. Characterizing the Influence of Surface Water on Water Produced by Collector Wells. *Jour. AWWA*, 84:9:77-84 (Sept 1992).
- RAY, C; SOONG, T. W.; BORAH D. K.; & ROADCAP, G.S. Agricultural Chemicals: Impacts on Riparian Wells During Floods. *Jour. AWWA*, 90:7:90-100 (1998).
- WANG, J. SMITH, J.; & DOOLEY, L. Evaluation of Riverbank Infiltration as a Process for Removing Particles and DBP Precursors, 1995 Water Quality Technology Conference Proceedings, American Water Works Association, Denver (1995).
- WILDERER, P.A.; FOERSTNER, U. L & KUNTSCHIK, O.R. The Role of Riverbank Filtration Along the Rhine River for Municipal and Industrial Water Supply. *Artificial Recharge of Groundwater*, Butterworth Publishers, Boston (1985).

Water Conservation Scheme by Proper Treatment and Recycling in Indian Steel Plants

Dr. Ranajit Chowdhury

Sr. Manager EMD, SAIL

Introduction

SAIL plants were consuming water at higher level than the norms presented by MOEF. The present approach of the SAIL plants is to minimise water consumption by recycling introducing technological expertise, thus drawing lesser discharge also to the river after effluent treatment. The scheme thus reduces considerably pollution load in the river to avoid detrimental effect on flora and fauna.

One possibility is to recycle the water from out falls. The scheme will require installation of collection pond, treatment units and pump houses and provision for distribution of pipe lines upto various units of the plant. But the disadvantages are that it will require huge capital cost and energy and it would not solve the pollution problem, because the waste water will continue to flow as a treatment water i.e. the effluent discharge into the river will be polluted.

The approach is to minimise water consumption and discharge and to maximise the recycle and reuse of water level to be viable. This approach is to conserve water by reducing wastage at the source or at the point of usage. It will reduce primary consumption of water by more effective use (higher cycle of concentration) by reducing wastage and by using the better technology.

The advantage is that there is lower capital investment and energy cost, lower pollutant discharge to nullah or river for better technology. This process will also cultivate better work culture and discipline. In view of the obvious advantages, the second approach which calls for conservation of water by reducing wastage at source by the way of technology upgradation, local reuse and recycle of water has been recommended for implementation of water conservation.

The conservation measures to be taken are

- Once through system should be replaced by more and more close circuit recirculation systems.
- Dry dedusting is to be adopted instead of wet system.
- Make up water to be drawn from bleed off of B. F cooling instead of fresh settled water.

- Recovery of clarified water from ash ponds.
- Treated water from O.D plant can be used as make up water in coke quenching.
- Sludge from the clarifier is to be taken to sludge pond and overflow from the sludge pond to be recovered and sent to work reservoir.
- Proper and regular maintenance of pump houses and pipe lines should be practised.

It is tried to represent waterflow scheme in connection of water conservation before and after implementation of recommended scheme for DSP, RSP and BSP Flows are represented in m³/ annum.

The Common scheme for these Plants. DSP, ASP and BSP before implementation alongwith BSL, ASP, IISCO, VISL and MEL for their status condition are as follows :—

There is drawal of water from the nearest river and sending it to the reservoir. Then it is divided into two parts of flow. One part will go to the Plant which is again subdivided to existing plant and modernisation and other main stream will go to the township. The effluent from the Plant with modernisation unit and other main stream from the reservoir is directed to township. The effluent from the Plant with modernisation units after treatment go to respective outfalls. From the outfalls, the discharge is returned to the original river. The effluent from the township also meets the river after treatment. The general scheme of the Plant after implementation of the same will be as follows :

The water is drawn from the river and is sent to the reservoir. One stream is going to Plant with modernisation unit where the implementation schemes are already there for recycling, treatment plant and sludge filtration unit which will save a considerable quantity of water. From the outfalls, after treatment some portion of the water are recycled to the Plant. In this way also some amount of water is saved.

The other stream from the reservoir is going to the township and some amount of water from the discharge of the township is recycled to the Plant after effluent treatment. So net discharge, i.e. the net drawal of river, i.e. the net consumption in the Plant will be reduced to the extent of sum total effect.

Table : 1— Prescribed Norms and actual discharge & consumption rate

Symbol — C : Specific rate of consumption — m³/ tcs
D : Specific rate of discharge — m³/ tcs

MEF Norms of

Plants	Water discharge m ³ /tcs (D)						Water consumption m ³ /tcs (C)					
	< 16		< 18				< 16		< 18			
	D	S	P	R	S	P	BSL	IISCO	ASP	SSP	VISL	MEL
	C	D	C	D	C	D	C	C	C	C	C	C
Before implementation	21	—	38.5	23.8	8.9	3.5	22.5	17.6	5.3	24.38	20.2	16.1
After implementation			21.3	9.3								
Further implementation			12.56									

Table : 2 — Recommended Scheme & the expected benefit

D S P		B S P		
Recommended Scheme	Expected Benefit	Recommended Scheme		
(1) Outfall - 1recycling	400 m ³ /hr	(1) Installation of flow-metering and leakage detection facility.		
(2) Rolling Mill Compressor recycling	50 m ³ /hr	(2) Repair Replacement of old Pipeline		
(3) Skelp Mill recycling water	100 m ³ /hr	(3) Installation of Central Sludge filtration plant, SP-II.		
(4) Flow meter leakage detection facility	500 m ³ /hr	(4) Treatment facilities for recycling Pump House I & II		
(5) Slag Bank water recycling	25 m ³ /hr	(5) Recycling and treatment facilities for township effluents		
(6) CME - shop	28 m ³ /hr			
(7) Coke Oven & By Product effluent treatment and recycle for Coke quenching	90 m ³ /hr			
(8) Refurbishing of water supply system for B.F. Complex (Sludge handling) filtering etc.	250 m ³ /hr			
(9) For Power Plant				
(a) Bottom ash quenching	150 m ³ /hr			
(b) Chemical	250 m ³ /hr			
Total saving	1843 m ³ /hr			

Table : 3 — Recommended Scheme & the expected benefit

Recommended	R. S. P.	Expected benefit
(As per BHP-Kinhill Report)		
(1) BF Sludge dewatering facility		216 M ³ /hr
(2) Ash pond water recycling		500 M ³ /hr
(3) CRGO Emulsified Oil facility		270 M ³ /hr
(4) New BOD Plant		15 M ³ /hr
(5) SMS Cooling Water System		50 M ³ /hr
(6) Plant effluent		50 M ³ /hr
Total saving		1101 M ³ /hr
Additional Scheme		
(1) Treatment of back wash water		600 M ³ /hr
(2) Leakage survey and rectification of under ground Pipeline		1000 M ³ /hr
(3) Conservation of drinking water		200 M ³ /hr
Grand Total :		2901 M ³ /hr

In the table (1), the prescribed norms and actual discharge and consumption rates are depicted for different SAIL Plants. In the table (2) and (3) the recommended implementation scheme with expected benefits in terms of water saving in M³/hr for the Plants DSP, RSP & BSP are shown.

Reason for high consumption

a. Design Efficiency

Most of the SAIL plants are more than 25 years old. Availability of water at the time when these plants were started was more compared to this days. Though attention was given to effective utilisation of water, in many cases once through systems were adopted in place of close circuit recirculating system. This resulted in higher requirement of make up water from the source specially in the plants DSP, IISCO and RSP where a number of once through system have been provided.

Table : 4 — depicts flow consumption characteristics of Durgapur, Rourkela and Bhilai Steel Plants before and after implementation in M³/hr.

Let M = Modernisation

Description	D.S.P.		R.S.P.		B.S.P.	
	Before Imp- lementation	After Imp- lementation	Before Imp- lementation	After Imp- lementation	Before Imp- lementation	After Imple- mentation
(1) Once through system	1815 with M (1930) <u>Total - 3745</u>	1269	3671	1814	—	—
(2) Make Up to recirculation system	2739 with M (3586) <u>Total - 6325</u>	2686	4244	2562	—	—
(3) Total settled water required (Industrial water requirement)	4554 with M (5516) <u>Total - 10070</u>	3955	7915	4376	5293 (2.5 MT) & 6265 (4.0 MT) <u>Total - 11558</u>	
(4) Discharge through and outfalls	2087 with (2387) <u>Total - 4474</u>	1239	4899	1913	3581 (2.5 MT) 4022 (4.0 MT) <u>Total - 7603</u>	

Table : 5 — Represents Water Consumption Status of following SAIL Plants

1 M m³ = 10 m³

Plant	Make up water m ³ x 10 ⁶	Drinking Water		Water Horticulture etc. m ³ x 10 ⁶	Effluent discharge m ³ x10 ⁶	Crude Steel Production/ Ton
		Township m ³ x 10 ⁶	Plant m ³ x 10 ⁶			
BSL	141.1	(1) From river Garga 10.4			(1) O.F. - 1 : →17.5	3.78 x 10 ⁶
		(2) From Cooling Pond 56.2	15.7	—	(2) O.F. - 2 : 8.8	
		<u>Total 66.6</u>			(3) O.F. - 3 : → 2.6 <u>Total O.F. : 28.9</u>	
IISCO	12.2	6.9	2.2	—	(1) O.F. - 1 : →3.2 (2) O.F. - 2 : →1.0 <u>→Total O.F. : 4.2</u>	3.2 x 10 ⁶
ASP	4.6	—	1.8	—	—	0.2x10 ⁶
SSP	1.8	0.5	0.4	0.22	0.21	0.05 x 10 ⁶
VISL	1.5	5.3	0.7	—	(1) Under bridge → Outlet 1.1 (2) River Pumphouse → Outlet : 0.12 (3) Treated at STPS →at Township : 1.5	0.08x10 ⁶
MEL	1	0.05	—	—	—	0.06x10 ⁶

Plant	Total make up water to plant Mm ³ /Yr	Production of crude Steel Mt/Yr.	Specific consumption m ³ /t	Norm m ³ /t
BSP	25.913	3.68	7.04	
DSP	61.75	0.67	92.16	
RSP	87.83	1.25	67	4-5
BSL	105.43	3.65	28.88	(Developed countries)
IISCO	16.33	0.36	45.36	

Plant Township	Water consumed Mm ³ /Yr	Present Population Nos (approx.)	Per capita Consumption Lit/day/head	ISI norms Lit/day/head
BSP	56.28	3,50,000	440	
DSP	24.87	2,50,000	272	
RSP	19.50	2,00,000	268	270
BSL	57.21	3,60,000	435	
IISCO	9.20	1,25,000	201	

Ideally the plants should be designed with zero discharge concept. This involves isolating the water used in the plant under 2 categories (1) Cooling water and (2) Process water. Cooling water does not get contaminated and needs only to be cooled for reuse. Contaminated water should be given proper treatment and then released. This concept of zero discharge achieves 2 major objectives.

- Water conservation by ensuring minimum intake of water.
- Water pollution control.

Captive Power Plants

In most SAIL Plants captive power plants have been installed subsequently to help meeting the power requirement of the plants. In these plants wet disposal of ash has been adopted without any arrangement for recovery of the water used for conveyance of the ash in slurry form to ash ponds. This has considerably increased the make-up water requirement in SAIL plants.

Inadequate Secondary Usage

Outfits from effluent treatment like BOP Plant at coke ovens to treat phenolic waste water, acid neutralisation plants of cold rolling mills, sewage treatment plants etc are generally discharged out of the plants. Instead, provisions could have been made for their recycling/reuse in such process areas.

Inadequate Maintenance

Inadequate maintenance of water supply system appears to be major reasons for current high rate of water consumption in SAIL plants. This is evidenced

by the following observations in SAIL plants. Leakage from underground water mains constitute major portion of water wastages, in some plants like BSP and DSP. Sometimes choking of return water lines causes considerable amount of water losses. In many areas of SAIL Plants i.e. B.F. and SMS Gas cleaning plants, dust extraction plants of sint plants, lime plant, sewage treatment plants etc. elaborate water clarification plants have been provided, so that the solid contents of the contaminated water could be removed and clear water can be reused. The effectiveness of the systems mainly requires frequent removal of sludge at the bottom of the water clarifiers. If the sludge is not removed as required, it gets built up in the clarifiers reducing effectiveness. The overflow water from the clarifiers no longer remains adequately clean which then starts choking the nozzles and pipelines. To overcome this problem, bleed off from the system is increased and more fresh make up water is added to keep the suspended solids contents in the circulating water within control. Many a times return water line designed to carry out water to the reservoir for cooling, gets choked due to lack of regular cleaning causing water to overflow from the system to drains and thus is lost.

In Township

High consumption rates in township are generally caused by leakages in underground pipelines, missing and leaking taps, inequitable distribution, unauthorised tappings.

In this context it is worthy to mention that there is no flow in the outfall 4 of DSP. Total recycling of water is being practised in BSP and IISCO in the coke quenching operation.

Conclusion

Uncounted loss like seepage loss, loss of water due to evaporation and leakage in pipelines, joints and other accessories can be avoided by proper checking and immediate remedial measure.

DSP has reported a figure of 6854 m³/hr in the statistical data for the year 1992-93. The difference of 23000 m³/hr is found out to be the leakage from NB

900 water main. The leakage has been repaired during 20-25 January, 1995.

Huge energy consumption and cost in a Steel Plant can be minimised by reducing water consumption to the minimum level and recycling the same in maximum amount after proper treatment thus maintaining the level of water qualitatively and quantitatively.

Concept of Rejuvenation and Conservation of Hussain Sagar Lake, Hyderabad — A Case Study

K. C. Waghray

General Manager(E), World Bank Constr. Divn. No. 1
H.M.W.S.& S. Board, S. R. Nagar, Hyderabad

B. Mukesh

Manager (E), World Bank Constr. Divn. No. 1
H.M.W.S.& S. Board, S. R. Nagar, Hyderabad

P. Rajendar

Manager (E), (CDC), World Bank Constr. Divn. No. 1
H.M.W.S.& S. Board, S. R. Nagar, Hyderabad

Introduction

The water is vital for human, animal and plant lives or for that matter any living organisms. Hence most of the civilizations in the world have developed along the water bodies like rivers, lakes, ponds etc. In olden days the population was less, further mortality was less and the waste generated by human and other uses was assimilated by receiving water bodies. As the time progressed the quantity of wastewater generated was increasing and assimilation capacity was decreasing and the water quality of water bodies started deteriorating due to increase in human activity. The deterioration of water quality of receiving water bodies was resulting in the imbalance of the eco-system and aquatic life and other microorganisms started to extinct. Further human beings who consumed this contaminated water were becoming sick due to water borne diseases.

The process of colonization, urbanization and industrialisation continued in the catchment areas of rivers, lakes and ponds resulting in the further deterioration of water quality of receiving water bodies unabated.

The developed countries however were quick to realize these problems and with a scientific approach the pollution of water bodies was arrested and most of the lakes and rivers were rejuvenated and conserved in an effective way. They have laid sewerage systems including sewage treatment plants and effluent treatment plants for industrial wastewater with strict treated effluent water quality control.

But in a developing country like India, the exploitation of water bodies is full continuing un-abated. Most of lakes are becoming biologically dead; rivers are carrying water contaminated with domestic and industrial wastewater leading to ground water pollution. Many types of pollutants like sewage, industrial wastewater and water contaminated with pesticides, fertilizers are being let into fresh water bodies.

Most of the drinking water sources are polluted

with contamination of water. One such classic example is the famous lake of Hussain Sagar lake situated in the heart of the twin cities of Hyderabad and Secunderabad.

Hussain Sagar Lake

The history of Hussain Sagar lake that lies as a natural division between the twin cities of Hyderabad and Secunderabad goes back more than 400 years into the past. It is built by Qutubshahi dynasty in 1562 A.D. The lake served as one of the drinking water sources upto 1930.

Due to industrialisation and urbanization of the catchment area of the lake and poor town planning, the blue water of the lake became dark, dead water body. The untreated domestic and industrial waste water entered the lake through storm water drains which used to feed the lake with rain water.

Sailent Features of lake

Volume of the lake	:	28.6 million cubic metres
Surface area of the lake	:	5.7 million Sq. Metres
Average depth	:	5 M
Variable depth	:	1 - 12 M
F.T.L.	:	513.43 M
M.W.L.	:	514.93 M
Tank bund level	:	518.16 M
Catchment area	:	240 Sq. Kms

The lake receives its inflows mainly from four nalas namely Kukatpally, Picket, Banjara and Balkapur. The average rainfall in normal year is about 75 CM and the natural inflows into the lake from the catchment area through the above said nalas is about 30 million cubic metres.

Apart from the above main water the nalas are also carrying dry weather flows which contains domestic and industrial waste water as shown in the table below :

Sl. No	Name of the Nala	Domestic Flow in MLD	Industrial Flow in MLD	Total Flow in MLD
1.	Kukatpally Nala	55	15	70
2.	Picket Nala	6	-	6
3.	Banjara Nala	6	-	6
4.	Balkapur Channel	13	-	13
Total		80 MLD	15 MLD	95MLD

Rejuvenation Strategy

In 1993, HMWSSB came up with a project known as "Abatement of pollution of Hussain Sagar lake". In planning the above project, studies were carried by the Board's Consultant M/s. AIC Watson, Mumbai.

The rejuvenation strategy consists of two phases:

- Phase-I : Long term tasks
- Phase-II : Short term tasks

Long Term Tasks (Phase-I)

The lake is polluted due to discharge of untreated domestic and industrial wastes. Hence master plans are prepared to construct the facility of sewerage system in the complete catchment area of the lake including sewage treatment plants such that no untreated waste water will enter the lake or any other receiving water body. Further to direct the industries to construct their own effluent treatment plants or common effluent treatment plants, so that no un-treated industrial waste water will enter any sewer, lake or any other receiving water body. This part is to be implemented by the Agency "AP Pollution Control Board".

The above master plans are targeted for the year 2011 and 2021. But the rejuvenation of lake can not be delayed for such a long period. Therefore, short term task is also planned simultaneously.



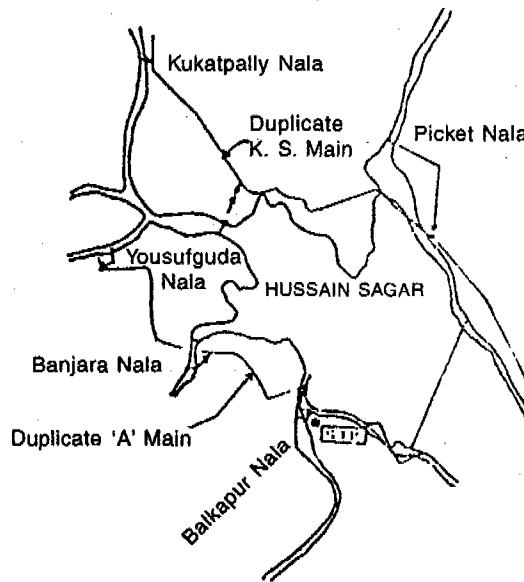

Diversion arrangements for nalas

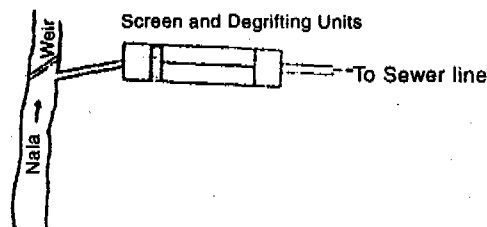

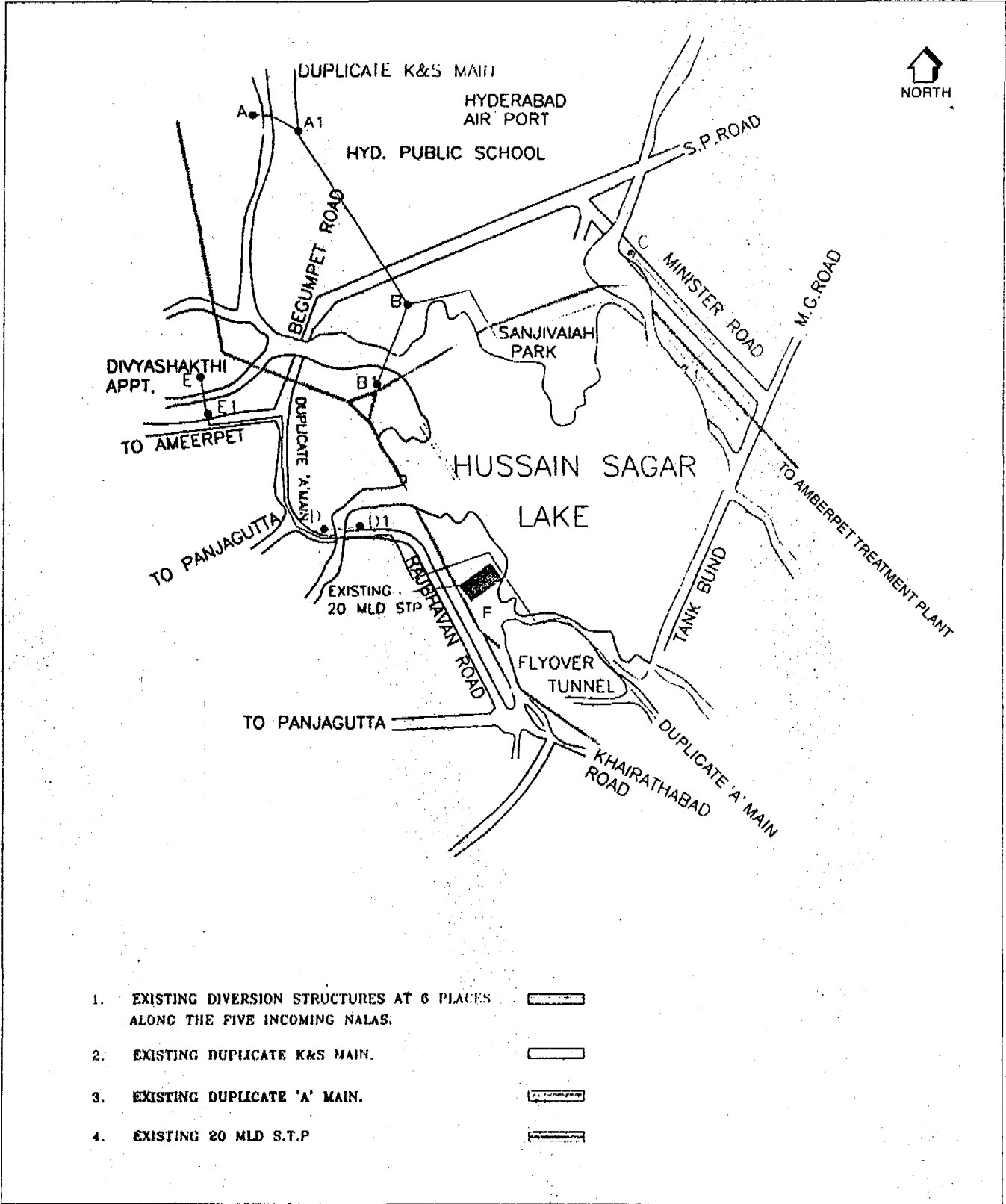
Typical diversion arrangement





1. EXISTING DIVERSION STRUCTURES AT 6 PLACES ALONG THE FIVE INCOMING NALAS. 
2. EXISTING DUPLICATE K&S MAIN. 
3. EXISTING DUPLICATE 'A' MAIN. 
4. EXISTING 20 MLD S.T.P 

Short Term Tasks (Phase-II)

The short term tasks consists of diverting all dry weather flows into sewers by constructing diversion works such that no waste water enters the lake except in rainy season.

In this particular case on the Northern Side of the lake a trunk sewer namely duplicate K&S main is laid and the Kukatpally Nala and Picket Nala can be diverted into this main by constructing diversion works. On the Southern Side of the lake a 1600 mm dia 1800 mm dia RCC sewer namely duplicate 'A' main is proposed. So that Yousufguda Nala, Banjara Nala and Balkapur Channel can be diverted as shown in the Plan.

Typical Diversion Arrangement

The sewage in open nalas consists of organic matter, floating matter, garbage, plastics, debris, grit etc. Before waste water is diverted into any sewer all floating matter, garbage, plastics, debris, grit etc, should be removed otherwise the pipeline may get choked. Hence to remove floating matter and debris two units are required namely screen chamber and dewatering chamber as shown in plan.

Further to divert a flowing nala an obstruction is to be created by constructing a weir with a skew of 60°, so that waste water flows into the diversion units. The top level of the weir should be so designed such that only dry weather flow enter the diversion unit and during rainy season excess storm water should over flow over the weir and join the lake. The weir should be provided with gates or sluice valves which can be opened in rainy season to scour the silt deposited on the up stream side of the weir.

In this particular case, six diversion units are constructed to divert dry weather flows into the two said trunk mains.

1. Diversion of Kukatpally Nala near Air Port into duplicate 'A' main
2. Diversion of Kukatpally nala near Prakash Nagar into duplicate 'K&S' main
3. Diversion of Picket Nala near Minister Road into duplicate 'K&S' main
4. Diversion of Yousufguda Nala near Divya Shakthi Apartments into duplicate 'A' main.
5. Diversion of Banjara Nala near Yashoda Hospital into duplicate 'A' main
6. Diversion of Balkapur Channel near Sewage Treatment Plant (STP) into duplicate 'A' main

For all the above nalas except Picket Nala it was possible to divert the DWF by gravity and the invert levels of the said two trunk mains are less than that of the bottom of the nalas near diversion points.

In the case of Picket Nala duplicate 'K&S' main is 1200 M away from the diversion unit and gravity line is not possible. Hence after diversion unit a pumps house is constructed and 3 Nos. of 50 HP submersible pumps are erected to pump the diverted waste water through a 400 mm dia DI rising main upto the duplicate 'K&S' main.

20 MLD Sewage Treatment Plant (STP)

All the diversion works are completed in 1997 and the diversion of dry weather flows commissioned. During dry weather no waste water is entering the lake through these nalas except in monsoon. Any water body requires inflows to maintain its hydrology and make up for the losses like percolation, evaporation and water drawls. If all the nalas are diverted the inflows during monsoon alone are not sufficient to maintain the lake water level and hydrology. Hence a 20 MLD Sewage Treatment Plant with extended aeration process is constructed and commissioned by reclaiming 2.5 Hectors of lake area. The diverted waste water is drawn into the STP from duplicate 'A' main and let into the lake after treatment so that the hydrology of the lake is maintained and the minimum level of +512.00 is maintained. The quality of the treated effluent entering the lake are maintained to satisfying the lake water quality disposal standards, such as BOD less than 20, SS less than 30 etc.

Inference

The 20 MLD Sewage Treatment Plant was commissioned on 28-5-1998 and is functioning excellently along with the diversion works. With in 2½ years of time the water quality of the lake has improved considerably. The dead aquatic life is regenerated in the eco-system, Millions of fish are seen due to increase in dissolved oxygen, and also many varieties of birds, ducks, and swans are seen nowadays. The dark water became greenish blue and devoid of any smell or nuisance. In short the past glory is limping back and the rejuvenation process has gained momentum.

The cost of the total project is about Rs. 25.00 crores. This concept of rejuvenating and to regain the lost glory of lakes in the heart of the twin cities has become an exemplary to the other states and cities in India and can be a pilot scheme and eye opener to the others.

Modern On-Site Water Quality Monitoring Instrumentation

G. B. Diwakar

Asst. Product Manger, Orbit Technologies Pvt. Ltd.
404/405, 4th Floor Golden Edifice, Khairatabad, Hyderabad-500 004

Abstract

Necessity of Water Quality monitoring : Water is one of the precious natural resources whose quality is deteriorating because of the pollution. Awareness in public is growing about water quality and its importance in keeping good health. Water testing has become mandatory before & after water is treated and also during the supply of the same to public. Similarly it is also very important to monitor the quality of the natural water bodies such as lakes, rivers etc.

What is the necessity of ON-SITE water quality monitoring

Most of the authorities are presently testing water in their laboratories. Many times water samples loose their characteristics by the time they are brought to laboratories. In case of public health authorities, on-site water testing becomes very important during the times of floods, periodic testing at some sites for immediate remedial actions, community education, and many such requirements.

Long term monitoring of natural water for any contamination with latest instruments, gives timely and precise information about the sources/causes o contamination.

Modern on-site water quality monitoring instrumentation

We have two types of monitoring instruments:

Type 1: Instruments, which need attended analysis & logging

Type 2. Instruments, which can be deployed for unattended monitoring of water bodies

Type 1 instruments are primarily chemical analysis instruments using various types of chemical analysis techniques such as colorimetry, titrimetry, electrochemistry and turbidimetric techniques.

The product range under this category can be a Portable Spectrophotometer or a Portable colorimeter or simple test kits. Field Titrator, Portable pH meters, Portable Conductivity meter and Portable Turbidity meter etc. All the instruments are field oriented and work on battery. Portable Spectrophotometers/ Colorimeters are preprogrammed and do not require any on-site calibrations. Pre-packed reagents make on-site analysis easy and convenient. The analysis methods supplied along with these instruments are simple to understand and easy to follow. With a simple analysis method, ready-made reagents and rugged and user-friendly instruments form an analysis system, which makes the on-site water quality analysis easy and effortless. Most of the water quality

parameters from Aluminium to Zinc can be analyzed with this kind of analysis systems and results can be obtained on-site.

These instruments are becoming very popular these days with departments who are testing urban & rural water supplies alike. Most of the companies now supply complete systems, which are called as test kits for one or two parameters or portable laboratories for more parameters. There are some portable laboratories, which are supplied with instruments, reagents and apparatus to test more than 30 water quaity parameters on-site. These labs can be carried in vehicles such as jeeps or custom-built mobile vans.

Type 2 instruments are primarily meant for unattended, continuous water quality monitoring. These are sophisticated instruments with built-in-multi-sensors, memory and Power supply in one compact unit. The unit can be deployed in a lake/river/ocean over a period of 30 days or more and can store the water quality at an interval of every 15 minutes in its internal memory. The stored data can be retrieved at any time by a data logging and display unit/PC/.notebook computer/MODEM or through any other Data Acquisition platforms. These monitoring systems can log simultaneously upto 16 water quality parameters like pH, ORP, Conductivity, Specific Conductance, Resistivity, Total Dissolved Solids, Dissolved Oxygen, Temperature, Salinity, Turbidity, Nitrate, Ammonia, Chloride, Vented level, non-vented level and Chlorophyll. Logged data can be used for data representation in graphical forms or in tabular form for reporting purpose using a powerful window based software.

Conclusion

With the above types of on-site water quality monitoring instrumentation, water testing is made simple and easy. The chemists and the public health engineers can now spend less time in carrying samples and they can now bring the analysis to the site for faster remedial actions.

WHO TESTS?

- Water Works Dept.
- Public Health Dept.
- Pollution Control Board
- Institutions /Universities/R&D Labs
- INDUSTRY
 - Power Industry
 - Chemical/Petrochemical
 - Refinery /Fertilizer
 - Pharmaceutical
 - Water Treatment Co.
 - Many more

HOW ARE WE TESTING PRESENTLY?

Primarily in Laboratories

NECESSITY FOR ON-SITE TESTING

Difficulties in retaining sample integrity
Immediate Corrective action
Long & Continuous monitoring

Types of an-site instruments for Water Quality Testing

- **Hand Held instruments • Chemical Analysis Insts.**
 - pH Meter Colorimeter
 - Conductivity Meter Spectrophotometer
 - D.O. Meter
 - ISE Meter
 - Turbidimeter
- **Portable Labs /Kits**
- **Deployable Multiparameter Instruments.**



Components of DREL/2010 Lab

- DR/2010 Portable Datalogging Spectrophotometer
- Portable pH Meter
- Portable Conductivity Meter
- Digital Titrator
- Portable Turbidimeter (optional)
- Reagents and apparatus needed for on-site testing 27
- Common water quality parameters

DR/2010 Portable Datalogging Spectrophotometer

- Portable (Battery as well as mains operated)
- Rugged and lightweight (approx. 2 kgs.) 120 Preprogrammed method for over 70 common water quality parameters
- Datalogging capability 1000 data points RS-232 serial output for PC/printer connectivity

Digital Titrator

- Uses Prepackaged reagents
- Dispenses very small amounts of Titrant approx. 6µl
- Light weight and rugged apparatus
- Replaces fragile burette and usage of large quantities of chemicals
- Provides a direct readout of sample concentration with its mechanical digits display
- Greater level of precision and accuracy
- Very convenient for on-site testing

Prepacked Reagents

- Convenient for use at on-site
- Pre-weighed. Eliminates requirement of analytical balance
- Pre-packaging assures no reagent contamination and thus greater accuracy.
- Minimize waste Saves time and man power requirement.

Parameters with DREL/2010 Lab

(Approx. 40 parameters can be tested on-site)

Acidity	Manganese, HR
Alkalinity	Nitrogen, Ammonia
Bromine	Nitrogen, Nitrate
Carbon Dioxide	Nitrogen, Nitrite
Chloride	pH
Chlorine F & T	Phosphorus, Reactive
Chromium	Phosphorus, Total
Conductivity	Residue, Non-filterable
Copper	Silica
Dissolved Oxygen	Sodium Chromate
Fluoride	Sulfate
Hardness	Sulfide
Iodine	Zinc
Iron Total	

DREL/2010 Portable Labs

Advantages:

- Rugged and convenient for on-site testing
- Fast set up
- Easy to operate
- System concept i.e., Step-by-step procedures, instruments and reagents ensure better accuracy.

Disadvantages:

- High cost because of high import duties
- Stocking of reagents

USERS LIST

- B.D.L
- B.H.E.L., Chennai
- B.H.E.L., Tiruchunapalli
- B.H.E.L. Ranipet
- C.S.M.R.S., New Delhi
- Diabhol Power Project, Ratnagiri
- Nestle
- N.H.P.C.
- N.T.P.C.
- MCD, New Delhi
- Panchayat Raj Department, Hyderabad
- Regional Research Laboratory, Bhopal
- SAIL all plants
- Many more

Sensors for 6-Series Sondes

- | | |
|--------------------|--------------------------|
| 600XLM* | 6600*, 6920 |
| • Temperature | • All Sensors of 600XLM |
| • Conductivity | • Nitrate |
| • Dissolved Oxygen | • Ammonium |
| • pH | • Chloride |
| • ORP* | • Chlorophyll |
| • Depth* | • Turbidity |
| • Level* | • Total Dissolved Gases* |

SONDE CONFIGURATIONS

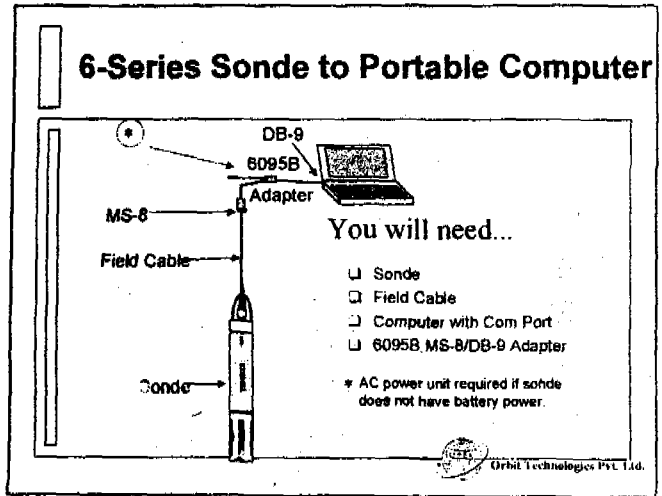
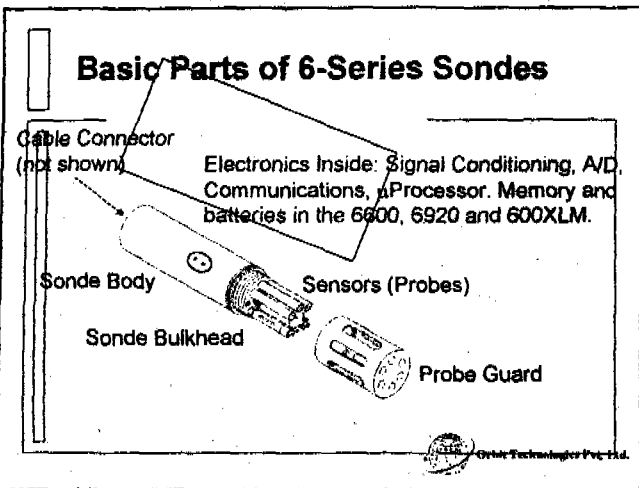
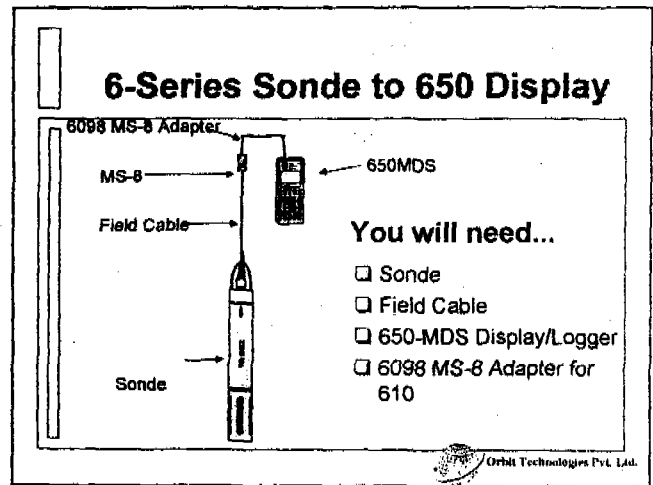
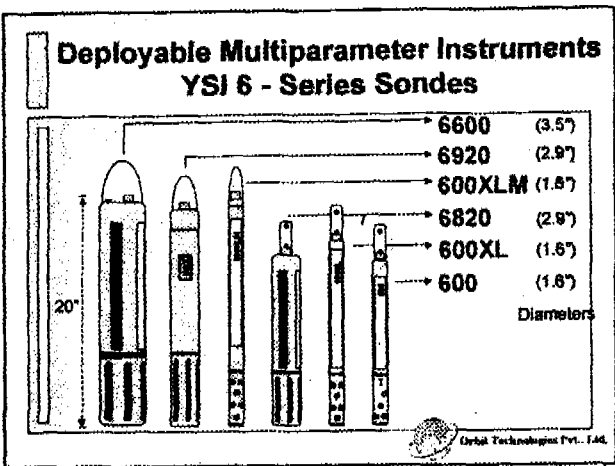

6-Series Sonde to MODEM Link

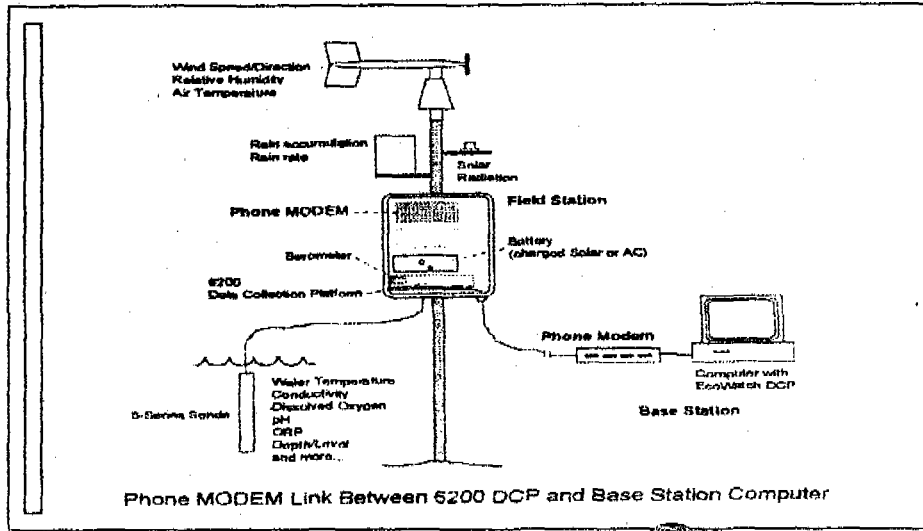

Orbit Technologies Pvt. Ltd.

6-Series Sonde to RADIO Link

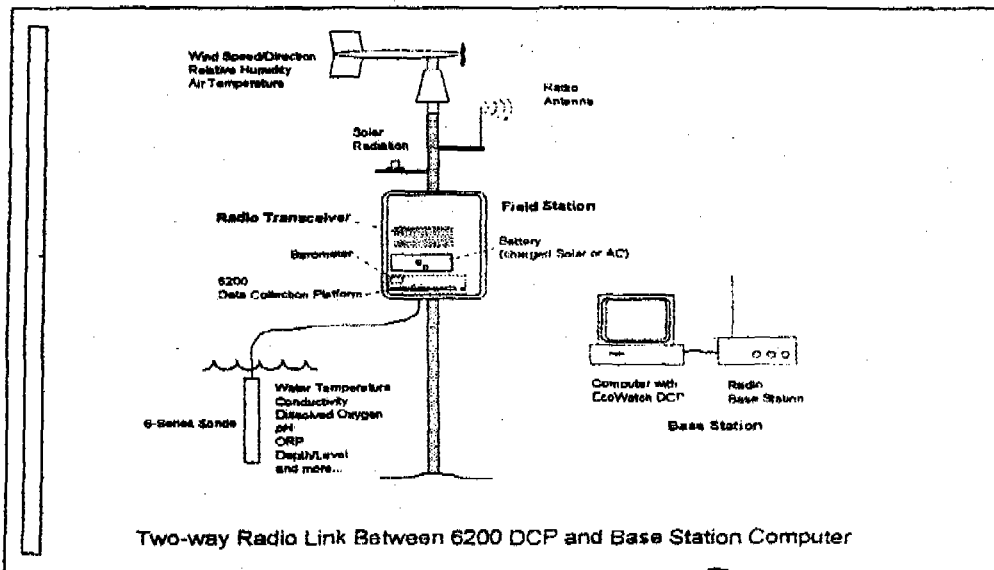

Orbit Technologies Pvt. Ltd.

Sampling vs Monitoring...

DO and Temperature

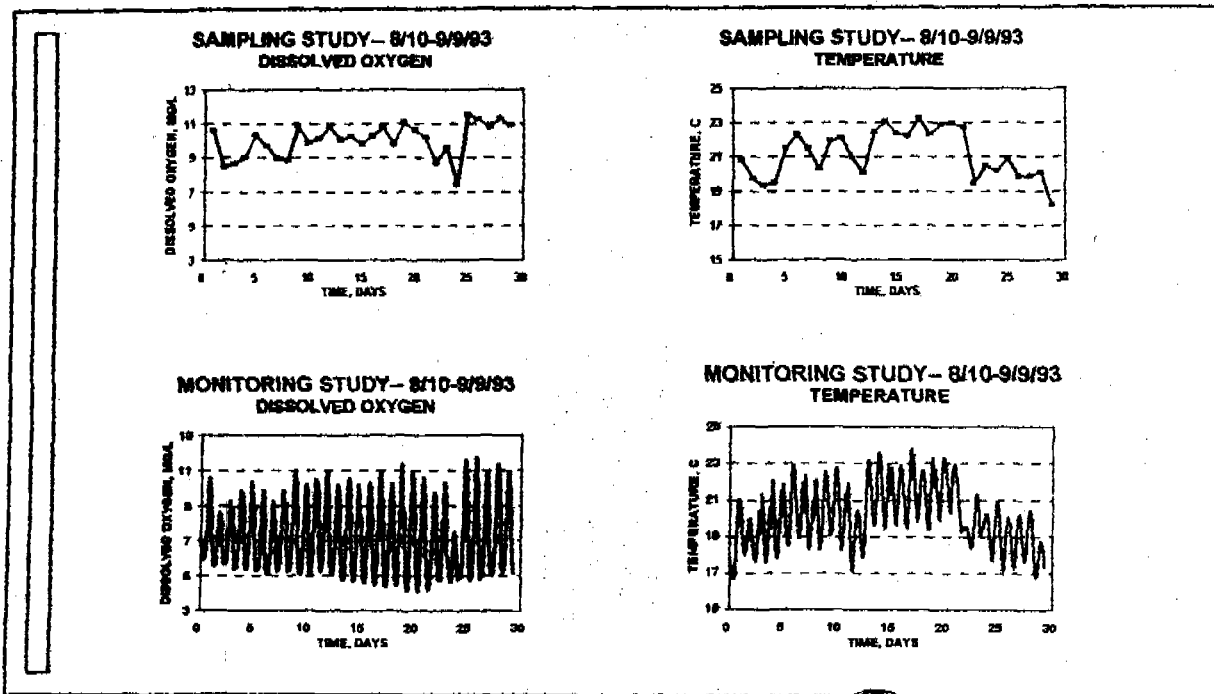

Orbit Technologies Pvt. Ltd.

Monitoring Vs Sampling

Monitoring Advantages...

- Data presents more complete picture
- Pollution events can be observed
- Better correlation of parameters
- Less effort overall

Monitoring Disadvantages...

- Cost
- Security
- Sensor Drift
 - General Drift
 - Fouling

Conclusion

Both Analysis and deployable instruments have their own advantages and disadvantages when compared to each other. An effective on-site water quality monitoring system can be selected based on specific user's requirement.

Safety in Chlorination Plant

Dilip Amrut Dongare

Deputy Engineer (Mech),
Maharashtra Jeevan Pradhikaran, Nashik

Abstract

The Chlorine is made available in containers under pressure. Although chlorine is not poisonous gas it affects respiratory system if inhaled in higher concentration. The chlorine if leaks in liquid state it immediately gets evaporated at atmospheric pressure and occupies 350 times volume. Further this gas is 2 1/2 times heavier than air due to which it does not get dispersed easily. Such behavior of this gas aggravates the situation during the leak.

This situation may arise in any WTP if due care is not taken in planning, designing as well as in maintenance. In such situation a water supply engineer and the administering body may land in similar trouble faced by the TISCO's MD.

The Administrators are the facilitators for all required safety steps. Hence their active participation will change the present scenario.

The major cause of the unsafe situation in chlorination plant of water supply is lack of attention at all levels. But the excuse generally sought is "the special attention is required only when five or more cylinders are stored." This is not true. From the analysis of past leaks minimum safety precautions are required to be observed.

A chlorinating system shall be designed considering following aspects in details so as its hazard potential remains under control.

1. **Planning** - Adequate space for housing chlorine containers, chlorinating equipment, neutralization system Procurement of adequate breathing apparatus. The orientation of system considering direction of wind.
2. **Selection of proper equipment** - Special lifting tackle for loading & unloading containers from truck. The chlorine-carrying pipeline is suitable to required pressure rating. The chlorinating equipment is safe for operating. Safe storage arrangements for filled as well as empty containers. Leak detection system. Emergency handling tools and gadgets.
3. **Selection of healthy operating staff**:- All the staff related to O & M shall not be the patient of Asthma or similar type of diseases.
4. **Training** - The O & M staff shall be trained for correct operating & handling the equipment.
5. **Emergency management** :- To define the activities to be done. Its sequence and time. Carrying out mock drill.
6. **Tendering** - Present specification of a Chlorination system do not cover the requirement. The specifications of a WTP have got a small chapter for this, which lacks in safety view. Such safety standards are laid down in case of general construction work.
7. **Standardizing chlorinator** :- Granting approval to the manufacturers and their products so that acceptance to poor quality is eliminated.
8. **Upgradation of existing plants** :- Only adopting improved system in future plant is only half done. The threat of hazard exists from old systems also. Hence a program of upgradation is to be taken on anvil considering all above points.
9. **Ventilation System** :- A forced ventilation system covering normal situation and heavy leak. In emergencies about 15 air changes per hour are required.
10. **Layout of Chlorination Plant** :- The plant layout shall be to provide best natural ventilation, protection from Sun & Rain. Adequate space for maneuvering of vehical during unloading.

Introduction

"It is the responsibility of the management to create a safety atmosphere and culture among the staff. Increase the confidence level of staff for using safety tools and facilities. Such awareness will be achieved only if there is active participation from everybody of the organization from top to bottom."

News in the Times of India on Oct 5, 1999 that attracted my attention that reads as follows

"A lower court in Jamshedpur sentenced the Tata iron and Steel company Limited, (TISCO) managing director and occupier, Dr. Jamshed J. Irani, and the company's former general manager (works) P.N. Roy to two year simple imprisonment

for the death of a shunting jamadar on duty. They have been convicted under section 92 of the Factories Act, 1948. The court of 1st class judicial magistrate has also fined the Tisco M D and the G M Rs one lakh each."

This news attracted my attention as liquid chlorine is normally used as disinfectant in water supply and much attention is not given towards planning and installation of its plant. If proper care of chlorine plant is not taken there is a chance for an accident. This fear is not just hypothetical looking in to following incidents.

1. Last year there was an incident of chlorine leakage in a WTP during unloading a filled container from

the truck. Due to this leakage about 100 nearby residents required medical treatments. To avoid recurrence of such incident emphasis needs to be given on proper layout of a chlorinating plant.

2. In one of the "C" class municipal council the chlorine cylinders were purchased some 15 years back. The cylinders are full of chlorine gas (100 kg.), these cylinders remained unused for want of one or the other reason. These cylinders were stacked during the entire period in neglected condition. Now no body is taking steps to neutralize it. It is difficult & risky to transport and neutralize. Everybody is avoiding the responsibility. The status of the cylinder is becoming bad to worse. The gas may leak anytime and may be hazardous to near by residents. Although chlorine is not poisonous gas it affects respiratory system if inhaled in higher concentration.

The Chlorine

Chlorine at ambient temperature is gas, greenish yellow in colour and irritating odor. It is non-explosive and non-flammable but it is capable of supporting combustion of hydrogen and hydrocarbons. It is 2½ times heavier than air. Thus if it escapes from system it seeks the lowest level in the area. Although dry chlorine is not corrosive, it is strongly corrosive in presence of moisture. It is compressed and refrigerated to form its liquid and this liquid is filled in cylinder. If chlorine contaminated air is inhaled it gives irritation of throat, nose, and causes coughing.

The chlorine if leaks in liquid state it immediately gets evaporated at atmospheric pressure and occupies 350 times volume. Further this gas is 2½ times heavier than air due to which it does not get dispersed easily. Such behavior of this gas aggravates the situation during the leak.

Necessity of Safety Practices

This situation may arise in any WTP if due care is not taken in planning, designing as well as in maintenance. In such situation a water supply engineer and the administrating body may land in similar trouble faced by the TISCO's MD.

The Chlorine cylinder :

The chlorine gas under pressure turns in liquid form and this liquid is filled in the cylinder of capacity 100 kg or 900-kg. The 100-kg capacity cylinder is to be kept always in vertical position. It has only one outlet valve at the top and a threaded cap is provided to protect this valve during transportation.

The 900-kg capacity cylinder is cylindrical in shape and has concave ends with two outlet valves. These are connected to with an education pipe fitted inside. This Cylinder is to be kept always in horizontal position with its valves in vertical line. The top valve will deliver gas and liquid from the lower valves. A steel hood is fixed to protect these valves. This hood is to be fixed to its place when it is not connected. This is vry important when the cylinder is transported. The weight of empty cylinder is about 600 kg and the filled one weighs about 1500 kg.

Statutory requirement

As per Indian Gas Rules, 1981 for storing five or more cylinders in a plant, a certificate from the Director of Explosives GOI is essential. The Factory Act governs a plant employing more than 10 workers. In such situation layout of the plant is to get approved from the Chief Inspector of Factories.

Normally when the storage of cylinders is less than five for the WTP capacities up to 100 MLD, the approval of the Director of Explosive is not necessary. However when the workers at WTP including those for operating pumps etc. are more than 10, approval of the Inspector of Factories is essential.

Proper planning and layout of chlorination plant covering following points will create safe working atmosphere.

1. *Selection of plant* - The limit of withdrawal rate of chorine at atmospheric pressure and ambient temp through a 900 kg cylinder is 6.5 to 7.5 kg/hr and 0.9 kg/hr in case of 100 kg cylinder. The requirement of feed rate of chlorine and this limit decides the number of cylinders to be stored. However for any capacity three cylinders are required.

2. *Space planning* - Adequate space for storing cylinder on storage platform, chlorinator room, neutralization tank, ample space for maneuvering the truck during loading/unloading operation.

3. *Location of plant* - The plant shall be located downward of wind direction in the given plot of WTP. In case of contamination of air due to any chlorine leakage this arrangement will not affect other activities in a WTP.

4. *BIS standards*

IS : 4263 - 1967 Code of safety for chlorine

IS : 10553 - 1983 Requirements for Chlorination equipment

Chlorination Plant

The chlorine plant is inclusive of

1. Chlorine cylinder storage platform
2. Lifting arrangement
3. Chlorinator room.

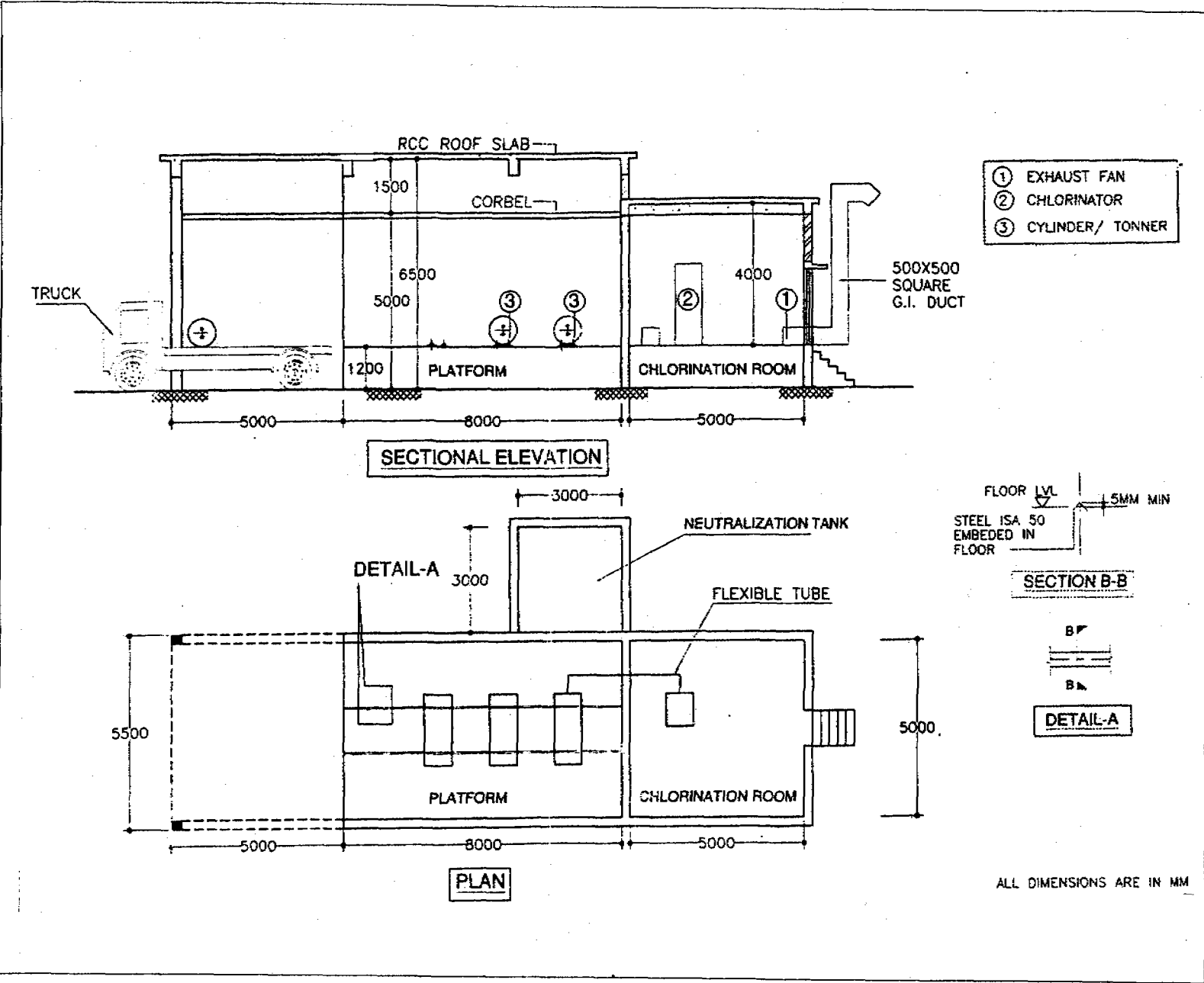

Fig. 1 — Suggestive Layout of Chlorination Plant.

4. Piping
5. Diffuser arrangement

Cylinder storage platform

The size of a storage platform shall be suitable for minimum three cylinders. One on line second filled for replacement when first is exhausted and third empty waiting to get transported to filling station. The actual requirement shall be decided taking into consideration maximum dose of chlorine number of cylinders required for consumption in one cycle of supply of receipt of filled cylinders. Adequate space is required around each cylinder for inspection.

The platform floor shall be 1.2 m above ground level for rolling in and out the cylinder from truck. A ramp is also necessary for loading/unloading in case of failure of lifting tackle.

Two longitudinal steel angles are to be embedded in the c.c. Flooring. The edge of the embedded angle shall be protruding at least 5 mm above the top level. The floor will not get damaged while rolling the cylinder as and when required. This arrangement also reduces the efforts while rolling. (Ref details in figure no. 1 as section B-B.)

A pair of trunnion roller supports is to be provided. (Refer figure no. 3) The cylinder is required to be rotated to bring its two control valves in plumb so that only gas will come out from the upper most valves. Due to this trunnion arrangement the cylinder can be rotated by single worker to desired angle and also will hold the cylinder in its place. (Ref. drawing no. 1)

The stored chlorine cylinder needs protection from sun and rain, as chlorine is heavier than air it remains near floor level. Hence the top of the platform shall have roof with side walls having ventilators at floor level.

Lifting arrangement :

The H O T arrangement of 2 tonne capacity covering the entire area of storage platform and extended to about 5 m beyond it to facilitate the loading / unloading from the truck. Lifting beam only shall be used to lift the cylinder. (Refer figure no. 2) The steel wire rope or chain shall never be used for lifting. The general arrangement is shown in drawing no. 1

Chlorinator room & Ventilation :

The chlorinator room shall be adequate to accommodate two chlorinators' one working and one standby with its accessories like pumps, panel etc. The suggestive size is shown in drawing no. 1. The room shall have natural ventilation arrangement with windows at floor level. The artificial arrangement for forced ventilation is to be provided with exhaust fan fitted at 15 cm above floor level and designed to have at least 4-6

air changes per hour and 15-20 air changes per hour in case of emergency and heavy leak. The exhaust of this ventilation arrangement shall be collected through suitable size duct and released at rooftop.

The exhaust fans shall be either epoxy coated or fabricated of PVC with its motors having flame proof protection.

Selection of suitable equipment

The vacuum type of chlorinator do not permit leakage beyond vacuum regulator and hence more safe than other type. (Gravity feed etc.) Hence use of vacuum type chlorinator is recommended. The chlorinator shall have 100% standby to have continuity in operation and flexibility in maintenance.

The chlorinators shall be suitable for continuous operation and of capacity to meet maximum feed rate required and conforming to relevant B I S specification.

All metal parts shall be of silver, Monel and nut bolts of stainless steel. The components exposed to chlorine shall be of silver-plated, Hastelloy 'C', ABS, PVC, PTFE, and Tantalum. The injector block shall be of ABS or any other approved material strong enough to withstand corrosive action of chlorine and water and does not have abrasive action due to high velocity. The pump to the chlorinator shall be suitable so that the outlet concentration do not exceed 2800 RPM.

The short listing of manufacturers of all equipment preferably chlorinators, breathing apparatus, emergency kits shall be carried out. The equipment from approved list only is permitted for selection.

The third party inspection clause be introduced in early stage till staff gets conversant with pre dispatch inspection in factory.

Gas pipe :

The chlorinator shall be connected through copper flexible pipe of length not more than 1.2 m. The flexible tube to the cylinder shall be connected with help of yoke and not screwed directly to control valve on cylinder. The pipes carrying chlorine from platform to room shall be Seamless pipes confirming to ASTM grade A, or B schedule 80 or above. The fittings shall be of 2000 CPW forged carbon steel either screwed or flanged.

Adequate specification during execution - The Plant safety can be assured with specifying the chlorinating plant covering all the requirements discussed in paragraph and check points like approval to drawing etc. be introduced to confirm the desired result.

Upgrading present status of existing facilities can be done on above lines. The situation will decide the type of improvements. However, a phased program to adopt all recommendation with in short time.

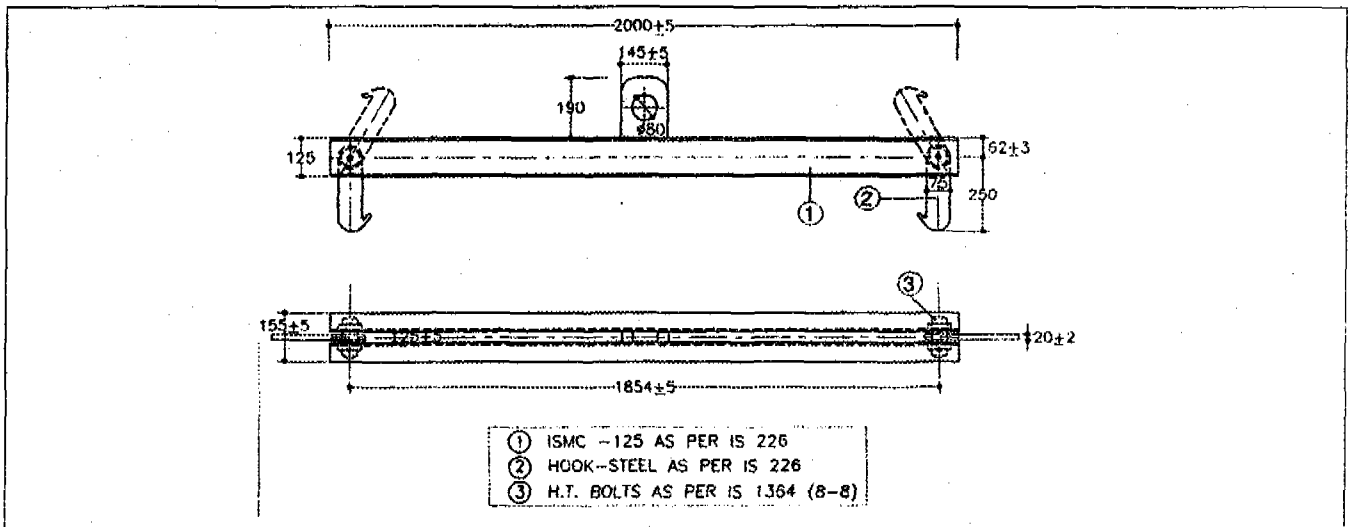

Fig. 2 — Lifting Beam to Handle Tonner (Max. Wt. = 1600 Kgs.)

Diffuser arrangement

The outlet from a chlorinator is concentrated solution. The proper mixing of this solution with water is possible when it is released evenly. This will improve quality of water. The arrangement of perforated pipe or mechanical diffuser are effective.

Safety Equipment

Following safety equipment are necessary at each plant

1. Canister type gas mask - minimum - 3 nos
2. Emergency Kit to stop leakage from cylinder valve, - 1 no
3. Self Breathing unit
4. Leak detectors
5. Neutralization tank.

There is confusion in construction of this tank. It is not advisable to roll in a leaky cylinder in tank either filled with water or caustic soda. The wet chlorine is highly corrosive. The surrounding water and chlorine will attack the metal near leak. This will increase the rate of leak instead of retarding it. The best way is to divert the contaminated air by artificial means and the solution is kept agitating. The compressed air or mechanical agitation arrangement is necessary.

High tech Equipment

The chlorine leak detectors are available. This unit collects air sample from near by air, analyzes it and displays the status of air. The concentration of contamination will be displayed and an alarm can be set in case the contamination crosses 3 PPM. This type

of units are costly and are successful if are located near leakage, and contaminated air reaches it.

Operational safety of Plant

The operating staff must cultivate habit of checking leakage every hour from all joints and susceptible parts with liquor ammonia swab. The white fumes will indicate leakage. Immediate action of rectification should be given to priority.

The valve cap and hood shall be rigidly placed in its position when a cylinder is not in use. While connecting a cylinder the valves shall be in vertical line. (Ref. Drg. 2)

Health

The worker responsible shall be free from any disability in respiratory system. The worker with asthma may not be permitted to work in WTP, he may be entrusted with different work. This has been stipulated in IS - 4263/ 1967. It is a surprise to note that after 33 years it is not defined as criteria for selection.

After inhaling contaminated air, the person may be shifted away from the location. He may be asked to deep breathe as far as possible. He may be allowed to drink water or any other liquid.

Training of O & M Staff -

After providing a proper plant an exhaustive training in safe operating and handling will improve confidence level among staff handling the plant. Also training will develop awareness in staff to use safety equipment. Such training shall be mandatory to staff of all cader. The person on site only can take corrective action.

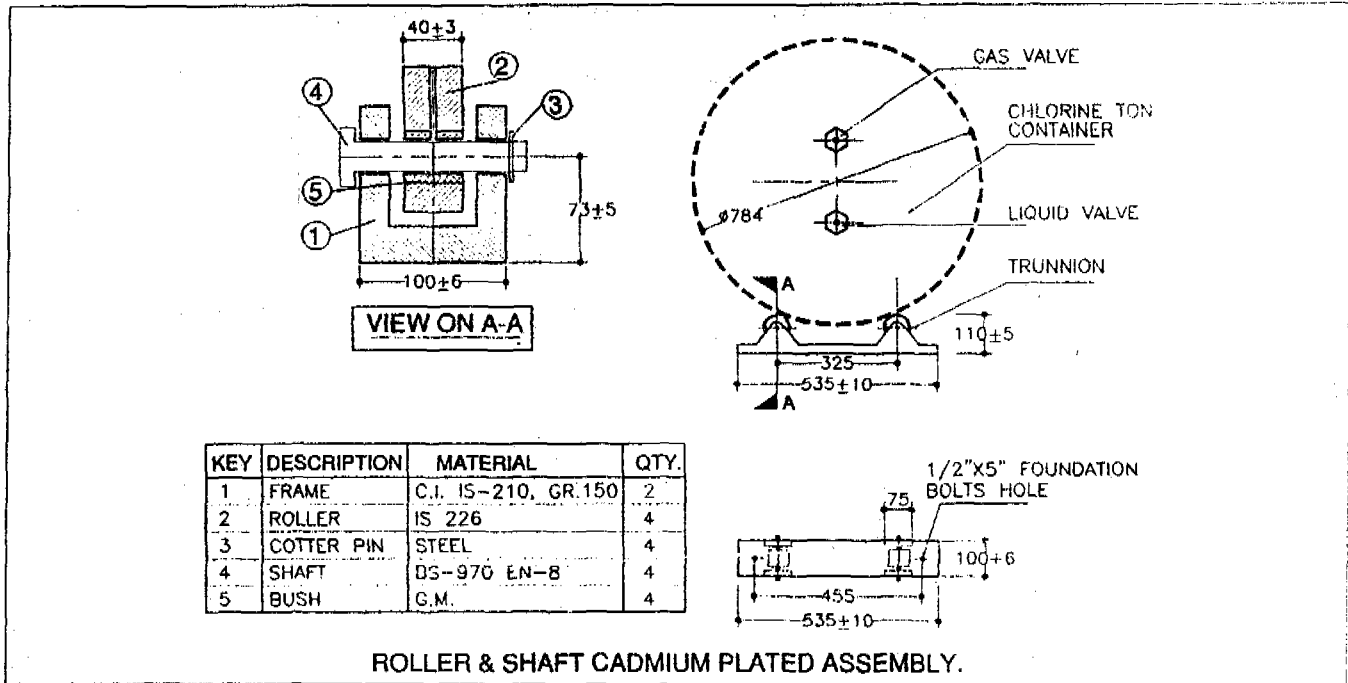

Fig. 3 — Trunnion Roller Supports.

The workers employed in a WTP must be trained for operating the chlorinator, safe handling of chlorine tonner, carrying out small repairs, use of emergency kit, use of gas mask, use of self breathing apparatus. The experts from manufacturer may be called for giving training. The fast moving and vital spare parts need to be kept in stock. The spare parts be purchased from manufacturer only. The local fabrication of spare parts may not be used as it is difficult to test the quality of material used.

The periodical mock drill by stimulating leakage is useful. Completing the exercise within stipulated time will indicate the fitness of staff to tackle the situation. A citation or incentive will keep staff active.

Training in emergency management -

The chlorine affects respiratory system. The worker may be required to work in chlorine contaminated atmosphere. He is required to invite habit of deep breathing. A worker shall never be attending the repairs alone. He should be accompanied with his assistant or colleague. In case of emergency he will run back to seek the help. The regular mock drill with a periodicity of atleast one year be carried out. This training is necessary to all those working in WTP.

Third party Insurance

Providing third party insurance cover to safe guard hazard potential. This will also provide a cover on

accident. This is preferable in case a WTP is surrounded by residential colonies.

Alternative

The on site generation of chlorine in case of small capacity WTP may be economical. The electrolysis of common salt will give Chlorine. The cost of such plant is more due to lack of commercial demand. This may come down as demand is increased. At this stage also the cost of such plant when compared with conventional plant added with cost of hazard potential may be economical.

Conclusion

Adopting the safety stapes e.g. 1. Proper planning 2. Proper layout 3. Selection of suitable equipment 4. Adequate specification during execution 5. Training of O & M staffs 6. Upgrading present status of existing facilities 7. Training in emergency management 8. Providing third party insurance cover to safe guard hazard potential can create the safe atmosphere hence needs to be followed.

Acknowledgement

The alkali Manufacture's Association, Mumbai
The Loss Prevention Association of India, Chennai.
The Chlorine Manual, The Chlorine Institute Inc
USA.
IS 4263 & 10553.

Electrochlorination System- An Welcome Change

Samiran Kr. Ghosh

Regional Sales Manger, Titanor Components Ltd.

Goa-403 115

Tel : (0832) 395340/41/42/43

E-mail : sales@titanor.com

Website : www.titanor.com

Impure water is perhaps the single largest cause behind many diseases which directly affect the well being of the community. In India it is estimated that water borne diseases claim about 73 million man days a year. Therefore it is imperative that water supplied to communities is treated so as to disinfect it.

Chlorine has been nearly an universal water disinfectant chemical for ages. None of the methods of water disinfection can match the versatility of chlorine which provides long lasting residual disinfection action. This property ensures that disinfected water remains safe to drink throughout the system - from the dosing point to consumers tap.

It was investigated about the biological activity of chlorine and established that in a concentration range between 0.2 & 0.5 ppm chlorine will efficiently disinfect water in public distribution system. Evidence was presented that the disinfection effect of chlorine is based upon the fact that bacterial enzymes necessary for oxidation of glucose are blocked. The small chlorine molecules can penetrate the bacterial membrane of the cell & react with glucose-oxidising enzymes. A contact of half a minute is sufficient to reduce the bacterial oxidation of glucose by 95%, whereas a reaction time of 5 minute is sufficient to kill bacteria. Chlorine proved to be an effective disinfectant for intestinal protozoa, schistosoma and a number of viruses, such as Poliomyelitis giardia & hepatitis viruses. Only a few germs such as protozoan giardia lamblia are resistant to chlorine.

The formation of by products, however, in the course of chlorination of drinking water and the detection of side effects, if any, give rise to manifold discussions among both the experts & the public. Search for effective alternative also continues. Some methods are :

Chlorine dioxide - effective or even superior & is largely ph- independent, but formation of polar compounds such as aldehydes, ketones, acids are detrimental & not safe for babies. Cost of treatment are 3 to 4 times as high as chlorination.

Chloramines-less effective than chlorine dioxide, furthermore have an algicidous effect. Higher efficacy observed at lower ph value. Major disadvantage of

chloramine is their deteriorating effect on taste & odour.

Ozone - is strong disinfectant & ensure taste & odour, microfloculation effect. But major disadvantage is regrowth within water supply systems & formation of number of toxic compounds. Moreover not all organic compounds will be reduced or even mineralized. Ozonization of benzol derivatives & ozonization of higher aromatic hydrocarbons results in a broad variety of organic compounds such as alcohols aldehydes ketones carbon acids, peroxyacids, ozonides & epoxides, quite a number of which may be mutagenic and or carcinogenic.

In the light of these it is incontestable that chlorination of drinking water remains as one of the biggest successes of sanitation achieved. The comparison with alternative drinking water disinfection other than chlorination reveals that in all other procedures by-products are formed which constitute a considerable health hazards & are liable to provoke mutagenic or carcinogenic effects.

It does not seem that a genuine alternative for the appropriate chlorination of drinking water exists. To achieve this accuracy of chlorination, it is imperative to install systems which incorporates the predesigned strength, purity of chlorine & precision dosing arrangement ELECTROCHLORINATORS (SEACLOR MAC) now used in INDIA since 95-96 have therefore brought about an welcome change from ageold conventional systems & have been able to establish a safe, pure, hazardless & economic chlorination programme in each establishment. Users have an unique facility to generate chlorine on site in the form of very safe to handle neutral, caustic free hypochlorite as & when and in quantities desired.

ELECTROLYTICALLY generated hypochlorite solutions could be used safely in a broad spectrum of applications requiring chlorination.

The chemistry of the process for all electrochlorinator is based on partial electrolysis of common salt (NaCl) (brine solution) as it flows between direct current (DC) energised anodic & cathodic electrodes which is housed in an electrolyser chamber. On successive chemical reaction, the common salt splits and forms sodium hypochlorite solution (NaOCl)

with a release of very small quantity of hydrogen gas - the electrochemical process & chemical reactions are as under :

On passing a DC through an aqueous solution of sodium chloride (NaCl) which is totally dissociated to Na + Cl

A. Free chlorine is generated at the anode
 $2 \text{Cl}^- \rightarrow \text{Cl}_2 + 2 \text{e}^-$

B. Hydrogen is evolved at the cathode with the corresponding formation of OH ions
 $2\text{H}_2\text{O} + 2 \text{e}^- \rightarrow 2 \text{OH}^- + \text{H}_2$

OH ions migrate from the cathode area & react with $\text{Na}^+ + \text{Cl}_2$ near the anode, Producing sodium hypochlorite (NaClO).

C. The overall chemical reaction can be expressed as follows :



The hypochlorite ions represent the "free chlorine". This free chlorine reacts with a multitude of inorganic & organic compounds. This may be oxidation or incorporation of chlorine into the organic molecule, resulting in the formation of new chlorinated organic compounds. 90% of the added chlorine exercise an oxidating effect. Dependent on contact with organic micro pollutants the remaining 10% form halogenated organic reaction products.

The major advantages of Electrochlorination System :

1. Onsite generation of chlorine instantaneously by electrolysis of common salt. Safe & No presence of unwanted chemicals. No fear of using unwanted, unknown hazardous chemicals with brought out chlorine.
2. Reliable & user friendly.

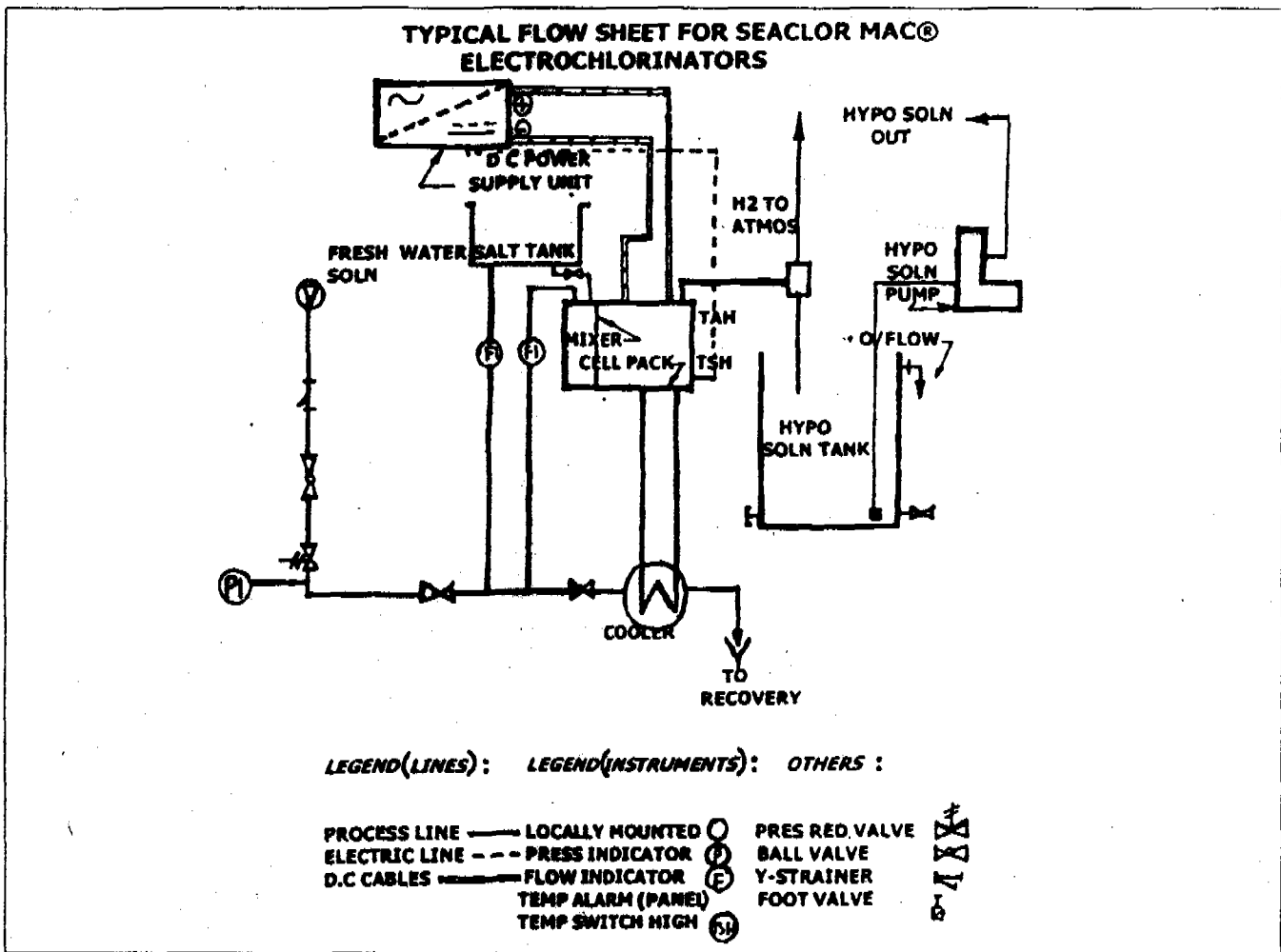

3. Zero pollution, absolutely safe to handle neutral caustic free sodium hypochlorite.
4. No chemicals used except common salt.
5. No solid waste disposal.
6. No stocking or storage planning required.
7. Very low operating cost, attractive pay back period. Can chlorinate 100000 LTR water for a cost of mineral water bottle.
8. Accurate & controlled dosing thro metering pump guarantees desired level of chlorination round the clock.
9. Special activation technology (DSA®) protects the electrodes continuously dipped in highly corrosive brine & hypochlorite solution from withering with time.
10. 4 to 4.5 kg common crystal salt & 4 to 4.5 KWH power only require to produce 1 kg active chlorine.
11. The plants have no moving parts, hence very easy to maintain.
12. Various models available to suit any public water distribution scheme (0.36 MGD to 10.52 MGD water at 1 PPM could be chlorinated by single unit)

Electrochlorination - Comparison with other practiced systems

Chlorine Gas	bleaching Powder	Readymade Hypochlorite	Electrochlorinator
<ul style="list-style-type: none"> • Risky, fatal • dependent on supplier • storing reqd. • hazards in handling & storage 	<ul style="list-style-type: none"> - dependent on supplier storing reqd hazards in handling & storage 	<ul style="list-style-type: none"> - dependent on supplier storing reqd hazards in handling & storage 	<ul style="list-style-type: none"> absolutely safe no dependence storing not reqd no hazards, produced instantly.
<ul style="list-style-type: none"> • 	<ul style="list-style-type: none"> looses concentration with time rapidly 	<ul style="list-style-type: none"> looses concentration with time rapidly 	<ul style="list-style-type: none"> no loss, low concentration causes slow depletion of strength
<ul style="list-style-type: none"> • 	<ul style="list-style-type: none"> exact concentration unknown during dosing 	<ul style="list-style-type: none"> exact concentration unknown during dosing 	<ul style="list-style-type: none"> known predesigned strength ensure correct dosing all the time

The chlorination by ELECTROCHLORINATOR thus have the distinction of only effective solution for water disinfection in public distribution system. More over since the common salt is the only raw material this could be very effective in rural areas apart from urban utilisation. The simple electrochemical processes do not produce any other chemicals thereby ensure zero pollution & is free from impurities & very stable in nature. Stability & purity both are very important factor to be considered before dosing into the public distribution system, since health hazards for community & recontamination in the distribution line should be primarily avoided.

It is recommended to control protective measures regularly with appropriate TEST SYSTEM and the

quality of raw materials for ELECTROCHLORINATOR. The common salt & fresh water for preparation of hypochlorite solution, should be inspected from time to time.

The technically possible and economically practicable reduction of potential hazards could be achieved thro ELECTROLYTICALLY GENERATED HYPOCHLORITE SOLUTION THRO METHOD OF ELECTROCHLORINATION SYSTEM.

This new technology may be tried in public water distribution system for its simplicity, on site generation facility, stability of chlorine, easy maintenance & cost effectiveness.

Reference

Products in drinking water chlorination by MR KLAUS STROBEL, GDR, WHO COLLABORATING CENTER.