

822-ING5  
C

# MOTIVATION

# MASONRY

and

# MONITORING



822-ING5-13284

LIBRARY  
INTERNATIONAL REFERENCE CENTRE  
FOR COMMUNITY WATER SUPPLY AND  
**POCKET BOOK FOR MASONS ON  
MOTIVATION, MASONRY AND MONITORING**

*About This Book*

This book which consists of three sections, namely *Motivation, Masonry and Monitoring*, can be used as a guidebook

by Masons during the construction of pour-flush waterseal latrines and other sanitary facilities such as garbage and soakage pits.

The book also provides information on the seven components of sanitation and lists out those aspects of different components of sanitation which should be taken up by the Mason for motivation. The last section of the book on 'Monitoring' highlights important indicators which the Mason can monitor during her/his interaction with members of the community.

The vertical edges of the pages in the three sections have been marked with different colours for easy identification.

ISBN 13284

LD: 322 IN95

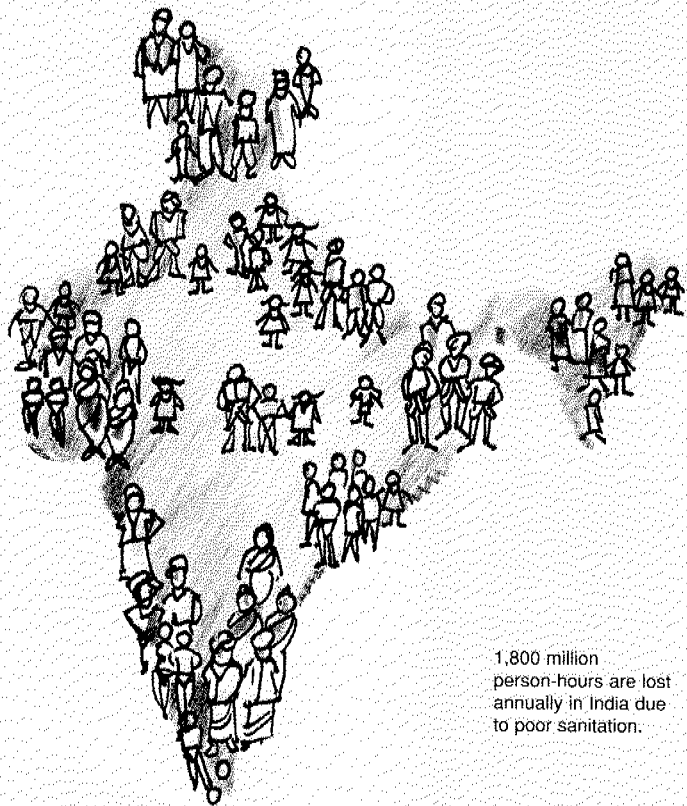

1,800 million  
person-hours are lost  
annually in India due  
to poor sanitation.

## Why Sanitation?

**ACCORDING** to WHO statistics, 80 per cent of the diseases, including cholera, typhoid, hepatitis, polio and diarrhoea, are caused by unsafe water and poor sanitation.

There are conclusive evidences to show that providing a safe water source is not enough to reduce the incidence of these water and sanitation related diseases.

A large majority of these diseases are spread through faecal-oral transmission routes and can be controlled by the adoption of sanitary practices.

An estimated, 1,800 million person hours are lost annually in India due to these diseases.

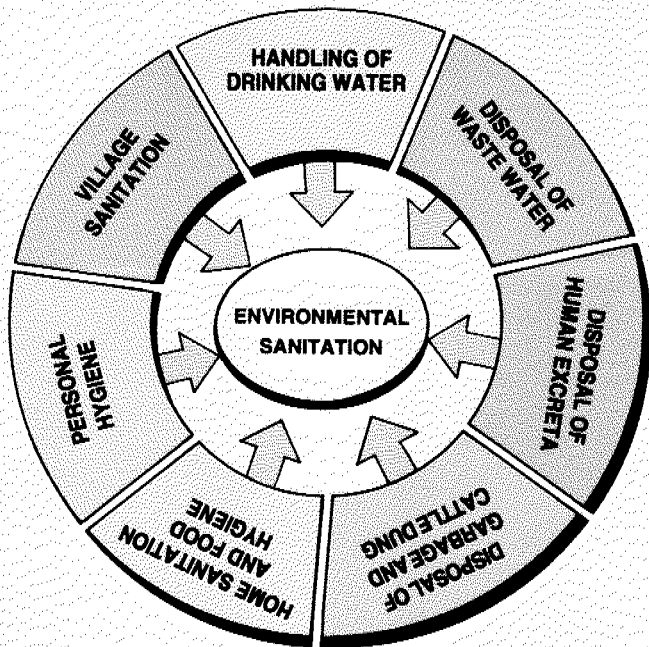

## What Is Sanitation?

**MANY** people identify sanitation with the construction of a latrine alone. Though exposed human excreta is one of the major causes of disease transmission, the use of latrines does not always control the spread of diseases linked to poor sanitation. The word 'sanitation' is therefore used to define a package of health-related measures, covering seven distinct components.

They are:

- ★ Handling of drinking water
- ★ Disposal of waste water
- ★ Disposal of human excreta
- ★ Disposal of garbage and cattle dung
- ★ Home sanitation and food hygiene
- ★ Personal hygiene
- ★ Village sanitation.

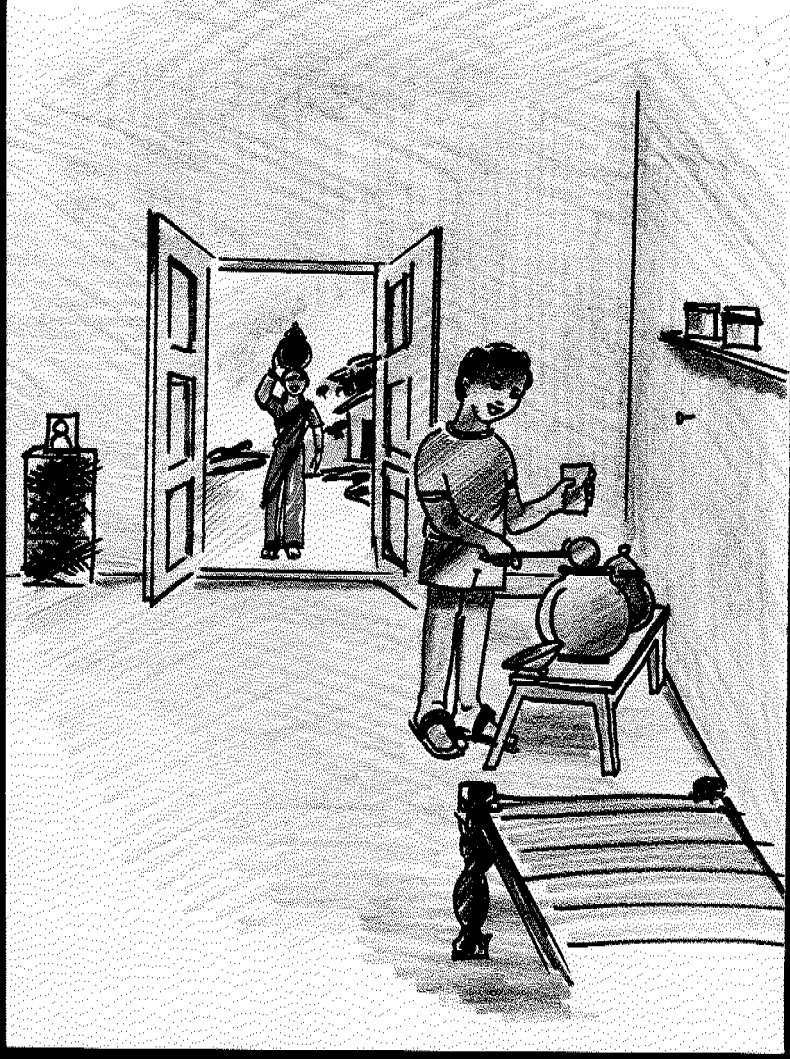

# Handling Of Drinking Water

**PROTECTED** sources like handpumps, taps and sanitary wells provide safe water which can be used for cooking and drinking. However, the safe water from these protected sources too can get contaminated if not handled properly. Drinking water contaminated due to improper handling can lead to many kinds of diseases including diarrhoea, dysentery, cholera, etc. It is therefore important that measures are taken to keep water from safe sources free from contamination from the time it is collected till the time it is consumed.

## → **What you as a motivator can do**

Motivate the people to:

- *Collect water from a safe source like a handpump, tap or sanitary well.*
- *Collect water in a clean vessel. Care must be taken not to dip fingers into water while lifting the vessel.*
- *Cover the vessel while carrying water from the source to the house.*



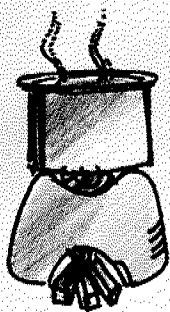

- Store the water at home in a clean, covered vessel, above the ground level.
- Use a ladle to take the water out or store water in a long necked surahi.
- Boil the water for 20 minutes, or chlorinate it, if the drinking water is collected from unsafe sources. Boiling and chlorination of water help in killing the disease-causing organisms.

To chlorinate water:

- Drop two Chlorine tablets in an earthen pot in which drinking water is collected.
- Cover the pot and shake it gently.
- Let the water remain untouched for two to three hours.
- The water is now fit for drinking.

**Note:**

- ★ Chlorination must not be done in metal containers.
- ★ Chlorine tablets must be protected from sunlight and kept out of the reach of children.

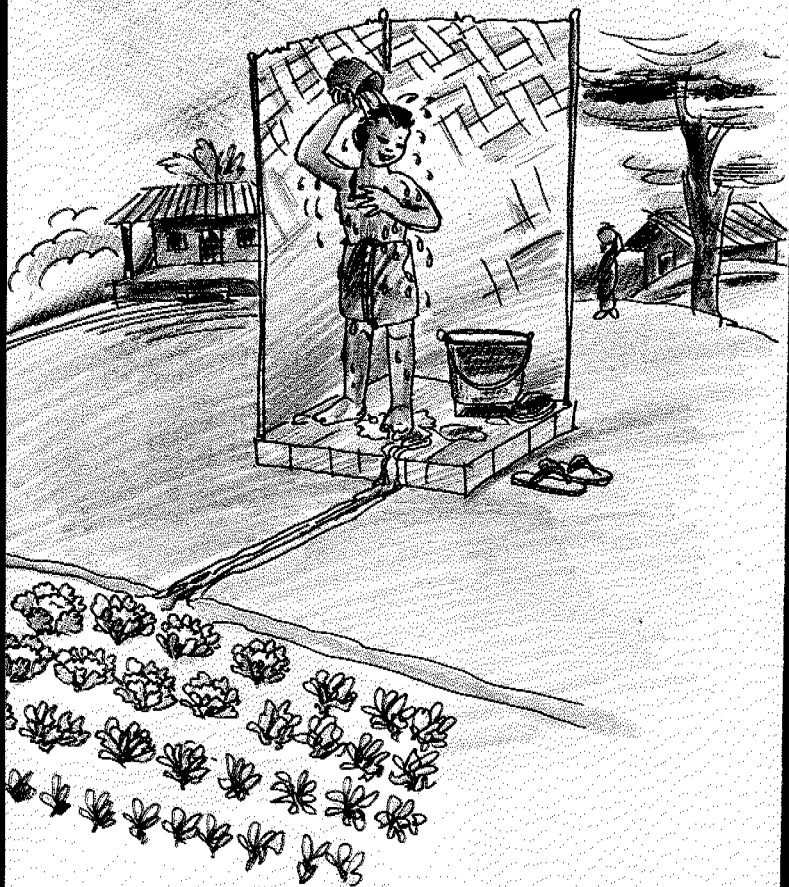

## Disposal Of Waste Water

**STAGNANT** water looks dirty, smells foul and is a threat to the environment as it can seep through the soil and contaminate ground water. Mosquitoes breed in stagnant water and spread diseases such as malaria and filariasis.

### ➔ What you as a motivator can do

Motivate the people to:

- *Construct a drain to channel the household waste water into a kitchen garden; or construct a soakage pit to dispose waste water from the kitchen or bathing cubicle; or build a drain from the kitchen or bathing cubicle to a natural drain.*
- *Maintain the soakage pit so that it does not spill.*
- *Regularly clean the household drain leading to the natural drain or kitchen garden, so that it does not overflow.*
- *Construct the cattle shed at some distance away from the house and add a drain to lead the animal urine from the shed into a soakage pit.*

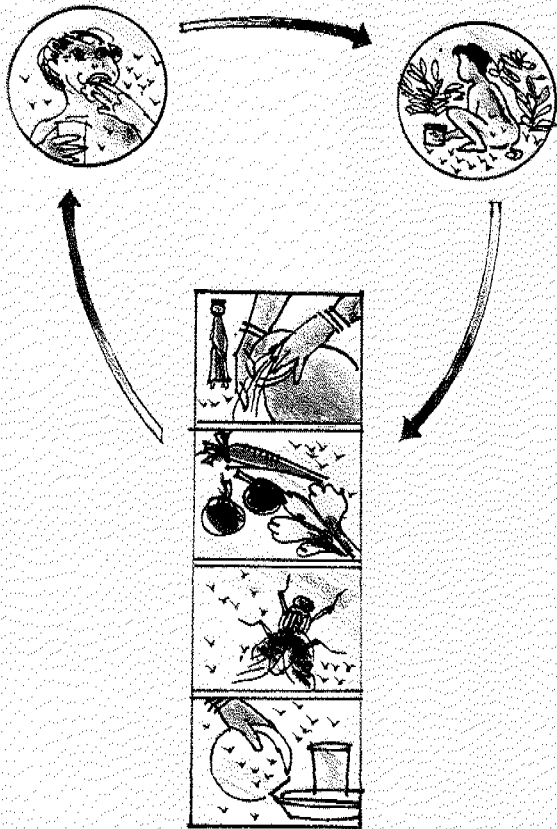

*Harmful organisms, not visible to the naked eye, are transmitted to people through drinking water, unwashed vegetables, dirty hands and insects such as flies, cockroaches, etc.*

## Disposal Of Human Excreta

**ACCORDING** to the 44th round of the National Sample Survey, in rural areas of India, about 90 per cent people defecate outdoors. Even in urban areas nearly 40 per cent people defecate in the open. Open defecation is much higher among children. In fact, children and toddlers often defecate just outside their house, in a drain or on the street.

Many people believe that children's excreta is harmless. This is not true. The excreta of a child is equally harmful, if not more, as that of an adult.

Many diseases are spread from human excreta lying exposed due to open defecation. Disease-causing organisms are present in the excreta of an infected person. These harmful organisms, which cannot be seen with the naked eye, are transmitted to people through drinking water, unwashed vegetables, dirty hands and insects such as flies, cockroaches, etc. The diseases that are spread in these ways include several types of intestinal worms, diarrhoea, dysentery, cholera, typhoid, hepatitis and polio.



Use of a sanitary latrine controls the spread of diseases caused by open excreta and helps to maintain a clean and healthy environment.

People defecating in the open have no protection against insect and animal bites and other hazards. A sanitary latrine provides protection from insects and animals.

Nowadays, many of the woods and bushes have disappeared as more and more land is being developed for cultivation and town/city expansion. Women, therefore, have to go out before dawn or wait till after dusk for defecation. Going out at these odd hours is not safe. If they have the urge during the day, they have to suppress it. This is painful and harmful to health.

A sanitary latrine provides a secure, private and convenient place for defecation.

➔ **What you as a motivator can do**

Motivate the people to:

- *Construct household latrines on their own, without waiting for Government subsidy.*
- *Choose from a range of latrine designs suitable to the area and affordable by them.*
- *Train children above two years to use the latrine.*





- *Use the latrine to dispose infants' and children's excreta.*
- *Buy construction materials from the local rural sanitary mart, if such a mart exists in the area.*
- *Dig a small hole in the ground for defecation and cover the excreta with soil, if they have to resort to open defecation in the absence of a latrine.*



## Disposal Of Garbage And Cattle Dung

A **LARGE** percentage of infant deaths in India are due to tetanus. The germ that causes tetanus (lockjaw) lives in filth, particularly in cattle dung. The germs enter the body through an open wound. Newborn babies can get tetanus if the umbilical cord is cut with a dirty, unsterilised blade or if the wound, after the cord is cut, is smeared with animal dung. Tetanus can also be caused if the baby is delivered with unwashed hands and in dirty surroundings.

Piles of garbage and cattle dung lying around the house and on the streets provide a breeding ground for flies. They attract cockroaches, pigs, rats, dogs and other animals, which are carriers of various diseases. They block roads and drains. Water-logging due to garbage and dung facilitates breeding of mosquitoes which spread malaria and filariasis. Indiscriminate dumping of garbage also causes a serious environmental hazard.



**➔ What you as a motivator can do**

Motivate the people to:

- *Keep dustbins in the kitchen and in other parts of the house for collecting household garbage. Small cane baskets or cardboard/wooden boxes can be used as dustbins.*
- *Construct a garbage pit in the backyard into which the household garbage can be thrown.*
- *Dispose off cattle dung in the garbage pit.*
- *Convert garbage into compost using a garbage pit, and use the compost as a fertiliser in the kitchen garden.*

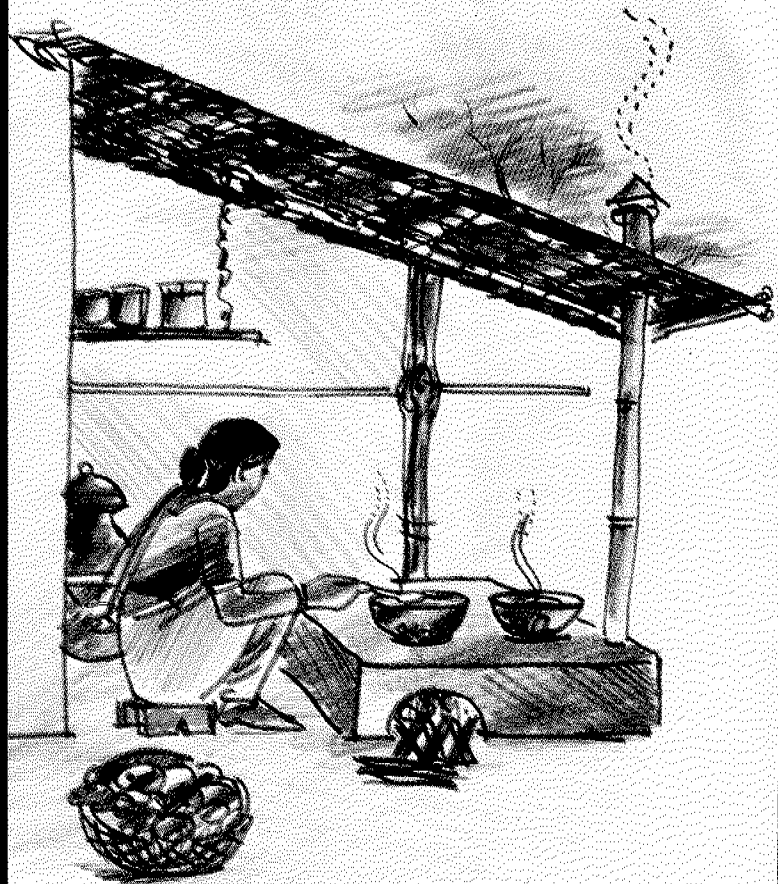

## Home Sanitation And Food Hygiene

**MANY** village homes are damp, dark and stuffy. They lack light and ventilation. There may be only one room in which the whole family has to live. Often, people and animals have to share the same roof.

In such living conditions it is important that home sanitation is maintained to prevent disease carriers such as rats, flies and cockroaches from entering the house.

Furthermore, the smoke from the conventional *chulha* (open stove) causes eye irritation and respiratory diseases, particularly among children and women. (Studies have shown that smoke inhaled by the housewife using a conventional *chula* for daily cooking is equivalent to smoking nearly 200 cigarettes per day.)

It is important to maintain food hygiene along with home sanitation. Vegetables and fruits are often contaminated due to open defecation in the fields.

Food left uncovered attracts flies and other insects which transmit diseases.



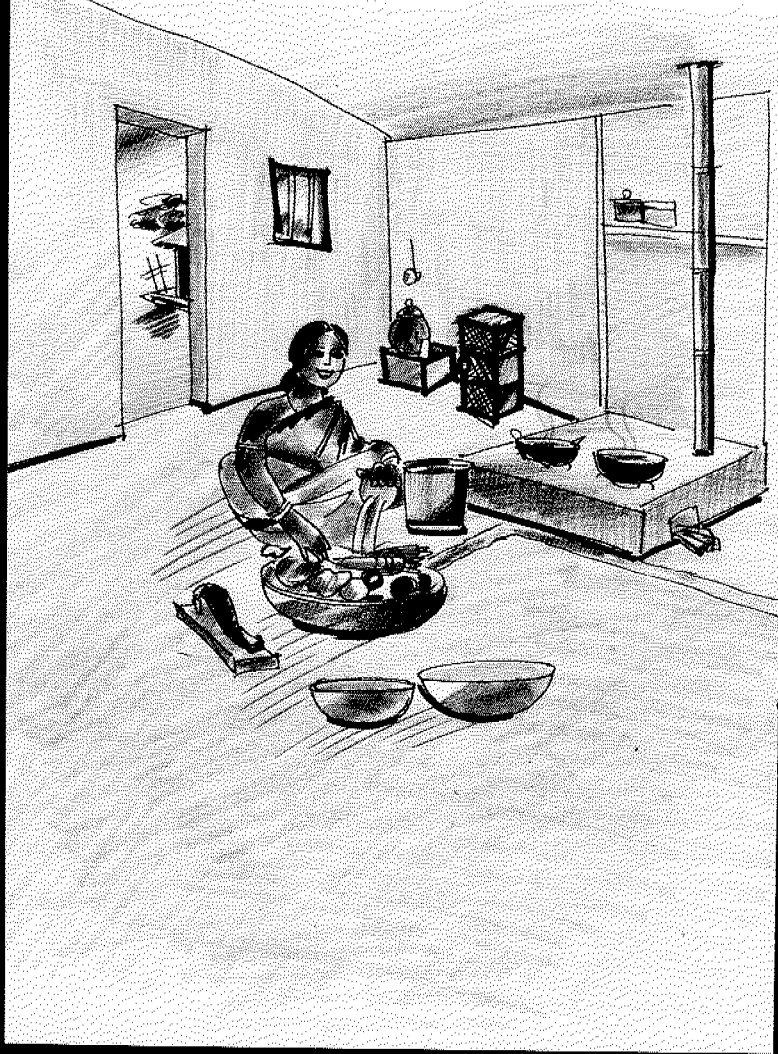

**➔ What you as a motivator can do**

Motivate the people to:

- *Ensure that the house is well ventilated to allow plenty of fresh air and light to come in.*
- *Keep the house clean by sweeping/swabbing it daily.*
- *Store food in a food safe.*
- *Keep cooked food covered.*
- *Wash raw vegetables and fruits before eating them.*
- *Use a smokeless chulha to allow the smoke to escape from a chimney.*
- *Remove the child's/infant's excreta immediately and dispose it off in a sanitary latrine or in a hole dug in the ground. The excreta should then be covered with soil.*

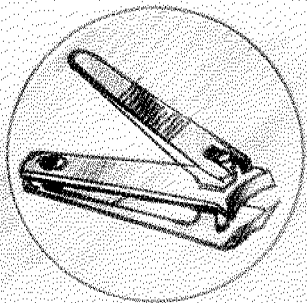

## Personal Hygiene

**MANY** diseases are caused by poor personal hygiene. Two important personal hygiene habits are: cutting nails frequently to prevent accumulation of dirt under them and washing hands with soap and water to keep them clean and free from infective organisms. If soap is not easily available, hands can be washed with ash and water to keep them clean. Use of mud for washing hands can lead to worm infestation as mud very often harbours worm larvae.

### ➔ **What you as a motivator can do**

Motivate the people to:

- *Wash hands with soap/ash and water after defecation, before eating, serving food, and feeding children and after disposing off children's excreta.*
- *Clip fingernails regularly using a nail cutter.*
- *Wear footwear while walking outdoors.*
- *Brush teeth daily, with a neem twig and some salt or with a toothbrush and paste.*
- *Bathe daily, using soap, and wear washed clothes.*
- *Use a handkerchief or the hand to cover the mouth while sneezing or coughing, to prevent spread of airborne diseases.*



# Village Sanitation

**FOR** sanitation to become a way of life, the village environment must be kept clean. Following the first six components of sanitation is not enough to ensure a clean village. For example, people may clean their own homes but throw the garbage onto the streets; household soakage pits may be constructed but not maintained, so that they spill onto the lanes; small children may defecate outside their own homes and into community drains and on the streets; the village drains may be water-logged; agricultural waste may be thrown on the streets; the market, school and other public places may be strewn with garbage, etc. In addition, water-logging at the community water points can create an environmental hazard. Lack of village drains can create water pools and provide a breeding ground for mosquitoes.

A clean village environment is thus a generic indicator of the hygiene practices of the people.

## ➔ **What you as a motivator can do**

Motivate the people to:

- *Stop open defecation by constructing household sanitary latrines.*



- *Stop throwing household garbage onto the streets and instead dispose it off in household garbage pits or in community garbage bins, placed on the roads and at public places.*
- *Ensure that the platforms and drains around the community water sources such as taps, handpumps and sanitary wells are in good condition and are cleaned regularly.*
- *Ensure that the surroundings of the platforms around the water sources are kept clean.*
- *Not allow household waste water to flow onto the streets, but divert it through drains into a kitchen garden or a natural drain.*
- *Construct road drains and connect them to the agricultural fields or to the natural drains.*
- *Take up village cleaning activities regularly.*
- *Construct sanitary latrines at the school and anganwadi centre in the village.*
- *Build sheds for the cattle and dispose off cattle dung in household/community garbage pits or use it in bio-gas plants to generate gas which can be used as fuel.*
- *Fill small puddles in the village with pebbles and mud to prevent further accumulation of water.*
- *Contribute voluntarily towards repair of handpumps, platforms and drains in their village.*



# Pour-flush latrine rear discharge

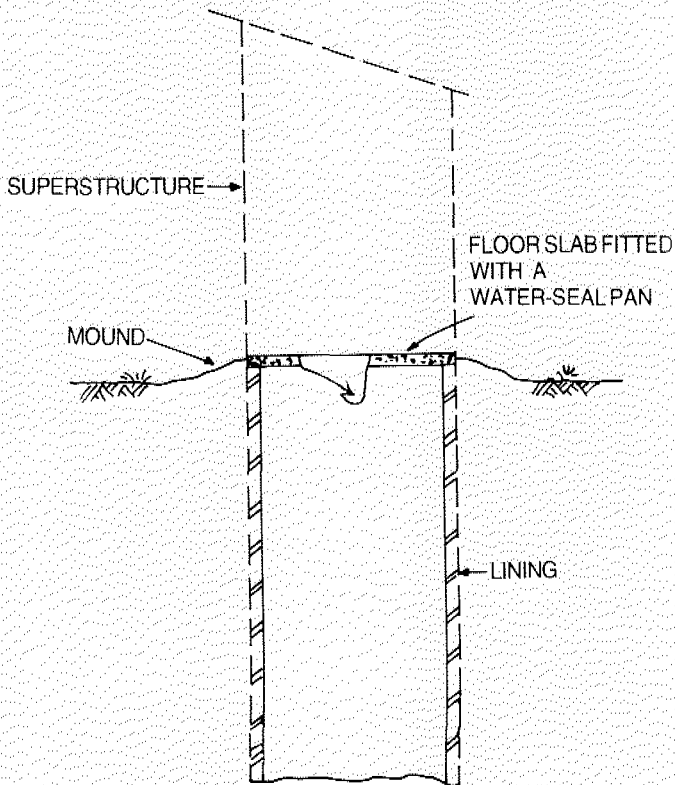

# Disposal Of Human Excreta

## HOW TO CONSTRUCT

### ■ A Direct Pit Waterseal Latrine

For this type of latrine, the squatting slab, fitted with a cement concrete pan, is manufactured at the production centre. At the construction site, a pit is dug and the squatting slab is placed over it. The steps involved in the construction of the direct pit waterseal latrine are given below:

- Use a mould for casting the cement concrete pan.
- **Pan:** Paint the outer surface of the mould with liquid paraffin to facilitate removal of the pan after setting. Pour cement/sand mortar (1:3) around the mould to make a pan of 12 mm thickness. Shape the mortar and finish with handwork using a trowel. After a setting time of one day, carefully detach the pan from the mould and cure it well. The pan is used for constructing the squatting slab.
- **Rectangular RCC Squatting Slab:** The finished dimensions of a rectangular slab are 1.2 m x 1 m x

## A rectangular squatting slab

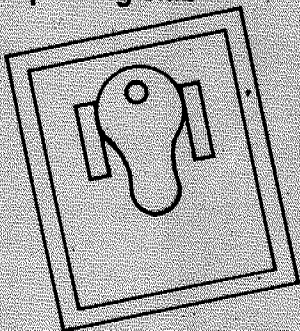

## Pit lining with RCC rings

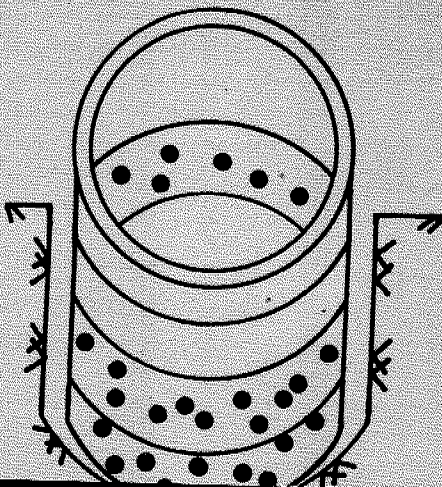

0.04 m. For construction, draw the outline of the slab and mark the position of the pan. Make a hole in the ground below the pan marking, big enough to accommodate it. Pour some sand in the hole for the pan to rest on. Place the pan in the hole and slowly manipulate so that the top of the pan is brought to the level of the desired finished surface of the slab. Once the pan is levelled, fill the gaps around the pan with sand and then compact.

Lay a waterproof sheet (tin or polyethylene) on the levelled ground. Cut a hole in the shape of the pan to bring the pan edge out. Place the casting frame (iron bar/angle or wooden frame) over the sheet. Place the reinforcement as per drawing and cast with concrete mixture (1:2:4). Allow the concrete to set and then cure it properly.

● **Pit:** Select a suitable site. Draw the outline of the squatting slab on the ground. Dig a pit within this outline (0.9 m internal diameter and 1 m clear depth). Stable and hard soil does not require a pit lining. For loose sandy and black cotton soil, a pit lining is provided to prevent the sides from collapsing. A 75 mm or 110 mm thick honeycomb brick lining is common for this purpose. Alternately, RCC rings or burnt clay rings can also be used. Local materials such

# A circular squatting slab

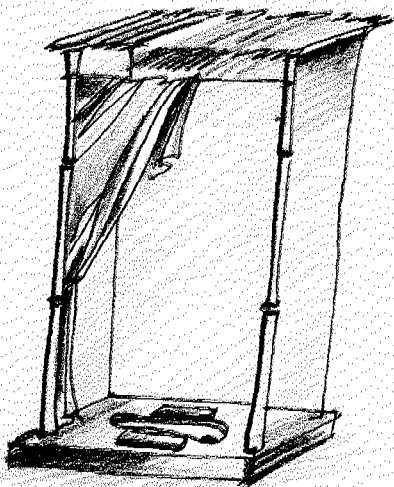
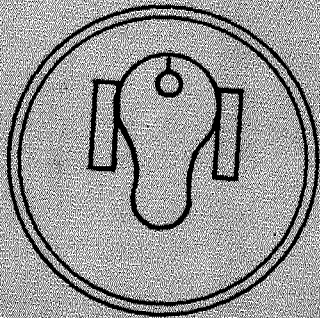

as bamboo matting, old drums, rubble masonry work, etc, can also be used for pit lining to reduce the cost. Place the squatting slab over the pit, once the pit is ready. Use a spirit level to check the horizontal level of the slab. If the horizontal level is not achieved, the required waterseal will not be ensured and the latrine will not function properly.

Circular RCC squatting slabs (1 m diameter x 0.04 m thickness) can also be used. In this case, a similar procedure is followed for constructing the pit. The diameter of the pit, however, should be 0.75 m instead of 0.9 m as mentioned in the case of rectangular slabs.

**Superstructure:** It is ideal to provide a temporary superstructure which can be easily shifted once the pit is full. Corrugated iron sheet and similar material are commonly used in the construction of this kind of a latrine superstructure. The ultimate choice of the superstructure will depend on the house-owner.

**(Do not construct a permanent superstructure over a direct pit latrine.)**

# Superstructure showing foundation details of a two-pit latrine

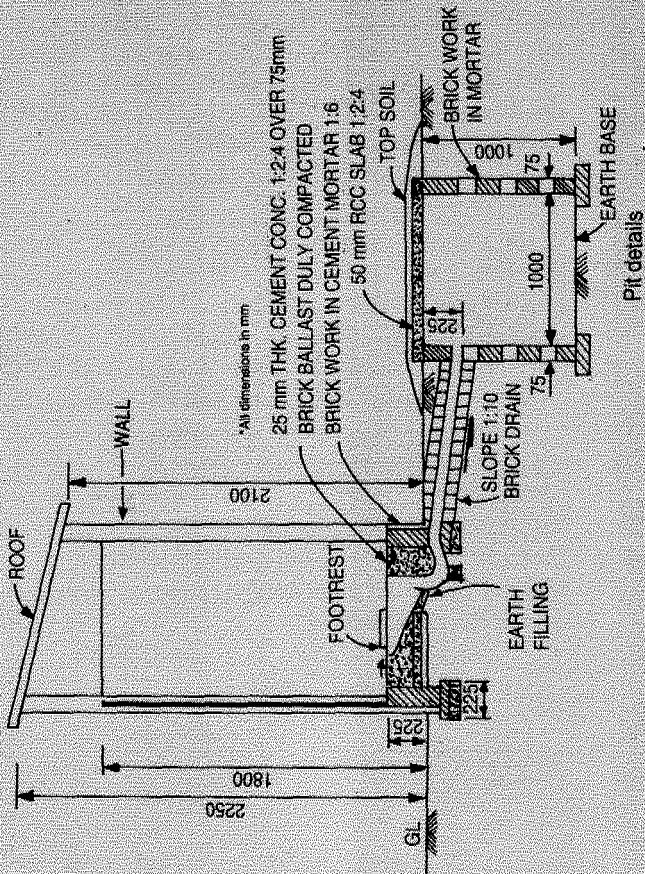

## ■ A Two-pit Pour Flush Waterseal Latrine

A standard drawing showing various components is given in the figure on the facing page. The depth of foundation may vary to suit soil characteristics and other local conditions. For example, the top of the platform should be raised in areas prone to flooding.

- Draw the plan on the ground showing the outer perimeter of the squatting platform, the junction chamber, the connecting drain and the two pits.
- Determine the level of various units such as the squatting platform, junction chamber and pits (keeping in view the slope).
- Make foundation trenches and carry out masonry construction.
- Place the P-trap in position and use a spirit level to ensure horizontal waterseal.
- Fix the pan with the P-trap and test for proper levelling by pouring water into the pan.
- Pack the gap between the pan and the platform wall firmly with soil and rubble to ensure that the pan, P-trap and waterseal remain in position.
- Complete the construction of platform with masonry work.
- Plaster the outsides of the platform with 20 mm



## Cross section — pit lining

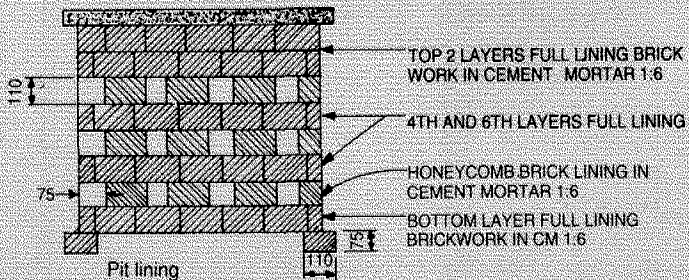

\*All dimensions in mm

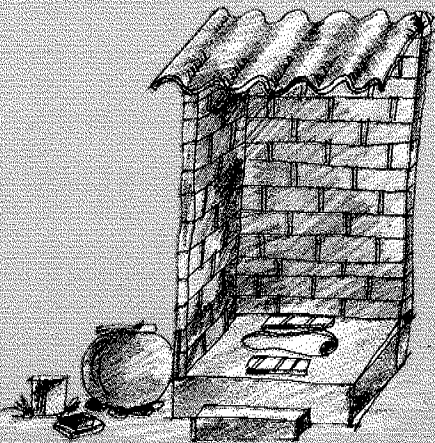

thick cement mortar.

- Lay the Y-shaped brick drain (75 mm wide) at a slope of 1:10 to ensure easy flow of excreta. A 75 mm diameter pipe, maintaining the same slope, can also be used.

- Construct foot-rests on the platform to facilitate use by both adults and children.

- Dig the leach pits, each of 1 m diameter and 1 m depth. For loose, sandy and black cotton soil, 75 mm or 110 mm brick lining should be constructed.

Alternative local materials can also be used for the lining. For stable soil, lining is provided only up to the top 0.3 m.

The pit cover can be made of bamboo with a mud cover, stone slabs, etc. Alternatively, a 50 mm thick RCC slab, with a 6 mm diameter steel rod as reinforcement, can be used. A ferro-cement slab can also be used.

The choice of the superstructure should be left to the house-owner. There are different types in use: bamboo-reinforced mud walls with a thatch roof, bamboo mat side walls with a thatch roof, thatch walls and roof, 110 mm brick walls, etc. The roof can be made of tiles, asbestos, cement sheets, stone slabs, or 50 mm reinforced concrete slabs.

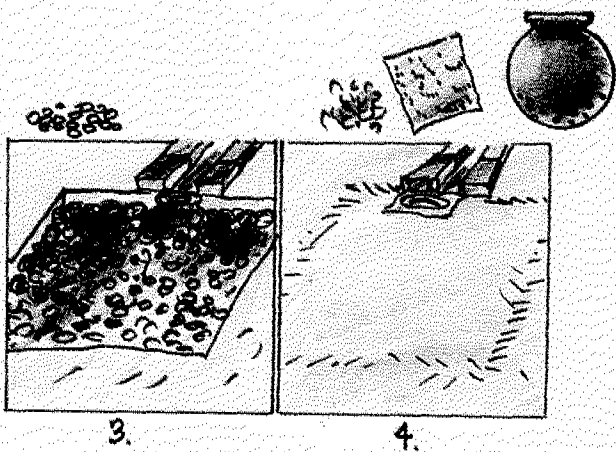
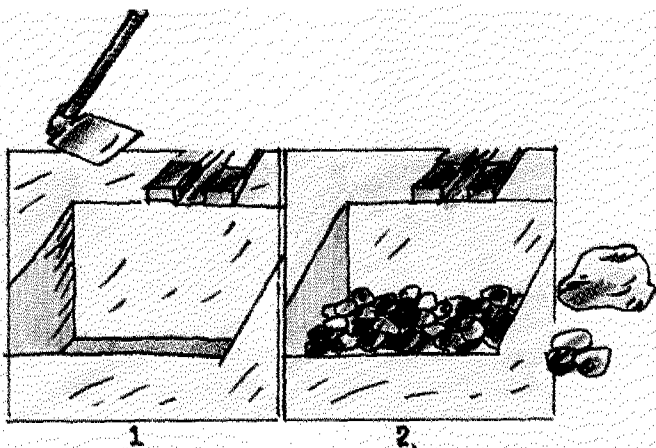

# Disposal Of Waste Water

## **HOW TO CONSTRUCT A SOAKAGE PIT**

- Dig a pit 1 m long, 1 m wide and 1 m deep, at a convenient place so that the drain leading the waste water ends near the pit.
- Fill the pit up to one-third its depth with stones of size 10 to 15 cm in diameter followed by stones 5 to 10 cm in diameter filled up to two-thirds depth.
- Place a 20 cm diameter clay pot with small holes at the bottom, 2 cm in diameter, at the outlet of the drain. Coconut fibre/leaves placed inside the pot trap the sediments. Fill the pit with stones 1 cm in diameter, up to a level of 10 cms below the ground level.
- Place a 5 cm layer of twigs, followed by a gunny cloth on the top layer of stones, keeping the mouth of the pot exposed. Place soil on the top of the gunny cloth and compact it to ground level.
- Waste water will flow through the pot into the pit.

**Note:** When the pit starts spilling, the pot and the stones can be removed, washed, dried and reused. The pit can be cleaned and used once again.

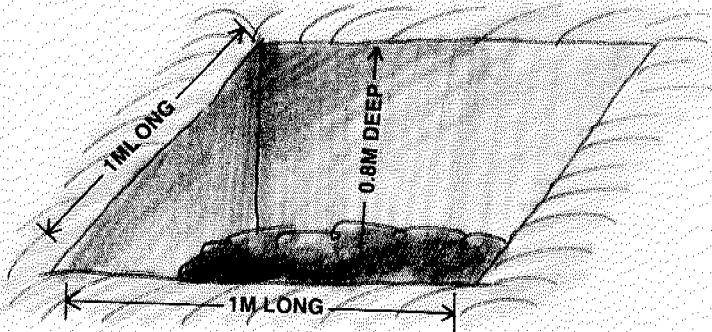

# Disposal Of Garbage And Cattle Dung

## **HOW TO CONSTRUCT A GARBAGE PIT**

- Select a site at some distance away from the house, such as the corner of the backyard.
- Dig a pit 1 m long, 1 m wide and 0.8 m deep.
- Build an earth bank about 10 cm high around the pit and compact it well. This prevents rain water from flowing into the pit.
- Every week, level the contents in the pit with a rake or stick and cover them with a layer of earth and compact to about 3 fingers in thickness. This will prevent flies from breeding in the pit. When full, the pit should be covered with a layer of firm soil and left undisturbed. After two to three months, the contents turn into compost and can be used in the kitchen garden as fertiliser.
- Construct a new pit next to the existing one when the first one is full.

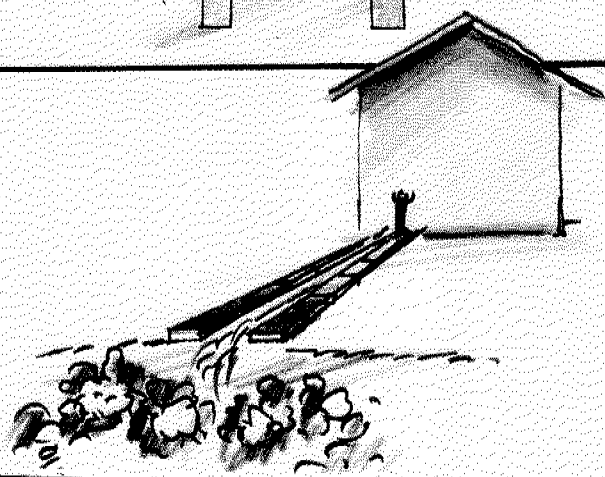
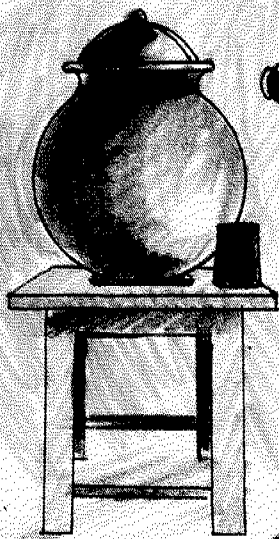

# Checklist For Household Sanitation

While motivating households, gather information on the following as a monitoring exercise for the promotion of sanitation. Report this information to the local sanitary mart or to the elected Panchayat members in your village or to the members of the village Water and Sanitation Committee.

## **Handling Of Drinking Water**

- Is the storage container covered ?
- Is the storage container placed on a raised platform, above the ground level ?
- Is the ladle kept near the storage container and used to take the water out ?
- Is the water stored in a long-necked *surahi*, if the ladle is not being used ?

## **Disposal Of Waste Water**

- Is the household waste water being channeled into a soakage pit, natural drain or into a kitchen garden ?
- Is the soakage pit built per design ? Is it spilling over ?



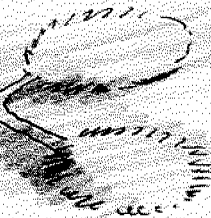
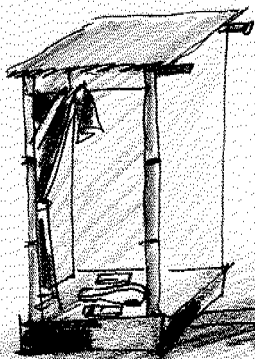
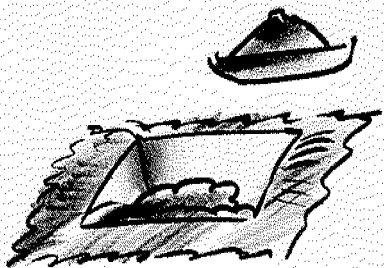

### **Disposal Of Garbage And Cattle Dung**

- Has the household constructed a garbage pit ?
- Is the household using the compost from the garbage pit as fertiliser ?
- Is the cattle dung being disposed off in the garbage pit ?

### **Disposal Of Human Excreta**

- Is the latrine constructed a sanitary one ? Single-pit pour flush latrine, two-pit pour flush latrine or any other design ?
- If yes, is a water pitcher kept outside ?
- Is soap or ash kept outside the latrine to wash hands with after defecation along with a bucket/mug to flush the latrine ?
- Is the superstructure complete ?
- Does the latrine show signs of being used ?
- Are the female members/children of the household using the latrine ?
- Is children's/infants' excreta disposed off in a latrine ?
- Do the household members know the address of the mason, so that they can speak to him if the latrine is not functioning properly ?

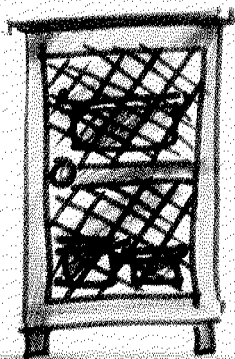
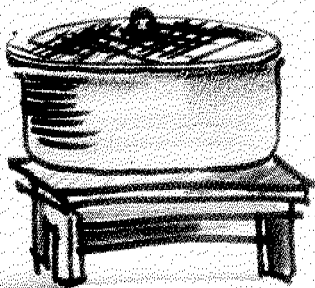

**Home Sanitation And Food Hygiene**

- Is the house well ventilated and generally kept clean ?
- Is the cooked food kept covered and stored in a food safe ?
- Is the house kept free of smoke by using a smokeless *chulha* ?

**Personal Hygiene**

- Does the household use soap/ash regularly for bathing/washing hands ?