Technical Note Series

School and Anganwadi Toilet Designs

Norms and Options



सत्यमेव जयते

**Department of Drinking Water Supply
Ministry of Rural Development
Government of India**

Table of Contents

	Page No.
1. Foreword.....	i
2. Preface.....	ii
3. School and Anganwadi Toilet Design- Norms and Options.....	1
a) Introduction.....	1
b) School and Anganwadi Toilet Facilities- Some Issues and Solutions.....	2
• Location of the toilet facilities.....	2
• Children especially girls and disabled friendly toilets.....	3
• Toilet Technologies and Design Options.....	7
• Environmental Factors.....	9
• Indicative Design Options-some norms.....	11
• Anganwadi Toilet Design Option.....	12
• School Toilet Design Options.....	13
• Why Rural Pan.....	27
• Ratio of urinals and toilets.....	28
• Use and maintenance of the school water and sanitation facilities.....	29
c) Summary.....	32
4. Annexures	
• Annexure 1	
• Annexure 2	
• Annexure 3	
• Annexure 4	
• Annexure 5	



PALAT MOHANDAS
SECRETARY

भारत सरकार
ग्रामीण विकास मंत्रालय
पेय जल आपूर्ति विभाग
Government of India
Ministry of Rural Development
Department of Drinking Water Supply
247, 'A' Wing, Nirman Bhawan, New Delhi-110011
Tel. : 23010207, 23010245, Fax : 23012715
E-mail : secydws@nb.nic.in

FOREWORD

School Sanitation and Hygiene Education (SSHE) is one of the most important components of the Total Sanitation Campaign (TSC) launched in the country. By introducing the SSHE in the Anganwadis and Schools, we intend to "catch them young". Also, children are identified as the best change agents. It is amply demonstrated that they can play an effective role in creating a clean and healthy environment not only in the schools, but also in their community. Schools and Anganwadis are the ideal centers to make them learn the importance of health and hygiene, and necessary sanitation facilities should be made available in the Anganwadis and Schools.

The success of TSC, to a great extent, depends upon the success of the SSHE programme. Successive generations, beginning with the present, have to be introduced to the best sanitary and hygiene practices right at the childhood. Providing necessary and quality sanitation facilities in the schools is the first step in this direction.

There was an urgent need to develop a Technical Manual on the design options for the Anganwadis and Schools, to suit the special requirements of babies and children. The Manual tries to address the major issues relating to child-friendly design options, in a comprehensive manner. This is a first attempt of its kind, and it is hoped that those concerned with the implementation of the Anganwadi and School Sanitation programme should find it extremely useful.

(Palat Mohandas)

New Delhi
15 January 2004



राकेश बिहारी
संयुक्त सचिव
RAKESH BEHARI
Joint Secretary

सायपेव जयते

भारत सरकार
पेयजल आपूर्ति विभाग
(राजीव गांधी राष्ट्रीय पेयजल मिशन)
Government of India
Department of Drinking Water Supply
(Rajiv Gandhi National Drinking Water Mission)

PREFACE

Coverage of School and Anganwadi sanitation is abysmally low in rural areas. Sanitation facilities, wherever available, are generally unclean, poorly maintained and after not adopted to the needs of children, in particular girls. School and Anganwadi Sanitation has been given due importance in Total Sanitation Campaign (TSC). TSC is now actively focusing on school sanitation in the light of Government's goal to cover all schools with toilet facilities by 2005-2006, with emphasis on separate toilet blocks for girls in all co-education schools. Government also plan to cover all Anganwadis with toilet facilities. Meeting these goals will be critical for improvement of health, education and all round development of children. Keeping this in mind, this technical note has been prepared with some indicative design options and norms to be followed during pre-construction, construction and post construction period of School and Anganwadi toilets.

We are thankful to Ms. P. Amudha and Ms. Sumita Ganguly of UNICEF and Shri Eshwarbhai Patel, Environment Sanitation Institute, Ahmedabad for their valuable contribution in development of this technical note. I hope this technical note on school and toilet designs will be helpful to those concerned with the subject.

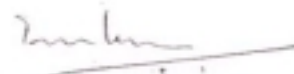
(Rakesh Behari)

New Delhi
January 15, 2004.

School and Anganwadi Toilet Designs Norms and Options

Introduction

The children of today will be the adults of tomorrow. By focusing on children today and by giving them tools and knowledge to change behaviour, future generations can be stronger, healthier and more prosperous. Schools, being the ideal setting for promoting learning, stimulate positive change among children and subsequently, in turn, the community. Schools and in particular Anganwadis are equally important places to address the health issues of the children provided that necessary infrastructure is available. Improved health and quality learning are not possible in schools and Anganwadis as long as basic hygiene is lacking or sanitary facilities and water supply are missing or broken or not properly used. Lack of healthy environment is already resulting in high infant mortality and under five-mortality rate.

There are approx. 6 lakh Anganwadi Centers in India and most of them are without toilet facilities. These Anganwadi Centers reach out to 12.5 million children. In addition, There are about 6.3 lakh rural schools both primary and upper primary with 8 crore school going children (Education Survey, 1993-94, MoHRD-GOI). As per the NFHS-II, 1998, 75 percent of the children in the age group of 6-14 are attending schools in rural areas. But it is also a fact that only 8 percent of schools have the sanitation facilities in the school premises. Out of 6.3 lakh primary and upper primary rural schools, only 44 percent have water supply facilities, 19 percent have urinals and 8 percent have lavatory facilities. Only 19 percent have separate urinals and 4 percent lavatory facility for girls.

School water & sanitation facilities and current scenario

- Non-existent, broken, or insufficient water supply, sanitation and washing facilities
- Toilets or latrines not adapted to the needs of the children in particular girls.
- Children with poor hygiene and hand washing practices
- Non-existent and irrelevant hygiene education for children
- Improper operation and maintenance of the existing facilities

Such conditions result in high absenteeism and low enrolment. These issues are particularly important for girls. Studies show that not having access to proper, safe and private sanitation substantially increases absenteeism among girl learners, and

contribute to their dropping out of schools altogether. This is evident from high drop out rate in particular girls, for example, only 42 percent of the girls reach class VIII as reported by Indian Child, MoHRD- 2002.

Thus, the toilet facilities in every school are very essential for the improvement of health and education development of the children. Realizing this, the Govt. of India has already planned to cover all the Govt. Rural Schools by 2005-06 by providing water and toilet facilities with special provision to construct separate toilet blocks for girls in all-co educational schools. Govt. has also planned to cover all the Anganwadis with toilet facilities.

School/Anganwadi Toilet Facilities and Some Issues

As evident from above, toilets in Schools and Anganwadis are necessary for the healthy growth of the children but there are issues, for instance, of **privacy, safety, dignity, cost, child friendly designs, etc**, which need to be addressed and solved before providing sanitation facilities in schools. At the same time, some norms are to be followed both in the selection of toilet designs, location and construction of the toilets. Some of the issues are discussed below with possible solutions:

1. Where should the toilet site be located and what norms to be followed?

Location of the site of toilet is very important for its effective and proper use. The following issues must be considered when choosing a location for hygiene and sanitation facilities:

- **Safety:** Children must feel 'safe' when going to visit the facilities without having fears and risks for harassment and attacks by animals (such as snakes) or people. Access routes must be open and clear, without long grass and bushes. The facilities must also be at hearing distance and/or have visual contact with the school to get assistance, if needed.

Goal

- To cover all rural schools by providing water, sanitation and hand washing by 2005-06
- To cover all Anganwadis with toilet facilities
- Separate toilet facilities for girls in co-ed schools
- To ensure proper O&M of the facilities created
- To impart hygiene education to children

Location Norms for Toilets

- Safety of the user
- Privacy especially of the girls
- Accessibility for the effective use
- Location should be environmental friendly
- Supervision for the proper use
- Location of the sanitation facilities should not contaminate the ground water

- **Supervision:** Somebody has to be responsible for overseeing proper use of the facilities (including outside school hours and during holidays).
- **Privacy:** Facilities must offer privacy when entering and using the sanitation services especially for the girls.
- **Environmental degradation:** Hygiene and sanitation facilities are often brought together with other 'unwanted' activities, such as waste collection which causes nuisance, such as bad smell, flies and other pests. This will de- motivate people to use the facilities.
- **Risk of groundwater contamination:** Facilities have to be located at a safe distance especially from water sources to avoid the groundwater contamination.
- **Accessibility:** it must be possible to reach facilities at all times and in all weather conditions especially heavy rains.

2. How should a child especially girl child and disabled friendly design options be selected?

It is very important to select appropriate and child friendly design especially for girls and disabled both at School and Anganwadi. Though, it is impossible to give right standards for dimensions of hygiene and sanitation facilities at schools because height and proportions of children vary considerably in different regions. In fact, hygiene and sanitation facilities should be very gender specific as girls have other physical and sometimes cultural needs than men and boys, hence, demanding different solutions. For example, less number of urinals can be provided for boys as the time taken for girl for one use of urinal /toilet is more than that for boy, which

means more urinals and toilets are needed for girls than boys for same strength of students. Similarly, special facilities for menstrual hygiene must be provided for girls in toilet complex in schools.

Gender divisions of responsibilities during design, construction, operation and maintenance including decision-making should be considered. However, following dimensions can be still determined while selecting appropriate toilet design:

Important Considerations

- Presence of latrines and ratio of latrines for boys and girls
- Cleanliness of the latrines and presence of cleaning materials especially hand washing material
- Drainage of wastewater
- Garbage disposal
- Accessibility of the latrines for the entire school population
- Appropriateness of the design

- **Height of seats.**
- **Height of urinals.**
- **Height of hand-washing facilities (taps, soap, etc. are reachable?).**
- **Distance between the footrests of squatting platforms.**

Norms for the Child, Gender and Disabled friendly Toilet

- Access to toilet must be open and clear without any hindrance
- If the toilet for boys and girls are in one complex, they should have separate entrances preferably on opposite sides to avoid inconvenience and ensure privacy.
- There should be hooks for hanging duppattas for girls (see annexure 3 photo 6).
- Factors like lighting, ventilation, provision of doors with system of latching, etc also need to be taken into account.
- The superstructure should be such that students feel safe and comfortable using toilets.
- Hand washing space should be located at the most convenient place.
- Availability of water and other cleaning material such as brush, phenyl, mug, soap must be secured.
- Toilet designs should also cater to the needs of **disabled children** with simple adaptations such as :
 - Low level of hand rail in toilet.
 - Ramps, in case the toilet is at higher level or raised stool in case of Indian pan (see annexure 1). Steps should be avoided as far as possible.
 - A pipe to be attached to the tap for self-cleanings (as the child will be holding the bar/ hand -rail for balance).

Furthermore, it must be recognized that children of different ages have also different physical strength and motor skills, requiring sometimes-special solutions. Following aspects must also be considered and measured:

- **Height of doorknobs and locks.**
- **Height of steps and handrails of stairs.**
- **Weight of the doors.**
- **Strength needed to open taps, fetch water, etc.**
- **Diameter of the squatting hole (needs oftentimes also psychological considerations because of fear of falling through)**

Although, it is not possible to set any standard dimensions for children for every school, due to major regional variation in size certain basic guidelines (ranges) can be developed for application in most such toilet facilities. The samples of Anthropometric Toilet Design Data can be seen below for the hand washing and urinal which may help Programme Managers/Engineers to set some standard dimensions in Schools and Anganwadi where sanitation facilities are planned to be provided.

Figure 1, Part 1

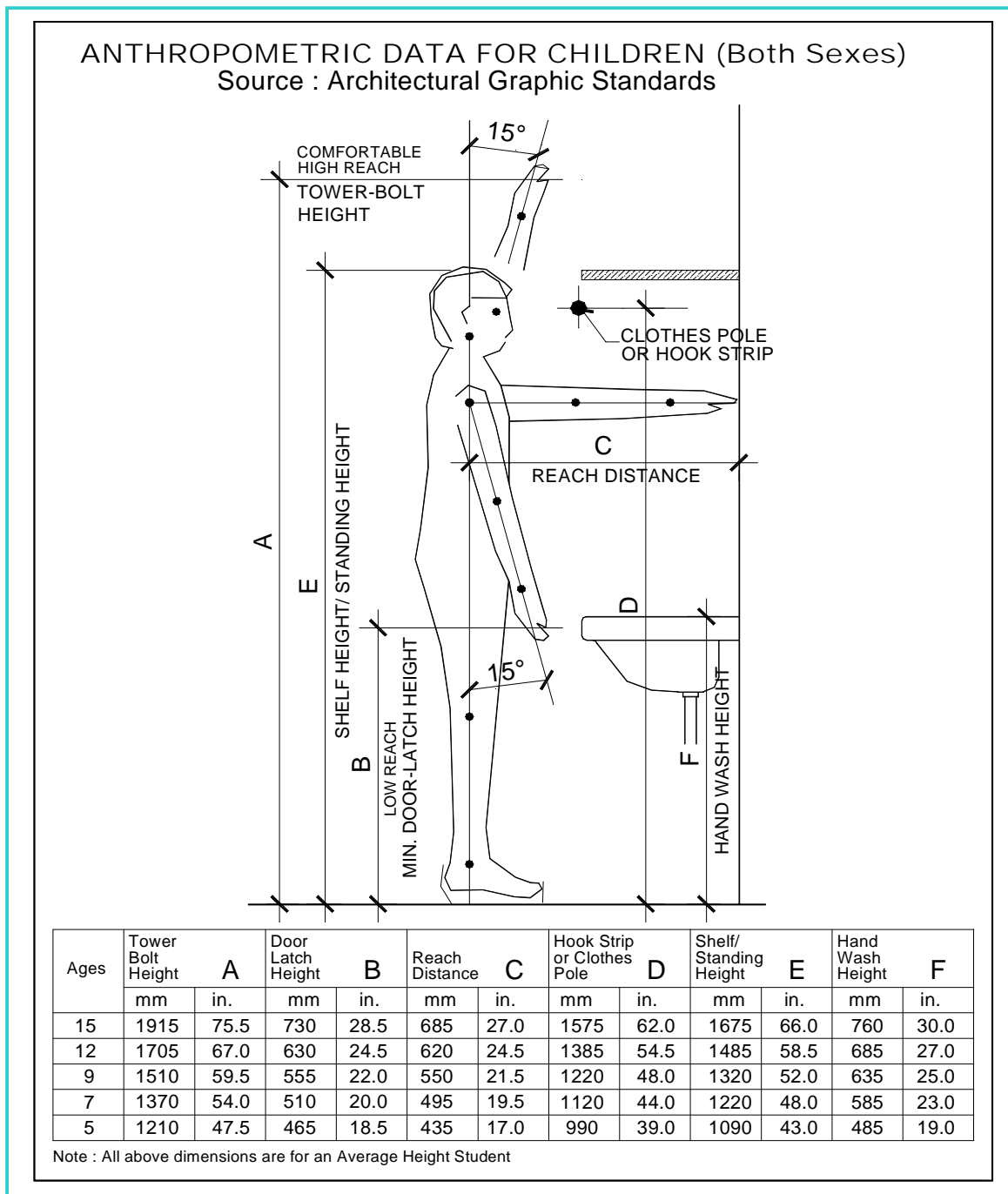
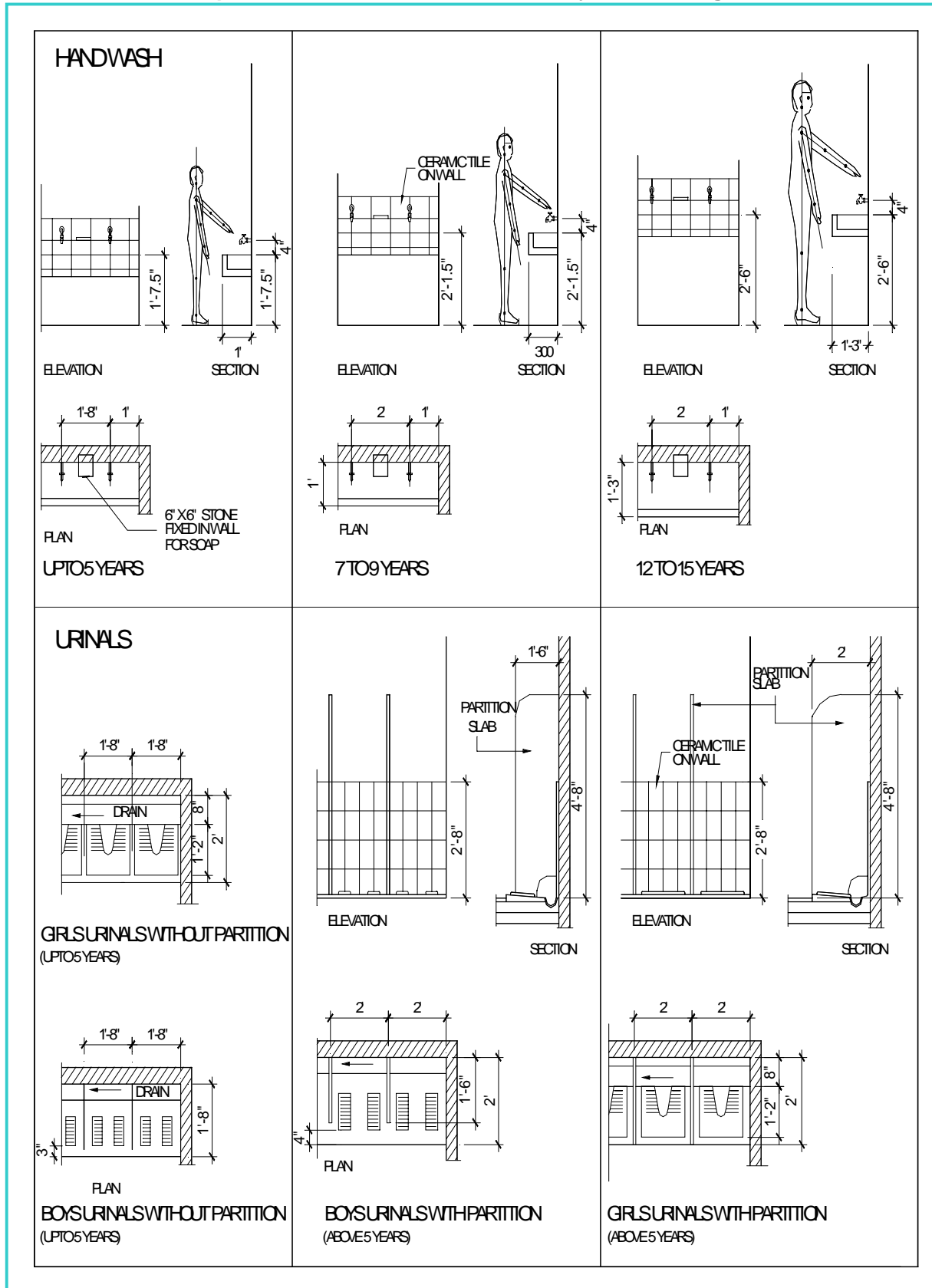

Figure 2, Part 2

Anthropometric Data for Children-friendly Toilet Design



3. What are the toilet technologies and design options?

Before selecting a design option, it is necessary to know that toilet complex **must consist of urinal, latrine, junction chamber, water tank, hand washing for instance, wash basin or washing place, drainage system for urine and pit.** The technologies promoted for the construction of the toilet are given below:

- **Pour flush toilet with single or two (lined or unlined) pit with rural pan** Under this technology, the water and gas of the excreta gets absorbed through the pores of the leach pit and solid gets decomposed into manure. It is a desirable technology where contents of the pit are not visible due to water seal. It needs water for flushing but with the use of rural pan the consumption of the can be minimized.
- **Ventilated improved pit latrine (VIP):** VIP is more suitable for water scarce area where people do not use water for flushing. In this technology, solid excreta directly gets deposited in the pit and gas get evaporated through pipe as shown in the figure 2.

Important Considerations

- No septic tank, only leach pit and preferably two pit system for schools
- Use of rural pan
- Usually pour flush latrines and VIP latrines (only in water scarce area)
- Water, lavatory, urinal, hand washing, drainage and garbage pit facilities in schools

Pour flush Water Seal Latrine- Figure 3

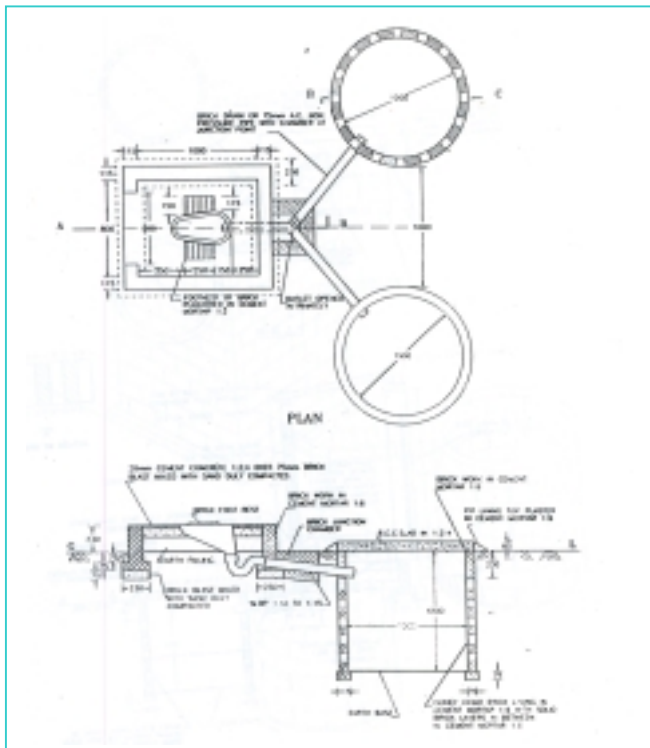

Ventilated Improved Pit Latrine(VIP) Figure 4

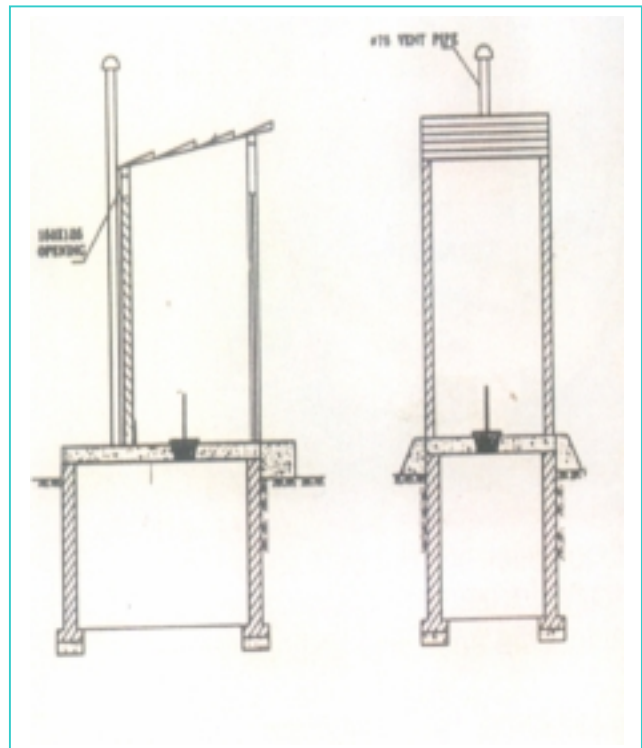

Some technological options are also available for **water logged and sub soil areas** within the leach pit pour flush toilet model, which can be understood from the below designs:

Figure 4

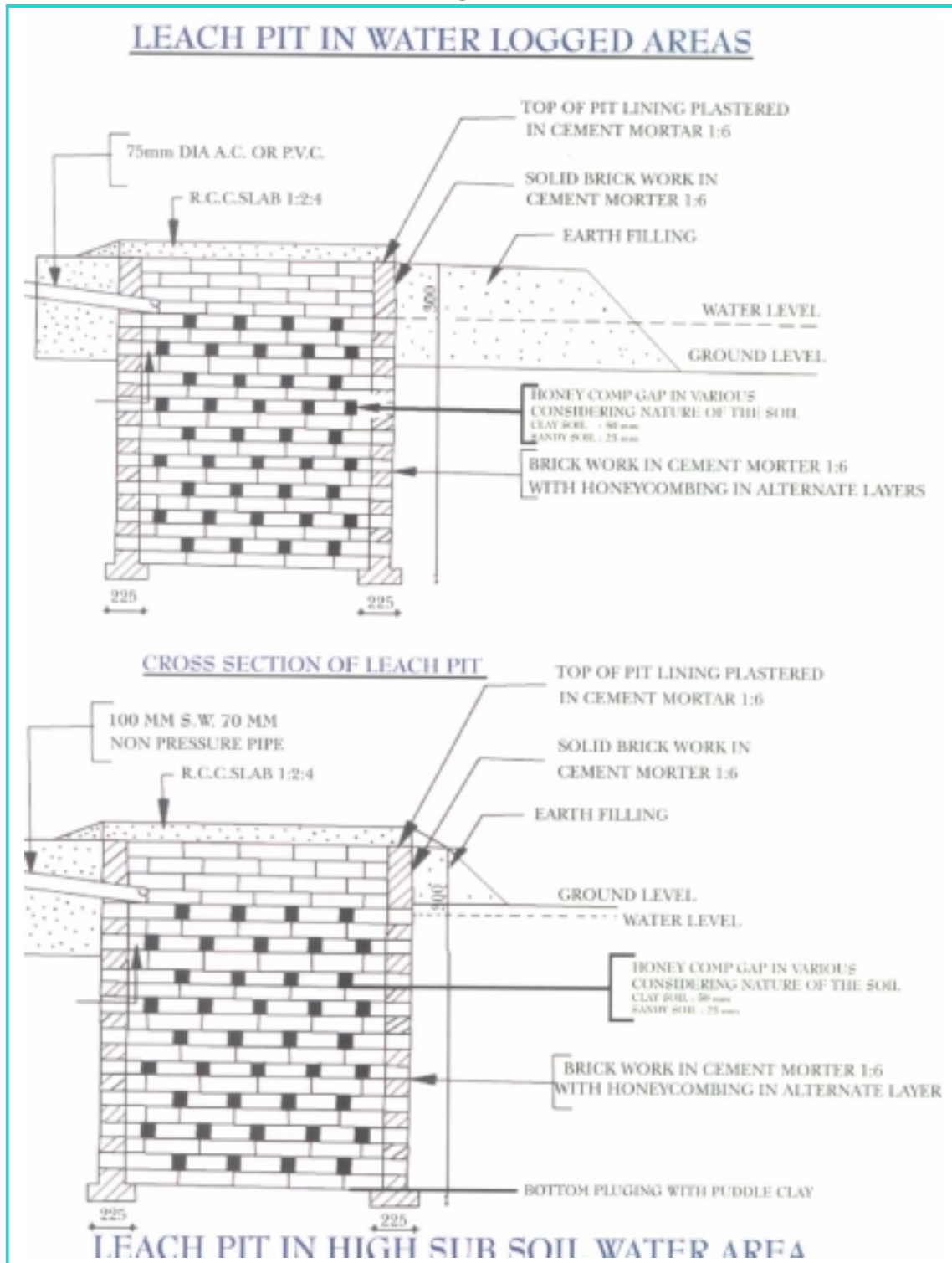

Environmental factors

There are different environmental factors, which play important role in deciding on the type of technology for the construction of the latrines, which need to be considered.

Some of the considerations are depicted below in table 1:

Table 1

Specific topic on which information/data is needed	Considerations
<ul style="list-style-type: none"> • Type of soil-stability 	
Loose, sides of wall collapse	Line the pits. In very sandy soils, sink cement rings that are perforated or set on top of each other without cement.
Hard to dig	Use the pour flush design rather than VIP, as the pits are less deep.
<ul style="list-style-type: none"> • Permeability (how water is absorbed by soil) 	
Clay soil	Test by pouring water into a hole and measuring how long it takes to be absorbed. Pits in dense clay may need back filling about 1.2 meters with more sandy soil.
Coarse sand	Back fill around the rings with denser soil and/or locate the latrine pipes far (for example, 40 meters or more) from a well used for drinking.
Hard laterite	If there might be cracks in the laterite, the latrine pits can pollute nearby drinking water sources. Place the latrine far from these sources
<ul style="list-style-type: none"> • Ground water level in wet season (deepest level) 	
Water rises higher than one meter from bottom of the latrine pit, but never completely floods the latrine pits	Locate the latrine pit far from any well used for drinking purpose and should be away for example, 40 meters or more
Water rises to or above the ground level and sludge comes out the latrines	Raise the latrines above the ground level so that the top third of the pit is always above the water level. Place latrines far from drinking water sources.
<ul style="list-style-type: none"> • Distance to water sources 	
Distance from latrines pit to drinking water sources	At least 15 meters
Children or teachers may be spent extra time, for example, more than 15 minutes going one-way to collect water	VIP latrine is preferred as it uses less water.

Similarly, there are some soil and water availability related issues, which need to be considered while selecting the appropriate toilet option. Below table can help implementers in this regard.

Table 2

Different latrine types

Latrine type	Suitable for high ground water table	Suitable for areas prone to floods, tidal floods or flushes	Suitable for loose soils	Suitable for soils of low permeability	Water requirement	Ease of construction	Ease of maintenance	Remarks
Direct single pit latrine without pour-flush	Yes, if raised	Yes, if raised	Yes, if fully lined	Not for clay soils	No	Easy	Easy	Sludge unsafe
Direct double pit latrine without pour-flush	Yes, if raised	Yes, if raised	Yes, if fully lined	Not for clay soils	No	Easy	Easy	Safe sludge
Offset single pit latrine with pour-flush	Yes, if raised and with soak away	Yes, if raised	Yes, if fully lined	Yes, with soak away	Yes	Easy	Easy	Sludge unsafe
Offset double pit latrine with pour-flush	Yes, if raised and with soak away	Yes, if raised	Yes, if fully lined	Yes, with soak away	Yes	Fairly easy	Easy	Safe sludge
Solar heated single-vault ecological latrine with urine separation	Yes	Yes	Yes	Yes	No	Easy	Difficult	Safe dehydrated material
Double-vault ecological latrine with urine separation	Yes	Yes	Yes	Yes	No	Easy	Difficult	Safe dehydrated material
Unslat	Yes	Yes, if raised	Yes	Yes	Yes, a bit	Easy	Easy	

Source: IRC Technical Paper Series 39 [School Sanitation and Hygiene Education – India]

Indicative Design Options

Keeping these technological options in mind, several indicative design options for Anganwadis and schools have been developed. Though, ideally active involvement of the users is essential not only during assessment but also during the design process. Whole design process will be a participatory learning experience when children, teachers, parents and community members are given the opportunity to determine their own needs, discuss possible solutions and set up operations and management systems. Indeed, there are some norms related to cost, design and construction, which need to be adhered as given in the below box.

Norms on cost, design and construction

- The average cost per toilet block should not exceed the limit of Rs. 20,000/- as per the TSC guidelines. If it exceeds, that may be met by the State Govt./District /PTA/PRIs.
- For co-ed schools, separate toilets for girls and boys should be constructed (see the difference of urinal for boys and girls in annexure2).
- **No septic tank but leach pit should be used.**
- The site selected for the toilet complex and leach pits should be kept at a distance more than 10.0 meters from the drinking water well or the hand pump of the school or Anganwadi.
- Corner of the compound may be used to reduce the cost of the construction.
- The land should be able to absorb water so that waste water collected in the leach pit gets easily absorbed in the ground.
- Locally available material should be used as far as possible
- The no. of urinal or latrines should be in conformity with no. of boys and girls of the respective schools.
- Design should be locally acceptable and child friendly. It must be easy to use.
- Day lighting and ventilation of the facilities as well as fly control are also important aspects towards ensuring hygienic behavior.
- Hygiene and sanitation facilities must be simple enough to maintain, and facilities for hand washing and anal cleansing must be well designed, well placed and integrated into the entire package of facilities.
- Provision of sufficient water should be made for cleaning and hand washing.
- Necessary consumables like soap, cleaning powder, etc. to be replenished regularly
- Rural pan should be preferred as it consumes less of water and is cheap.
- Inside surfaces should be kept smooth.
- It is necessary to provide 2.5 to 5.0 cm size holes in the masonry of the soak-pit at the time of construction, so that water and gas collected get absorbed into the soil.
- Roofing over the urinal is desirable. The roof can be corrugated sheets, plastics or tiles. Roof will ensure protection against rain and sun. The roof should slope outwards.
- All surplus material after construction is to be removed and the site be cleared and dressed.

A. Design Option for Anganwadi

The below design for Anganwadi option is estimated at Rs 5,000 approximately. Though with use of GI sheet for roofing and AC sheet for wall cost can further be reduced.

Anganwadi Toilet Design Option 1- Part A

Figure 6-Plan and Cross Section of the Anganwadi Toilet

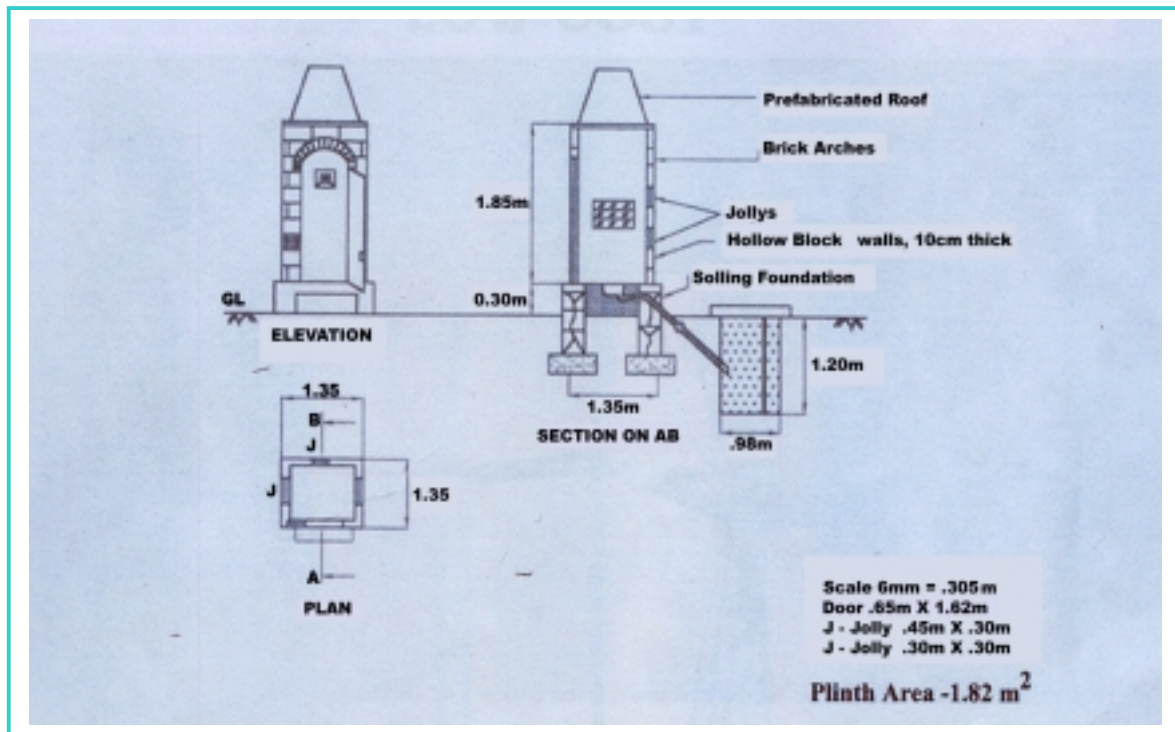

Anganwadi Toilet Design Option 1- Part B

Figure 7-Photograph of the Design

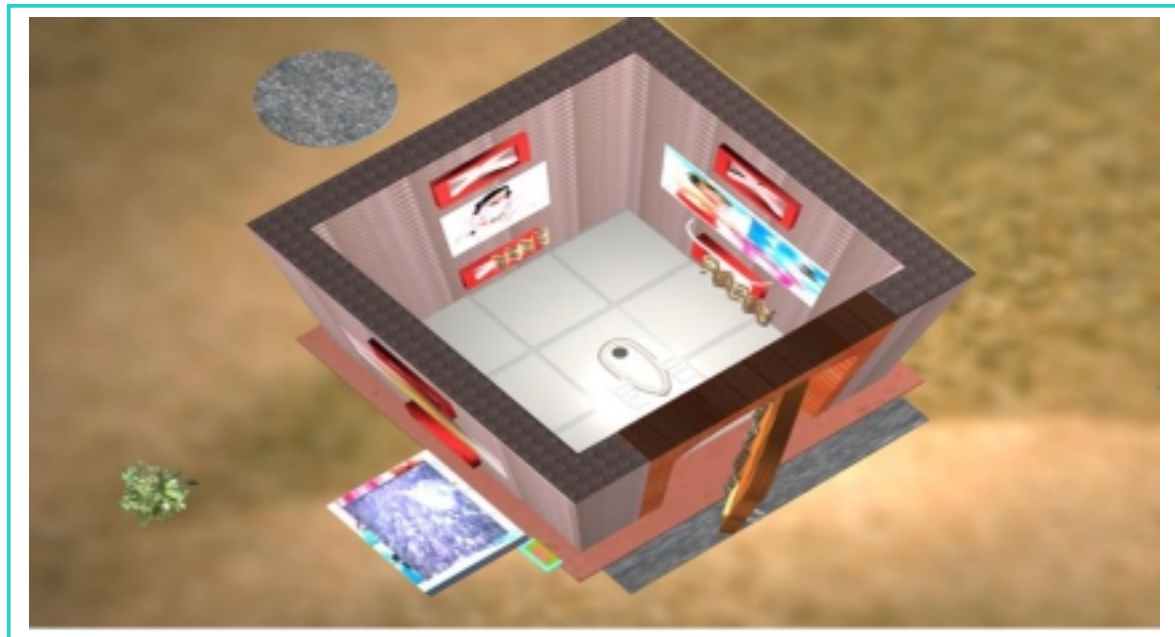

B. Design Options for the schools

Some of the design options have been worked for the schools for different levels such as primary and upper primary and for boys and girl. It should be noted that prototype designs are workable only up to a point; site-specific modifications need to be carried out to site users convenience and preferences. The exact costing should be carried out by each district as per the local rate and availability of the materials.

- **School Toilet Design Option 1**

This design options is for 150 students and can be constructed in primary and upper schools.

School Sanitary Complex Design Option-1- Part 1

Figure 8- Plan for Urinal and Lavatory for 150 students (especially for girls)

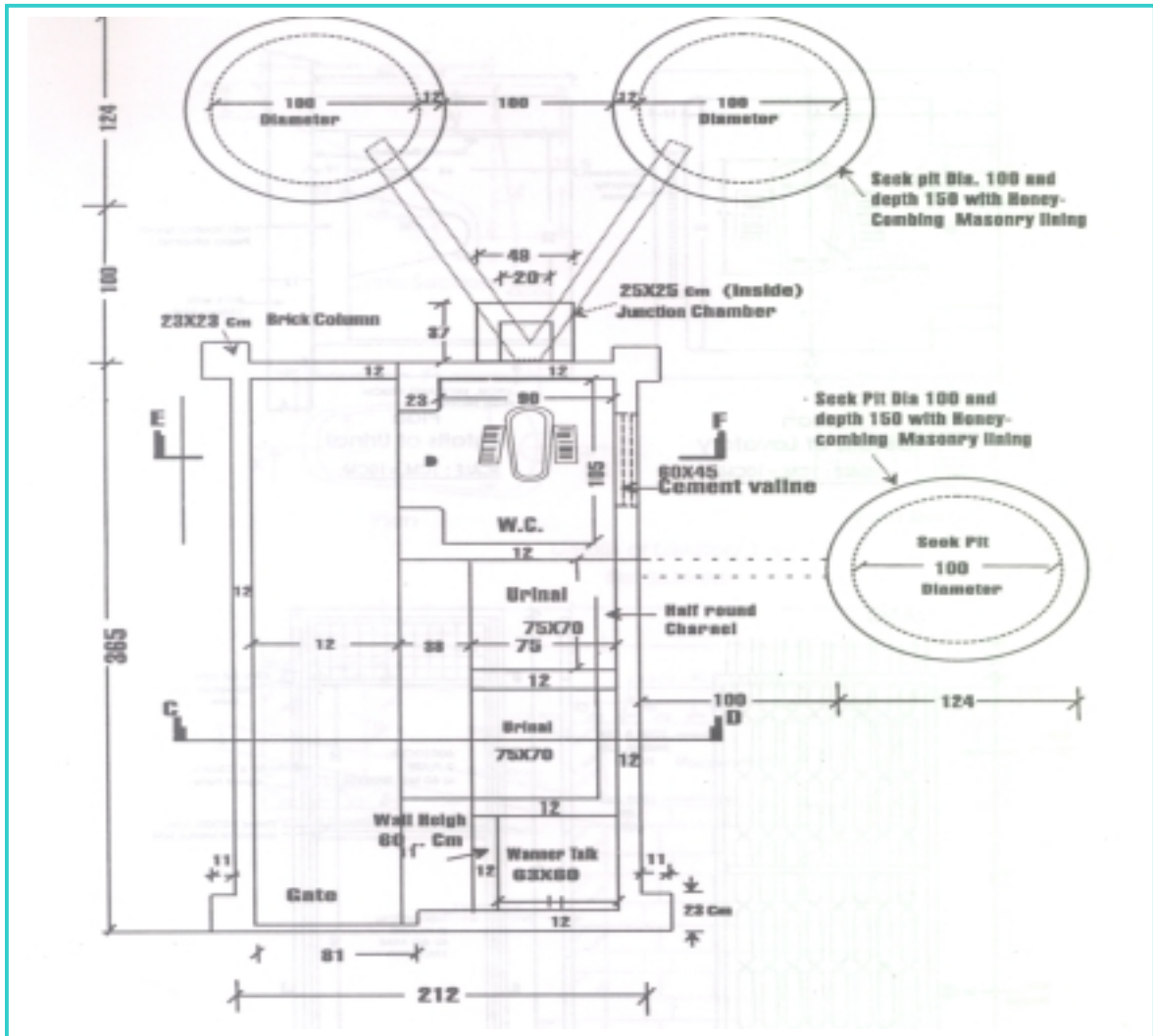

School Toilet Design Option 1, Part-2
Figure-9 Foundation Plan

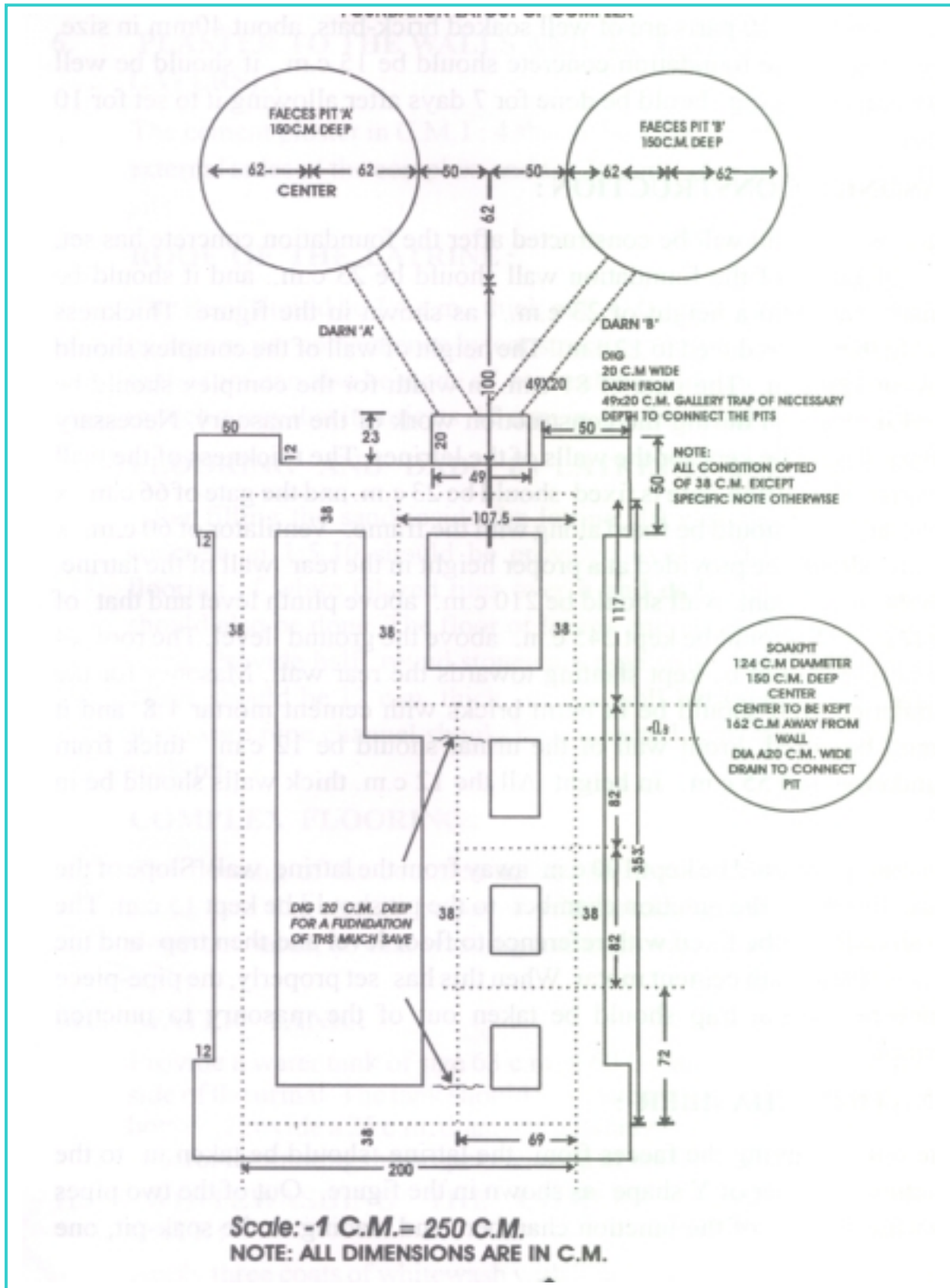

School Toilet Design Option 1, Part -3

Figure 10- Detail Plan of urinal, lavatory and gate

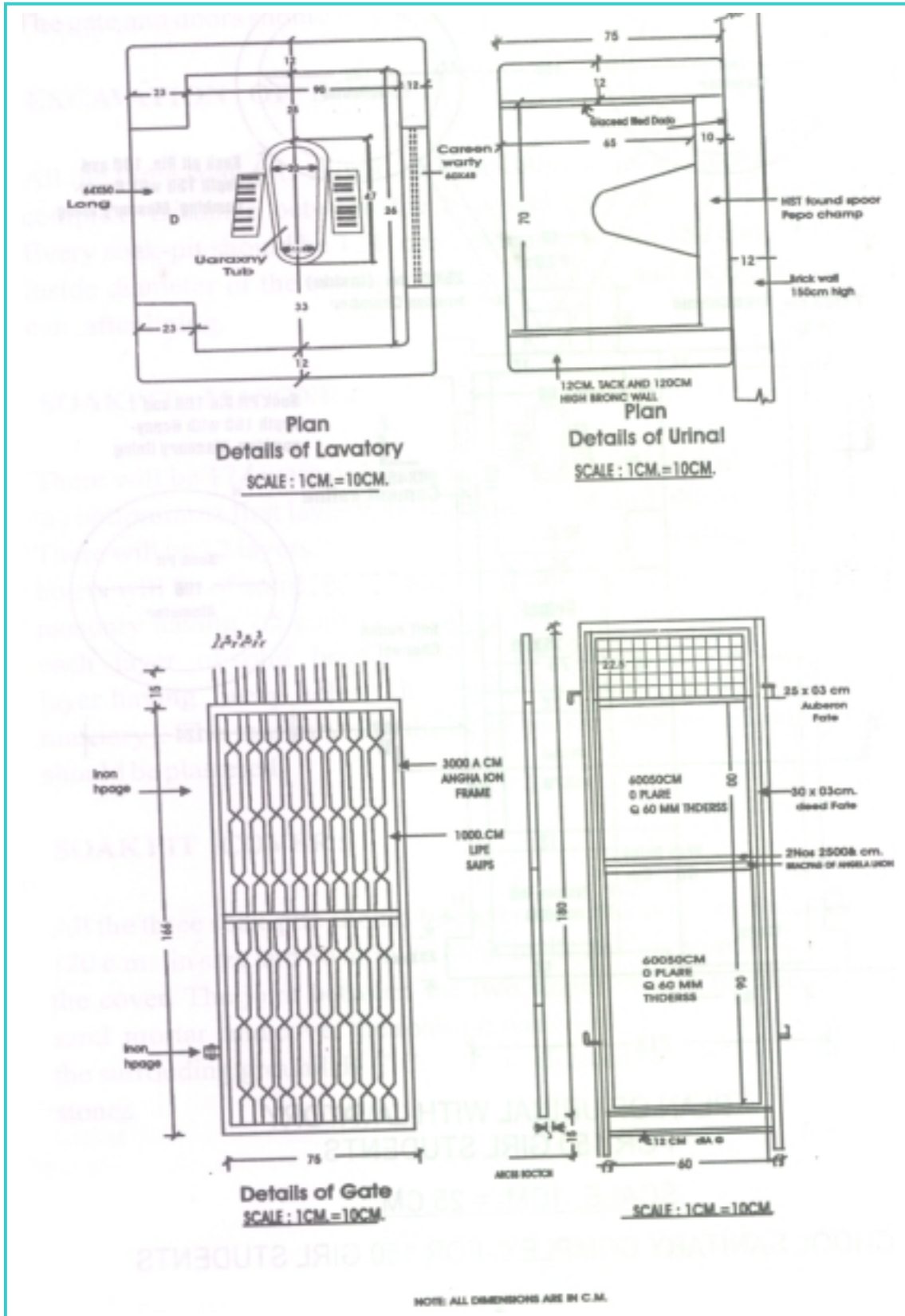

School Toilet Design Option 1, Part 4

Figure-11 Detail Plan of Pan and Lavatory Tube

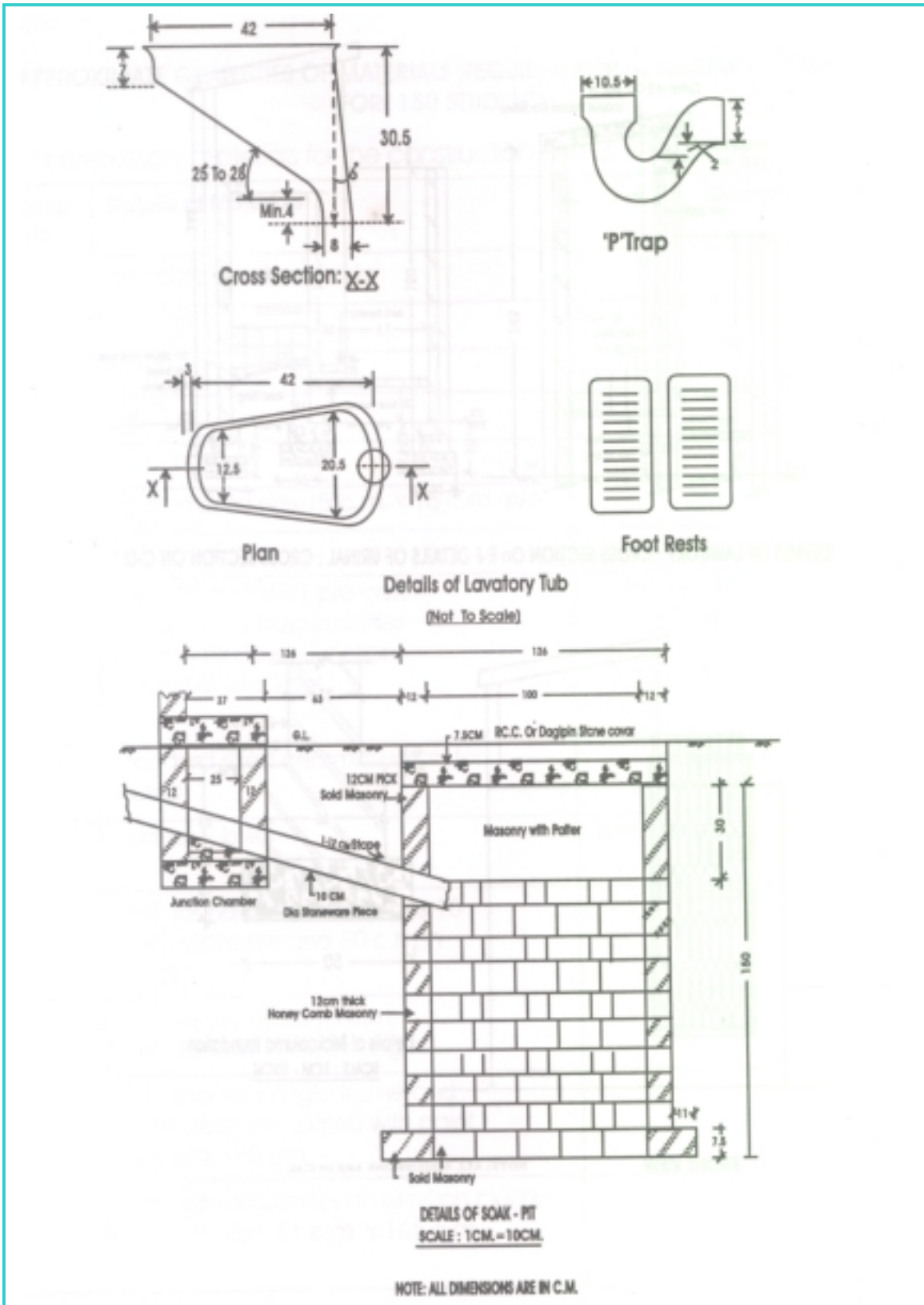

School Toilet Design Option 1, Part 5
 Figure 12- Detail cross-section plan

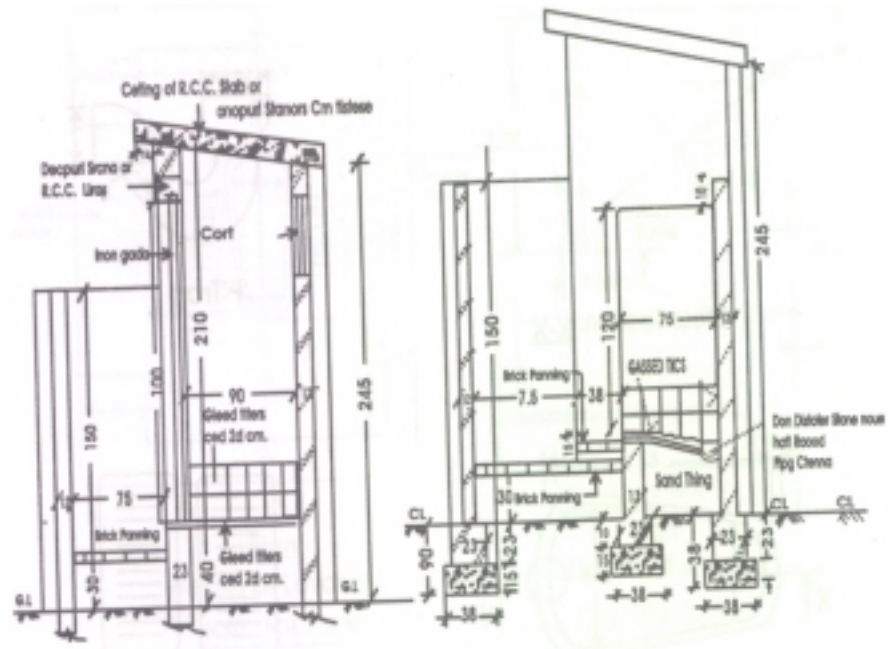

DETAILS OF LAVATORY : CROSS SECTION On E-F DETAILS OF URINAL : CROSS SECTION ON C-D

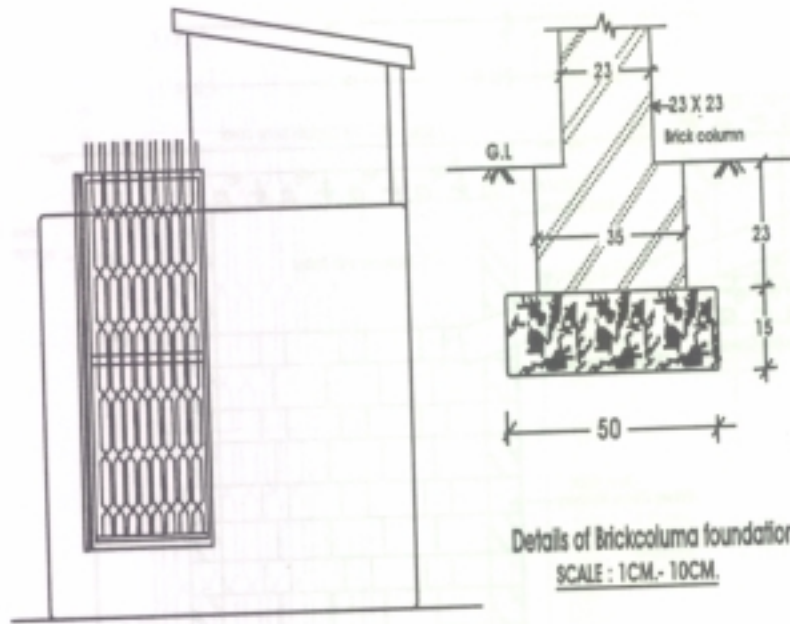

FRONT VIEW

NOTE: ALL DIMENSIONS ARE IN C.M.

- **School Toilet Design Option 2**

The below design option is for 200 students and estimated at Rs. 20,000 approximately. This can be constructed in middle level schools especially for girls.

School Toilet Design Option 2- Part 1

Figure 13- Plan and Cross Section

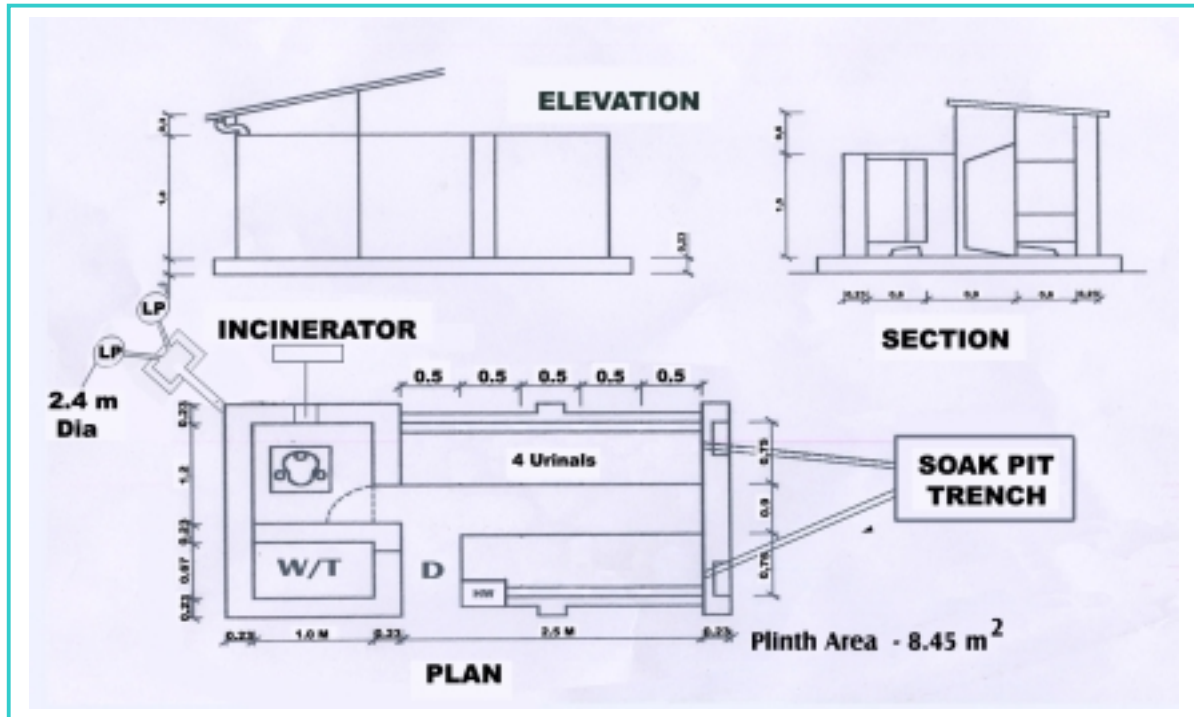

Part 2

Figure 14- Photograph of the plan

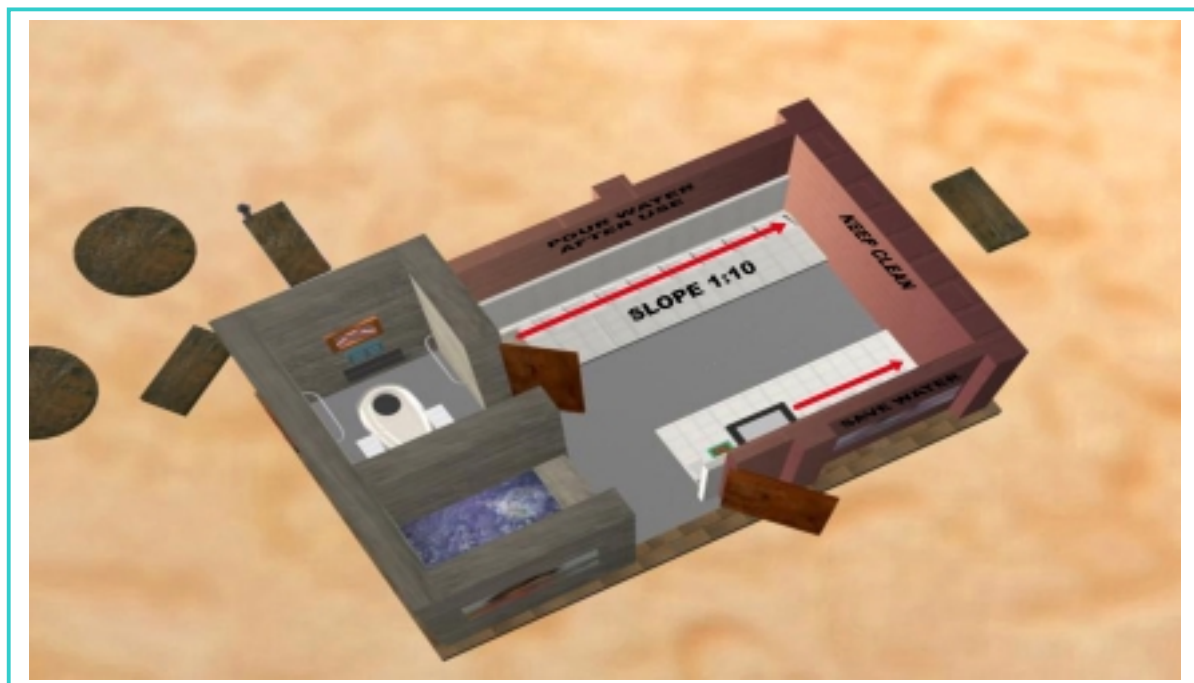

- **School Toilet Design Option 3**

This design option is for 250 students both for boys and girls and estimated at approx. Rs. 20,000.

School Sanitary Design Option-3

Figure 15- Plan for boys and girls- Type-1

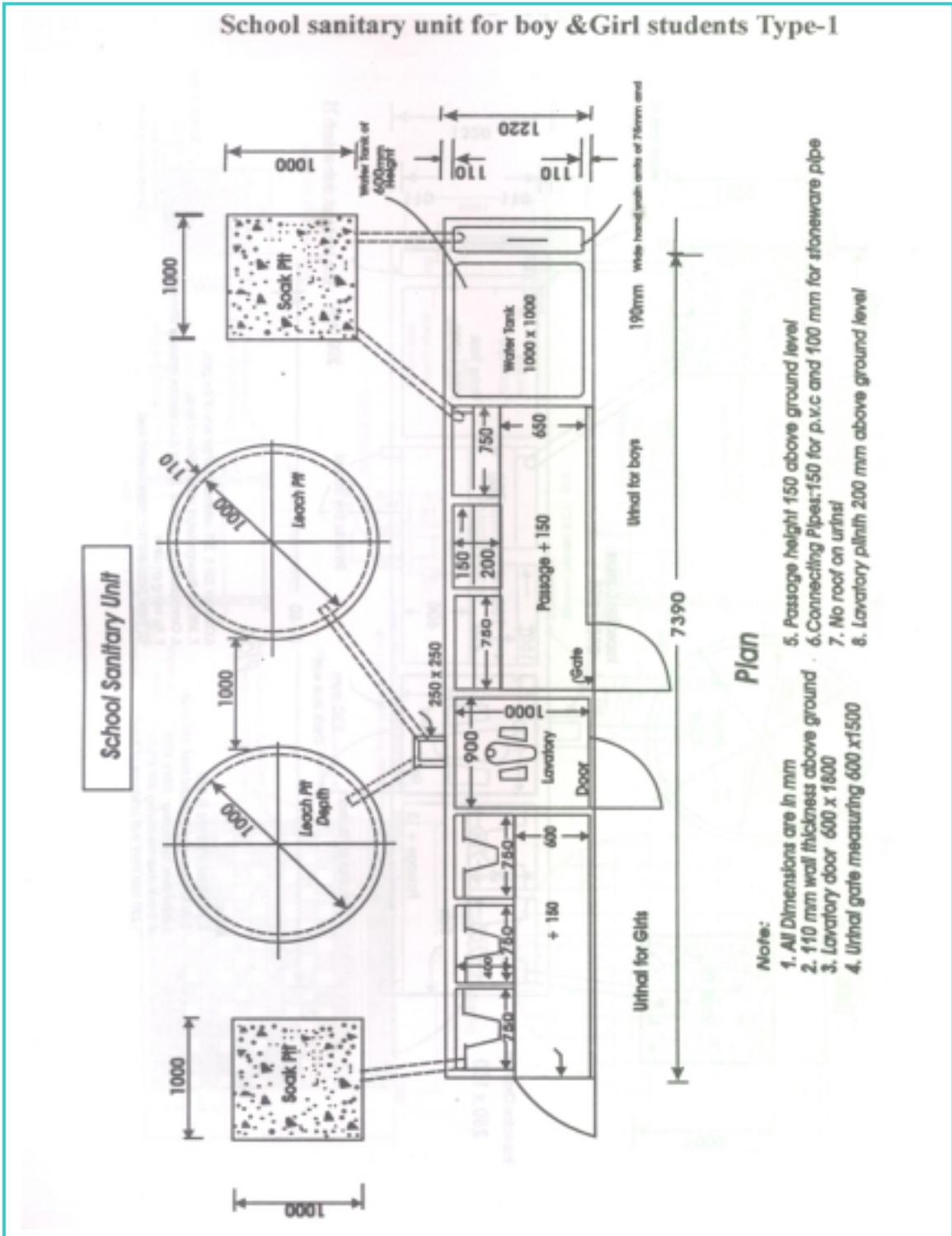

School Sanitary Design Option-3

Figure 16- Plan - Type-2

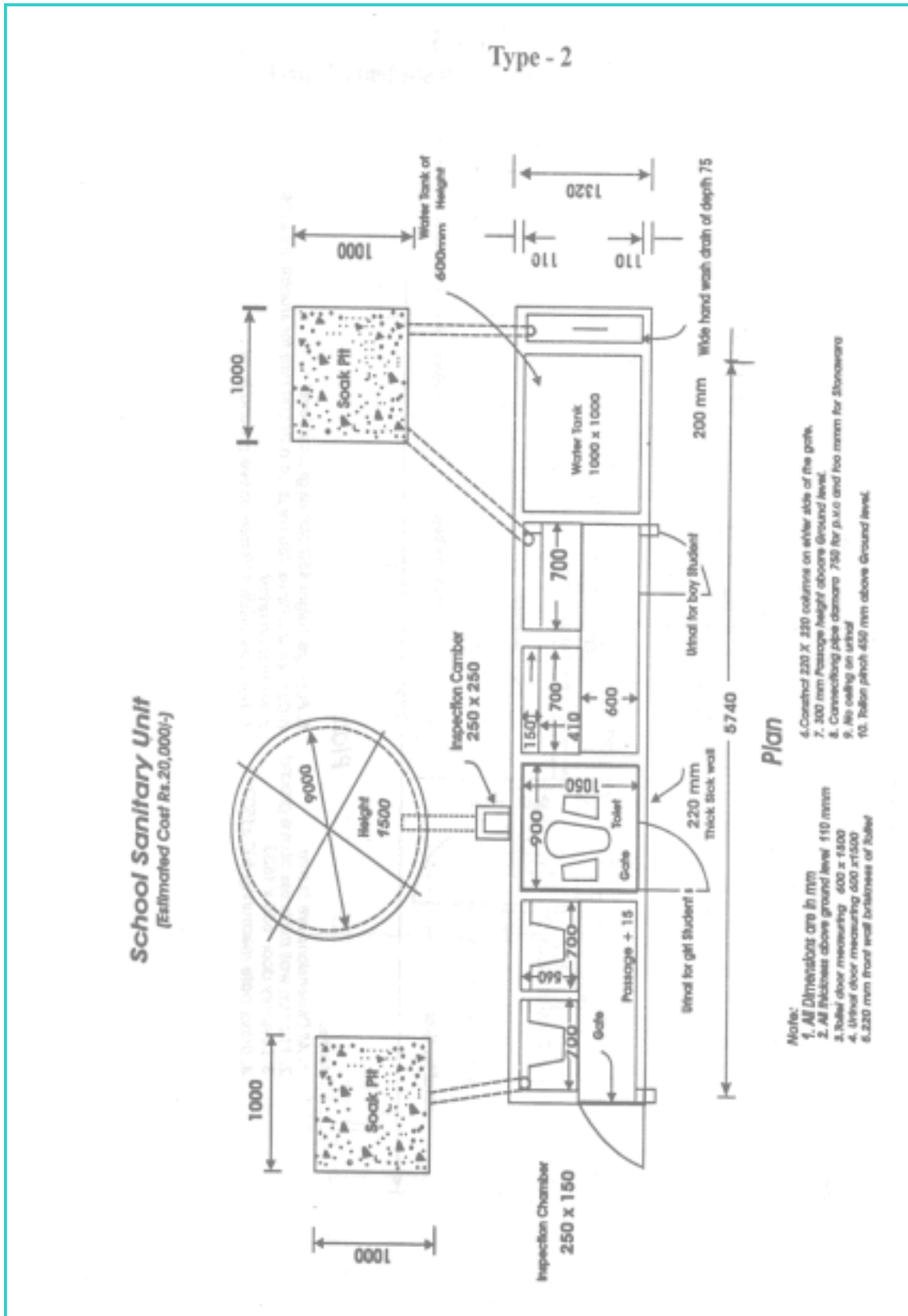

School Sanitary Design Option-3

Figure 17- Plan - Type-3

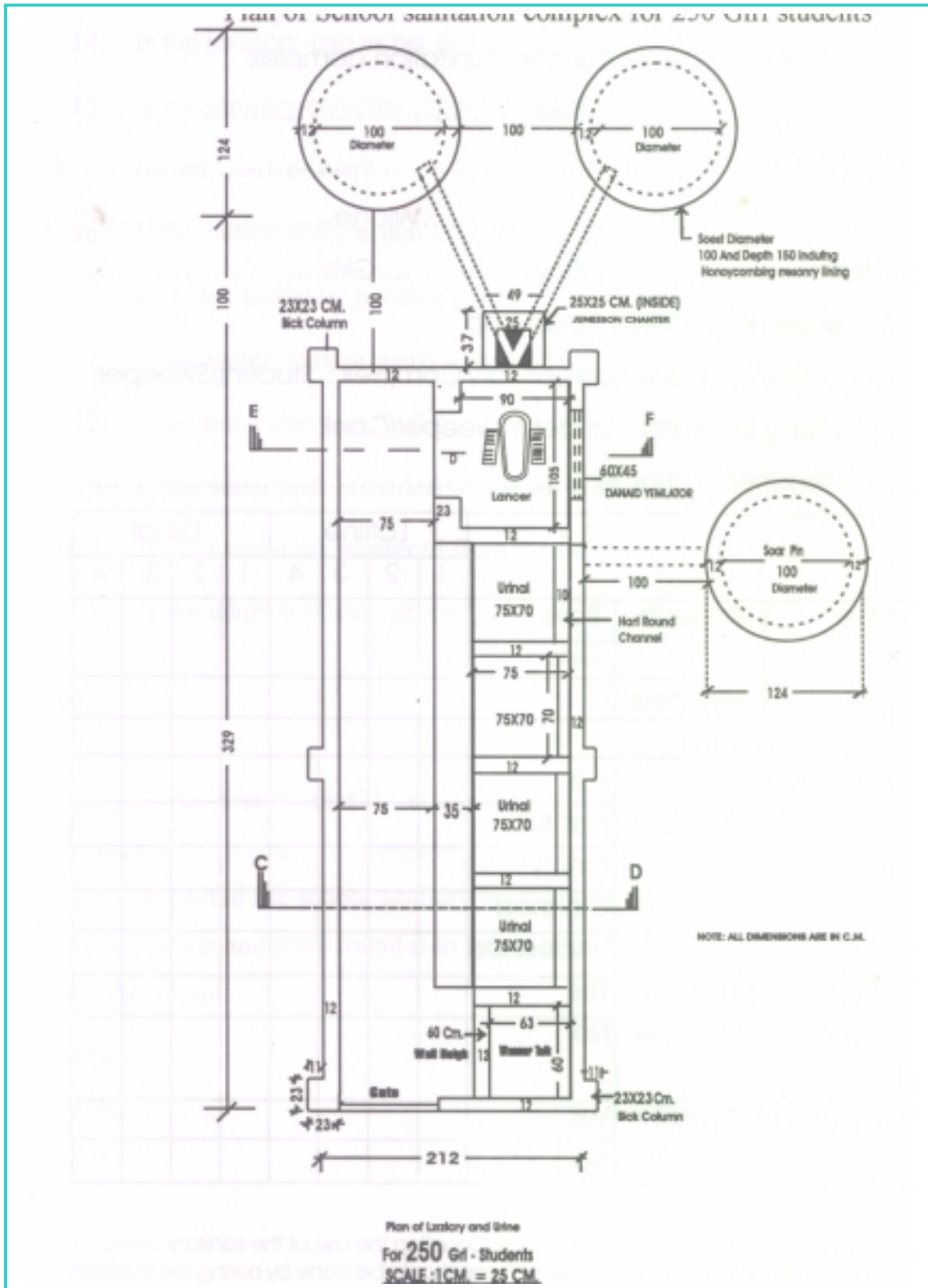

School Sanitary Design Option-3

Figure 18- Detail Plan

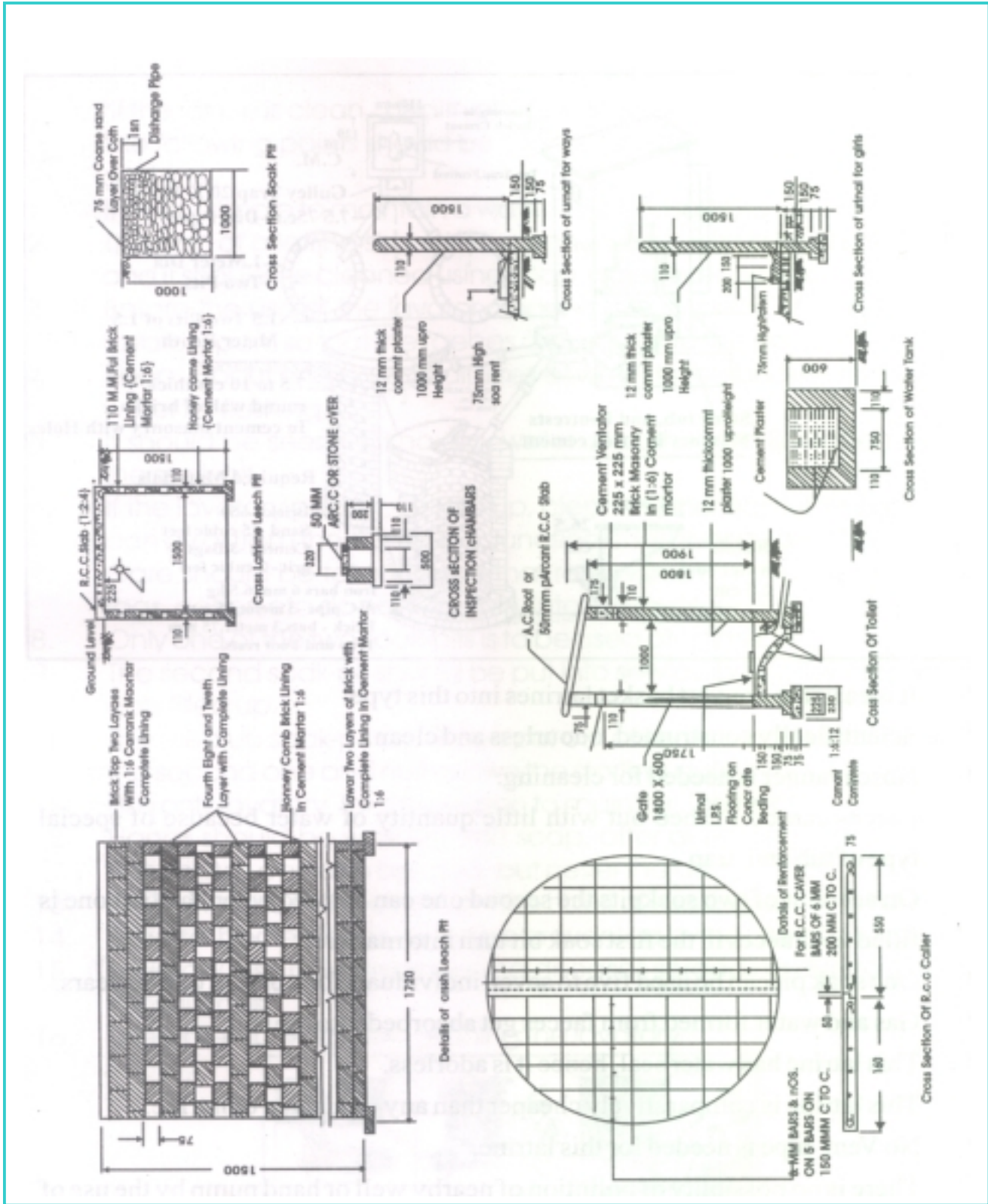

- **School Toilet Design Option 4**

This design option is for 500 and above girls at high school level. This design option has the provision of urinals, lavatory, hand washing and water tank facilities.

School Toilet Design Option 4- Part A

Figure –19 Plan and Cross Section

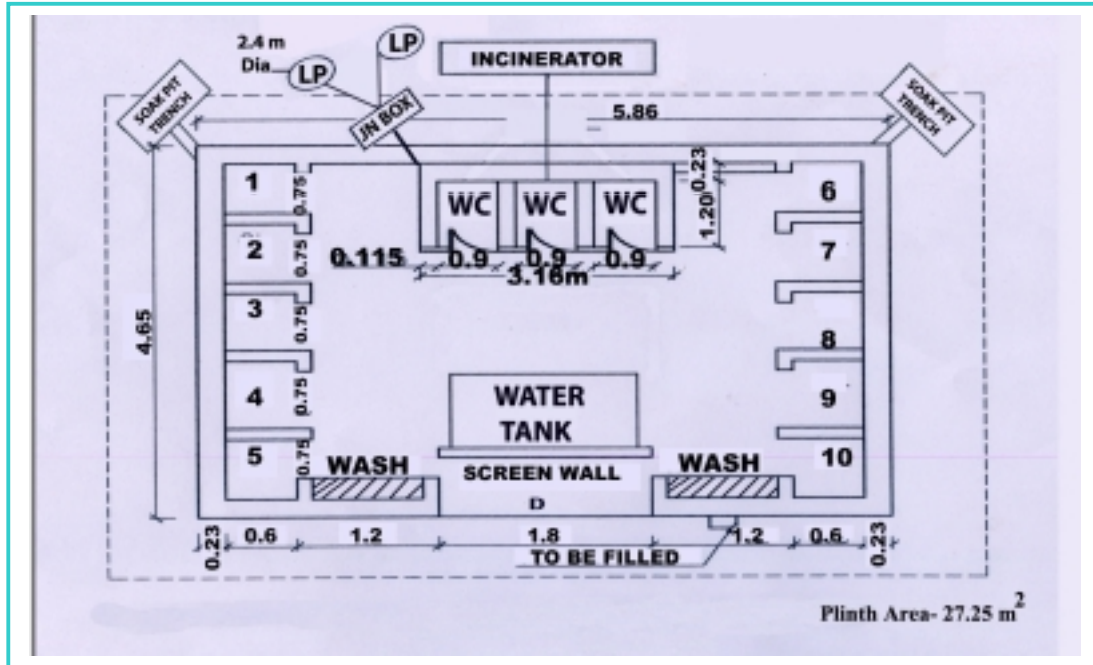

Part 2

Figure 20- Photograph of the Plan

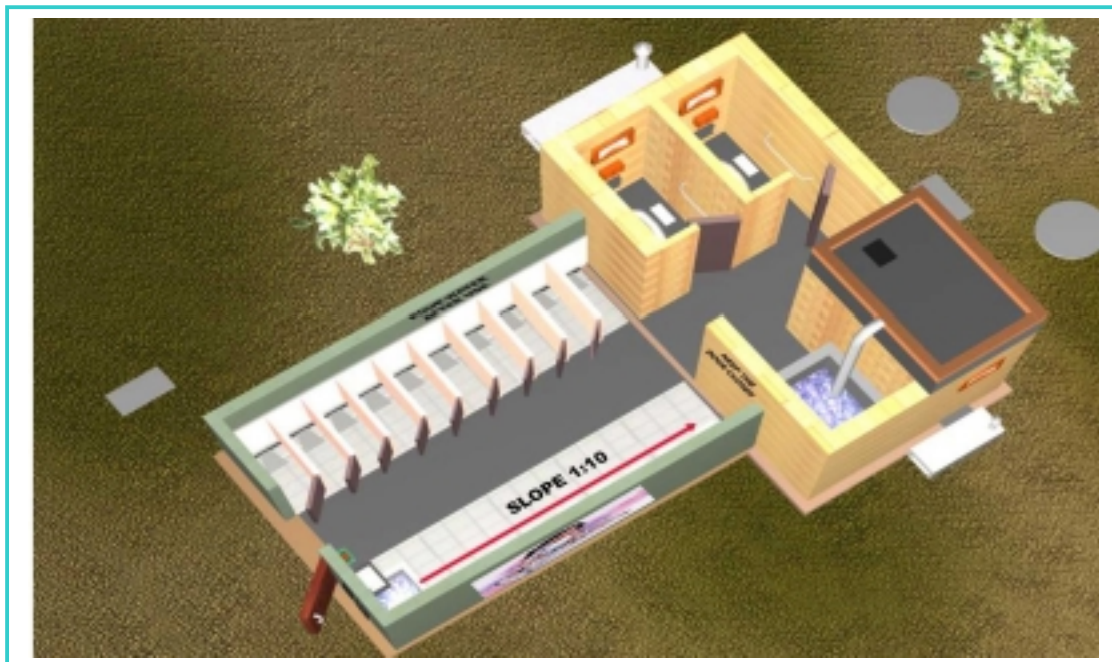

- **School Toilet Design Option 5**

This design option is for 500 and above boys at high school level. This has the same features as shown in the girls' high school toilet design.

School Toilet Design Option 5- Part A

Figure –21 Plan and Cross Section

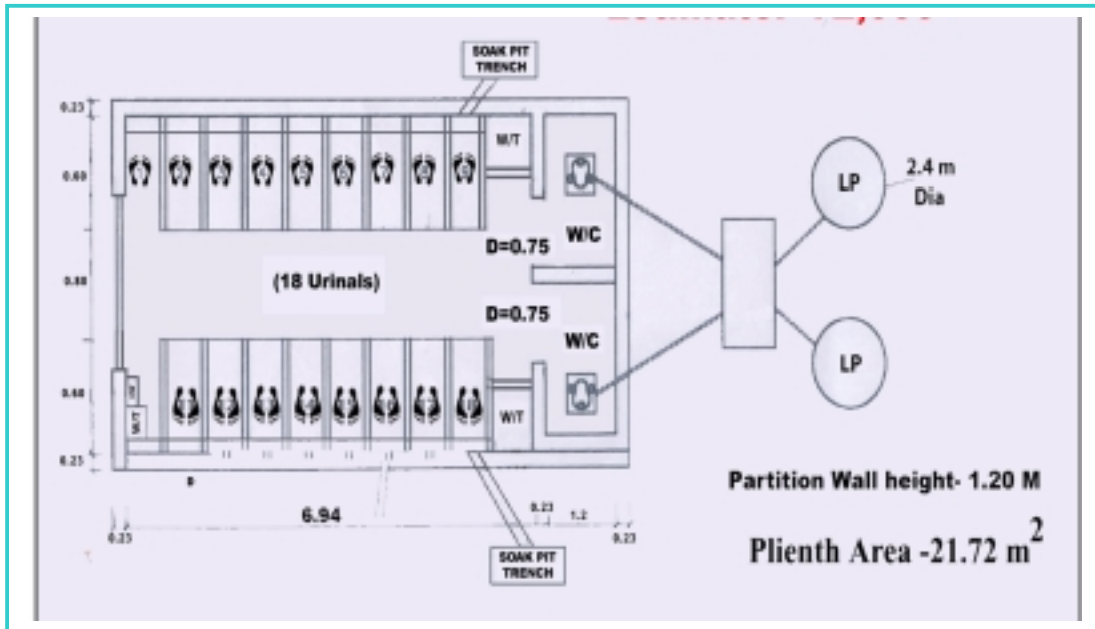

Part 2

Figure 22- Photograph of the Plan

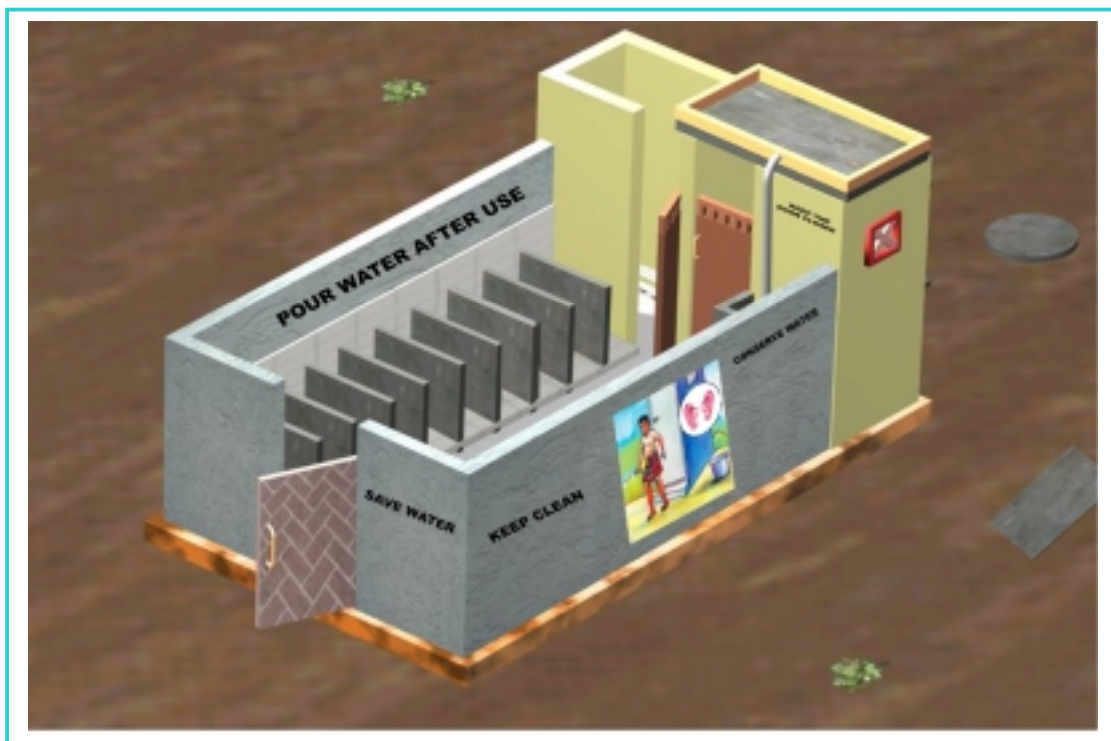

- **School Toilet Design Option 6**

This particular design option is suitable for situations where number of users is up to 500 students. In this option, the basic module consists of two independent enclosures for boys and girls with one lavatory and three urinals each. A water tank is also provided for pour-flush and hand-washing purposes, which is within each of the said enclosures. The twin pit pour-flush disposal system technology is used in it.

School Toilet Design Option 6

Figure 23- Type 1

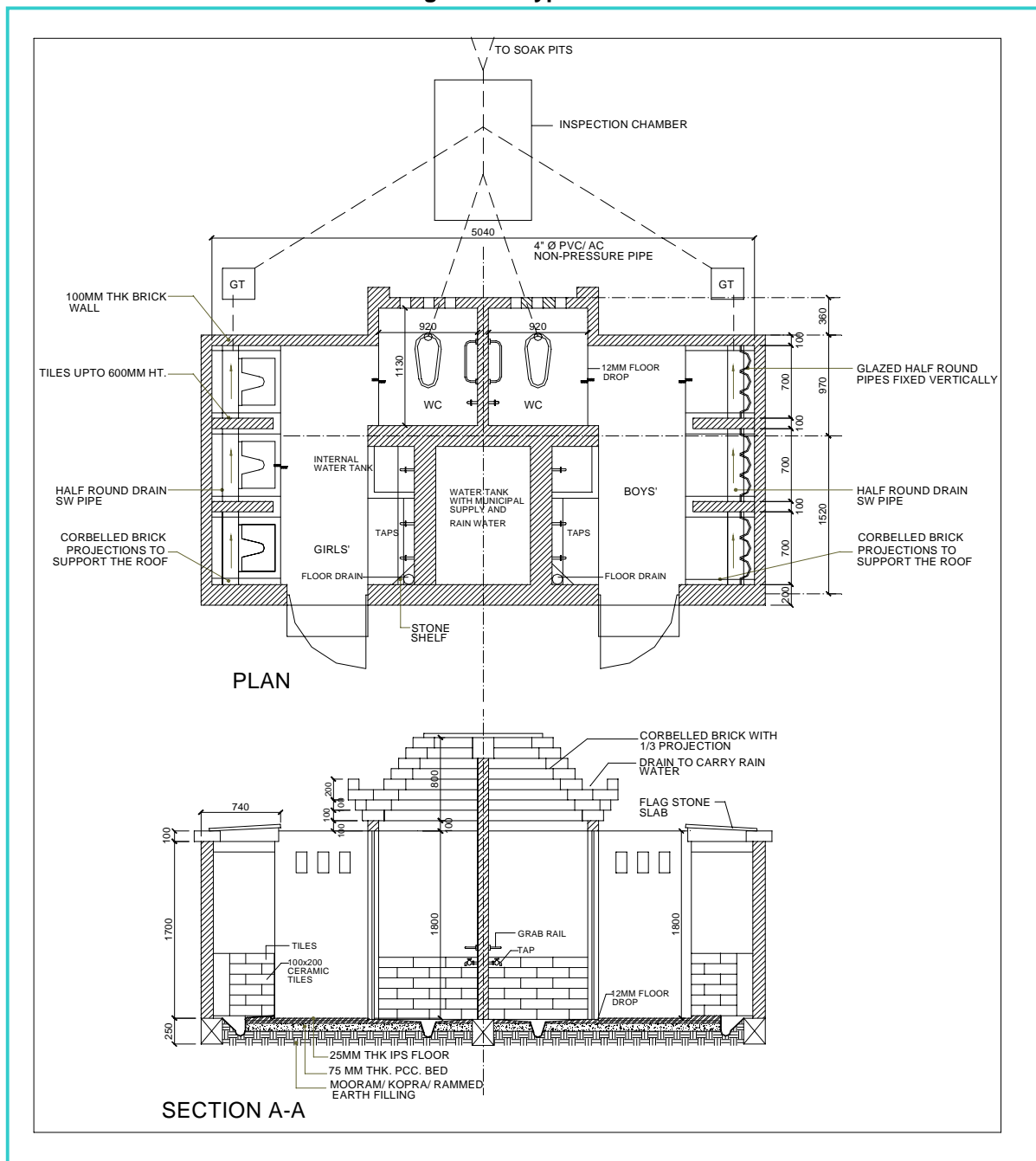

In the type two option, the basic module is same as type one. However, the same has been redesigned with a view to:

- increase privacy (positioning of entry door in such a way that it blocks visibility of internal activities);
- explore expansion possibilities through provision of a door opening at the rear, which presently can be filled in with a brick jali wall that can be removed as and when the need arises;
- position the hand-wash facility in such a way that that water from the same is channelised through the urinals, and as such acting as a self-cleansing agent.

School Toilet Design Option 6
Figure 24- Type- 2

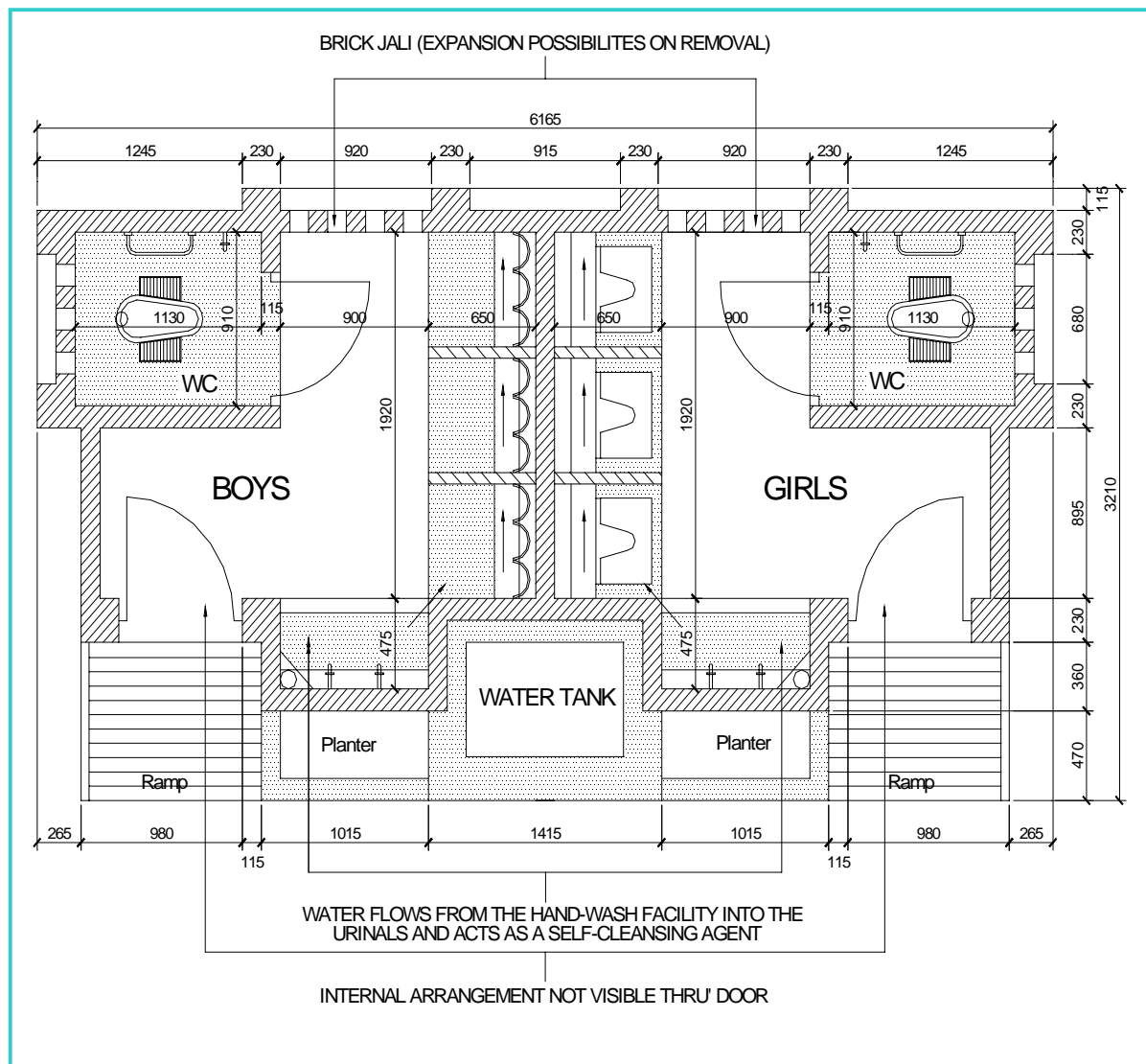

4. Why should one use rural pan in above mentioned design options?

Rural Pan should be preferred for the following reasons:

- The rural squatting pan spout diameter is less than the commercial pan (68mm) so that the curvature of the trap is comparatively lesser and requires minimum quantity of water for flushing the faecal matter.
- Bottom slope of the rural pan is very steep resulting high velocity of water and excess flushing.
- The cost of the rural pan is 1/2 of the commercial pan.
- The width of the squatting pan is comparatively less, which enables children to use them without fear and discomfort.
- The depth of the rural pan is more than the commercial pan so that the spillage can be avoided.

Figure 25- Rural and Commercial Pan Design

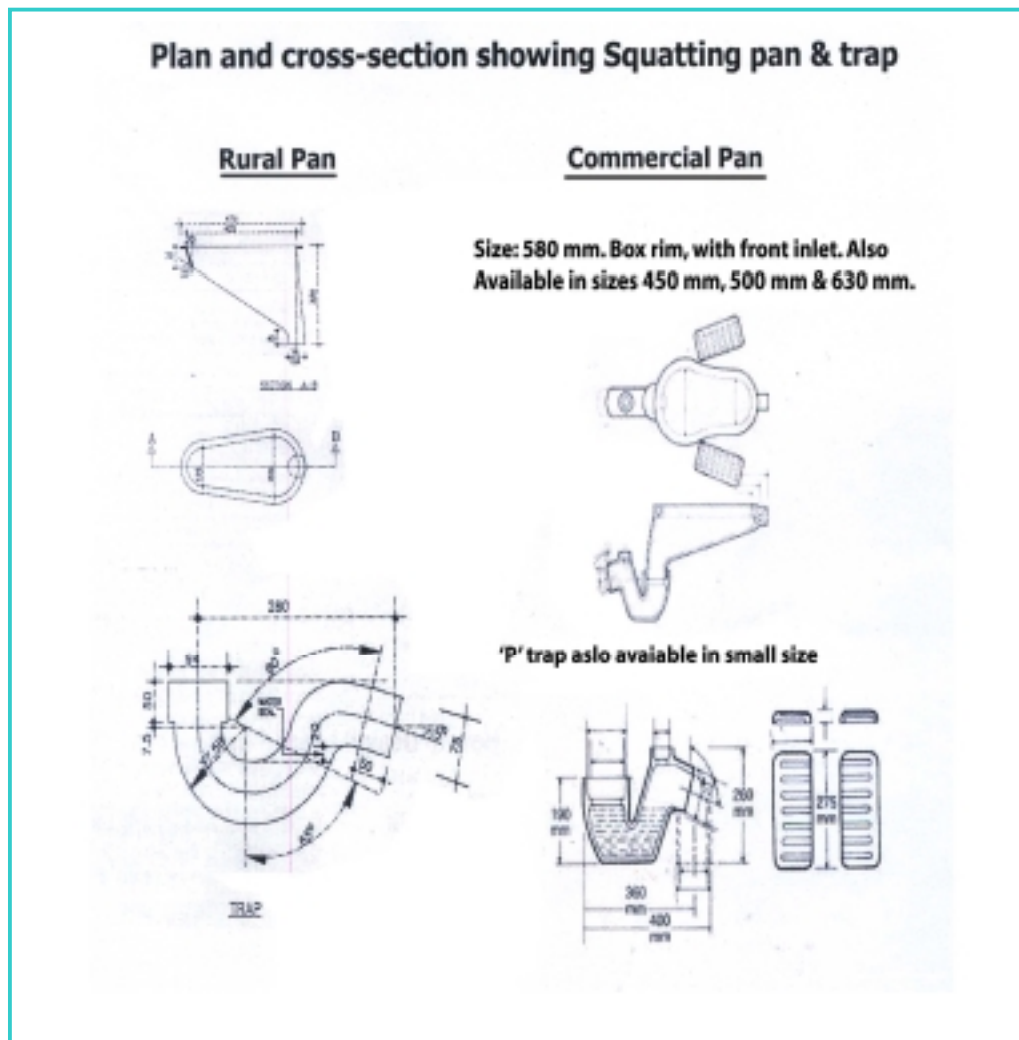

5. How many lavatories and urinals should be constructed in schools and Anganwadis?

Generally, one lavatory and three or four urinals for schools and one lavatory-cum urinal for Anganwadi are sufficient. For co-ed schools, two lavatories and six urinals i.e. one lavatory and three urinals for boys and one lavatory and three urinals for girls separately may be constructed. In fact, number of lavatory and urinals may be increased or decreased as per the strength of the students of respective schools. Also, by staggering the recess time, the pressure on the use of urinal may be reduced. This step is also being taken many States. An example of calculation is given below which help Programme Managers to arrive at expected lavatory and urinal requirement in their respective areas.

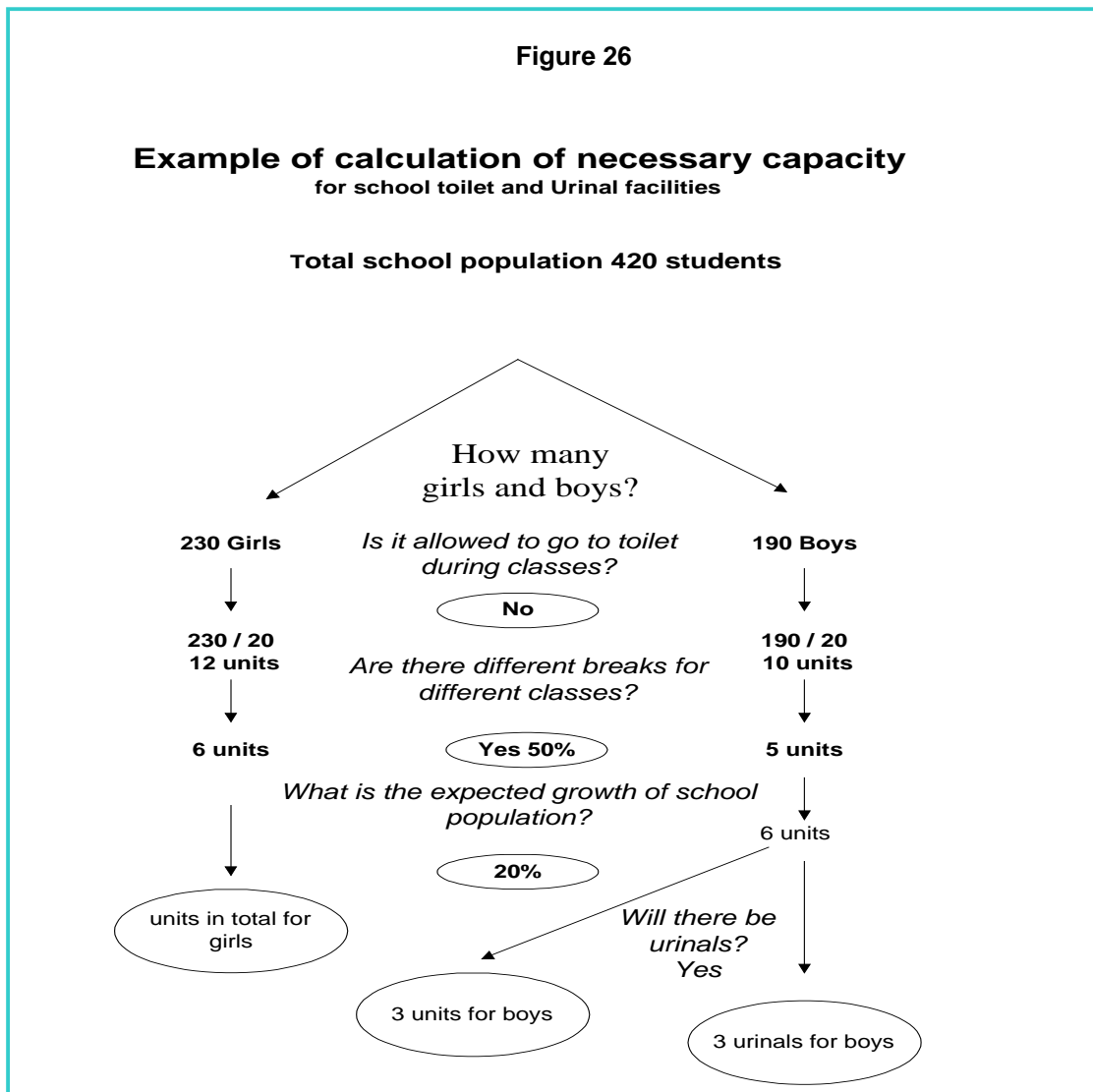

6. How to use and maintain school water and sanitation facilities?

A good organization of cleaning and maintenance of the water and sanitation facilities is of utmost importance. Badly maintained sanitation facilities often cause an even bigger health risk. Stagnant water around tap stands and in blocked drainage channels attracts rodents and forms a breeding place for mosquitoes. It is not so important who cleans and maintains facilities, but that arrangements for it are made, and that this is done before construction starts. A good cleaning and maintenance system requires funds, spare parts, people and equipment, and a clear division of roles and responsibilities among the actors involved.

- **Use and maintenance of facilities**

- All teachers and children should use water and sanitation facilities
- Facilities should be under lock and key.
- Teachers supervise and guide children for use of facilities.
- Allow sufficient time for students of each class (in case of staggered interval) to use facilities.
- Check storage for drinking water and re-fill during Mid Day.
- Allow drinking water to be stored in water drums with taps or use of ladles.
- Fill water storage containers for flushing in the morning and re-fill if required in the afternoon and provide each latrine with a bucket and mug/cup.
- Provide for cleaning materials and brush and for hand washing facilities close to the toilet with soap, bucket and mug.
- Conserve water and use water judiciously.
- Provide for drainage facilities at hand washing points.

- **Operation and Maintenance: Roles and Responsibilities**

There are several institutional bodies at school level, which are responsible for the operation and maintenance (O&M) such as **School Management's Committee (SMC)**, **School Watsan or Health Committee (SWC)**, **Parents and Teachers Association (PTA)** and **Gram Panchayat (GP)**. The involvement of above institutions is a basic prerequisite for a good O& M system. Their roles and responsibilities have been depicted in the following figure:

Figure 27

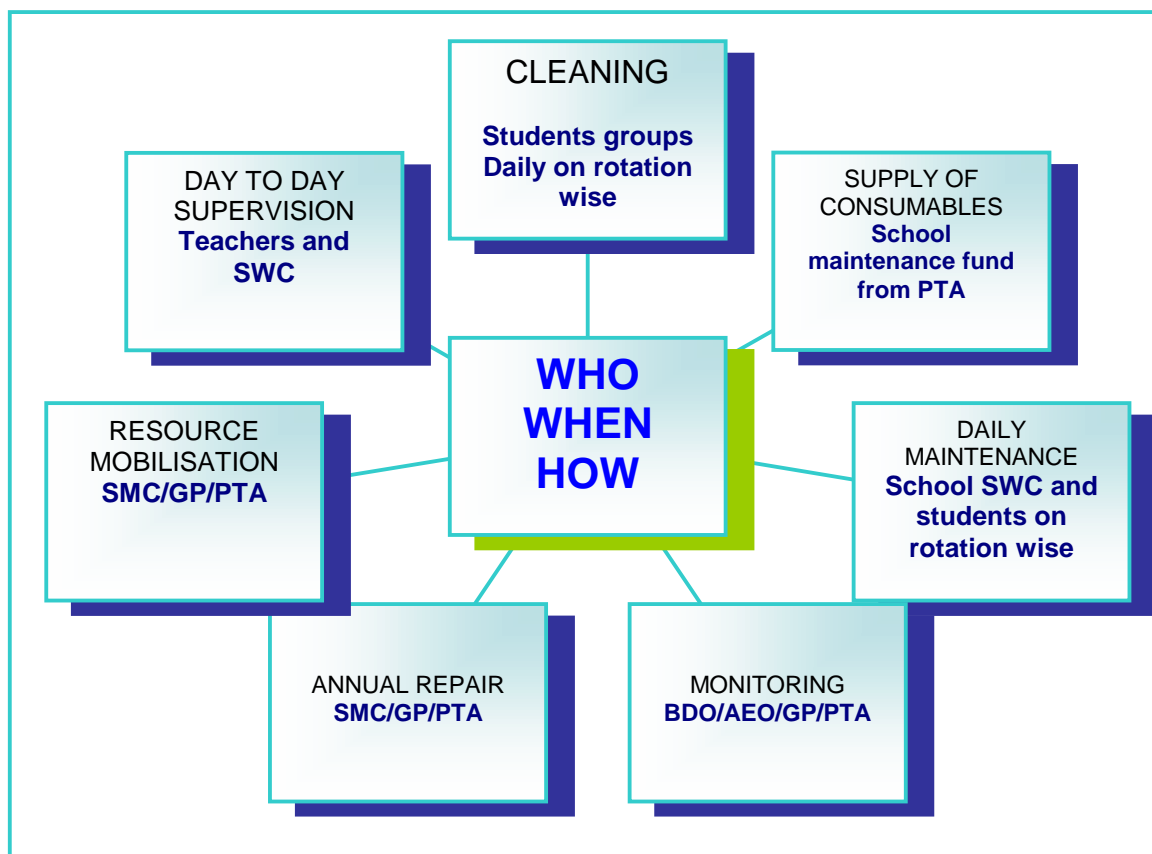

- **Resource mobilization and fund raising**

As sanitary facilities are an essential part of schools, the cost of their construction should be included in the budget. However, the construction and operation and maintenance of facilities are usually not included in a school's annual plan and therefore do not appear in the budget. It is important that schools and communities contribute as much as possible to the capital and O&M costs since:

- it will increase their feeling of responsibility and ownership of facilities;
- it will motivate them to maintain facilities;
- if the amount of external financing being sought is kept low, government and donors could support more schools.

It is important in this regard to distinguish between capital costs and O&M costs. Schools and communities may get some donor support to cover the capital cost, although it is best when they also contribute to cover these costs. In TSC,

PTA/GP/SMC have to make 10 percent contribution of the total cost of the toilet. To make school sanitation programmes sustainable, all O&M costs should also be covered by schools and communities. To avoid any misunderstanding it is best to make this clear in advance.

Possible funding options are:

- contributions from parents
- donations
- using the general school maintenance budget
- organization of income-generating activities
- contributions from teachers
- using fines

If funds are collected, transparency as to how they are spent is essential to avoid misuse or misunderstandings.

Important O&M Considerations

- The area around the sanitary complex should be kept clean.
- The floor of the urinal should be made wet before and after urination by pouring water over it so that it should not emit bad odor.
- Lavatory pan should be made wet by pouring a little water before use. The faeces do not stick to the surface and slips so that the pan can be flushed with less quantity of water.
- The lavatory pan should be cleaned daily.
- Care should be taken so that no clay or filth enters the urinal.
- No rubbish, rag or cotton finds entry into the lavatory pan.
- Do not use two leach pits simultaneously; when one leach pit is filled up, it is closed; and the other one is put into service.
- Repairs to the sanitary complex should be attended to immediately so that it can be used daily.
- The starting date of the use of a leach-pit should be noted so that the period in which it is filled up can be known.
- The public use of the complex should be prevented by locking the complex when the school closes.

Summary

There are various technologies and design options, which are children especially girl and disabled friendly. But it is also important that facilities created have to be kept clean and maintained to ensure better health and healthy environment for the development of the learning abilities of the children who will be using these facilities. The children are the change agents for the clean and healthy environment and sanitation facilities with hygiene education may help them to carry out the role of change agent effectively.





Annexures

Annexure1

Photograph 1

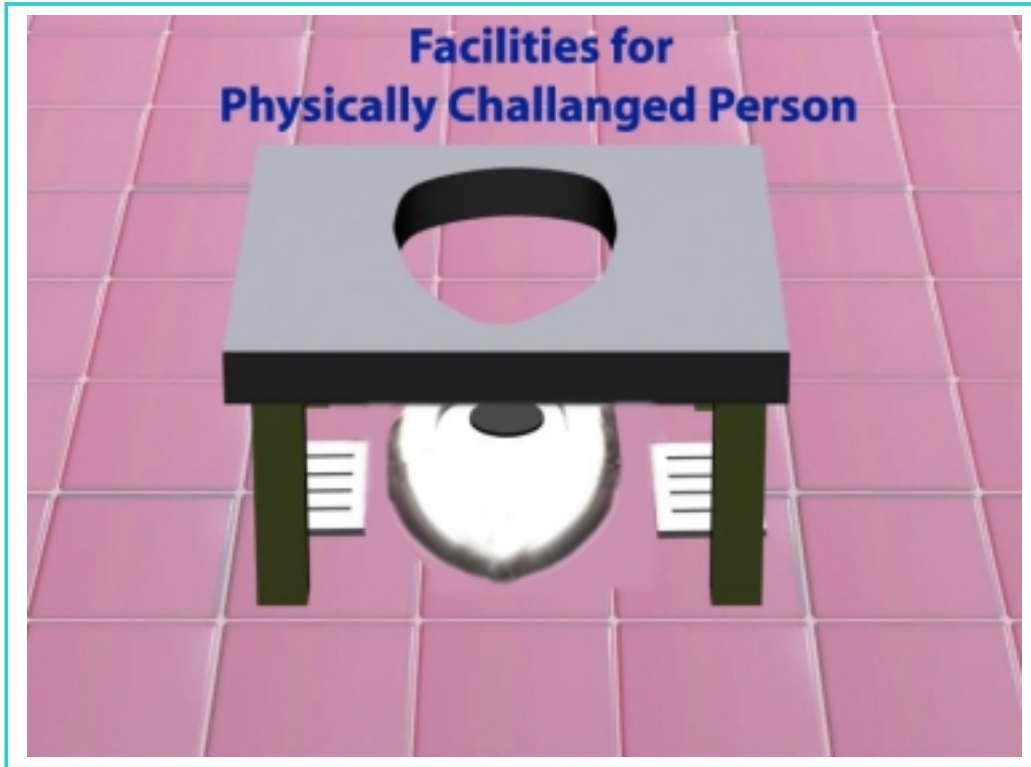

Annexure 2

Photograph 2

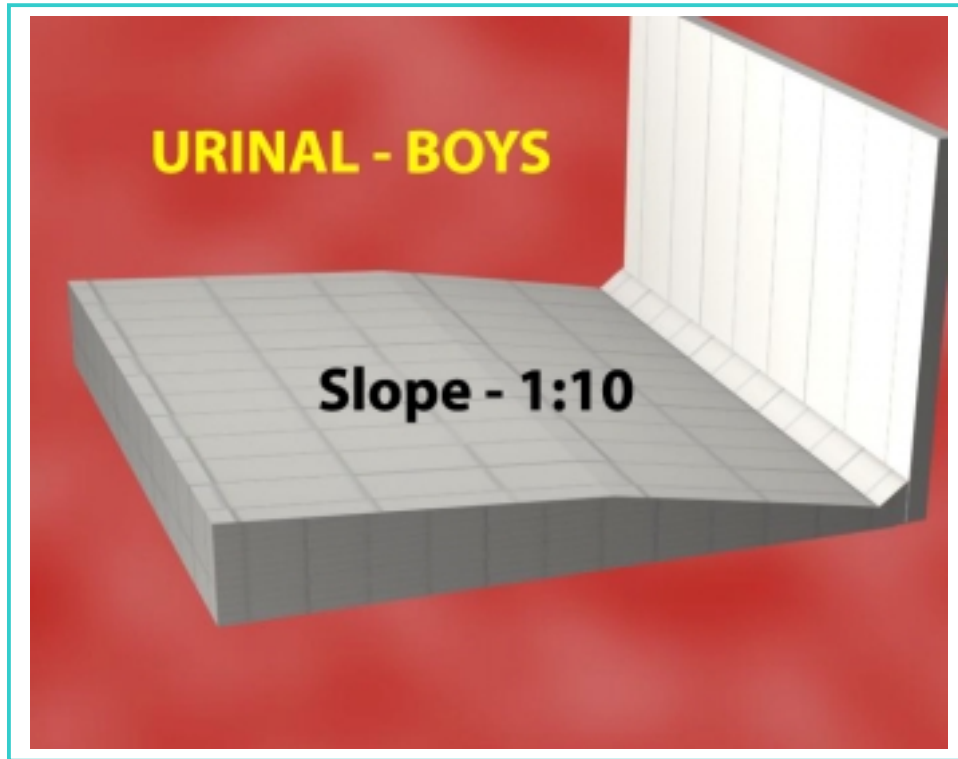

Photograph 3

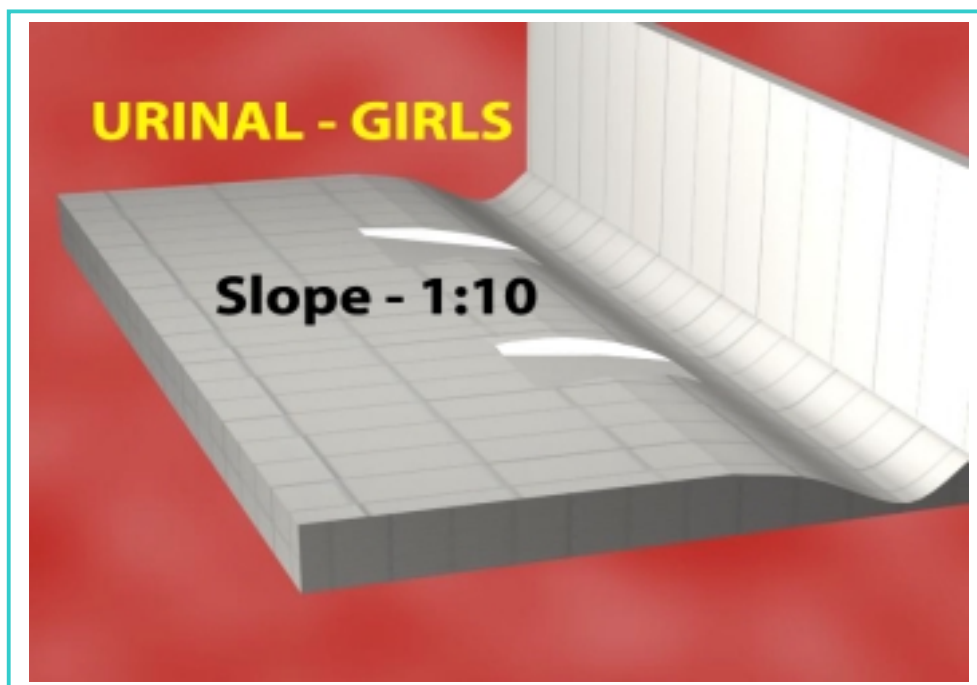

Annexure 3

Photograph 4

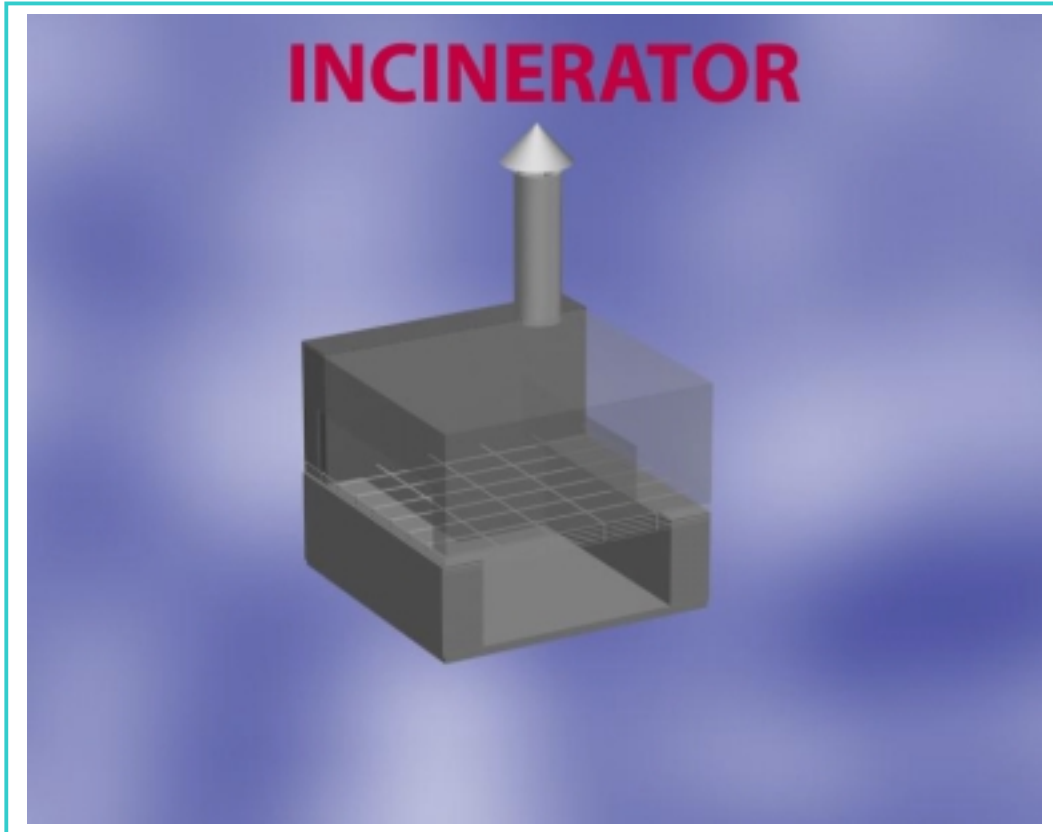

Photograph 5



Photograph 6

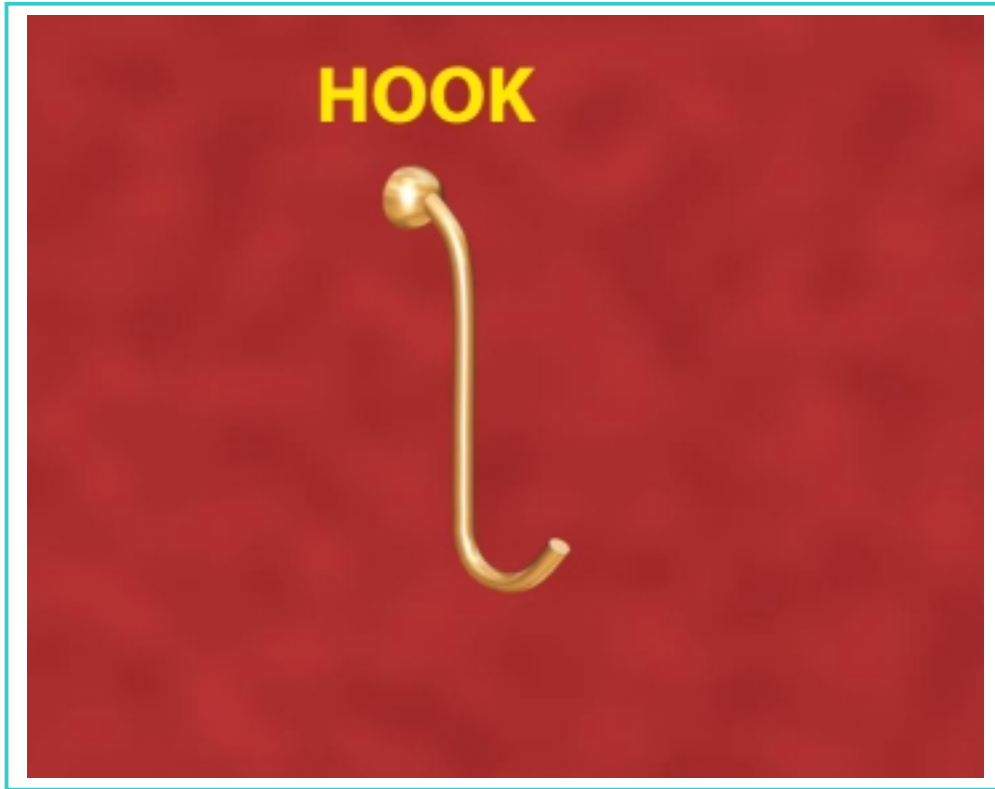

Annexure 4

Checklist regarding the quality of construction and completion of the work

Part A

1. Name of the school.....
2. Village.....
3. Gram Panchayat.....
4. Block.....
5. District.....
6. Date of the completion of the sanitary work.....

Part B

1. Is the gate of the sanitary complex property fixed? Is the quality of door of the latrine satisfactory?
2. Is the door of the latrine property fixed?
2. Are the aldrop and stopper of the door of the latrines all right?
3. How is the quality of the masonry work of the complex?
4. Is the junction chamber of the latrines proper?
5. Are the two soak pits provided with latrines?
6. Are the soak pits properly covered?
7. Is the urinals connected to soak pit?
8. Are the soak-pits of the urinal proper as per design?
9. How is the quality of the flooring of the latrines?
10. Is the slope of the gutter of the urinal proper?
11. Is the lavatory pan cleaned after fixing?
12. Is the lavatory pan as per design?
13. Is the sanitary complex properly cleaned before handed over?
14. Is the water tank properly constructed?
15. Is the water tank plastered from inside?
16. Is the white washing properly done?
17. Has the cost exceeded during construction?
18. Are the facilities for hand washing constructed?
19. Have the consumables been provided at the start of the sanitary complex?
20. Are children especially girls able to use the toilets, any testing done?

Annexure 5

Catching rain water from the roof of the school

Rainwater catching systems gather rainwater from the roof of school buildings. It has gutters and down pipes (made from wood, bamboo, galvanized iron sheet or PVC) that go to the storage containers from where they go to ground level tanks, sub surface sumps, plastic /sintex/cement tanks. Water is taken from the storage tank by tapping or lifting by Tara pumps or small-mechanized pumps. A foul flush device or detachable down pipe is needed to take off the first 20 litres of the runoff during a rainstorm as it is contaminated with dust, leaves, insects etc.

Just before the start of the rainy season, the complete system has to be checked for holes and that broken or affected parts are repaired, if necessary. During the rainy season the system has to be checked regularly, cleaned when dirty. Filters to be cleaned every few months and filter is sand washed at least every six months. Chlorination of the water may be necessary at frequent intervals.

Rooftop harvesting systems at schools can lose water from taps, if left dripping. Padlocks are, sometimes, needed to ensure misuse of stored water and ensure control over the supply.

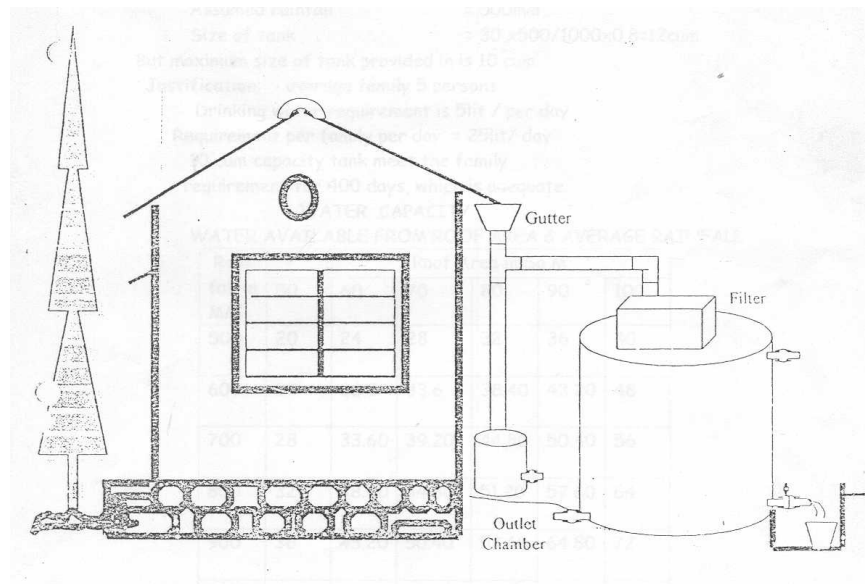

Roof Top Rain Water Harvesting (Direct Collection)