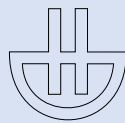


ACTION CONTRE LA FAIM

# Water, sanitation and hygiene for populations at risk



HERMANN

Water, sanitation and hygiene  
for populations at risk





ACTION CONTRE LA FAIM

Water, sanitation and hygiene  
for populations at risk

HERMANN  ÉDITEURS DES SCIENCES ET DES ARTS

*The illustration on the cover is from Souffles du monde–BKK, Erik Sampers, ACF Liberia.*

ISBN 2 7056 6499 8

© 2005 HERMANN ÉDITEURS DES SCIENCES ET DES ARTS, 6 RUE DE LA SORBONNE, 75005 PARIS

Toute reproduction ou représentation de cet ouvrage, intégrale ou partielle, serait illicite sans l'autorisation de l'éditeur et constituerait une contrefaçon. Les cas strictement limités à usage privé ou de citation sont régis par la loi du 11 mars 1957.

# Editorial

At the time of publishing this book, we know that around the world, more than 1 billion people do not have access to potable water and 2.4 billion people do not have access to basic sanitation facilities, consequently more than 15 000 people die each day from water borne diseases<sup>1</sup>.

The Action contre la Faim International Network (ACFIN)<sup>2</sup>, governed by Jean-Christophe Rufin, implements water and sanitation programs for populations in humanitarian situations. Water-supply and sanitation conditions directly affect health and food security and are key components in the fight against Hunger and Malnutrition. This fight leads us to work together with local vulnerable populations, and the general public, by organising awareness campaigns each year to improve the public knowledge about water and sanitation and the consequences it has on public health<sup>3</sup>. ACFIN defends the right to have water accessible for everyone.

The present edition was coordinated by Hubert Sémiond and Francisco González, respectively head of the *Action contre la Faim* and *Acción contra el Hambre* water and sanitation departments.

This edition is the second edition of "Alimentation en eau des populations menacées", by Éric Drouart and Jean-Michel Vouillamoz, published in 1999, that has been deeply reviewed, revised, updated and extended, with more than 60% of new information.

The main contributors to this edition are (in alphabetical order) : Francisco González (Curro), Jean Lapegue, Élisabeth Lictevout, Hubert Sémiond, Álvaro de Vicente and Jean-Michel Vouillamoz. An exhaustive list of authors is presented in the summary.

The final English version has been entirely reviewed by John Adams.

This book is the summary of more than ten years experience of project implementation in water supply, sanitation and hygiene promotion, for populations in danger. This field experience has been strengthened and informed by the scientific research, technical development and literature review that *Action contre la Faim* permanently undertakes to optimise its interventions. One of the purposes of this second edition is to capture recent experiences and expertise developed by the *Action contre la Faim* international network.

The present edition particularly benefited from the PhD work done on groundwater prospecting by Jean-Michel Vouillamoz between 2001 and 2003 in collaboration between *Action contre la Faim*, the *Institut de Recherche pour le Développement* (IRD) and the *Bureau de Recherche Géologique et Minière* (BRGM).

This work is the fruit of teamwork and of the dynamism that has driven the Water and Sanitation department since its creation in Paris and later in Madrid, New York and London. But above all, this book is the result of the strong commitment and creativity of the *Action contre la Faim* teams on the field, national and international staff, who developed appropriate technology and approaches in collaboration with the beneficiary communities.

---

1. Kofi Annan, Summit of Johannesburg (30.08.2002).

2. ACFIN include four headquarters: Paris, Madrid, London and New York.

3. Water Day ACF event's.

This book has come into existence thanks to the confidence shown and the resources provided by *Action contre la Faim* in order to facilitate the project. Our thanks are due to all the team, and especially to Jean-Luc Bodin, who has sustained and accompanied the development of the Water and Sanitation department since its creation and strongly encouraged and supported the first edition. The publication and the promotion of this second edition was followed up by Frank Hourdeau.

We would also like to thank our partners from the NGO's community and donors, with whom we collaborate daily to implement water and sanitation programs.

The main objective of this book is to transfer our knowledge acquired from years of experience in the field, in order to better reach the largest possible number of national and international humanitarian actors.

Happy reading!

Benoît MIRIBEL  
*Executive director*



# Acknowledgements

Many people have contributed to the writing of this book, (the main authors are mentioned in the following table). For their contributions to the first edition that is basis of this book (and for their great humour), thanks are due to Jocelyn Lance, previous manager of the Water and Sanitation Department of *Accion Contra el Hambre* for his enthusiasm, his unshakeable interest in innovative techniques, and his capacity to fly in all weathers. Thanks also to Alexandre Langlois, Miguel Ángel Barba, David Blanc, Paul Cottavoz, Patrick Dannard, José Benavente, Philippe Masliah, Dominique Porteau, Philippe Leborgne, Jean-Pierre Veyrenche and Philippe Weis.

For the second edition, thanks are due to John Adams for his holistic knowledge of humanitarian interventions that led to numerous comments and corrections. Thanks are due to Loïc Raigondeau for the detail of his work. For their various contributions thanks are due to Pierre Fourcassié, Thierry Arhan, Cyndy Cushner, Serge Breysse, Hervé Bonino, Pablo Alcalde, Alejandro Zurita, Olivier Seyiadji, Massimo Caporilli, Carmelo Gallardo, Amador Gómez, Marta Valdés, Julián Carrazón, Zaza Gvelesiani, Anne Boemare, Bertrand Brecqueville, Daniel Chevrolet and June Hirsh. Finally, thanks are due to Paul Cottavoz and Olivier Stoupy for the spirit they gave to the department and that is reflected in this present edition.

For their English translations and revisions, thanks to Mark Rowney, Jose de Bettencourt, Michael Walls, Andrew Mitchell, Cyndy Cushner, Lisa Rudge, Chris Wardle, Lisa Ernoult, Kate Ogden and Caroline Wilkinson. We are also grateful to Marián Hernández, BA and M Shields, FIInfSc, MITI, for carrying out the main part of the translation, often in place of more lucrative work.

Thanks also to the people who at professional, personal or family levels suffered from the energy invested in this project. It is difficult to mention all of them, but a specific mention is due to Virginie, Raphaël, Marianne, Olivier, Pilar, Candela, Beatrice, Lucas, Iris, Carlos, Luna, Chine, Elisabeth and Tristan for the laborious evenings, weekends and holidays. Thanks also to Caroline Broudic and Helene Deret for their patience and their support to the field, and to many others in the field or in headquarters.

Finally, thanks to Jacques-Henry Lahaye, Loïc Raigondeau and Álvaro de Vicente for their talent in producing the technical diagrams.



# Summary

ACTION CONTRE LA FAIM	xx
The Charter	xx
I PROGRAMME DEVELOPMENT	1
1 ACF intervention policy and strategy (F. GONZÁLEZ, H. SÉMIOND)	3
1 Global water and sanitation problem	3
2 Crises and humanitarian contexts	4
2.1 <i>Typology of humanitarian contexts</i>	4
2.2 <i>Humanitarian situations and their evolution</i>	6
2.3 <i>Mechanisms of response</i>	8
2.4 <i>Technical intervention and advocacy</i>	9
3 Water and sanitation programmes	9
3.1 <i>Programme objectives</i>	9
3.2 <i>Intervention domains and activities</i>	12
4 Intervention criteria	13
4.1 <i>General considerations</i>	13
4.2 <i>General criteria</i>	14
4.3 <i>Specific criteria</i>	15
4.4 <i>Target population</i>	15
4.5 <i>Definition of priorities</i>	15
5 Intervention principles	16
5.1 <i>A direct approach to populations</i>	16
5.2 <i>A response that depends on analysis</i>	17
5.3 <i>Multidisciplinarity analysis</i>	17
5.4 <i>Involvement of affected communities</i>	17
5.5 <i>Understanding, respecting and integrating local factors</i>	18
5.6 <i>Sustainable impact of activities</i>	18
5.7 <i>Coordinating activities</i>	19
5.8 <i>Community strengthening</i>	20
5.9 <i>Gender issues</i>	20
5.10 <i>Capitalising on experience and analysis</i>	20
5.11 <i>Respect for the environment</i>	20
2 Project management (F. GONZÁLEZ, E. LICTEVOUT)	21
1 Management of water and sanitation programmes	21
1.1 <i>Project-cycle management</i>	22
1.2 <i>Guidelines and standards</i>	24
2 Needs assessment and project identification	25
2.1 <i>Objectives of needs assessment</i>	25
2.2 <i>Water and sanitation-related diseases</i>	27
2.3 <i>Assessment components</i>	29
2.4 <i>Resources and means to do an assessment</i>	31
2.5 <i>Information gathering</i>	31
2.6 <i>Assessment in emergencies</i>	38
2.7 <i>Sanitary surveys</i>	39

3	Project design	39
3.1	<i>Analysis phase</i>	39
3.2	<i>Planning phase</i>	45
3.3	<i>Proposal writing</i>	52
3.4	<i>Project approval and financing</i>	53
4	Project implementation and monitoring	53
4.1	<i>Planning</i>	54
4.2	<i>Staff management</i>	55
4.3	<i>Internal procedures</i>	57
4.4	<i>Security and safety awareness</i>	58
4.5	<i>Community involvement</i>	60
4.6	<i>Management of information, lessons learned and reporting</i>	60
4.7	<i>Monitoring</i>	61
5	Evaluation	62
	<i>Main criteria used for project evaluation</i>	62
II	WATER RESOURCES	65
3	Water resources (J.M. VOUILLAMOZ)	67
1	The water cycle	67
2	Rainwater	68
2.1	<i>The water layer concept</i>	69
2.2	<i>Rainfall measurement</i>	69
3	Surface water	70
3.1	<i>The catchment area concept</i>	70
3.2	<i>Run-off assessment</i>	70
3.3	<i>Flow-rate measurement</i>	71
4	Groundwater	76
4.1	<i>Water within rock</i>	76
4.2	<i>Main aquifer systems</i>	85
4.3	<i>Aquifer recharge</i>	93
4.4	<i>Groundwater quality</i>	94
4	Water quality and analysis (J. LAPEGUE, H. SÉMIOND)	97
1	Water quality and programme strategy	98
1.1	<i>Water quality and public health</i>	98
1.2	<i>Water quality and programme profile</i>	98
1.3	<i>Water quality through programme steps</i>	99
1.4	<i>Water resources and water quality</i>	103
2	Standards and guidelines	106
2.1	<i>The concept of pollution</i>	106
2.2	<i>The concept of toxicity</i>	107
2.3	<i>Quality standards, guidelines and indicators</i>	108
3	Quality indicators	112
3.1	<i>Sanitary surveys and risk assessments regarding water quality</i>	112
3.2	<i>Biological analysis</i>	114
3.3	<i>Physicochemical characteristics</i>	115
3.4	<i>Major ions</i>	119
3.5	<i>Trace-elements and toxic minerals</i>	121
3.6	<i>Biological indices</i>	122

4	Water analysis	123
	4.1 <i>Sampling</i>	123
	4.2 <i>Methods of analysis</i>	125
	4.3 <i>Presentation of results and interpretation</i>	128
5	Groundwater prospecting	131
A	<i>Hydro-geophysical studies</i> (J.M. VOUILLAMOZ)	131
	1 Questions facing the prospector	131
	2 Preliminary actions	132
	2.1 <i>Available information</i>	132
	2.2 <i>Cartography</i>	133
	2.3 <i>Satellite images</i>	134
	2.4 <i>Photo-interpretation</i>	134
	3 Field survey	135
	3.1 <i>The preliminary visit</i>	135
	3.2 <i>Technical meetings</i>	136
	3.3 <i>Additional investigations</i>	136
	4 Hydro-geophysical methods	136
	4.1 <i>Introduction to the methods</i>	137
	4.2 <i>The Electrical Resistivity method</i>	140
	4.3 <i>Electromagnetic methods</i>	160
	4.4 <i>Magnetic Resonance Sounding</i>	168
	5 Prospecting procedures	177
	5.1 <i>Exploration boreholes</i>	177
	5.2 <i>Assessment of the resource</i>	177
	5.3 <i>Storage of results and analytical tools</i>	177
	5.4 <i>Prospecting procedures</i>	178
B	<i>Field examples</i> (J.M. VOUILLAMOZ)	188
	1 Implementing boreholes in unconsolidated sediments	188
	1.1 <i>Background</i>	188
	1.2 <i>Results example</i>	191
	1.3 <i>Discussion</i>	196
	2 Characterisation of crystalline bedrock aquifers	199
	2.1 <i>Background</i>	199
	2.2 <i>Main results</i>	200
	2.3 <i>Conclusion</i>	203
	3 Localisation of saturated karst aquifers	204
	3.1 <i>Background</i>	204
	3.2 <i>Field example</i>	207
	3.3 <i>Conclusion</i>	208
6	Pumping test (J.M. VOUILLAMOZ)	211
	1 Aquifer test	212
	1.1 <i>Diagnostic graphs</i>	212
	1.2 <i>Choice of model</i>	215
	1.3 <i>Jacob's method</i>	215
	1.4 <i>Theis's recovery method</i>	218
	2 Well-test	219
	2.1 <i>Non-connected steps</i>	219
	2.2 <i>Connected steps</i>	228



3	Pumping-test procedure	233
3.1	<i>Design of test</i>	233
3.2	<i>Test implementation</i>	236
3.3	<i>Reporting</i>	238
III	WATER SUPPLY	239
7	Wells	241
A	<i>Well construction</i> (S. DESANLIS, J.M. VOUILLAMOZ, T. MÉTAIS, H. SÉMIOND)	241
1	Modern wells	241
1.1	<i>Surface works</i>	242
1.2	<i>Manual water drawing</i>	242
1.3	<i>Diameter</i>	244
1.4	<i>Well lining</i>	245
1.5	<i>Intake column</i>	245
2	Construction techniques	245
2.1	<i>Digging</i>	245
2.2	<i>Lining</i>	246
2.3	<i>Independent intake</i>	251
2.4	<i>Developing the well</i>	252
2.5	<i>Use of explosives</i>	254
2.6	<i>Deep wells in Mali</i>	255
3	Rehabilitation of wells	255
3.1	<i>Why rehabilitate?</i>	255
3.2	<i>Rehabilitation of the well lining</i>	256
3.3	<i>Cleaning and deepening</i>	257
4	Disinfection	258
B	<i>Field examples</i> (E. DROUART, J.M. VOUILLAMOZ)	259
1	Implementation	259
1.1	<i>Quantity estimates</i>	259
1.2	<i>Time necessary for the construction of a well</i>	260
1.3	<i>Planning the construction of ten wells</i>	261
2	Resources required	262
2.1	<i>Human resources</i>	262
2.2	<i>Materials</i>	262
2.3	<i>Equipment</i>	263
8	Boreholes	265
A	<i>Borehole drilling</i> (J.M. VOUILLAMOZ, E. DROUART, H. SÉMIOND, B. LEMOAL, F. ROBERT)	265
1	Drilling for water	266
1.1	<i>Exploration</i>	266
1.2	<i>Exploitation</i>	266
1.3	<i>Examples of borehole costs</i>	267
2	Drilling techniques	267
2.1	<i>Rotary drilling</i>	267
2.2	<i>Down-the-hole hammer drilling</i>	268
2.3	<i>Borehole parameters</i>	269
3	Lightweight drilling rigs	274
3.1	<i>ACF-PAT 201 kit</i>	274
3.2	<i>ACF-PAT 301 kit</i>	275

3.3	<i>ACF-PAT 401 PTO kit</i>	279
3.4	<i>Other lightweight drilling rigs</i>	279
4	Borehole design	282
4.1	<i>Choice of casing</i>	282
4.2	<i>Pre-casing</i>	284
4.3	<i>Usual configurations</i>	284
5	Borehole drilling	286
5.1	<i>Choice of technique</i>	286
5.2	<i>Site preparation</i>	286
5.3	<i>Rotary drilling</i>	290
5.4	<i>DTH percussion drilling</i>	293
6	Borehole equipping	297
6.1	<i>Permanent casing</i>	297
6.2	<i>Gravel pack and grouting</i>	300
7	Development	301
7.1	<i>Borehole cleaning</i>	302
7.2	<i>Development processes</i>	302
7.3	<i>Instantaneous flow</i>	305
8	Monitoring and borehole report	305
9	Surface works	306
<b>B</b>	<b><i>Borehole rehabilitation (H. SÉMIOND, J.M. VOUILLAMOZ, J.G. MOULIN)</i></b>	<b>307</b>
1	Introduction	307
2	Description of the causes of borehole deterioration	307
2.1	<i>Electrochemical and bacterial corrosion</i>	308
2.2	<i>Mechanical, chemical and biological clogging</i>	308
2.3	<i>Erosion</i>	309
3	Diagnosis	309
3.1	<i>Methodology</i>	309
3.2	<i>Data analysis</i>	310
4	Intervention techniques	310
4.1	<i>Development</i>	312
4.2	<i>Bailing and over-drilling</i>	312
4.3	<i>Re-equipment</i>	312
4.4	<i>Unclogging</i>	312
4.5	<i>Rehabilitation of surface works</i>	313
5	Preventive maintenance	314
6	Condemning a borehole	314
<b>C</b>	<b><i>Field examples (J.M. VOUILLAMOZ, J.G. MOULIN)</i></b>	<b>315</b>
1	Planning a drilling programme	315
2	Resources to be mobilised	316
2.1	<i>Human resources</i>	316
2.2	<i>Drilling costs</i>	316
3	Overview of selected programmes	319
3.1	<i>Non-consolidated sedimentary area</i>	319
3.2	<i>Bedrock area</i>	322
<b>D</b>	<b><i>Combined wells (J.P. VEYRENCHÉ, J.M. VOUILLAMOZ, T. MÉTAIS, H. SÉMIOND)</i></b>	<b>325</b>
1	Central combined wells	325
1.1	<i>Implementation</i>	325
1.2	<i>Resources required</i>	327

2	Lateral combined well	328
	2.1 <i>Implementation</i>	328
9	Pumping systems (O. STOUPIY, J.M. VOUILLAMOZ, F. FOURTUNE, B. LEMOAL)	331
	1 General	331
	2 Motorised pumps	332
	2.1 <i>Working principles of centrifugal pumps</i>	332
	2.2 <i>Centrifugal pump sealing</i>	333
	3 Pumping hydraulics	334
	3.1 <i>Power</i>	334
	3.2 <i>Suction head</i>	334
	3.3 <i>Flow and Total Manometric Head (TMH)</i>	335
	3.4 <i>Working point in a pipe system</i>	337
	3.5 <i>Particular characteristic curves</i>	337
	4 Choosing a motorised pump	340
	4.1 <i>Surface centrifugal motorised pump</i>	340
	4.2 <i>Submersible electrical pump</i>	342
	5 Electricity supply	343
	5.1 <i>Power and current</i>	344
	5.2 <i>Generator choice</i>	345
	6 Dewatering pumps	346
	6.1 <i>Principle and material</i>	346
	6.2 <i>Electric dewatering pumps</i>	346
	6.3 <i>Pneumatic water pumps</i>	347
	7 Renewable energy pumps	347
	7.1 <i>Solar pumping</i>	348
	7.2 <i>Hydraulic energy</i>	350
	8 Handpumps	353
	8.1 <i>Main types of handpump</i>	353
	8.2 <i>Piston pumps</i>	354
	8.3 <i>Hydraulic pumps</i>	356
	8.4 <i>Helical rotary pump</i>	358
	8.5 <i>Rope-and-washer pump</i>	359
	8.6 <i>Treadle pump</i>	360
10	Springs	363
A	<i>Catchment and storage tank design</i> (J.M. VOUILLAMOZ, J.H. LAHAYE)	363
	1 Spring catchments	363
	1.1 <i>Flow measurement</i>	363
	1.2 <i>The hydrogeological context</i>	363
	1.3 <i>Spring catchments</i>	364
	1.4 <i>Equipping springs</i>	367
	2 Storage tanks	368
	2.1 <i>Tanks on spring catchments</i>	368
	2.2 <i>Tanks with gravity network</i>	369
	2.3 <i>Tanks in pumped systems</i>	370
	2.4 <i>Rainwater-catchment tanks</i>	370
	2.5 <i>Tanks for run-off catchment</i>	371
B	<i>Field examples</i> (J.M. VOUILLAMOZ, J.H. LAHAYE)	372
	1 Spring catchment	372

2	Water points	374
2.1	<i>Earthworks</i>	374
2.2	<i>Foundations</i>	375
2.3	<i>Reinforced-concrete slab</i>	375
2.4	<i>Plumbing</i>	378
2.5	<i>Masonry</i>	378
2.6	<i>Constant-level channel</i>	380
2.7	<i>Drainage channel</i>	381
11	Gravity distribution systems	383
A	<i>System design and construction</i> (O. STOUPY, J.M. VOUILLAMOZ, E. DELORME)	383
1	Feasibility study	384
1.1	<i>Drawing up the distribution plan</i>	384
1.2	<i>Rapid topographic survey</i>	387
1.3	<i>Technical verification</i>	387
2	Detailed survey	388
2.1	<i>Topographic survey</i>	388
2.2	<i>Hydraulic design</i>	390
2.3	<i>System design</i>	395
3	Construction of the system	402
3.1	<i>Header tanks and break-pressure tanks</i>	402
3.2	<i>Storage tank</i>	404
3.3	<i>Pipes</i>	404
3.4	<i>Tapstands</i>	417
B	<i>Field examples</i> (T. SUTTON, J. ROMAGNY, J.M. VOUILLAMOZ)	420
1	Gravity-flow water systems on spring catchments	420
1.1	<i>Planning</i>	420
1.2	<i>Human and financial resources</i>	421
1.3	<i>Example of the Ban Houn system</i>	422
2	Emergency distribution systems from boreholes	434
2.1	<i>Implementation</i>	434
2.2	<i>Human and financial resources</i>	434
3	Emergency systems from rivers	435
3.1	<i>Implementation</i>	435
3.2	<i>Example of the Aswha system</i>	437
12	Water treatment (J.M. VOUILLAMOZ)	441
1	Treatment procedures	441
1.1	<i>Choice of procedures</i>	441
1.2	<i>Pre-treatment</i>	442
1.3	<i>Flocculation and sedimentation</i>	443
1.4	<i>Disinfection</i>	446
1.5	<i>Filtration</i>	450
1.6	<i>Aeration</i>	451
2	Chemical dosing	453

IV	SANITATION	455
13	Sanitation (V. ARROYO, H. SÉMIOND, F. GONZÁLEZ)	457
1	Introduction	458
1.1	<i>Sanitation as a global problem</i>	458
1.2	<i>The importance of sanitation</i>	458
2	Sanitation-related diseases and their control	459
3	Key elements for the implementation of an environmental sanitation project	460
3.1	<i>Importance of socio-cultural factors and of the community perception of sanitation</i>	460
3.2	<i>Sanitation promotion</i>	461
3.3	<i>Working modes and community participation</i>	462
3.4	<i>School sanitation and children's issues</i>	462
3.5	<i>Sanitation and groundwater contamination</i>	463
4	Excreta disposal	464
4.1	<i>Defecation in open areas</i>	465
4.2	<i>Dry latrines</i>	465
4.3	<i>Pour-flush latrines</i>	474
4.4	<i>Advantages and disadvantages of simple, VIP and pour-flush latrines</i>	482
4.5	<i>Composting latrines</i>	482
4.6	<i>Latrines for rocky and frozen ground, high groundwater levels and flood-prone areas</i>	488
4.7	<i>Excreta control in IDP or refugee camps</i>	489
5	Other environmental sanitation activities	493
5.1	<i>Personal hygiene structures</i>	493
5.2	<i>Grease traps</i>	496
5.3	<i>Surface-water drainage</i>	496
5.4	<i>Vector control</i>	497
5.5	<i>Management of solid waste</i>	500
14	Cholera (G. POUJOL, J.M. VOUILLAMOZ)	505
1	General	507
1.1	<i>Cholera vibrios</i>	507
1.2	<i>Clinical signs and symptoms</i>	507
1.3	<i>Contamination</i>	507
1.4	<i>Prevention of infection</i>	508
1.5	<i>Treatment</i>	508
1.6	<i>Vaccination</i>	509
1.7	<i>Natural immunity</i>	509
1.8	<i>Risks to personnel</i>	509
1.9	<i>Epidemics</i>	509
1.10	<i>Epidemiological factors</i>	510
2	Assessment of the situation	510
2.1	<i>Confirmation of reported cases, implementation of a surveillance system</i>	510
2.2	<i>Previous epidemics</i>	511
2.3	<i>Sanitary surveys</i>	511
2.4	<i>Cholera task force</i>	511
3	Intervention strategy	512
3.1	<i>Development of the epidemic</i>	512
3.2	<i>Sanitary strategy/actions</i>	512



4	Types of intervention	512
4.1	<i>Large cholera treatment centre</i>	512
4.2	<i>Small-scale cholera treatment centre</i>	513
4.3	<i>Attachment to local structures</i>	514
4.4	<i>Health Ministry support</i>	514
4.5	<i>Emergency actions</i>	514
5	Cholera treatment centre (CTC)	515
5.1	<i>Planning</i>	515
5.2	<i>Choice of site</i>	516
5.3	<i>Layout of a CTC</i>	517
5.4	<i>Water supply</i>	520
5.5	<i>Sanitary facilities</i>	521
5.6	<i>Shelters</i>	524
5.7	<i>Sanitary barriers</i>	524
5.8	<i>Management</i>	525
5.9	<i>Other structures and contexts</i>	530
6	Actions in the community	531
6.1	<i>Information and hygiene advice</i>	531
6.2	<i>Improving water quality</i>	531
6.3	<i>Examples of specific actions</i>	534
7	End of the intervention	535
7.1	<i>Disengagement</i>	535
7.2	<i>Evaluation</i>	536
7.3	<i>After the cholera response</i>	537
V HYGIENE PROMOTION AND COMMUNITY MANAGEMENT		539
15	Hygiene promotion (A. DE VICENTE, E. LICTEVOUT, B. LOPEZ)	541
1	Introduction	541
1.1	<i>What is hygiene promotion?</i>	541
1.2	<i>Why is hygiene promotion important?</i>	541
1.3	<i>The hygiene-promotion project cycle</i>	544
2	Needs assessment	544
2.1	<i>Preliminary Appraisal</i>	544
2.2	<i>In-depth assessment</i>	545
2.3	<i>Research techniques</i>	549
2.4	<i>Recruitment and training of the assessment team</i>	559
2.5	<i>Analysis of results</i>	560
3	Programme planning and design	561
3.1	<i>Setting Programme Goals</i>	561
3.2	<i>Selection of target practices</i>	562
3.3	<i>Selecting the target audience</i>	563
3.4	<i>Designing the message</i>	563
3.5	<i>Communication channels</i>	564
3.6	<i>Selection of communicators</i>	567
3.7	<i>Consolidation of the communication plan</i>	569
3.8	<i>Distribution of hygiene kits</i>	570

4	Monitoring and evaluation	571
4.1	<i>Monitoring</i>	571
4.2	<i>Evaluation</i>	572
5	Example: Laos	572
16	Water-supply management (F. GONZÁLEZ, A. DE VICENTE)	575
1	General objectives	576
2	Types of management	577
2.1	<i>Actors in charge of water-supply management</i>	577
2.2	<i>Context and management</i>	580
2.3	<i>Management by type of water-supply system</i>	583
3	Community-based management	587
3.1	<i>How does it work</i>	588
3.2	<i>Water committee</i>	589
3.3	<i>Repairer</i>	592
3.4	<i>Spre-parts network</i>	592
3.5	<i>Local authorities</i>	593
3.6	<i>Launching a community management system</i>	593
3.7	<i>Cost recovery</i>	596
VI	SPECIFIC INTERVENTIONS	603
17	Emergencies	605
A	<i>Camp installations</i> (J.H. LAHAYE, J.M. VOUILLAMOZ)	605
1	Selection and planning of sites	606
1.1	<i>Guidelines</i>	606
1.2	<i>Layout plan</i>	606
2	Emergency shelters	606
B	<i>Water trucking</i> (H. SÉMIOND, I. MARZAN, F. GONZÁLEZ)	609
1	Introduction	609
2	The operation	610
2.1	<i>Water tankers</i>	610
2.2	<i>Distribution</i>	611
3	Case studies	613
3.1	<i>Water trucking in camps</i>	613
3.2	<i>Water trucking in rural areas (pastoral and agro-pastoral communities)</i>	614
18	Therapeutic feeding centres (J.G. MOULIN, H. SÉMIOND, L. VERDENAL)	619
1	Introduction	619
2	Guideline and recommendations	619
2.1	<i>Guidelines</i>	619
2.2	<i>Recommendations</i>	619
3	Layout of a TFC	622
19	Ponds (H. SÉMIOND, J.P. VEYRENCHÉ)	625
1	Types of ponds	625
2	Community impluvium ponds: the example of Myanmar	626
2.1	<i>Feasibility study</i>	626
2.2	<i>Technical recommendations</i>	626
2.3	<i>Design example</i>	627
2.4	<i>Human and financial resources</i>	628

3	Pastoral run-off ponds, example from Ethiopia	629
4	Examples of water-collection systems	632
4.1	<i>Well beside the pond</i>	632
4.2	<i>Filtration</i>	633
ANNEXES (E. DROUART, F. GONZÁLEZ, J. LANCE, J. LAPEGUE, E. LICTEVOUT, A. OLIVIER, H. SÉMIOND, O. STOUPY, A. DE VICENTE, J.M. VOUILLAMOZ)		
1	Reference indicators	639
2	Calculation of indicators	643
3	Sphere assessment checklist	651
4	Project manager. Job description	655
5	Water- and sanitation-related diseases	659
6	Hydrology	669
7	Water quality and analysis	681
	<i>A Indicators not covered by WHO</i>	681
	<i>B Water point sanitary survey</i>	682
	<i>C Sampling procedures</i>	686
	<i>D DELAGUA kit</i>	687
	<i>E Water-analysis file</i>	688
8	Geophysics	691
	<i>A Equipment</i>	691
	<i>B Electrical summary files</i>	694
	<i>C Nomograms</i>	696
9	Pumping-test files	701
10	Protection of water resources	705
11	Drilling	709
	<i>A Drilling equipment</i>	709
	<i>B Drilling log</i>	717
	<i>C Development file</i>	718
	<i>D Borehole file</i>	719
12	Hydraulics and units of measurement	721
	<i>A Hydraulics</i>	721
	<i>B Units of measurement</i>	729
13	Water-treatment products files	733
14	Civil engineering (O. STOUPY, J.M. VOUILLAMOZ)	735

The chapters 1, 2, 4, 5A-B, 6, 8B, 13, 15, 16, 17B, 18 and 19, and the annexes 1, 2, 3, 4, 5, 7B-C-E and 11B-C-D are new.

The chapters 3, 7A, 8A-C-D and 9, and the annexes 8 have been updated and extended.

# Action contre la Faim

*Action contre la Faim* (formerly *Action Internationale Contre la Faim*) is an independent, apolitical non-governmental humanitarian organisation which, for the last twenty five years, has waged an unremitting war on hunger in crisis situations around the world.

Internationally recognised as one of the world's premier organisations in combating hunger, *Action contre la Faim* intervenes in humanitarian situations involving war, famine, natural disasters and other crises to bring help to displaced people, refugees and any other populations in danger. After the emergency is over, continuity of action helps affected people recover their independence through medium and long-term programmes. The prevention of disasters is also one of its objectives.

In order to increase its capacity for action and advocacy, *Action contre la Faim* developed an international network with the opening of *Accion Contra el Hambre* in Madrid and *Action Against Hunger* in London and New York. This network allows intervention in more countries, the pursuit of new areas of technical development and an enlarged human-resources potential.

From its four headquarters (Paris, London, Madrid and New York), and with its 350 international volunteers and 4 000 national staff, *Action contre la Faim* focuses on rapid, effective, and highly-targeted responses in all four areas intimately involved in the fight against hunger and malnutrition: nutrition, health, food security, and water and sanitation.

A parallel aim of the organisation is to bring the world-wide problems caused by hunger sharply into focus, to increase awareness of the fate of those civilian populations who are victims of discrimination and violence in famine-hit areas, to alert public opinion to the true causes of hunger and to prompt the international community to take action.

If you would like to become a volunteer, to become a member of the organisation, to help by organising a "race against hunger" in your area, to enter into partnership with the organisation by sponsoring one of our programmes, or simply to make a contribution, you can contact us at : [www.action-contrelafaim.org](http://www.action-contrelafaim.org)

## The Charter

*Action contre la Faim* is a non-governmental organisation. Private, non-political, non-denominational and non-profit making, it was set up in France in 1979 to intervene in countries throughout the world.

*Action contre la Faim's* vocation is to save lives by combating hunger, disease, and those crises threatening the lives of helpless men, women and children.

*Action contre la Faim* intervenes in the following situations :

- in natural or man-made crises which threaten food security or result in famine,
- in situations of social/ economic breakdown linked to internal or external circumstances which place particular groups of people in an extremely vulnerable position,
- in situations where survival depends on humanitarian aid.

*Action contre la Faim* intervenes either during the crisis itself, through emergency actions, or afterwards, through rehabilitation and sustainable development programmes.

*Action contre la Faim* also intervenes in the prevention of certain high risk situations.

The ultimate aim of all of *Action contre la Faim*'s programmes is to enable the beneficiaries to regain their autonomy and self-sufficiency as soon as possible.

*Action contre la Faim* respects the following principles :

#### INDEPENDENCE

*Action contre la Faim* acts according to its own principles so as to maintain its moral and financial independence.

*Action contre la Faim*'s actions are not defined in terms of domestic or foreign policies nor in the interest of any government.

#### NEUTRALITY

*Action contre la Faim* maintains a strict political and religious neutrality. Nevertheless, *Action contre la Faim* can denounce human rights violations that it has witnessed as well as obstacles put in the way of its humanitarian action.

#### NON DISCRIMINATION

A victim is a victim. *Action contre la Faim* refutes all discrimination based on race, sex, ethnicity, religion, nationality, opinion or social class.

#### FREE AND DIRECT ACCESS TO VICTIMS

*Action contre la Faim* demands free access to victims and direct control of its programmes. *Action contre la Faim* uses all the means available to achieve these principles, and will denounce and act against any obstacle preventing it from doing so. *Action contre la Faim* also verifies the allocation of its resources in order to ensure that the resources do, indeed, reach those individuals for whom they are destined. Under no circumstances can partners working together with or alongside *Action contre la Faim* become the ultimate benefactors of *Action contre la Faim* aid programmes.

#### PROFESSIONALISM

*Action contre la Faim* bases the conception, realisation, management and assessment of its programmes on professional standards and years of experience, in order to maximise its efficiency and the use of its resources.

#### TRANSPARENCY

*Action contre la Faim* is committed to respecting a policy of total openness to partners and donors and encourages the availability of information on the allocation and management of its funds. *Action contre la Faim* is also committed to providing guarantees of proof of its good management.

All members of *Action contre la Faim*, world-wide, adhere to the principles of this Charter and are committed to respect it.



I

# Programme development

# ACF intervention policy and strategy

<b>1</b>	<b>Global water and sanitation problem</b>	3	4.5	Definition of priorities	15
<b>2</b>	<b>Crises and humanitarian contexts</b>	4	<b>5</b>	<b>Intervention principles</b>	16
2.1	Typology of humanitarian contexts	4	5.1	A direct approach to populations	16
2.2	Humanitarian situations and their evolution	6	5.2	A response that depends on analysis	17
2.3	Mechanisms of response	8	5.3	Multidisciplinary analysis	17
2.4	Technical intervention and advocacy	9	5.4	Involvement of affected communities	17
<b>3</b>	<b>Water and sanitation programmes</b>	9	5.5	Understanding, respecting and integrating local factors	18
3.1	Programme objectives	9	5.6	Sustainable impact of activities	18
3.2	Intervention domains and activities	12	5.6.1	<i>A response adapted to the capacities and willingness of the communities</i>	18
<b>4</b>	<b>Intervention criteria</b>	13	5.6.2	<i>Appropriate and tested techniques</i>	19
4.1	General considerations	13	5.6.3	<i>Transfer of knowledge and handover</i>	19
4.1.1	<i>The concept of vulnerability</i>	13	5.7	Coordinating activities	19
4.1.2	<i>A broader analysis for humanitarian interventions, concept of vitalism</i>	14	5.8	Community strengthening	20
4.2	General criteria	14	5.9	Gender issues	20
4.3	Specific criteria	15	5.10	Capitalising on experience and analysis	20
4.4	Target population	15	5.11	Respect for the environment	20

## 1 Global water and sanitation problem

Access to water and sanitation is one of the major challenges for the 21<sup>st</sup> century. According to WHO (2004), 1.1 billion people across the world do not have access to safe water and 2.4 billion people do not have access to basic sanitation facilities (see Box 1.1). As a consequence every year around 4 million people, the majority of who are children, die from water and sanitation related diseases.

Water is not only important for public health, but also for general livelihoods: crop production (70 to 80% of all water used is for crop production), livestock production, industry, commerce and daily life depend on access to water. Water-supply conditions therefore affect health, hunger, poverty and community development.

This disastrous access to water and sanitation is due partly to a lack of infrastructure but also to poor management that creates waste, contamination and degradation of the environment. Water shortages may lead to tensions between individuals, communities or countries, which can evolve into conflicts. At the same time, the demand for water is increasing due to population growth, urbanisation (rural exodus) and industrialisation. Urbanisation has also created extremely poor sanitary conditions.

Most of these problems can be solved through comprehensive management of water resources and demand. Water is a finite resource that must be managed with a global vision that works at three levels: *international* to define rules to protect water resources and to avoid international conflicts; *national* to apply defined rules and to define national water-access policies; and *local* to develop local initiatives to ensure communities' water access. Box 1.2 introduces the main commitments of the international community regarding this issue.

### Box 1.1

Water & sanitation in the world (mainly from World Water Assessment, WHO & UNICEF, 2003).

#### *Limited access*

- 1 100 million people do not have access to safe water (drinking water).
- 2 400 million people do not have access to basic sanitation facilities (half of the world's population), the majority of who are in rural areas (80%).

#### *Consequences*

- 80% of disease in developing countries is related to water.
- 4 million people, the majority of who are children, die each year (more than 10 000 each day) due to diseases related to water, sanitation and hygiene.

#### *Aggravating factors*

- By the year 2025, water needs will be increased by 20% (mainly due to population growth, urbanisation & industrialisation).
- The reduction of water resources due to waste, erosion, desertification (global warming), overexploitation and contamination.
- The uneven distribution of water resources that leads to tensions between communities and countries for its control.

Conflicts, natural disasters, discrimination and marginalisation, *destruction*\* of the state and communities, and extreme poverty exacerbate sanitary problems and may lead to humanitarian crises.

The first objective of humanitarian assistance programmes is to protect and improve the lives of the people in these critical situations. In principle, the first interventions of a water and sanitation programme focus on coverage of the most basic and immediate needs, while at the same time seeking to reinforce and stabilise the foundations for development in the community, in a way that will reduce or eliminate the risks linked to these vulnerable situations. In addition, water programmes also try to work to establish peace and equity: community mobilisation through water supply and sanitation projects can be a means of creating social cohesion and removing tension.

## 2 Crises and humanitarian contexts

### 2.1 Typology of humanitarian contexts

Millions of people in the world find themselves in situations of crisis (displaced populations, marginalized populations, victims of conflict etc.), see Box 1.3. As a consequence, entire communities live in a state of extreme vulnerability and their survival is constantly threatened. Humanitarian programmes are implemented in situations where human dignity is not respected and where basic needs are not met.

Action Contre la Faim distinguishes five types of problem that may classically lead to humanitarian situations and that warrant intervention:

#### *Open conflicts*

This refers to any conflict (civil war, armed conflict between countries etc.) which has a strong impact on the way of life of populations and which jeopardizes their survival. The main consequences of such conflicts are:

- physical insecurity and persecution;
- the disintegration of state structures and services (electricity, sanitary infrastructure, hospitals etc.);

---

\* The word *destruction*, applied to social organisations (States, communities, etc.), means the loss of structure and social cohesion and therefore results in changes in function, relationships and capacities.

## Box 1.2

### International commitments regarding water and sanitation issues.

Over the last thirty years the United Nations has been especially conscious of the significant role that water and sanitation play in human development and it has set out to define some general plans for development:

In the conference of Mar de Plata in 1977, the United Nations declared the eighties as the International Decade of Water and Sanitation, with a clear objective: 100% world-wide coverage of safe water and sanitation.

In 1992, the Statute of Dublin defined 4 fundamental principles:

- Fresh water is a vulnerable and finite resource, which is essential for life, development and the environment.
- Development and management of water should have a participative focus, involving the users, and those responsible at all levels, in the management plans and the politics of water.
- Women play a fundamental role in the provision, management and safekeeping of water.
- Water has an economic value in every aspect and has to be recognised as an economic good.

In the Forum of The Hague in 2000, an attempt was made to establish an international policy for water under the name of World Vision of Water. This policy developed three sectors: water for people, water for food and water for nature. The principal theme, which the document develops, is the integrated management of resources. One of its most important premises is that communities decide their own level of access to safe water and the hygienic conditions for healthy living, as well as the economic activities for which they use the water, and that they organise themselves to accomplish them. The most controversial recommendation is that a price must be placed on the total cost of water services (and it recommended doing so through the users).

In 2001, Koffi Annan, Secretary General of the United Nations, recognised that access to water is a fundamental human need, and as such, a basic human right. Water is necessary for human dignity.

The Kyoto Forum in 2003 focused on solutions and perspectives for the future, and the two main debates were private versus public management, and the accomplishment of the Objectives of the Millennium, which aim is to halve the number of people without access to safe water and sanitation by 2015.

Some NGOs have criticised the World Water Forums' initiatives because of their technocracy, lack of transparency, and scant acknowledgment of the understanding and experience of local people (though in Kyoto, there was good participation from local organisations), and mainly because they support the World Bank strategy on the privatisation of water, itself criticised for its very commercial vision, that gives little importance to development concerns and the situation of vulnerable communities.

The Sphere Project was launched in 1997, and reviewed in 2004, by a group of humanitarian NGOs and the Red Cross and Red Crescent movement, who framed a Humanitarian Charter and identified Minimum Standards to be attained in disaster assistance. The Charter describes the core principles that govern humanitarian action and reasserts the right of populations affected by disaster, whether natural or man-made (including armed conflict), to protection and assistance. It also reasserts the right of disaster-affected populations to life with dignity.

The 'Academie de l'eau' (a French NGO) also created the '*Charte Sociale de l'eau*' (the 'Social Charter for Water'), in which they summarise tools and concrete actions arising from the diverse experience of community management of water.

- the sudden loss of means of subsistence/livelihoods (commercial exchanges, market access, agricultural activities etc.);
- the weakening of internal mechanisms of regulation;
- the displacement of populations inside and/or outside of the country.

### *Natural disasters*

This refers to the occurrence of any natural phenomenon which jeopardises the lives of populations. These phenomena can be sudden (e.g. earthquake or flood) or gradual (e.g. drought). Some disasters are foreseeable (e.g. hurricanes), others are completely unpredictable (e.g. earthquakes).

### Box 1.3

#### Global picture of affected people.

- There are more than 12 million refugees in the world (ACNUR, 2002).
- There are more than 5 million internally displaced people in the world (ACNUR 2002).
- Approximately 608 million people were affected by disasters in the year 2002 (IFRC 2003).
- 842 million people (almost 800 million in developing countries), or 15% of the world's population, are undernourished, consuming less than 2 000 kilocalories per day (FAO 2003).

#### Consequences are:

- the sudden loss of means of subsistence/livelihoods (commercial exchanges, market access, agricultural activities, sanitary infrastructure etc.);
- the weakening of internal mechanisms of regulation;
- the displacement of populations inside and/or outside of the country.

#### *Post-crisis*

This refers to the time period following a serious crisis, be it man-made or natural. The populations affected are no longer subject to the immediate threats of the crisis, but must now deal with the resulting consequences and challenges: returning home after having been displaced, recovering lost goods and means of production etc. The powers in place are often unable (or unwilling) to help people recover their self-reliance, and must face their own problems of restructuring.

#### *Destructuration*

A country is in a state of destructuration when there is no officially recognized government, or when the government does not meet its responsibilities towards the population. This can be due to a lack of capacity (financial, structural, legitimacy issues etc.) within the state apparatus, or because of specific political actors who are either too uninterested or too self-seeking to bring the state's capacity to bear. At the same time, the international community doesn't recognise the absence of a state and act accordingly. As a consequence, people are left to themselves. When such is the case, violence usually becomes widespread and social services (construction, maintenance, management of sanitary infrastructure etc.) are at a minimum. In many cases state disintegration leads to community disintegration that prevents people from coping with their traditional means.

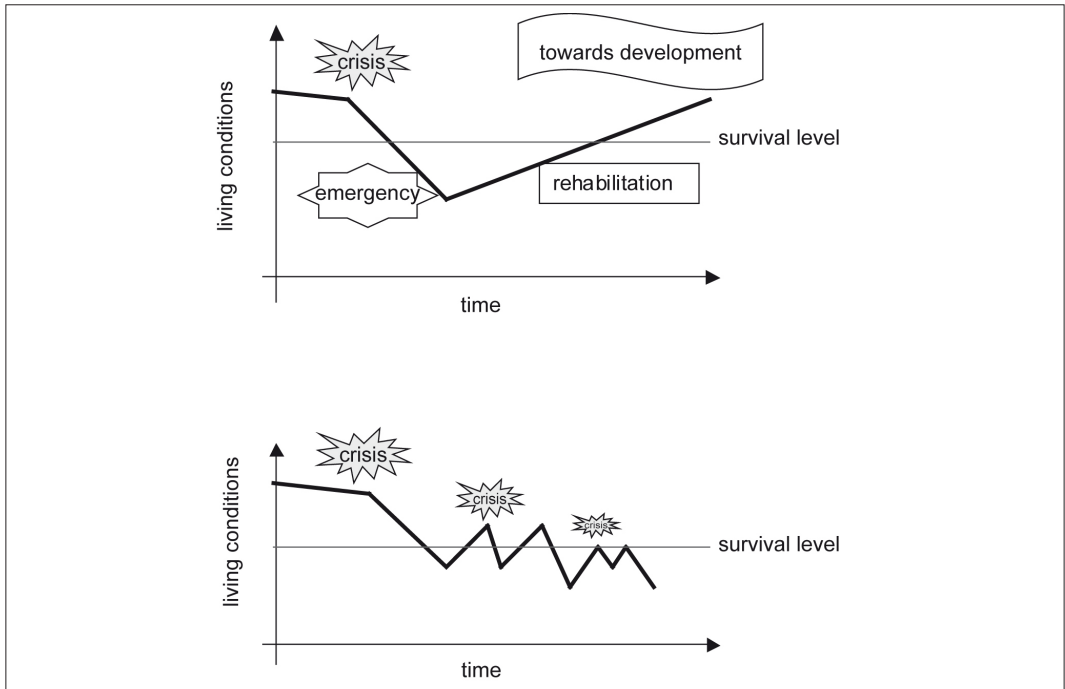
#### *Discrimination*

This refers to a country where communities or sections of the population suffer from discrimination along social, cultural, ethnic, religious or racial lines. This discrimination can be the result of policies (active or passive) implemented by a government (usually a strong state) but also by communities or groups themselves. The consequences for people discriminated against can be many:

- physical and moral persecution (e.g. forced displacement);
- blockage of internal mechanisms of regulation;
- exclusion from all types of development policy.

## 2.2 Humanitarian situations and their evolution

Not all the situations described above lead to humanitarian crises, and the consequences of a disaster or of a context favourable to crisis depend on the type and level of vulnerability of the affected populations (see Figure 1.3). These conditions determine the severity and impact of each event. For example, hurricanes of the same intensity will cause much greater loss and more damage in Central America than in Florida, principally due to the weakness of preparedness policies and local capacities in Central American countries. In another example, the year following the Iraqi war in 2003 did not lead



**Figure 1.1 Evolution of humanitarian situations.**  
**A: continuum model. B: contiguuum model.**

to an acute humanitarian crisis as previously feared. The level of development and internal structure of the country before the conflict allowed it to deal with the losses of the state and with local conflicts.

Analysis of the situation allows consideration of threats and vulnerabilities that may lead to a crisis and therefore decision on, and design of, an intervention. Section 4 and Chapter 2 develop the determination of criteria for intervention.

Crisis situations are usually complex and characterised by the interaction of various factors: natural catastrophes and/or human conflicts are added to various socio-economic and structural problems. The resulting compounded effects are often of the greatest magnitude. A crisis can initially arise from a sudden (quick-onset) occurrence (e.g. war, flooding) or via a slow and gradual (slow-onset) process (e.g. economic disruption or drought). Following its original manifestation, a crisis can then further evolve according to two possible models as explained below.

If a crisis consists of a single event, once that event is over and the more urgent needs are covered, one can move on directly from an emergency phase to a recovery phase. In such a case, the aim is to return to a state of normality similar to that prior to the crisis. This is called the *continuum model* (Figure 1.1A), and it has traditionally been used in the humanitarian community to describe the linear evolution of a crisis and response mechanisms corresponding to each phase: emergency, rehabilitation and development once the situation has recovered. These phases are reflected in the strategies and policies of many humanitarian organisations (donors and NGOs).

However, the reality is much more complex. Crises do not follow single evolutionary lines; the causes and aggravating factors are diverse, and situations may follow a succession of emergency phases and recovery phases, leading to cyclical crises. Populations must then face increasing levels of insecurity and socio-economic hardship. On the other hand, the situation prior to the event is not always a good model for recovery and it may be necessary to set other goals.

In recognition of this complex reality, the *contiguum model* was later developed (Figure 1.1B). This model incorporates the idea that in the same context, different levels in the response can coexist (the population is not affected uniformly by the crisis), and it emphasises the idea that in the majority of cases, the evolution of a situation is not linear (special attention needs to be paid to cyclical crises). This puts the concept of an 'emergency' in a much wider framework that recognises importance of the lack of organisational capacity, and reinforces the approach of disaster preparedness and risk management.

## 2.3 Mechanisms of response

The mechanisms of response are various and the strategy of any intervention includes several different kinds of response. Nevertheless, these responses can be classified as follows:

### *Emergency responses*

The main objective is to guarantee the *survival* of people facing a crisis, meeting basic needs (i.e. the most urgent). The response must be swift and effective, focusing on short-term vulnerability reduction. Typically, following an emergency response, the general situation will still be fragile, and a strong dependency on outside help will exist. Emergency responses are mainly appropriate in cases of open conflicts and natural disasters.

### *Capacity-building and rehabilitation responses*

The main objective is to help provide or restore people's livelihood and reduce dependence on external aid. Such interventions focus on the rehabilitation of social structures as well as the rehabilitation of infrastructure. In many cases, simply repairing material and social damage is not sufficient, as conditions prior to the disaster were not adequate. The response mechanisms need to be adapted to more self-reliant models and focus their objectives on the improvement of basic living conditions and the reduction of the major vulnerabilities faced in the medium term. This is achieved by providing a complete coverage of needs via self-reliant systems and so implies the participation and the empowerment of local structures and communities, as well as national institutions, in order to guarantee sustainability. They are appropriate where the situation is still fragile but where there is not as great a threat to life as in post-crisis, destructureation or discrimination situations.

### *Long-term interventions*

These focus on structural problems, and the principal objective is the reinforcement of the existing local capacity, with the goal of improving the living conditions of the communities in a sustainable way, and respect for their rights. The participation of the communities concerned, in the definition and implementation of programmes, is central to this approach. These programmes focus on the reduction of vulnerability in the long term. External support is kept to a minimum, and implementation is mainly done through local partners. These responses are appropriate in cases of post-crisis, destructureation and discrimination.

### *Disaster-preparedness and risk-management programmes*

These seek to reduce the impact of disasters through reducing communities' vulnerabilities and reinforcing their capacity for response. It includes:

- *Prevention*: measures and actions to avoid or remove risk (e.g. soil conservation, dam construction and earthquake-proof constructions).
- *Mitigation*: measures and actions to reduce or decrease risk; increasing the capacities of communities and decreasing their vulnerabilities (e.g.: institutional capacity-building, disaster education and awareness raising, legislation and planning etc.).
- *Preparedness*: measures for planning, organising and facilitating warning systems, search and rescue, emergency response and rehabilitation in case of disaster; strengthening the capacity of local actors to respond to disasters (e.g. community contingency plans).

Disaster preparedness is appropriate when vulnerability is high and a strong likelihood of disaster exists. It can form part of emergency, rehabilitation and development interventions, but has a long term approach.

$$\text{Risk} = \frac{\text{Threat} + \text{vulnerability}}{\text{Response capacity}}$$

*Note.* – In principal, the affected population should always be closely involved in the assistance activities. However, even in some long-term projects, direct implementation with little or no involvement of the affected population may be required for technical or contextual reasons.

## 2.4 Technical intervention and advocacy

Hunger, and humanitarian crises, may have a variety of causes: political, economic and natural, as presented in Section 2.1. Most of the humanitarian crises of the late 20th and early 21<sup>st</sup> centuries have had a political component resulting from a failure within the political system, just as they may have stemmed from a lack of concern by key actors, or by a blatant disregard for human rights.

As a consequence, effective humanitarian response often implies intervening both through technical interventions in the field (including infrastructure building, education and community strengthening, and institutional support such as involvement in national water policy development, as Action Contre la Faim did in East Timor etc.), to meet needs created by the crises (see Section 3.2), but also through advocacy in order to fight against the political causes of the humanitarian situation.

Advocacy aims to act on the underlying causes (often political and economic) of a crisis by bearing witness and highlighting a state of affairs that is unacceptable in humanitarian terms, with the objective of creating a level of public awareness and reaction that leads to pressure on policy makers to improve the situation. Examples of activities carried out include the collection of information (identification underlying political and economical causes), awareness campaigns, victim-protection programmes, institutional lobbying, and defence of human rights, including access to water (see Section 3.2).

# 3 Water and sanitation programmes

Action contre la Faim's main objective is to *fight hunger* and assist *populations faced with life-threatening situations*.

Water is essential for life and is very often a priority for threatened communities; in addition, water and sanitation factors are part of the underlying causes of malnutrition as presented in the Figure 1.2.

## 3.1 Programme objectives

The global objective of water and sanitation programmes is to *guarantee access to water and sanitation that is essential to survival and socio-economic development*. In many programmes the main concerns are sanitary risks and in these cases the objective is specifically focused on *the reduction of diseases related to water and poor sanitary conditions*.

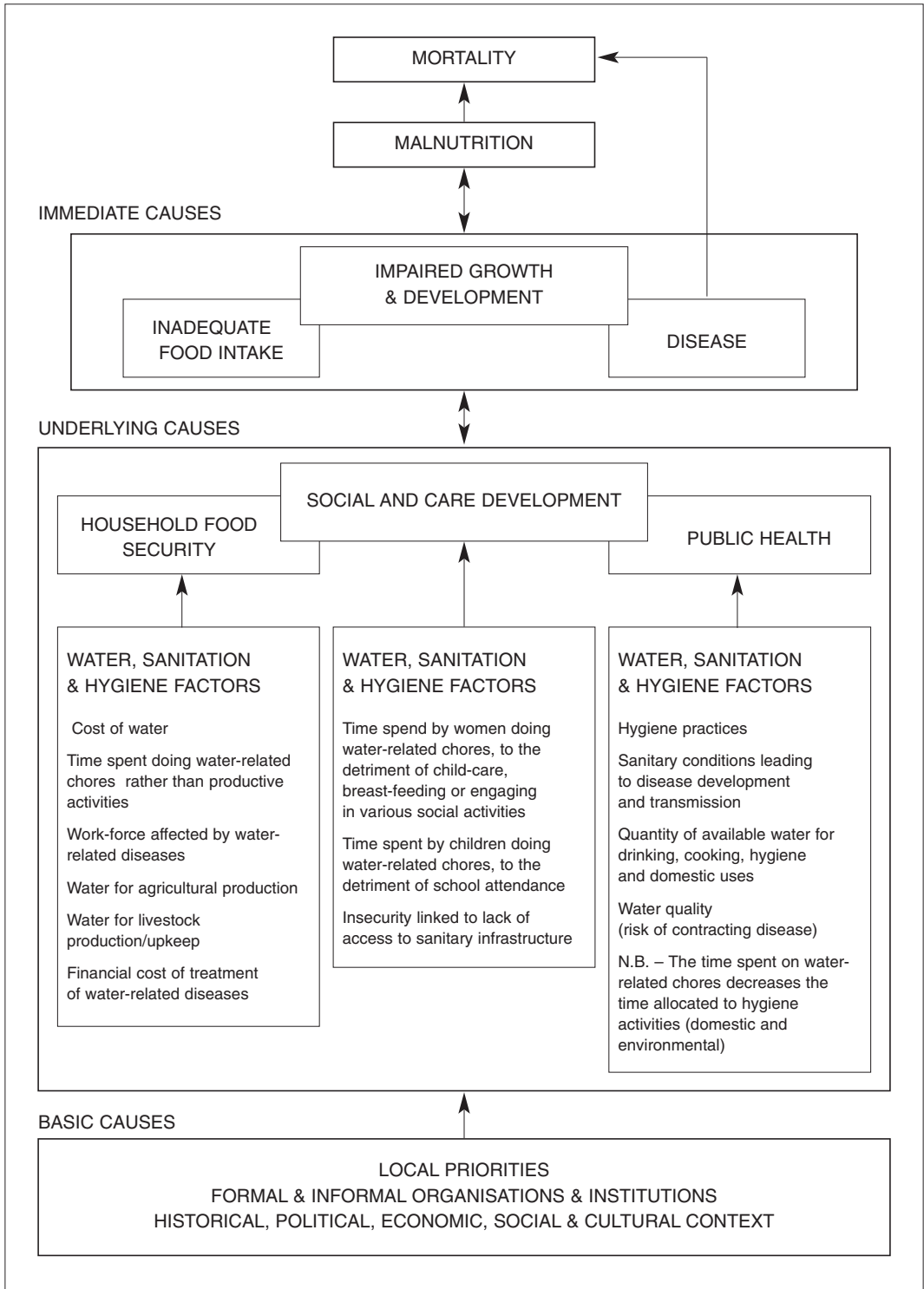
This global objective can involve three aspects:

### 1) *Covering the minimum requirements necessary for life*

When a serious threat to human life exists it is necessary to meet the minimum needs for survival, i.e. a *minimum access to water and vital sanitation structures*.

In each situation it is necessary to carry out a specific analysis to decide which minimum standards and reference indicators will be used. The Sphere project established a set of key indicators as a guideline, serving as reference in emergency situation (see Box 1.4 and Chapter 2). Action Contre la Faim was involved in writing the first two versions of the Sphere handbook.





**Figure 1.2: Integrated Framework showing the contribution of water and sanitation factors to the underlying causes of mortality and malnutrition (adapted from UNICEF, 1990).**

#### Box 1.4

##### The Sphere project.

The Sphere project is a global and interactive definition of standards designed for use in *disaster response*, and may also be useful in disaster preparedness and humanitarian advocacy. It is applicable in a range of situations where relief is required, including natural disasters as well as armed conflict.

It is designed to be used in both slow- and rapid-onset situations, in both rural and urban environments, in developing and developed countries, anywhere in the world. The emphasis throughout is on meeting the *urgent survival needs* of people affected by disaster, while asserting their basic human right to life with dignity.

Sphere handbooks includes specific points to consider when applying the standards and indicators in different situations, guidance on tackling practical difficulties, and advice on priority issues. They may also include critical issues relating to the standard or indicators, and describe dilemmas, controversies or gaps in current knowledge. See Chapter 2, Section 1.2 for more details.

### 2) *Reducing the risk of the spread of water, sanitation and hygiene-related diseases*

In developing countries, 80% of disease is related to water and approximately 2 billion people die each year because of diarrhoeal water and sanitation-related diseases (WHO 2003). For Action Contre la Faim, water has to be considered in a broad public health sense, to include general sanitary conditions and hygiene practices, mainly responsible for water contamination (faecal contamination) and pathogen development (e.g. malaria), see Figure 1.2.

The main water, sanitation and hygiene-related diseases are presented in Chapter 2, Section 2.2.

Action Contre la Faim's water programmes normally integrate water supply, sanitation, local capacity building, and hygiene and environmental promotion.

### 3) *Guaranteeing access to water as a necessary resource for food security and socio-economic development*

The means of survival and development for many communities are tightly linked to the availability of water resources (see Figure 1.2, impacts on household food security).

This dependence on water is particularly true for many rural communities who rely on agriculture and livestock production. For those communities these production activities depend mainly on suitable access to water through irrigation systems or livestock water points. In arid and semi-arid land (ASAL) regions, where livelihoods are chronically affected by droughts that cause disruption of the economic system, the construction of appropriate water systems and the training of communities in water-resource management can significantly decrease the vulnerability of rural populations to water shortages.

Lack of access to water also has a strong impact on the household economy, as the cost of water is an important part of many families' budgets (particularly in urban and peri-urban areas). For example, in Haiti, after the floods of December 2003 that destroyed the water-supply network of Port de Paix, and the lack of capacity of the government, that had just fallen, to carry out its rehabilitation, the price of water multiplied by five and became a large part of the daily family budget. The economic impact of lack of access to water can be also directly linked to the water-related chores that consume time and energy (mainly for women and children), instead of productive or educational activities. The problem is particularly acute in the remote areas of ASAL regions where Action Contre la Faim often observes several hours dedicated daily to water collection during the dry season, or in urban areas where queuing can consume a lot of time.

Water-related diseases also affect food security as well as economic development; sick people represent a loss of working capacity, and the cost in terms of drugs and treatment (even traditional) has an impact on the family budget.

Improving access to water means that families have easy access to infrastructure that supplies water in sufficient quantities. The focus is on local capacity building in order to guarantee the sustainability of this access.

*Note.* – Water and sanitation projects usually have a positive impact on the social and care environment, see Figure 1.2.

## 3.2 Intervention domains and activities

Activities can be grouped into different intervention domains as presented in Tables 1.I and 1.II.

**Table 1.I: Intervention domains and activities.**

Domains	Activities	Domains	Activities
Context analysis and studies	<ul style="list-style-type: none"> <li>• Socio-economic studies related to water</li> <li>• KAP surveys</li> <li>• Evaluation of existing and potential water resources</li> <li>• Search for new water resources</li> </ul>	Solid waste management	<ul style="list-style-type: none"> <li>• Solid-waste awareness</li> <li>• Refuse pits</li> <li>• Refuse collection</li> <li>• Recycling</li> <li>• Medical-waste management</li> </ul>
Water supply	<ul style="list-style-type: none"> <li>• Construction / rehabilitation of water points:               <ul style="list-style-type: none"> <li>– open wells, boreholes</li> <li>– springs</li> <li>– river / lake catchment</li> <li>– rainwater catchment and ponds</li> </ul> </li> <li>• Conservation of water sources</li> <li>• Reforestation</li> <li>• Systems for agriculture and livestock</li> <li>• Installation of water-extraction systems:               <ul style="list-style-type: none"> <li>– manual (e.g. rope and bucket)</li> <li>– gravity</li> <li>– handpumps, motorised pumps</li> <li>– solar systems</li> <li>– wind powered systems</li> </ul> </li> <li>• Water-quality analysis and monitoring</li> <li>• Water treatment</li> <li>• Distribution and storage</li> </ul>	Vector control	<ul style="list-style-type: none"> <li>• Risk analysis</li> <li>• Vector-related hygiene awareness</li> <li>• Mosquito-net distribution</li> <li>• Insecticides, rodenticides and disinfection</li> <li>• Fly traps</li> </ul>
Excreta disposal	<ul style="list-style-type: none"> <li>• Promotion of excreta disposal</li> <li>• Construction / rehabilitation of latrines</li> <li>• Composting</li> <li>• Sewerage systems</li> <li>• Sewage treatment</li> </ul>	Hygiene promotion	<ul style="list-style-type: none"> <li>• Construction / rehabilitation of hygiene structures:               <ul style="list-style-type: none"> <li>– showers</li> <li>– laundry areas</li> <li>– hand-washing facilities</li> </ul> </li> <li>• Hygiene kits distribution</li> <li>• Hygiene education</li> <li>• Transmission routes for diseases and measures to avoid them</li> <li>• Basic hygiene habits:               <ul style="list-style-type: none"> <li>– use of water</li> <li>– proper use of latrines</li> <li>– hygiene and food</li> </ul> </li> </ul>
Run-off and wastewater disposal	<ul style="list-style-type: none"> <li>• Drainage systems</li> <li>• Protection of banks</li> <li>• Wastewater drainage and treatment</li> </ul>	Knowledge transfer and training	<ul style="list-style-type: none"> <li>• Strengthening of local structures and training</li> <li>• Water and sanitation committees set-up</li> <li>• Data collection and transfer of information</li> <li>• Water policy development</li> </ul>
		Risk management	<ul style="list-style-type: none"> <li>• Prevention</li> <li>• Mitigation</li> <li>• Preparedness</li> </ul>

**Table 1.II: Activities linked to advocacy.**

---

Advocacy in water and sanitation programmes can be developed at three distinct levels:

*At the individual level*

Information on rights\*

Promotion of community mobilisation in order to help people claim their rights\*

*At local and national levels*

Informing relevant people of the problems

Informing relevant people of rights\*

Sensitisation regarding the situation and the possible solutions

*At the international level, and in developed countries*

Diffusing information regarding crisis

Presenting viable solutions to crisis in order to show that solutions exist

Actively involving the international community and political stakeholders; heightening their sense of responsibility

---

\* Claiming the right of access to water and basic sanitation is directly linked to defending the right to life. Meeting this right requires providing infrastructure and systems that allow the communities to live a dignified life, but also requires denouncing situations that prevent communities or people from enjoying this right.

---

## 4 Intervention criteria

### 4.1 General considerations

#### 4.1.1 THE CONCEPT OF VULNERABILITY

Vulnerability concerns the fragility of a group / person in an adverse context. The key elements that define the degree of vulnerability are the exposure to risks and the capacity to cope with these risks.

Globally, the level of vulnerability of a household/individual is determined by the risk of failure of the coping and reaction strategies when faced by a crisis. Vulnerability of a household can thus be defined as an imbalance between the resources required and those available, and an insufficiency of 'capital' assets to respond to a situation. It refers to the entire range of factors that place people in danger, the degree of vulnerability for an individual, a household, or a group of people being determined by their exposure to risk factors and by their ability to confront crisis situations and to survive them.

For a given household, population or region, this means the combination of:

– the exposure to different *hazards* or events placing the population at risk;

– and the potential *capacities / coping mechanisms* which could be applied to face that risk, anticipate it, resist it, and recover.

The crises/events to which populations are exposed are the circumstances and the conditions over which they have no direct control and which present a risk to their normal functioning. They could be climatic or environmental disasters (earthquakes, floods, droughts etc.), poverty (leading to risky life conditions: precarious housing, poor diet, unsanitary conditions, limited access to education etc.), or social or political conflict (war, moral prejudice, racism, ethnic tension, dictatorship etc.). Like capacities, vulnerabilities can be distinguished according to their physical, social, mental, or spiritual characteristics.

Vulnerability often also involves the degradation of the social and/or natural environment: frequently, vulnerable homes can no longer manage a balance between basic needs over the short term (survival) and their means of existence (livelihood) over the long term.

#### 4.1.2 A BROADER ANALYSIS FOR HUMANITARIAN INTERVENTIONS, CONCEPT OF VITALISM

During the 1990s, there was criticism of humanitarian agencies for providing assistance without taking into consideration the social or political character of conflict-affected populations, thereby reducing human beings only to the vital physiological functions they share with other animals. Focusing on this principle of life as such, humanitarian actors were criticised for giving in to *vitalism*. In concrete terms, the suggestion was that humanitarian assistance should have been designed differently and should have been accompanied by a psycho-social approach to people affected by conflicts, focusing on dignity and human rights (e.g. right to justice).

Applying the same critique may be made of programmes with a ‘technical’ focus. Humanitarian interventions should not be designed only according to physiological criteria, without taking into consideration the social environment and balance of the group concerned. For example, most water-supply and sanitation projects are justified by bad public health indicators, and promote access to sanitary facilities as well as changes in hygiene practices. In the case of pastoral populations, most of the reasons for their bad sanitary environment are constraints inherent to the way of life of such a population, a way of life that usually results itself from adaptation to an arid environment. Any change in such a fragile equilibrium should be carefully introduced, analysing in depth the risks of social disintegration that changes could create, and responses must be closely adapted to those factors. In extreme cases, when negative impacts are too high in relation to the acuteness of needs, the benefit of intervention itself should be questioned.

## 4.2 General criteria

The main objective of humanitarian aid is to guarantee minimum conditions for the survival of populations faced with a crisis (mortality rate is therefore a key criterion for intervention, see Chapter 2).

Generally speaking, interventions are launched when:

- the survival of populations is threatened;
- local structures are unable to respond to needs and require emergency assistance;
- the crises are recurrent and are leading to a disintegration of the affected communities;
- the general state of under-development prevents populations from reaching minimum standards of living and human dignity;
- communities petition for assistance.

Figure 1.3 shows a theoretical example of how living conditions are affected by a crisis. The evolution depends on the initial vulnerability level of the different groups in the affected population (represented by the different lines), on the deployment of effective coping strategies and on the extent of outside assistance.

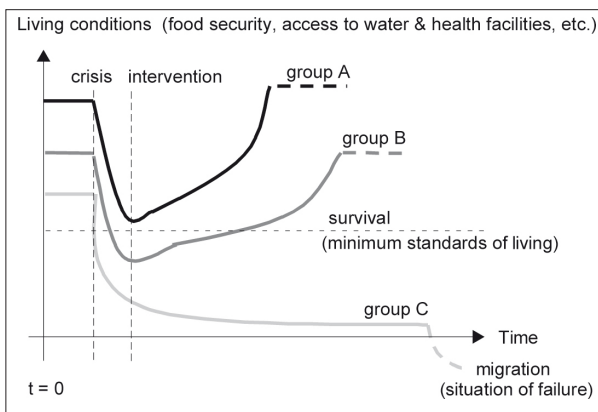


Figure 1.3: Crisis and living conditions.

### 4.3 Specific criteria

The main situations that justify the application of Action Contre la Faim 'water and sanitation' programmes are when:

- populations do not have (or no longer have) access to *sufficient quantities of water* to meet their drinking, domestic, agricultural and livestock needs;
- the *distance from water points* is limiting the socio-economic development of the community;
- the *quality and quantity of water* is such that it heightens the risks of epidemics and water-related diseases;
- the *environmental sanitation conditions* represents a health hazard (contaminated or unhealthy places favourable to the transmission of diseases such as malaria or scrub typhus that are linked to vectors, or diarrhoeal diseases, such as cholera).

*Standards, benchmarks and guidelines* (see Chapter 2 and Annex 2) permit a quick assessment of a situation in comparison to an established frame of reference; they must however be interpreted according to each specific context (see Box 1.4 and Chapter 2).

*The end or the hand-over of a programme* will depend on: achieving satisfactory coverage meeting the needs, achieving (or returning to) a state of self-reliance (at the level of the community or the local authorities), the presence of other actors, and the success or failure (blockage) of the programme.

### 4.4 Target population

Humanitarian organisations focus their work in areas where the needs are greatest, and where they find the most vulnerable populations. The decision of where to direct aid is made without consideration of race, religion or belief (see Action Contre la Faim Charter in ACF presentation). Target populations are:

- *displaced or refugee communities\**;
- *communities having lost their livelihoods* due to crisis (open conflict, natural disaster etc.);
- *ethnic or religious minorities* that are victims of the discriminatory behaviour of governments, other communities or groups;
- *isolated communities*, located in inaccessible rural areas, *excluded from development* efforts;
- *communities unable to maintain minimum standards of living and dignity* (e.g. in peri-urban areas).

Within these target populations, specific attention will be paid to the most vulnerable groups, normally: women, children, the elderly, people with handicaps, sick people (e.g. HIV/AIDS-affected people), and marginalized and poor groups.

### 4.5 Definition of priorities

The needs assessment (health status, sanitary survey, vulnerability and food-security study, infrastructure and resources inspection, hygiene knowledge and practices etc.) done prior to starting action, should give a global picture of the situation.

The analysis of the fulfilment of vital needs is systematic and can, for example, be expressed in number of litres of drinking water per person per day and, in the case of a pastoral affected population, in number of litres per animal per day (see Chapter 2).

---

\* In the case of displaced populations, as they usually mix with the resident populations, the actions carried out must be targeted not only at the displaced people: the residents' needs must also be assessed and taken into account in order to favour the integration of both communities and to avoid possible conflicts.

Human, financial and technical resources being limited, certain priorities must be set out to ensure minimum fulfilment of basic needs and a maximum impact of action taken:

- Vulnerable people and groups (see Section 4.4) must be attended to as a priority.
- It is better to cover the *entire population to basic standards* than to cover a limited population to high standards (both for public health or food-security issues).
- *Water quantity takes priority*: it is preferable to have an average quantity of average quality water than to have a small quantity of high quality water (without enough quantity of water, personal and domestic hygiene are compromised, as well as parallel activities such as gardening etc.).
- *Breaking the faecal-contamination chain* is a priority (e.g. managing human excreta in a camp) when sanitary risks exist.
- *The coverage of needs must be guaranteed in key places*: health centres and feeding centres, schools and public places.
- All other things being equal, *communities displaying motivation and willingness* should take precedence.
- All other things being equal, one should *intervene where local water resources permit an immediate response*.

## 5 Intervention principles

The contexts and modalities of water and sanitation interventions are many. Nonetheless, a certain number of principles must be respected during the project-management cycle.

These principles are designed to create a sense of responsibility in the aid worker (but also in all the actors involved in crisis management), who must be accountable to the affected population for their actions. The respect of these principles throughout the whole project cycle should guarantee the relevance, quality, effectiveness and sustainability of the intervention.

### 5.1 A direct approach to populations

Ensuring that interventions reach the target population in an appropriate way is part of the Action Contre la Faim Charter. This is essential, as it provides a measure of the success of the programme and enables an understanding of any obstacles from local, national or international groups or institutions.

In order to ensure a fair and effective intervention, a direct collaboration with the populations concerned is essential and allows programme staff to do the following:

- analyse contexts and define interventions while listening to the affected populations;
- find the best way of fitting the programme within the existing social dynamics and building partnerships;
- monitor the impact of the programme and avoid the obstacles that might divert the programme from its course.

Although the role of Action Contre la Faim is to work with and for a population, it is important to consider the local institutional capacity and its role in the medium and long term. Therefore, the implementation of programmes may take place with local organisations and state services; the involvement of these partners depends on their aims (political, religious etc.) and their working capacity. If these partners hinder reaching the objectives of the programme, it will then be advisable to develop an independent way of working in order to fulfil identified needs.

*Note.* – During the last decade, new contexts of intervention obliged humanitarian agencies to develop *remote-management* of interventions. This method of intervention is used in contexts where, for security reasons, permanent access to the field is not possible. Consequently, strict monitoring procedures must be implemented in order to guarantee impacts.



## 5.2 A response that depends on analysis

In order to understand and clearly define the nature of needs and their causes, and to define the most appropriate response to a given situation, analysis must be done, to understand the different determining factors.

This analysis, carried out both before and during the intervention, must take into account:

### *The context*

- The *factors relating to the crisis* (political, natural etc.).
- The *situation prior to the crisis* (conditions, resources, vulnerabilities, assets etc.).
- The current situation and the *available capacities* and *coping mechanisms* within the affected population.
- The context's possible evolutions.

### *The population*

- Local specificities and *socio-economic, cultural and religious constraints*.
- The nature of the population's needs and expectations.

### *The environment*

- The type of water resources available.
- The climate.

## 5.3 Multidisciplinary analysis

In order to reduce mortality and to fight effectively against malnutrition, it is essential to take into consideration all their potential determinants (see Figure 1.2). The analysis of the context and the identification phase (in particular, meetings with the population concerned) must involve multidisciplinary teams (for example, water and health and/or food security).

Action Contre la Faim takes an integrated approach to its interventions when appropriate. This integrated approach includes both *curative* and *preventive interventions* within the nutrition, food security, water and sanitation and health (primary care, mental health etc.) sectors. Examples of integrated approaches include water, sanitation and hygiene-promotion activities complementing primary-health projects, or irrigation and water supply for livestock being integral parts of food-security programmes.

An integrated approach does not signify that one organisation must develop a package of several kinds of activity, but that the actions identified as appropriate (from and around the needs of the population concerned) must be co-ordinated throughout all phases of the project. These actions can also be implemented by different actors.

## 5.4 Involvement of affected communities

The participation of the affected communities in the different phases of the programme is fundamental (identification of needs, implementation, monitoring and evaluation), since it guarantees the *relevance* and *sustainability* of actions in relation to needs.

Programmes must aim to have the maximum involvement of the communities concerned. Depending on the intervention context, the type of programme, the phase of the project and the community, the level of involvement varies from simple consultation to proactive participation in the project. A displaced community is usually in a precarious situation, having more or less lost everything, and sometimes it is difficult (or not relevant during the implementation phase) to convince people to participate actively in a project. On the other hand, a stable population should be more easily mobilised to involve itself in the project and its involvement could be a condition for external intervention.

Concerning the implementation phase, community participation can be done through direct contributions (money or material) to infrastructure construction or, more commonly, through physical



work. This reinforces the appropriation of the infrastructure by the community and therefore improves its management.

## 5.5 Understanding, respecting and integrating local factors

Many communities have a detailed knowledge of the potential of their physical environment to provide resources for production activities or for preventive and curative medicine (and of its potential to cause diseases). In general there is an understanding of the environment, not only in a physical sense but also in the sense of its relationship with social and spiritual factors. This holistic vision of the environment is embedded in many cultural beliefs and habits that affect the use of water and behaviour concerning sanitation (see example in Box 1.5).

The project has to determine how the community's beliefs, knowledge and management of the environment can be dealt with in a positive manner. The most important thing to keep in mind is *respect*. Instead of showing that a taboo or a belief is absurd because it is so in their own culture, staff should work on understandable and appropriate messages that show the causes of a problem and should seek an effective solution with the community. In cases where it proves more convenient to change a certain habit, respect should guide the way the necessary information and encouragement are provided to the community to raise awareness about the benefits of this change.

## 5.6 Sustainable impact of activities

Achieving a sustainable system is an issue that must be considered from the outset of the programme's definition.

During the first steps of an emergency the initial response must be quick and effective, and self-reliance is not necessarily an objective. However, once basic needs are met, the evolution of the response must be planned with long-term sustainability in mind. In order to achieve this, the factors that must be taken into account are:

- appropriateness of technology for the context and the population;
- quality of design and construction of installations;
- involvement of communities and local structures;
- capacity building and training (management, maintenance etc.).

To meet such conditions, care must be taken to understand and respect socio-cultural and economic factors, to use appropriate technology and to achieve a good transfer of skills.

### 5.6.1 A RESPONSE ADAPTED TO THE CAPACITIES AND WILLINGNESS OF THE COMMUNITIES

Taking into account the socio-cultural and economic characteristics of the community is a necessary condition for achieving a successful and effective project.

#### Box 1.5

##### Perceptions of clean and dirty.

The concepts of clean and dirty, and of pure and contaminated, are well developed in many religions and cultures. Besides the reference to a physical state, these concepts are spiritually important and have a central place in religious ceremonies. Consequently there is a need to be attentive when trying to pass messages. "Clean" can have very different meanings for the project promoters and for the community. It is crucial to examine the traditional understanding of cleanness and dirtiness, purity and contamination before starting to mobilise the community to participate in a sanitation project.

Indeed, technical decisions must be made according to criteria that are not only technical, but also social and cultural, and so the responses chosen must be appropriate to the way of life of the communities concerned.

In order to define a project, it is therefore necessary to:

- evaluate both the *willingness* and the *management capacity* of local communities; – respect *local religions, beliefs and taboos* (in relation to water, sanitation etc.) and adapt technical interventions accordingly;
- evaluate the human, technical, logistical and economic resources required and available for the maintenance of the installations;
- respect the social hierarchy and anticipate potential conflicts that could arise from the construction of water points (what is the purpose of the water point and who is meant to use it?).

## 5.6.2 APPROPRIATE AND TESTED TECHNIQUES

The use of technologies that are appropriate to the communities' socio-cultural and economic constraints (see Section 5.6.1), as well as the natural environment, is a pre-condition for the success of any project.

The use of techniques of proven effectiveness is the safest way to ensure that the response is both appropriate and sustainable.

However, there are instances when a perfectly appropriate solution is not available. In such cases, the project must be inventive and look actively into solutions designed for other contexts. This requires:

- a precise analysis of the needs and resources;
- a study of the solutions already deployed at the local level, as well as an evaluation of the necessary modifications;
- promotion, at the regional level, of techniques designed by both the local communities and other local stakeholders (South-South exchange).

## 5.6.3 TRANSFER OF KNOWLEDGE AND HANDOVER

From the onset its implementation, the project must allow for a gradual withdrawal of aid, with total withdrawal as the final objective. From the beginning it is important to clarify the different roles of the communities, the traditional authorities and political actors. Specific attention should be given to ownership, accessibility and management. Eventually the project will have to include an official handover of activities and infrastructure to a recognised and legitimate group.

Technical training and maintenance groups are an essential aspect which must go together with the implementation of the project. There is a distinction between training aimed at making operation and maintenance teams self-reliant from a technical point of view, and training of users. Training is carried out on-site, day-by-day, but training sessions are also planned, bringing together technicians and user-committee members (treasurers, plumbers etc.) in order to accumulate experience, publicise local successes, and allow all partners to benefit.

## 5.7 Coordinating activities

Coordinating the different stakeholders is crucial in order to maximise the value of the available resources, and must be maintained throughout the various phases of the project cycle, from definition to evaluation.

This coordination must include all concerned stakeholders: the communities concerned, local, traditional and administrative authorities, other organisations present (NGOs, United Nations, private sector etc.).

## 5.8 Community strengthening

Crises often lead to a breakdown of communities. Humanitarian aid must therefore seek to *reinforce social organisation and cohesion* through a communal approach to water management.

Community mobilisation and participation during the project, as well as water-point committees, is a way of achieving this objective. It must be handled in a way that is both participative and democratic, thus allowing for the promotion of these values.

## 5.9 Gender issues

During the project-definition phase, it is important to understand the role and status (specific vulnerability) of women within the community, as well as the part they will come to play within the project itself.

Where possible, women should be employed for the hygiene-promotion, sanitation, and water-management components of a project. As women are almost always responsible for children's education and housekeeping, their inclusion is a necessary element of the project.

Beyond this 'technical' aspect, favouring the active participation of women in project activities and in the building of committees has the added value of *strengthening their role* in the community.

## 5.10 Capitalising on experience and analysis

Implementing a project allows the gathering of a considerable amount of information, be it on the general context or on the methodologies and technologies employed. All this information is of great value to the communities, the local stakeholders and the various actors who may wish to operate in the area.

Consequently, the collection, analysis and sharing of information is invariably an objective of any programme. This involves:

- the systematic collection of trustworthy data;
- the use of databases to facilitate information management and analysis;
- the use of geographic information systems (GIS) for a clear and attractive analysis;
- capitalising on the working methodologies through notes and manuals;
- the sharing and promotion of the body of information gathered.

## 5.11 Respect for the environment

Projects always have a potential impact on the natural environment. Therefore, during each intervention, the environmental risks must be assessed and the impact should be minimised.

In every case, it is important to sensitise the affected community and other local stakeholders about the proper management of their water resources and the environmental risk factors.

It is particularly important to avoid the *over-exploitation* of aquifers: during the implementation of drilling or well-digging programmes, the available resources must be systematically assessed (through geophysical studies, pumping tests etc.). This helps determine the number of water points and appropriately size the pumping systems chosen. Gathering meteorological information is also essential. If there is a risk of exhausting underground water resources, alternative resources must be considered.

The creation of refugee or displaced people's camps generates a risk of *deforestation*, of *over-exploitation* and of *contamination* of resources (e.g. by refuse and faeces), and constant vigilance is required regarding these risks. Also, during the implementation of water-treatment projects, the disposal of sedimentation residues must be carried out far from water courses and surface-water bodies.

# Project management

<b>1</b>	<b>Management of water and sanitation programmes</b>	21	<i>3.1.3 Strategy analysis</i>	43
1.1	Project-cycle management	22	3.2 Planning phase	45
1.2	Guidelines and standards	24	<i>3.2.1 Logical framework matrix</i>	45
<b>2</b>	<b>Needs assessment and project identification</b>	25	3.2.1.1 Parts of the matrix	46
2.1	Objectives of needs assessment	25	3.2.1.2 Construction of the logical framework matrix	49
2.2	Water and sanitation-related diseases	27	3.2.1.3 Checking the logic of intervention	49
2.3	Assessment components	29	<i>3.2.2 Activity (work-plan) and resource scheduling</i>	49
2.4	Resources and means to do an assessment	31	3.3 Proposal writing	52
2.5	Information gathering	31	3.4 Project approval and financing	53
<i>2.5.1</i>	<i>Information-collecting techniques</i>	31	<b>4 Project implementation and monitoring</b>	53
	2.5.1.1 Participatory techniques	32	4.1 Planning	54
	2.5.1.2 KAP surveys	34	4.2 Staff management	55
<i>2.5.2</i>	<i>Types of information</i>	34	<i>4.2.1 Creating the team</i>	55
	2.5.2.1 General information	34	<i>4.2.2 The role of the project manager</i>	55
	2.5.2.2 Specific information on water and sanitation	35	<i>4.2.3 Labour relations and contracts</i>	56
2.6	Assessment in emergencies	38	<i>4.2.4 Special management tasks</i>	56
<i>2.6.1</i>	<i>Rapid appraisal</i>	38	4.3 Internal procedures	57
<i>2.6.2</i>	<i>Rapid assessment</i>	38	4.4 Security and safety awareness	58
2.7	Sanitary surveys	39	4.5 Community involvement	60
<b>3</b>	<b>Project design</b>	39	4.6 Management of information, lessons learned and reporting	60
3.1	Analysis phase	39	4.7 Monitoring	61
<i>3.1.1</i>	<i>Problem analysis</i>	40	<b>5 Evaluation</b>	62
<i>3.1.2</i>	<i>Analysis of objectives</i>	42		

## 1 Management of water and sanitation programmes

This chapter will focus on planning and implementing water and sanitation projects. In general, projects may be stand-alone or may be integrated into a more comprehensive programme where several projects contribute to one overall goal (water and sanitation projects can fit within health, food security, education or capacity-building programmes). Despite the difference in scale and nature of projects, there are aspects of sound project management that are universal. The components discussed here are adapted to the humanitarian context and, more specifically, to water and sanitation interventions.

This chapter is based on Project-cycle management and the Logical Framework approach. Project-cycle management involves an approach and a set of tools for designing and managing projects, which are used by most humanitarian agencies and donors. However, there are also agencies which are strongly critical of the use of these tools, as the stages of the cycle are not so neat in reality, and they merge and involve an iterative process. Also, project-cycle tools put too much emphasis on planning and appraisal, and too little on implementation or evaluation.

The Logical Framework approach is a set of useful tools for planning and managing a project. Its purpose is to provide a clear, rational framework for planning the envisioned activities and determining how to measure a project's success, while taking external factors into account (Introduction to the LFA, Adam Walsch, 2000).

Guidelines and standards are also necessary and complementary tools for preparing and implementing projects, and these are addressed in Section 1.2.

## 1.1 Project-cycle management

The project cycle describes the phases of a project from concept to completion (see Figure 2.1). The cycle is a progressive sequence which outlines information requirements, responsibilities and key decisions for each stage of a project.

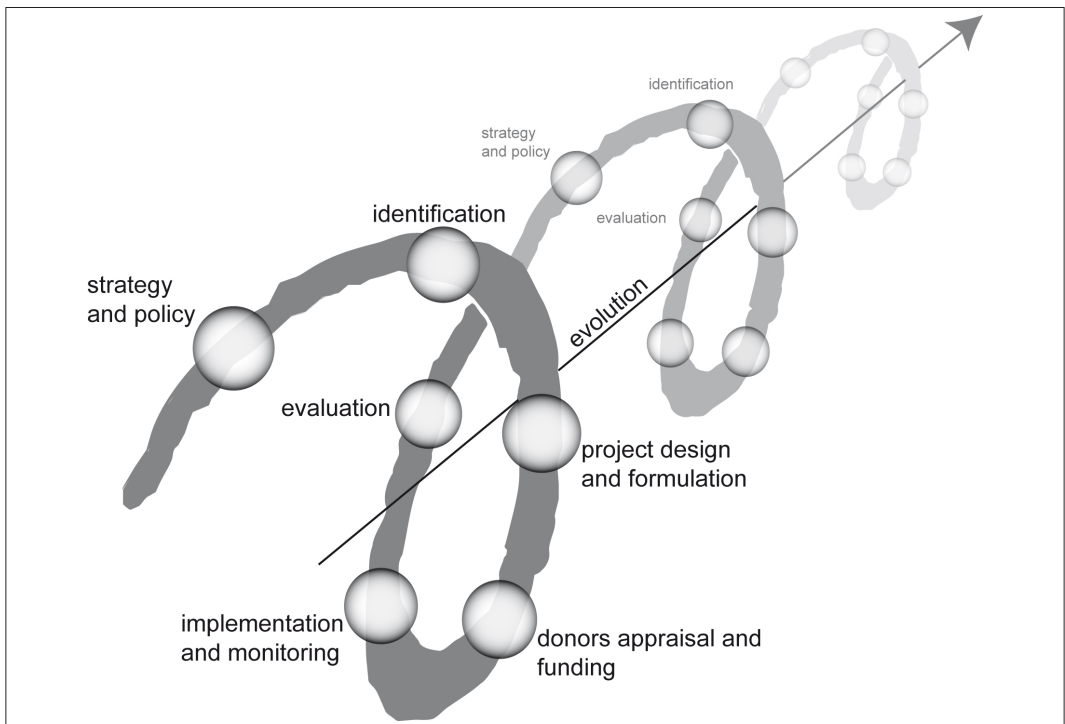
Project-cycle management is an iterative process in which the stages are not always discrete, and experience acquired during the development of the project serves to develop further stages and to define future projects.

There are six main phases in the project cycle.

### 1) *Strategy and policy*

Strategy and policy are the bases on which projects can be identified and prepared.

Implementing organisations and donors develop their own strategies which define principles, intervention criteria and methodologies. These strategies can be separate among organisations and developed by country or region, where national, regional and sector policies developed by governments and other agencies must also be taken into account. In this sense, it is important for implementing organisations and donors to work in partnership with governments and other stakeholders, contributing also to the definition of these governmental strategies and policies.



**Figure 2.1: The Project Cycle.**

Strategies should be periodically reviewed, updated and improved by taking project experiences and the changing operating environment into consideration.

## 2) *Project identification*

Identification of problems and analysis of the main options to address these problems are undertaken at this stage. Analysing the existing and potential capacities of various stakeholders and understanding the main characteristics of the context are required to create a well-developed project. This involves consultation with the intended beneficiaries, governments, NGOs and other stakeholders to ensure that needs are met and coordination is undertaken.

## 3) *Project design and formulation*

During this phase project ideas are developed, addressing technical and operational aspects. Once the main features are defined, the project is assessed for feasibility (whether it is likely to succeed) and sustainability (whether it is likely to generate long-term benefits for the beneficiaries). Projects should be assessed from technical, financial, economic, gender, social, institutional and environmental perspectives. The final steps of this phase are often the writing of a project proposal and its submission to potential funding agencies.

*Note.* – The separation of the project identification and project design and formulation phases is particularly important. Project preparation takes place in a social and political context, where expectations are raised and often-conflicting demands and aspirations must be reconciled. By adhering to the identification phase, the relevance of project ideas can be systematically established before the preparation process is too far advanced for the idea to be dropped. During the formulation phase, project ideas can then be fully developed with the knowledge that they are based on real beneficiary needs and are sufficiently ‘owned’ by the main stakeholders.

## 4) *Donors appraisal and financing*

Project proposals are examined by the funding agency, and a decision is taken on whether or not to fund the project.

## 5) *Implementation and monitoring*

Implementation of project activities is undertaken, with on-going monitoring of progress and feedback from beneficiaries and stakeholders. Adaptive management, or a continuous review and updating of operations in the context of the ever-changing situation, should be used. Even fundamental objectives may need to be modified in the light of any significant changes that may have occurred since earlier planning.

## 6) *Evaluation and evolution*

Achievements and lessons learned should be reviewed upon project completion. Evaluation findings are used to improve the design of future projects or programmes.

This chapter provides a general overview of the management of a project, but it should be complemented by the other chapters of the book.

Applying guiding principles and analytical tools and techniques within the structured decision-making process of the project cycle ensure that:

- *Projects are aligned* with agreed strategies and the needs of beneficiaries:
  - projects are linked to sectoral, national and implementing agency objectives;
  - beneficiaries are involved in the identification and the planning process from the earliest stage;
  - problem analysis is thorough;
  - objectives are clearly stated in terms of benefits to target groups.
- *Projects are feasible* in that objectives can be realistically achieved within the constraints of the operating environment and the capabilities of the implementing agency:
  - objectives are logical and measurable;

- risks, assumptions and implementing agency capabilities are taken into account;
  - monitoring concentrates on relevant targets.
- *Projects are sustainable:*
- factors affecting sustainability are addressed as part of project design;
  - previous evaluations building upon lessons learned are integrated into the design of projects;
  - beneficiaries are involved significantly through all the project-cycle phases;
  - methodologies and technologies are adapted to the specific situation;
  - local capacities and resources are utilised to the fullest.

## 1.2 Guidelines and standards

Standards and procedures for different aspects of the projects can be developed in specific guidelines as a support for designing and implementing projects. Guidelines can be set by a host of stakeholders (governments, donors, organisations, communities) at various levels (international, national, local, organisational). Implementing organisations should be aware of all relevant guidelines and utilise them to the extent that they are appropriate. Special attention must be paid during emergency responses, as normal standards may not be appropriate.

Different types of guideline can be used for different aspects of the project:

- standardised models and designs (e.g. type of latrine or water point);
- minimum requirements to attain (e.g. water quality or number of people per handpump);
- programme procedures (e.g. standard evaluation procedures).

Using guidelines can ensure that efforts are streamlined and simplified, and that it is easier to evaluate whether or not basic needs are met.

There are two main types of standard used for project management. One concerns reference values, designs etc. that are used as criteria for guidance and comparison (e.g. standard use of a specific handpump model in a particular region).

But *standard* also has the meaning of a level of service or resources necessary to cover the needs of a population (e.g. all the children in the schools should have access to enough clean water). Minimum standards in humanitarian projects are framed in this last sense and focus on coverage of the most basic needs.

Minimum standards should be complemented by quantitative and qualitative indicators. During the project identification phase, standards and indicators can be used to assess the needs of communities and to plan the intervention. For example, water demand can be estimated by comparing the quantity of water available per person per day with an expected indicator (i.e. X% of the population has Y litres per day less than the minimum requirement of 20 litres per person per day (l/p/d). Additional water supply should guarantee an extra of Z m<sup>3</sup> of clean water per day to meet the standard).

Some reference indicators for water and sanitation programmes in emergency and stable situations are included in Annex 1. Box 2.1 describes some key aspects for the use of guidelines and standards.

Two guidelines are commonly used in humanitarian water and sanitation interventions:

– The *WHO Guidelines for Drinking-Water Quality* ([www.who.int](http://www.who.int)) contains common reference values, and outlines the relationship between water quality and the risks to human health (see Chapter 12 and Annex 7).

– *The Sphere Project Handbook* ([www.sphereproject.org](http://www.sphereproject.org)) includes the *Sphere Humanitarian Charter* and *Minimum Standards in Disaster Response*, which set out what people affected by disasters have a right to expect from humanitarian assistance. The aim of the Sphere Project is to improve the quality of assistance provided to people affected by disasters, and to enhance the accountability of the humanitarian system in disaster response. Sphere covers various fields including: water and sanitation, nutrition, food aid, shelters and site planning, and health services. Donors, policy makers and institutions often systematically refer to Sphere in relief programmes. Each guideline is developed as follows:



### Box 2.1

#### Use of guidelines and standards.

Guidelines and standards must be considered as references to help in programme definition and implementation, and not as hard and fast rules. Guidelines are defined for common situations and may not be appropriate for all contexts. Each situation will require specific analysis to determine their relevance and use. It is always important to justify why set guidelines are used or not.

Not all the guidelines and standards have the same value. For water and sanitation humanitarian projects, priorities should be made to guarantee that minimum needs are met for survival, including:

- a minimum quantity of water per person;
- an appropriately determined number of people per latrine (along with other sanitation facilities).

The first priority is *to supply of a minimum quantity of water. Quality of water also becomes a major concern when major health risks exist.*

- *The minimum standards:* these are qualitative in nature and specify the minimum levels to be attained in the provision of water and sanitation responses (e.g. Minimum Standard 1 for water supply: *All people have safe and equitable access to a sufficient quantity of water for drinking, cooking and personal and domestic hygiene. Public water points are sufficiently close to households to enable use of the minimum water requirement.*).

- *Key indicators:* these are ‘signals’ that show whether the standard has been attained. They provide a way of measuring and communicating the impact, or result, of programmes as well as the process, or methods, used. The indicators may be qualitative or quantitative (e.g. *Average water use for drinking, cooking and personal hygiene in any household is at least 15 litres per person per day (see guidance notes 1-8).*).

- *Guidance notes:* these include specific points to consider when applying the standards and indicators in different situations, guidance on tackling practical difficulties, and advice on priority issues. They may also include critical issues relating to the standards or indicators, and describe dilemmas, controversies or gaps in current knowledge.

A common mistake in the use of Sphere is to consider the *key indicators* as the only reference without the consideration of the *minimum standard* and the *guidance notes* (for example, people often say that Sphere minimum standard for water supply is 15 litres per person per day but this is wrong: the minimum standard for water quantity and access is as written above; the key indicators can be more variable depending on the context, whereas minimum standards are intended to be universal). Programme objectives must be based on the *minimum standards* that express basic needs in a qualitative manner.

## 2 Needs assessment and project identification

### 2.1 Objectives of needs assessment

Any intervention or programme must be based on clear and well-defined needs. An assessment is the starting point of any project. It must be well planned and adequately resourced, with a clear description of how the assessment will be carried out (terms of reference).

The objectives of the assessment are:

- to understand the situation of the communities by identifying their needs and their problems;
- to understand the requirements and demands of these communities and how they understand their situation;
- to look at the resources and capacities available;
- to collect and analyse enough information to enable development of an effective plan.



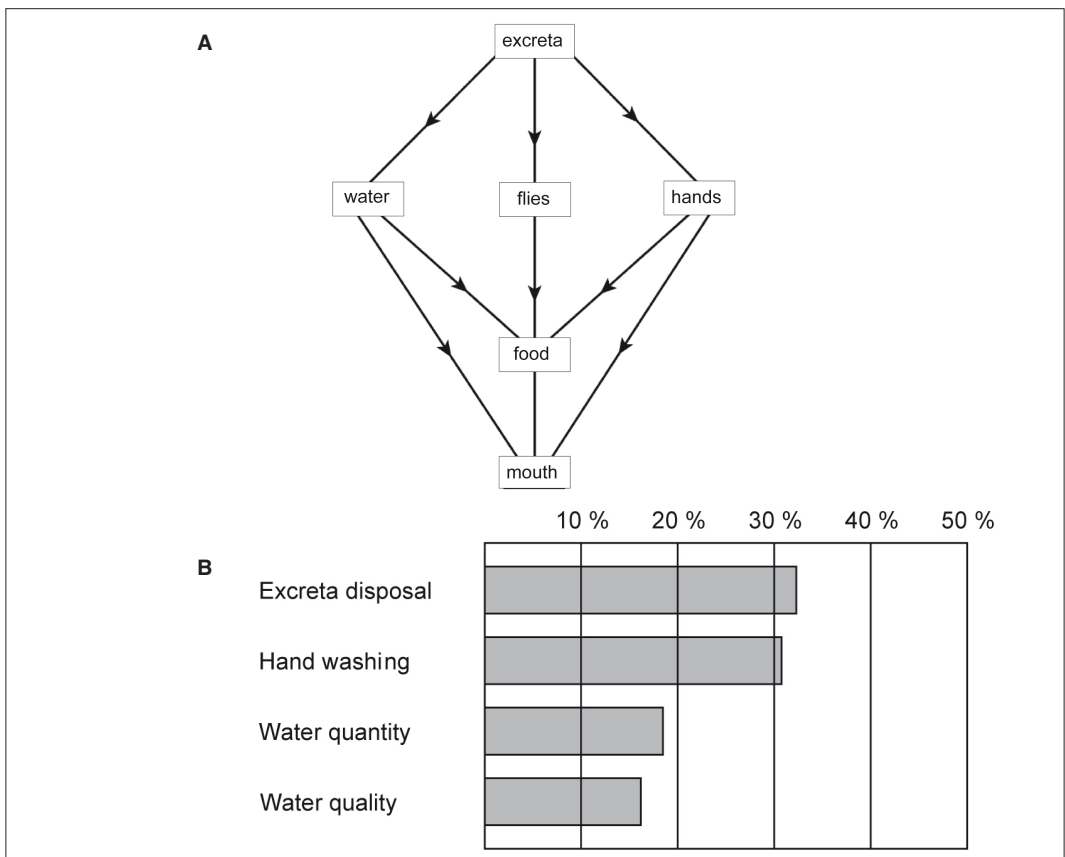
Assessments must be conducted with a multidisciplinary approach and an understanding that the causes of problems are complex and cross-cutting (health, food security, water etc.), so a global picture is necessary. The assessment team should comprise several specialists and the analyses should be conducted collaboratively.

Assessments also should follow a systematic approach, combining different levels of analysis: country, region, community and household levels. Special attention must be paid to vulnerable communities and groups.

When identifying water and sanitation needs, projects must focus on the relation between water, sanitation and hygiene, and the basic conditions for life, including:

- health: water and sanitation-related diseases, routes of transmission and causes of development;
- food availability and production: relation with house income;
- quality of life: how water and sanitation affects the life of the communities, including access in terms of time and effort spent.

These three factors were already developed in the Chapter 1, but special attention must be paid to the transmission routes for water and sanitation-related diseases. Assessments should identify the linkages between water, sanitation and illnesses, identifying common paths for disease transmission. Figure 2.2 shows the faecal-oral routes of disease transmission and the estimated impact of different activities in the reduction of diarrhoeal diseases.



**Figure 2.2: Faecal-oral routes of disease transmission (A) and estimated impact of different activities in the reduction of diarrhoeal diseases (B) (Esrey *et al.* 1991).**

## 2.2 Water and sanitation-related diseases

It is necessary to distinguish between the infectious water-related diseases (caused by living organisms and transmitted from one person to another, or from an animal) and those related to the chemical properties of water.

### *Health and water chemistry*

There are three main causes for diseases related to the chemical properties of water: the absence of necessary chemicals, the excess of harmful organics and the excess of harmful inorganics. The absence of essential substances in water is not generally a problem because there are alternative sources of these substances in food, and problems usually only occur when there is also a deficiency in the diet (e.g. iodine deficiency causing goitre, deficiencies of fluoride causing poor growth of bones and teeth in children). Diseases caused by harmful elements in water are discussed in Chapter 4.

Transmission of water and sanitation-related infections is mainly through the faecal-oral transmission routes, but also there are other routes also described below.

### *Water-related routes*

There are four types of water-related routes by which a disease may be transmitted from one person to another (adapted from Cairncross and Feachem (1983) *Environmental health engineering in the tropics*):

*Water-borne route*: transmission occurs when the pathogen is in water which is drunk by a person or animal which may then become infected. All the water-borne diseases can be also transmitted by any route which permits faecal material to pass into the mouth. For example, cholera may be spread by various faecal-oral routes (for instance via contaminated food).

*Water-washed route (or water-scarce)*: this concerns diseases for which transmission will be reduced following an increase in the volume of water used for hygienic purposes, irrespective of the quality of that water. There are three types:

- Infection of the intestinal tract, which includes faecal-oral route diseases (mostly diarrhoeal diseases, including cholera, dysentery) which can also be water-borne.
- Infection of the skin or eyes (bacterial skin sepsis, scabies, fungal infections of the skin, trachoma). These are not faecal-oral and not water-borne.
- Infections carried by lice, which may be reduced by improving personal hygiene and therefore reducing the probability of infestation of the body and clothes with these arthropods.

There are also other cases where availability of water is not a problem (floods, communities living in rivers or swampy areas), and risks of water-related diseases are high: again, hygiene is the key issue.

*Water-based route*: disease transmission is through pathogens which spend a part of their life cycle in a water snail or other aquatic animal. All these diseases are due to infection by parasitic worms (helminths), which depend on aquatic intermediate hosts to complete their life cycles. Guinea worm is the only one in this group which is normally transmitted in drinking water (it is not common, but schistosomiasis can be transmitted also in drinking treated water)

*Insect-vector route*: disease transmission is by insects which either breed in water or bite near water.

Table 2.I describes the main preventive strategies for the different types of water-related transmission routes. Further details of environmental classification for water-related infections are included in Annex 5A.

### *Excreta-related infections*

Some excreta-related infections are related to water but several are not, so the following environmental classification of the excreta-related diseases is used:

1) *Faecal-oral diseases (non-bacterial)*: caused by viruses, protozoa and helminths present in human faeces; can be transmitted from person to person and through domestic contamination.

**Table 2.J: Types of water-related transmission routes for infections (adapted from Cairncross & Feachem 1983).**

Transmission route	Preventive strategies
Water-borne	Improve quality of drinking water Prevent casual use of unprotected sources
Water-washed (or water-scarce)	Increase water quantity used Improve accessibility and reliability of domestic water supply Improve hygiene
Water-based	Reduce need for contact with infected water* Reduce contamination of surface waters**
Water-related insect vector	Improve surface-water management Destroy breeding sites of insects Reduce need to visit breeding sites Use mosquito netting

\* Applies to schistosomiasis only.

\*\* The preventive strategies appropriate to the water-based worms depends on the precise life-cycle of each and this is the only general prescription that can be given.

2) *Faecal-oral diseases (bacterial)*: caused by bacteria; can be transmitted from person to person, or via food, crops or water sources contaminated with faecal material. Some of them can be transmitted in animal excreta.

3) *Soil-transmitted helminths*: this category contains several species of parasite worm whose eggs are passed in faeces. They require a period of development in moist soil, then they can reach humans by being ingested, for instance on vegetables, or by penetrating the soles of the feet.

4) *Beef and pork tapeworms*: these tapeworms of the genus *Taenia* require a period in the body of an animal before reinfesting man when the animal's meat is eaten without sufficient cooking. Any system which prevents untreated excreta being eaten by pigs and cattle will control the transmission of these parasites (it is also important to take care with treated sewage or sludge that is applied to grazing lands).

5) *Water-based helminths*: helminths present in human or animal excreta pass a stage of their life cycle in the body of an aquatic host (usually a snail). Then they can be transmitted to man through the skin or when aquatic food is not well cooked. It is important to avoid untreated excreta from reaching water.

6) *Excreta-related insect vectors*: there are two types: first, the *Culex pipiens* group of mosquitoes breed in polluted water (septic tanks and flooded pit latrines) and transmit filariasis; second, flies and cockroaches breed where faeces are exposed, and carry pathogens on their bodies and in their intestinal tracts.

Annex 5B includes the environmental classification of excreta-related infections.

An assessment should identify the presence of these water and sanitation-related diseases (mortality and morbidity rates, age distribution) and analyse the causes. Solutions will focus on decreasing disease transmission, hygiene promotion, sanitation and water supply.

It is also important to analyse all the factors that affect the spread of diseases and cause outbreaks, such as poor environmental conditions, high population density etc.

For a more complete presentation of water and excreta-related diseases, see Annex 5C.

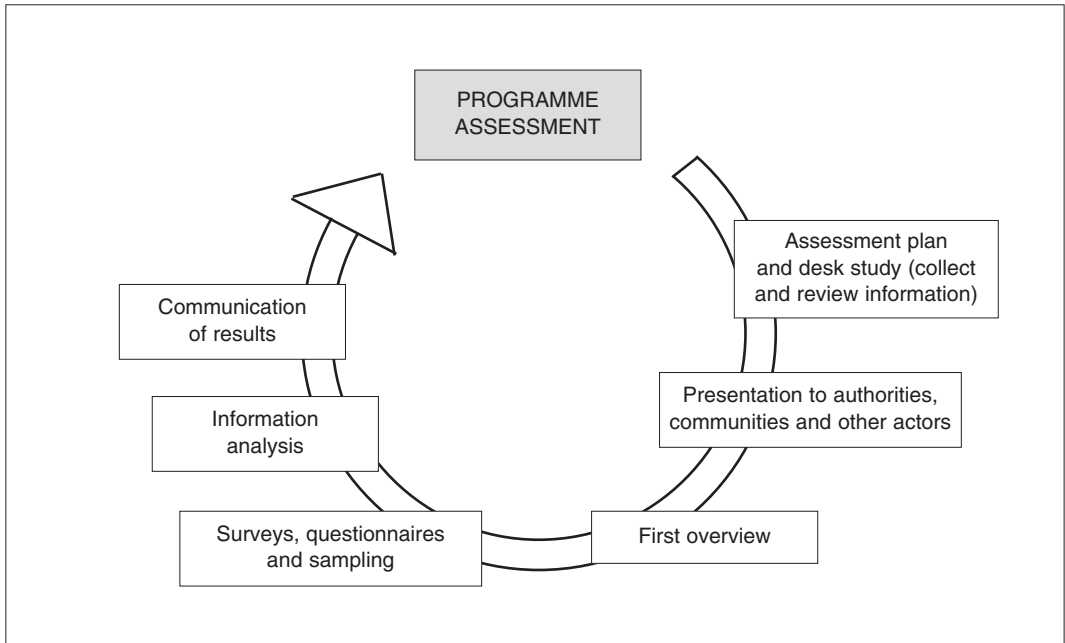
## 2.3 Assessment components

Assessment should be an iterative process with differentiated stages (see Table 2.II and Figure 2.3). It starts with the preparation phase, where the different activities and resources necessary to run it are planned. Once the plan is made and the resources are available, it is important for the assessment team to introduce itself to the involved communities and stakeholders, explaining the aim of the assessment. Following this, a first overview serves to set the priorities and the various information-gathering activities are carried out. Analysis of the information starts at the same time as the collection process and continues until all the information is treated. Once the analysis is done and the results of the assessment are concluded, it is necessary to communicate and transmit them.

Box 2.2 presents some general advice to take into account during assessments.

**Table 2.II: Components of an assessment.**

1) <i>Preparation</i>	Collect and review existing information Terms of reference: – where is the assessment being carried out? – how long will the assessment be? – what resources (human and financial) are required? – what tools and materials are required? (checklists, computer, GPS) – what are the security constraints? Coordination with other stakeholders
2) <i>Introduction to communities, authorities and other actors</i>	Introduction of the organisation and the assessment team Explanation of the assessment, objectives and coordination requirements Collection and sharing of information
3) <i>First overview</i>	Global picture of the situation: main needs, actors involved, local capacities Identification of key informants Definition of priority communities and vulnerable groups More detailed planning of the assessment activities Basic mapping and general checklists to get information
4) <i>Surveys, questionnaires and sampling to gather qualitative and quantitative information</i> <i>Tools used vary depending on time and resources available</i>	Vulnerability surveys Field surveys Sanitary surveys Discussion groups Personal interviews Maps Sampling (water analysis, etc.)
5) <i>Analysis of information</i>	Organisation of information Prioritisation of information Conclusions and recommendations Reporting
6) <i>Communication of the results</i>	Communication and discussion with involved communities and other stakeholders



**Figure 2.3: Stages of an assessment.**

#### Box 2.2

##### General advice on assessments.

Several elements are fundamental to developing a useful assessment and they should be considered from the earliest preparation stage:

*Timing* should be allotted to each stage (strategy, assessment, etc.) as appropriate.

*Respect for social and traditional protocols* should be foremost in interactions with communities, the authorities and local leaders in terms of the following:

- following the traditional manners;
- dressing respectfully;
- choosing an appropriate place to make introductions such that others feel comfortable;
- structuring the interview and following an order, but leaving the interviewee to express his or her ideas and comments freely;
- building trust: not starting with sensitive issues, but building the trust of those interviewed first;
- limiting transcription: writing down everything someone is saying can be intimidating.

*Discussions* should be held with the team each day in order to brainstorm, plan activities, improve methodologies, etc.

*Analysis of information* must be done throughout all the steps – not only the final step. This continuous analysis allows the assessment process to be modified and adapted.

*Communication of results* to communities and other actors is important both to provide information and also to verify and complete information. Before leaving the community it is advisable to report the main conclusions of the assessment.

## 2.4 Resources and means to do an assessment

The size and expertise of the assessment team will depend on the objectives and magnitude of the assessment. However, different specialists should be involved, in order to have an integrated approach. Team members should include technical experts as well as those who are close to the target groups (translators are also necessary if there are members who do not speak the language fluently). Involvement of both men and women is particularly important, as a single-sex team may not be able to gain a complete picture of the community.

Transportation, food and financial allocations must be planned in advance. The equipment required depends on the type of assessment. However, some suggestions include:

- pens and paper for surveys and questionnaires (notebooks are useful);
- pre-prepared tools for working with groups: board, panels, diagrams etc.;
- brochures and papers presenting the organisation;
- GPS, altimeter and maps;
- technical water equipment: water-analysis kits, depth meter, flow meter, altimeter, pumping-test kits, geophysical equipment;
- computers and software: GIS (Geographical Information System) software (e.g. MapInfo, ArcView, ArcInfo), SPSS (Statistical Package for the Social Sciences), software useful for social analysis (including KAP surveys etc.), EpiInfo (Statistical software for epidemiological and health analysis) etc.

## 2.5 Information gathering

It is recommended to follow an iterative process between the collection and analysis of data. Quantitative information should be complemented with qualitative information. Statistics and figures must be analysed and explained so that they are understandable to the community.

Information should be collected from communities in a participatory manner. The approach can vary both among groups and within groups. Children, the elderly, marginalized people, and men and women may each require different approaches. Gender must be considered as a primary issue in assessments.

### 2.5.1 INFORMATION-COLLECTING TECHNIQUES

The choice of techniques and tools to collect information depends on the time and resources available. There are five main techniques:

- *Review of existing documentation.* This can be done during all the assessment process, and the information collected must be analysed and well referenced.
- *Conducting field and sanitary surveys.* Both technical measurements (water analysis, GPS location, water-table depth) and direct qualitative observations (e.g. queuing at water points) are important.
- *Personal interviews* (if it is difficult to cover all the target population then a representative sample of people can be selected from the community).
- *Interviews with key informants.* Select key people who can provide information about general or specific issues: teachers, local authorities, health personnel, water point managers, women's organisation leaders etc.
- *Focus-group discussions.* Between 5 and 10 is a good number of people for a group. Larger groups will require more developed interviewing and assessment skills. Participatory Rural Appraisal techniques ((PRA), see Chapter 15) solicit group participation and are useful for obtaining information. Homogeneous groups (by age, gender or social status) can be appropriate as people may be more open to express ideas without the pressures of other groups present.

Interviews require good skills and practice in order to obtain useful information. It is important to be well-understood and it is best to speak in the local language or have a good translator who is familiar with the community and its members (See Box 2.3).

### Box 2.3

#### Interviewing techniques.

The delivery of questions is important in collecting useful information. Essential rules include:

##### *Build trust*

The interviewee must be comfortable with the interviewer. It is often a good idea if it is a member of the community who conducts interviews, after receiving training. It is also recommended that women are included on the assessment team, as in many cultures, women interviewees will be more forthcoming with other women.

##### *Follow a sequence*

Go from the general issues to the specific ones. Guiding words for questions are: Who? What? Why? When? Where? How? The interview is best conducted informally, more as a discussion.

##### *Follow up*

If a general question elicits an answer that implies more than one concept, follow up with more specific questions on each concept.

##### *Avoid leading questions*

Beware of assumptions. If the interviewer provides the answer in the question, other possibilities may be missed. Examples of leading/non-leading questions:

- Leading: “Do you fetch water from the well?” Non-leading: “Where do you fetch water from?”
- The leading question “Do you clean clothes in the well or the river?” should be formulated in several sentences: first asking “For which purposes do you need water?” and once a list of water uses is prepared, asking for each use “Where do you take the water from for this?”

##### *Avoid ambiguous questions and unknown terms and concepts*

- The question “Is it difficult to find water?” can be understood as difficulty in fetching the water (steep slopes or time consuming) or difficulty in actually locating water at all.
- Quantities and measures (distance, volume, weight, time, etc.) that are familiar to the interviewer may not be familiar to the interviewee. “How many litres do you consume per day?” may be inappropriate if the interviewee is not clear on the quantity associated with a litre. Interviewees may attempt to give answers in measurements they are not familiar with in an effort to answer. It is best to keep questions simple and try to solicit responses in measures common in the community. For example, if you see jerry cans at a person’s house, ask how many jerry cans they use. For distance, use familiar points of interest, for example “The water point is twice the distance to the school”. Rather than asking how many hours it takes to collect water, find a way to ask in terms of local schedules, maybe using meal times, as in “I leave after breakfast and come back before lunch”.

*Cross-check information among a variety of sources to compare and validate it.*

Most information is subjective and often represents personal points of view or personal interest. One person’s information may not fit the reality of the entire community. The interviewer must observe the attitude of the interviewees and gather information from many sources.

#### 2.5.1.1 Participatory techniques

Participatory techniques are an approach (and family of methodologies) for shared learning with local communities in order to plan appropriate interventions together.

Bases of the participatory techniques:

- *Triangulation*. Analyse the problem from different perspectives:
  - using a variety of techniques and sources (observation, bibliography, survey);
  - meeting with various target groups (men, women, youth, elders, marginalized people etc.);
  - using more than one assessment team.

– *Understand possible information gaps.* Selecting only specific groups may not represent the reality of the entire community. Common errors in information collection are due to:

- easy access: places with easy access may not be the most representative;
- seasonal variations: problems and life may be different in different seasons. Be sure to account for this in information collection;
- personal points of view: this will vary among interviewees. Be sure to interview several people representing different views, not only community leaders;
- access to women: it can be difficult to speak with women. However, speaking directly with women is essential. It may be necessary to do this when a man is not present to gain more accurate information;
- expectations of the population: for example, if a community knows that the organisation is working on water, water may appear to be the major priority as they are trying to access all the assistance they can. However, a water-supply intervention may not be the most appropriate;
- courtesy: people may try to make you comfortable with their answers, at the expense of the true picture.

– *Knowing when to stop collecting information.* It is not possible to know everything. Given time and resources, at some point the programme manager will need to decide that enough information has been collected.

Good examples are the PRA techniques (Participatory Rural Appraisal).

PRA originated in RRA (Rural Rapid Appraisal, using on questionnaire-based surveys, popular until the 1970s). PRA was developed to provide a less extractive and more participatory approach that gave communities more ownership of the process and results.

PRA principles are described in Box 2.4 and main participatory techniques used by PRA are described in table 2.III.

PRA techniques are explained further in Chapter 15.

#### Box 2.4

PRA: key principles.

Participation: local people serve as partners in data collection and analysis.

Flexibility: there is no standard methodology. It depends on purpose, resources, skills and time.

Teamwork: outsiders and insiders, men and women, mix of disciplines are included.

Cost and time efficient, but ample opportunity for analysis and planning.

Comprehensiveness: for validity and reliability, partly-stratified sampling techniques and cross-checking should be used.

**Table 2.III: PRA: key techniques.**

---

Interviews/discussions: individual, household, focus groups, community meetings

History line

Mapping: community maps, personal maps, institutional maps

Ranking: problem ranking, preference ranking, wealth ranking

Problem trees

Trend analysis: historical diagramming, seasonal calendar, daily activity charts

Gender profiles

---



### 2.5.1.2 KAP surveys

Knowledge, Attitudes and Practices (KAP) surveys are focused on hygiene habits and behaviour and, together with participatory techniques, serve to identify and understand the approaches of the communities to these issues. The surveys are conducted to better understand why people are not practicing good hygiene. It may be because they do not have the knowledge necessary, there is something in the local culture or attitude that gets in the way or there is a breakdown in practice even though people hold the appropriate knowledge and attitudes. KAP surveys are also useful for measuring the impact of hygiene promotion projects and identifying where changes took place. KAP surveys are explained in more detail in Chapter 15.

## 2.5.2 Types of information

An assessment of water and sanitation first requires a general overview of the situation (what are the main general needs and what are the main problems that affect the community) as well as a good understanding of the relations between the different domains (health, food security, education etc.). After this is obtained, deeper analysis of water and sanitation issues should be conducted.

Information should be gathered at macro and micro levels, from reports, maps, databases etc. Special attention must be paid to the definition of indicators that describe the more basic needs.

### 2.5.2.1 General information

The main general information to be collected in the project identification phase is listed below:

- Geographic characteristics: principal locations, borders, climate, vegetation (accompanied by maps if possible). Natural disaster impact.
- Population: numbers and demographics (ages, sex, ethnic group, religion, nomadic populations, urban/rural migration, vulnerable groups).
- Politics: structure of the communities, local and traditional authorities, conflict between groups.
- Culture and religion.
- Resources: production, commercialisation, wealth indicators.
- Food availability:
  - markets: type of products, prices, access;
  - local production:
    - . agriculture: seasonal calendars;
    - . livestock;
    - . other resources;
  - food aid received:
    - . quantity per person per day;
    - . type of distribution, time and agency responsible;
  - access to food:
    - . family reserves;
    - . income-generation activities;
    - . coping mechanisms (changes in consumption patterns, capital losses, mutual support mechanisms etc.).
- Education: levels of schooling and literacy, general conditions in the schools.
- Health:
  - common diseases, prevalence and incidence of water and sanitation-related diseases;
  - risks of epidemics: critical places and periods;
  - mortality and morbidity rates: main causes of death;

- general conditions of sanitary structures;
- access to health services and drugs.
- Nutritional status (anthropometric surveys, weight-for-height).
- Local capacity: market availability of supplies, private contractor capacity, leadership capacity of the local authorities etc.
- Security situation.
- Communications: access, routes, transport, phone, radio, e-mail.
- General coverage of water and sanitation.
- Risk management.
- Preparedness capacities.
- Actors involved and areas of work: donors, international organisations and agencies, local organisations, local structures, businesses, private individuals, schools, universities or research entities.

Key indicators serve to better measure the situation and its evolution. Use and calculation of general key indicators are included in Annex 2A.

#### 2.5.2.2 Specific information on water and sanitation

Specific information related to water is developed as follows.

##### 1) Information related to the most basic needs

- Water-related diseases.
- Quantity of water related to different uses and requirements (human consumption, agriculture, livestock, environmental needs, other uses).
- Access to water: distance from household to water point, and collection time. Queuing time, and who collects water. Number of people using the water point and pressure on the water point.
- Water-quality analysis at various stages (water point, transport, storage, distribution, consumption). Identification of source of contamination.
- Are there any minimum standards as references?

##### 2) Information relating to existing policies

- National, regional and local laws/traditions concerning water and sanitation.
- Existing guidelines and standardised solutions.

##### 3) Water resources (Table 2.IVA)

- Exploited and potential resources.
- Characteristics of the resources: water quality, capacity of supply, definition of the aquifers.
- Prospecting information: geological studies, maps, aerial / satellite photos, water-resource studies.
- Seasonal variations of quantity.
- Water quality.

##### 4) Water Systems

- Number and characteristics of existing water points (Table 2.IVB).
  - Type.
  - Condition and cleanliness.
  - Yield.
  - Quality of water.
  - Date of construction, constructor.
  - Ownership.
- Water source.
- Flow system: type (gravity, pump etc.) and characteristics (Table 2.IVC).

**Table 2.IV: Types of water resources, water points and extraction systems.**

---

**A. WATER RESOURCES**

<i>Rainwater</i>	Annual rainfall distribution Calculation of water collected in the possible catchment area
<i>Surface water</i>	Exploitable water volume Access to the resource: distance from the settlement, topography Sustainability of the resource: rate of rise and fall Water quality
<i>Groundwater</i>	Location of the aquifer Exploitation capacity Geophysical characteristics Recharge rate Water quality (arsenic, etc.)

**B. WATER POINTS**

<i>Rainwater</i>	Volume of water available per day: depends on rainfall regime, catchment area, storage and consumption systems Percentage of the year with water availability Water quality
<i>Boreholes</i>	Depth, equipment, recharge rate, seasonal variation, yield, diameter, casing type, location of screen Water quality Pumping system Date of commissioning Ownership Constructor
<i>Wells</i>	Type: traditional, protected, type of casing Characteristics: depth, seasonal variation, recharge rate, yield, diameter, location of the catchment. Lift system: pumps, pulleys, etc. Date of commissioning Ownership Water quality
<i>Springs</i>	Flow, seasonal variations Protection of the spring (catchment) Distance from village Distribution system Water quality

**C. WATER-ABSTRACTION SYSTEMS**

<i>Manual</i>	Abstraction capacity Cleanliness of equipment (rope and container) Water quality (especially bacteriological) and identification of source of contamination
<i>Handpumps</i>	Type Characteristics Yield Length of pipes and depth of the cylinder Water quality (bacteriological, iron, etc.)
<i>Motorised pumps</i>	Power and electrical characteristics Pump curve, yield and total generated head (TGH) Depth of pump, diameter, length of the pipes Water quality (bacteriological and iron) Working hours per day
<i>Solar systems</i>	Power and electrical characteristics Pump curve, yield and TGH Operating hours and capacity of supply per working day depending on the season Maintenance schedule Water quality
<i>Wind pumps</i>	Pumping characteristics Wind characteristics Operating hours and capacity of supply per working day depending on the season Water quality Management Ownership

---

- Treatment system.
  - Need for treatment.
  - Type of treatment.
  - Treatment monitoring (water analysis).
  - Household treatment (boiling, filtration with clothes etc.).
  - Availability and type of disinfectant and or filtration.
- Water-supply system.
  - Distribution at the water point.
  - Water trucking: volume of storage, quality of water, final supply modality, supply management, access problems.
  - Water-distribution networks.
    - . Type of network (gravity or pumped).
    - . Quantity and quality of water produced.
    - . Reservoirs: type and volume.
    - . Pipeline characteristics (length, diameters, materials, fittings, control devices, pressures).
- Water distribution: (number and type of taps, public places). Who is going to take the water?

### 5) Containers and household handling of water, type, volume, cleanliness, storage

#### 6) Water management

- Hours of use.
- Management.
- Ownership.
- Are user fees being paid?
- Does price limit access?
- Capacities for maintenance and new construction (availability of skilled people, equipment, materials and spare parts).
- Restricted access for animals.

Sanitation and hygiene promotion information require a good knowledge of beliefs and social habits (see Chapters 13 and 15). A summary of the main information required is listed below:

- Sanitation facilities.
  - Excreta disposal, characteristics and conditions.
    - . Latrines
      - Type and condition.
      - Coverage of latrines (people per latrine, % of people using a latrine).
      - Public latrines / family latrines.
      - Emptiness and life expectancy.
    - . Sewerage system characteristics.
    - . Existence of grey water and black water treatment.
  - Hygiene facilities (rivers, showers, laundry areas etc.).
    - . Coverage.
    - . Type and condition.
    - . Drainage.
  - Refuse management.
  - Existence of flooding problems due to poor drainage.
- Hygiene habits.
  - Knowledge, use and habits.
  - Availability of soap and hygiene products.

- Main vectors of diseases. Identification of the most exposed areas.
  - Environmental conditions.
    - Characteristics related to water resources: sources of contamination, overexploitation.
    - Deforestation, erosion problems.
    - Stagnant water, drainages systems.
- Calculation of key indicators for water, sanitation and hygiene are included in Annex 2B.

## 2.6 Assessment in emergencies

Assessment tools and methodologies must be adapted for emergency responses. Time is an important constraint and will affect the way assessments are carried out.

### 2.6.1 RAPID APPRAISAL

Rapid appraisal is the first activity to be undertaken at the onset of a disaster. It should take place immediately after the disaster occurs and be completed as soon as possible – usually within a few days.

The purpose is to gather sufficient information to decide whether the agency should respond to the emergency or not. It is not intended to be an in-depth assessment of the situation and often will not even involve personnel leaving the office.

The information can be gathered from:

- Local/national media such as TV, radio, newspapers, specialised relief agencies (IRIN etc.).
- Networking with other agencies, NGOs, government departments, UN agencies etc.
- Individual contacts.

The kind of information required includes:

- Whether or not the disaster represents a widespread threat to life, and if so, in what way.
- How and when the disaster occurred.
- The extent of the destruction resulting from the disaster.
- The area affected and the impact.
- The people affected and how they are affected.
- Capacity of local structures/resources to deal with the disaster.
- The extent to which other agencies (local, national or international) are able and ready to intervene and whether or not any possible response is adequate.
- The security situation.

If the initial decision is:

- *No action needed* – the disaster should be monitored and re-visited if and when circumstances change.
- *Action is needed* – a concept paper should be written detailing the assessment that needs to be undertaken, including terms of reference. In severe disasters, this will occur very quickly.

### 2.6.2 RAPID ASSESSMENT

A rapid assessment needs to provide timely, relevant and adequate information to enable effective decision making. The short time available and the need to provide a quick response are important factors that determine the assessment process and techniques. The assessment process is normally more directive than participative: the various information sources should be consulted but this is not the time to develop group dynamics well with the affected communities.

Box 2.5 presents the three main components of a rapid assessment.

Checklists are a very useful tool for emergencies, guiding the assessor in compiling the most important information to assess the situation. One example is the water supply and sanitation assessment checklist provided by Sphere (Annex 3).

#### Box 2.5

##### The 3Ds of rapid assessments.

*Desk study* (other people's information and views).

*Direct* (personal observations and measurements).

*Discussion* (semi-structured interviews or small meetings with key groups and individuals).

## 2.7 Sanitary surveys

A sanitary survey is a quick assessment focused on the evaluation of the environmental factors and human practices which could signify a danger to health. Most systems use checklists where parameters are scored 0 or 1, to produce a "total risk score" from the sum of specific risk points, which can be used to compare different situations.

Sanitary inspections are useful to identify possible sources of contamination of existing water sources in order to establish the remedial actions required and to assign priorities. They also provide an important baseline to monitor the situation and the impact of projects.

Sanitary surveys and inspections focused on water quality are further explained in Chapter 4. Examples of sanitary inspection forms and an example of risk analysis are included in Annex 7B.

## 3 Project design

The *identification phase* must provide a clear picture about needs, existing capacities and specific characteristics to understand and prioritise a situation. With this picture, a decision about whether or not to proceed in the preparation of a project can be made.

The *project design phase* goes further in the definition of the project, studying different possible solutions and how they can be developed. Any proposed actions should be analysed in terms of relevance, feasibility and sustainability.

During both phases, the participation of beneficiaries and other stakeholders is fundamental to guarantee the success of the project.

Project design can be undertaken in a variety of ways. However, the most commonly used method is the *Logical Framework Approach* (LFA), which it is a planning tool for development projects and useful for management. It can be split into two phases:

- Analysis Phase: where the existing situation is analysed with the aim of developing a 'future desired situation'.
- Planning Phase: where the project's operational details are developed.

### 3.1 Analysis phase

A properly planned project addressing the real needs of the beneficiaries cannot be achieved without an analysis of the existing situation. A situation can be perceived in different ways by different groups or stakeholders, and all of them must be involved in the analysis phase.

The analysis phase can be included in the project cycle within the identification phase. Although the participatory tools used can be the same, the analysis phase is oriented towards the development of a project, whereas identification is a wider concept and not necessarily related to the design of a project.

The analysis phase has three stages:

- Problem analysis.
- Analysis of objectives.
- Strategy analysis.

### 3.1.1 PROBLEM ANALYSIS

To design a project well, it is necessary to identify and analyse the negative impacts of a given situation, establishing cause-effect relations. Involving all the project stakeholders, in a participatory process, is essential.

Problem analysis can be done in three steps. Often this overlaps with the identification phase; however, the problems should be reviewed in the context of designing a project rather than just understanding the context. The three steps are:

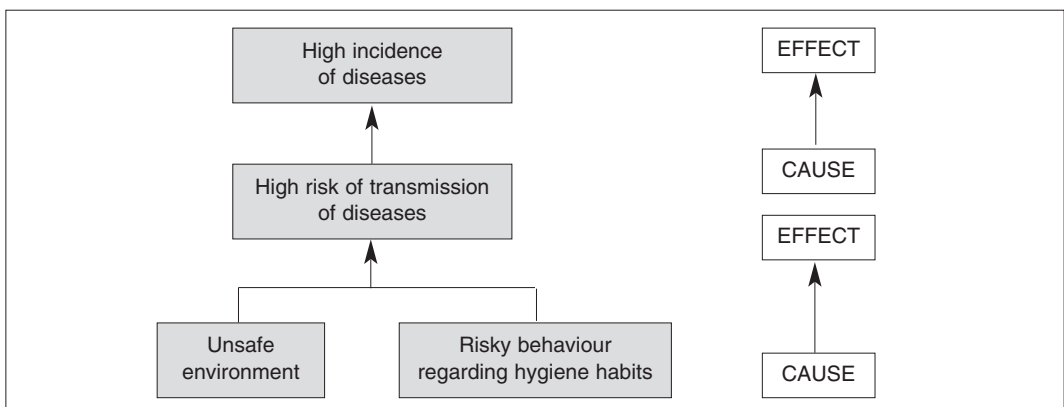
- Identification of the stakeholders.
- Identification and prioritisation of the major problems faced by the communities and other stakeholders.
- Development of a problem tree to establish causes and effects.

The analyses done with the various stakeholders should be combined with others such as technical, economic and social studies.

#### *Development of a problem tree*

Preliminary discussions with stakeholders give the assessor an understanding of the problems faced by people. After collecting this information, a workshop can be conducted to explore the root causes of problems and a ‘problem tree’ can be created to enhance understanding of the problems at hand. Workshops should be led by facilitators trained in participatory techniques and project design. Steps in leading a discussion include:

- Listing of problems: identification of problems can be done with the communities and other main stakeholders through brainstorming. Each problem can be written on paper and stuck on a board.
- Grouping: problems can be grouped by theme. Those repeated or not relevant can be eliminated in consensus with the group.
- Prioritise: the next step is to list the problems in order of importance, choosing the most relevant or representative from each group.
- Exploring roots: begin to explore the cause-effect relations in order to prepare the tree. Causes should be logical, direct and hierarchical; creating different levels and branches. One problem should be at the top of each tree, as in the examples in this chapter, or at its centre. During the construction of the tree, problems can be modified and other problems can be identified and added. Once complete, the problem tree represents a comprehensive picture of the existing situation and enables project designers to understand where interventions can and should be targeted. Figure 2.4 shows a simple example of a problem tree.

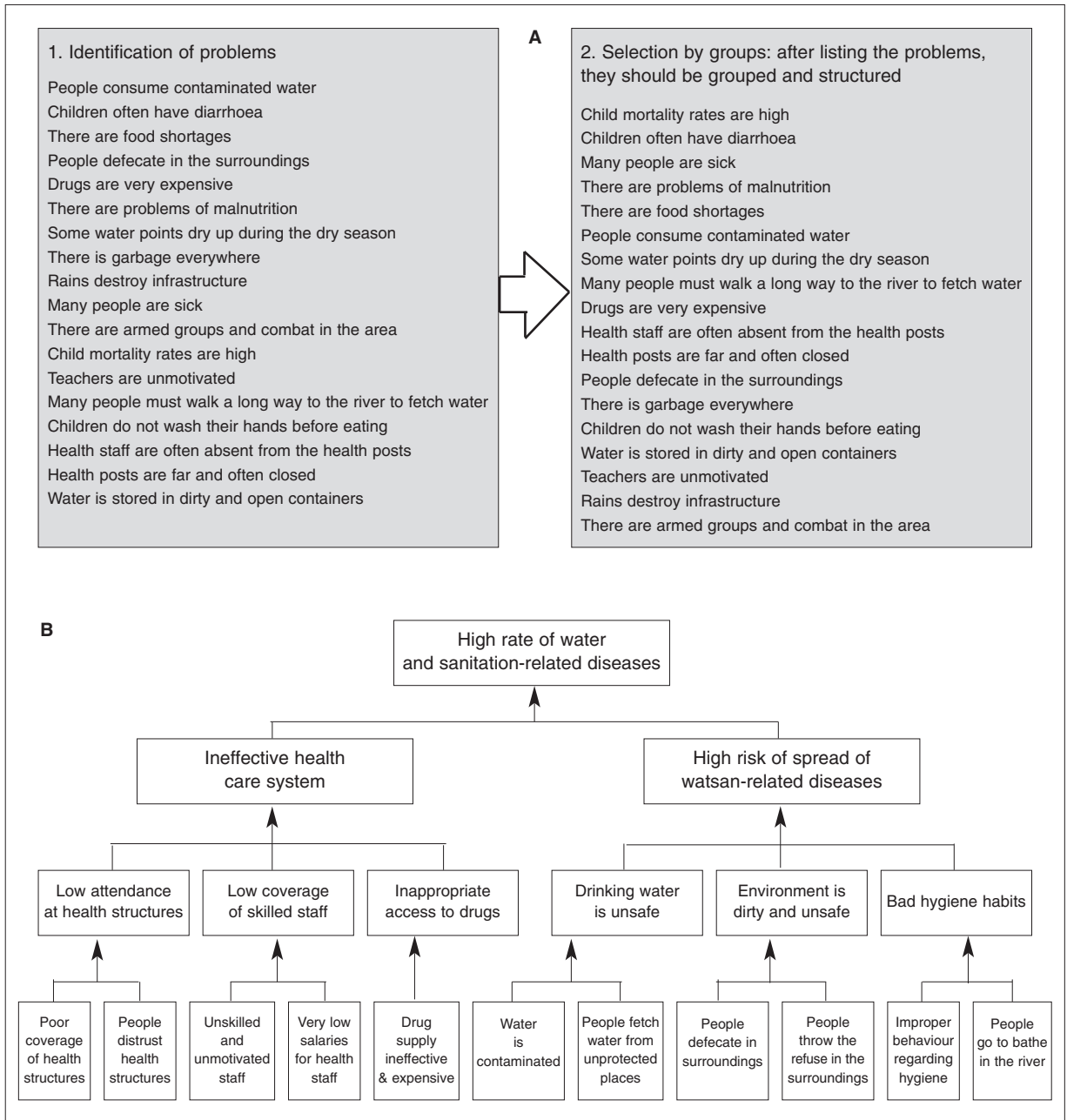


**Figure 2.4:** Simple example of a problem tree.

– Problems must be well specified and statements must be in enough detail to understand the causes of the problem.

*Note.* – Problems should be stated not as the absence of a solution (e.g. water is not treated) but as an existing negative state (e.g. water is contaminated).

Figure 2.5 illustrates the elaboration of a problem tree.



**Figure 2.5: Example of elaboration of a problem tree.**

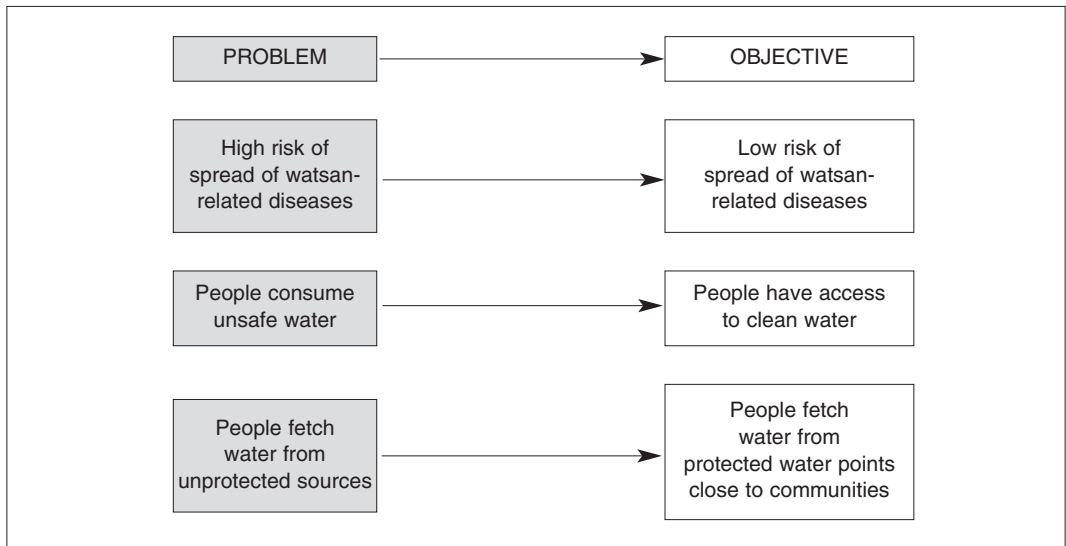
**A:** listing of problems and selection by groups. **B:** problem tree.



During the development of the problem tree, problems can be reformulated, some can be combined in order to express one concept and others can be rejected after consensus among the group and explaining why. Figure 2.5B presents the development of the problem tree from the problems identified above.

### 3.1.2 ANALYSIS OF OBJECTIVES

The objective tree presents a picture of the desired future situation and often transforms problems into objectives, as shown in Figure 2.6.



**Figure 2.6: Transforming problems into objectives.**

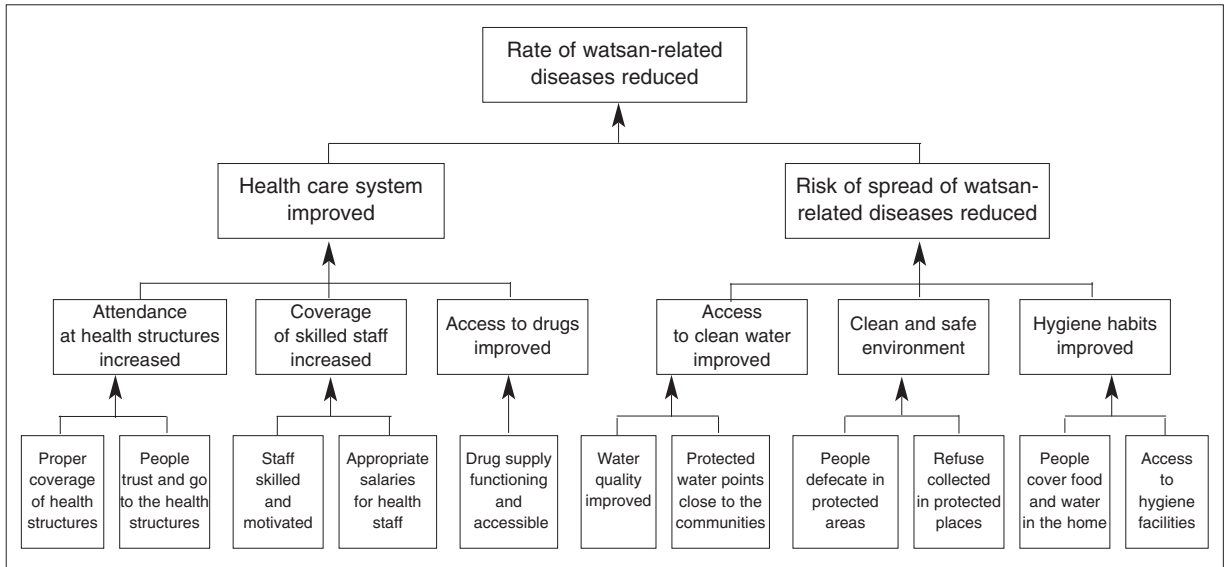
Objectives should be positive statements of the desired situation, rather than the specific actions required to solve the problem. An example with correct and incorrect transformations of problems into objectives is shown in Table 2.V.

The objective tree can be conceptualised as the positive mirror image of the problem tree, and the ‘cause-and-effect’ relations become ‘means-to-ends’ relations. The objective tree can be modified and relations between objectives should be reviewed and reorganised as necessary (keeping the logic and the hierarchy). Some objectives may be unrealistic, so alternatives to tackle the problem need to be found or the attempt has to be abandoned.

Figure 2.7 shows the development of the objective tree from the problem tree developed in Figure 2.5.

**Table 2.V: Transformation of problems into objectives.**

Problem	Water-supply system in bad condition
Objective	<i>Incorrect:</i> Repair of the water-supply system <i>Correct:</i> Water-supply system in good condition



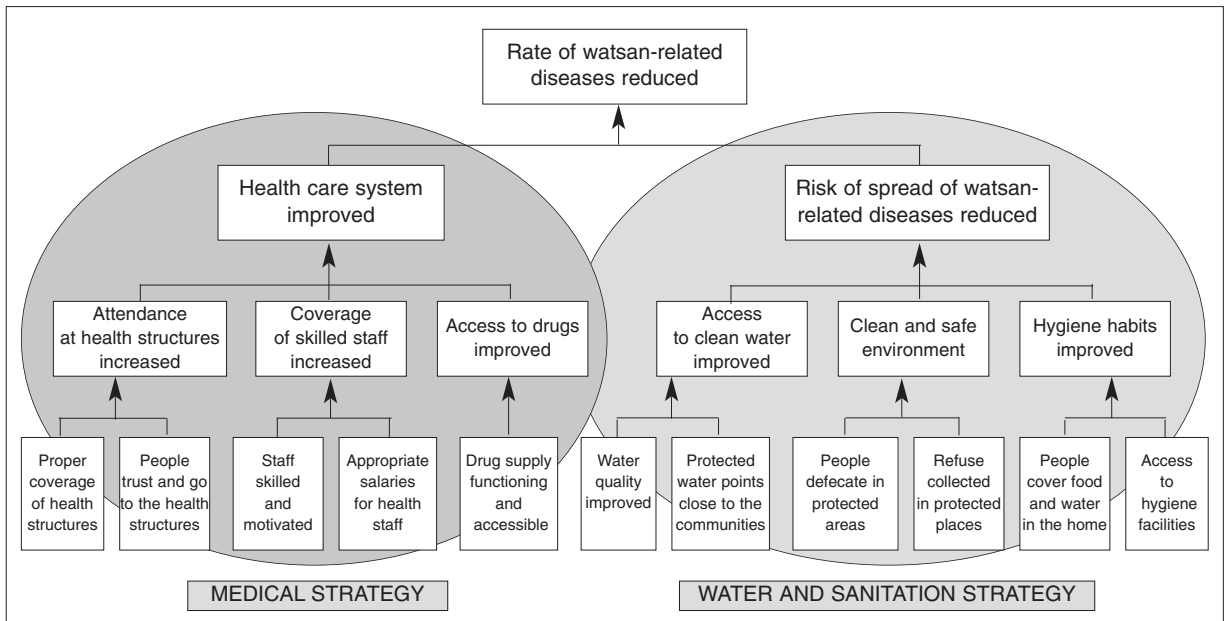
**Figure 2.7: Development of an objective tree.**

### 3.1.3 STRATEGY ANALYSIS

The last stage of the analysis phase involves the identification of the different possible strategies. This is done by making groups of objectives closely related and with a similar purpose (as ‘branches’ of the tree)

A strategy can be developed after one or more focal objectives have been chosen. This analysis includes the feasibility of achieving the objectives (amount of work entailed, capacities to do it, period of time to be covered, budget available, interest and participation of the community concerned etc.) and the relevance and sustainability of the strategy. Based on criteria set for each situation, some

**Figure 2.8: Strategy analysis.**



objectives will be selected and others excluded. Figure 2.8 presents the strategy analysis based on the objectives developed in Figure 2.7.

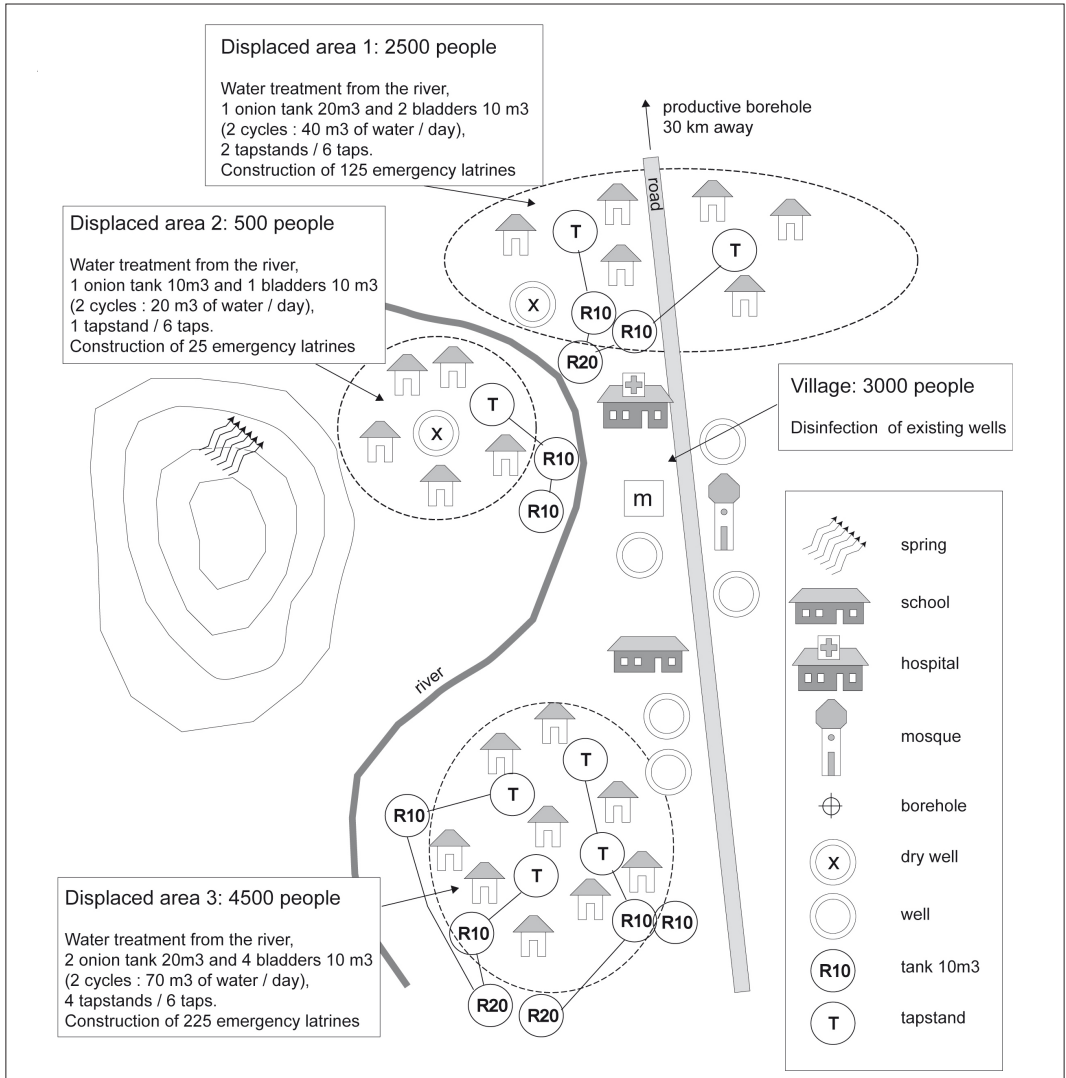
Strategies are further developed to create a basis for project preparation. A deeper development of the intervention should be conducted and further technical analyses must complement the basic strategy in designing the project. It is important also establish priorities and different phases of the intervention.

Coverage maps are a useful tool to plan the intervention and the following planning phase (see Figures 2.9A and 2.9B).

*Example of strategy based on several phases*

*Phase 1:* first response to achieve 15 litres of water per person per day and 20 people per latrine.

*Phase 2:* permanent water points and household latrines.



**Figure 2.9: Water and sanitation coverage map. A: phase 1, response to a population displacement.**

## 3.2 Planning phase

The planning phase is when the necessary operational project details are developed.

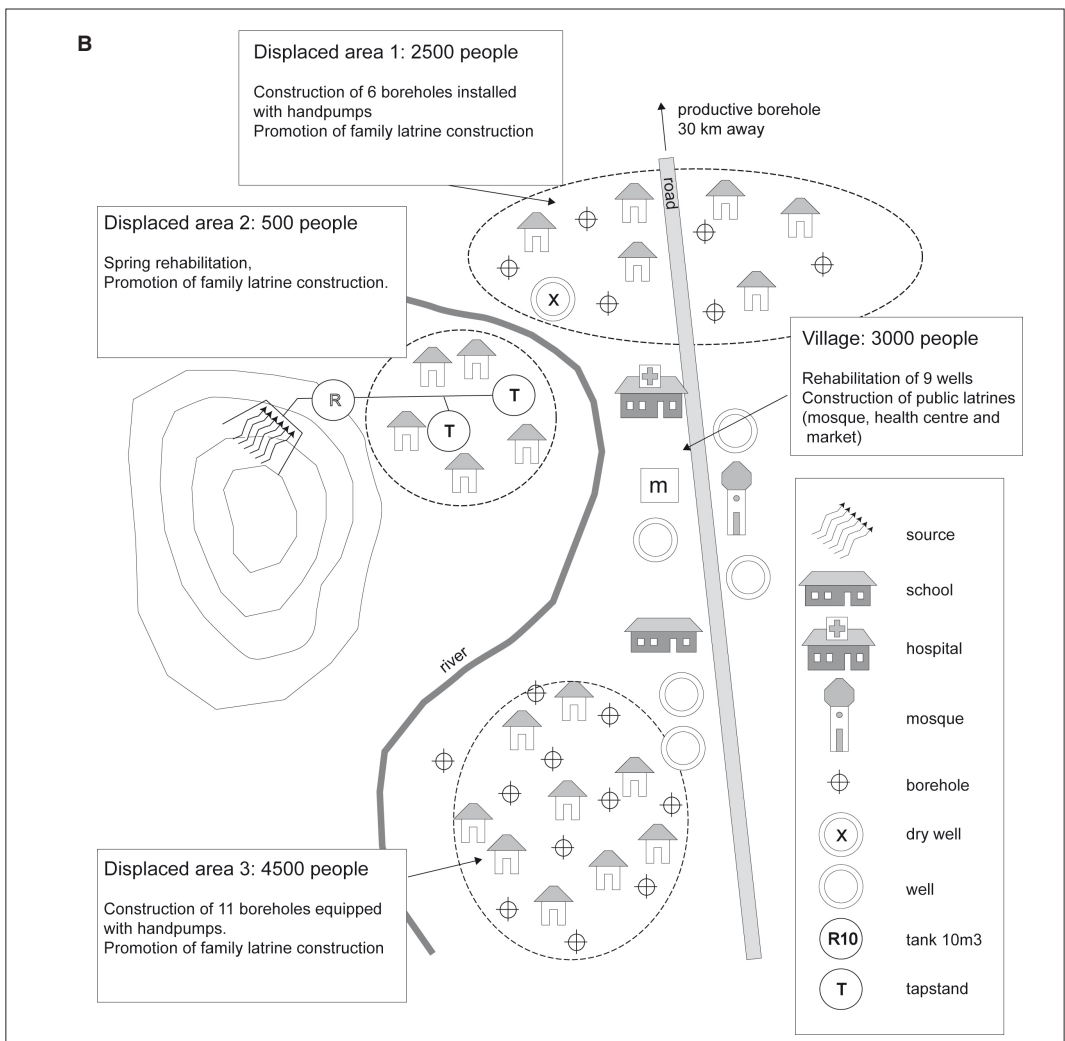
Where the logical framework approach (LFA) is used, the *Logical Framework Matrix* is the main output of this phase. The matrix is a format for presenting the results of the LFA as a process, and is developed on the basis of the LFA tools applied earlier during the analysis phase.

The matrix can also be used as a basis for more a detailed workplan and to determine what resources are needed.

### 3.2.1 LOGICAL FRAMEWORK MATRIX

The logical framework matrix (LFM) lays out key aspects of an operation.

It provides a summary of the key information on the project and an easy overview that allows a quick assessment of the consistency and coherence of the project logic, and facilitates the monitoring and the evaluation. The method consist of an analytical process and a way of presenting the



**Figure 2.9: Water and sanitation coverage map. B: phase 2, response to a population displacement.**

	Intervention logic	Objectively verifiable indicators	Sources of verification	Risks and assumptions
General objective/ <i>Goal</i>				
Specific objective/ <i>Project purpose</i>				
Results/ <i>Outputs</i>				
Activities		Means	Costs	
<i>Inputs</i>				Preconditions

**Figure 2.10: Logical framework matrix.**

results of this process, which make it possible to set out systematically and logically the project / programme objectives and the causal relations between them, to indicate how to check whether these objectives have been achieved and to establish what assumptions outside the scope of the project may influence its success.

The LFM (Figure 2.10) should not be seen as simply a set of mechanistic procedures, but as an aid to thinking and framing the project designer’s ideas into a coherent plan of action. Using the tool can help to create an organised, comprehensive and well thought-out project.

Developing the LFM is not easy, and requires time and training. Beneficiaries and other stakeholders must also be involved in this process.

Logical framework analysis is a dynamic, iterative process, which should be reassessed and revised as the project itself develops and circumstances change.

*The LFM is comprised of 16 ‘boxes’: four columns and four rows. Within the vertical logic of the matrix, following the first column which represent the project strategy, it can be identified what the project intends to achieve and how (clarifying the causal relation between the different levels of objectives), specifying important underlying assumptions and risks (fourth column of the matrix). Within the horizontal logic of the matrix indicators to measure progress and impact are specified and the sources of information or means by which indicators will be verified (Introduction to the LFA, Adam Walsch, 2000).*

### 3.2.1.1 Parts of the matrix

#### *Intervention logic*

This corresponds to the first column of the matrix and it displays what the project intends to achieve, and how, by clarifying the causal relations between the different levels of objectives or project strategy.

#### *General objective/Goal*

The *General objective/Goal* describes the large-scale goal to which the project will contribute together with other projects or actions, but which cannot be achieved by the project alone.

#### *Specific objective or Project purpose*

The *Specific objective/Project purpose (SO/PP)* is normally the first piece in the LFM and is the key reference point of the project. The SO/PP is defined in terms of the benefits or the immediate

impact upon project beneficiaries as result of the project services. The SO/PP must clearly state the desired change, where the change will take place, and the magnitude of the change to be achieved.

The achievement of the SO/PP should depend on the team responsible for the project and also on the beneficiaries involved in order to ensure sustainability of the services.

The following advice is given regarding the project purpose:

– It is recommended to develop only one specific objective per logical framework matrix. More than one matrix may be needed for a more complex project.

– Objectives should be set such that they are achievable within the time and resource constraints of the project. The matrix inputs should describe the desired outcome and not the process or activity for achieving the result. Terms such as “guaranteed” or “assured” can be difficult to achieve in some programmes and should be used carefully.

### *Results/Outputs*

The *Results/Outputs* describe the services to be delivered to project beneficiaries. Outputs are the specific actions that achieve the SO/PP, and they are the product of the *activities* undertaken.

*Note.* – It is important to distinguish between results, activities and indicators. Results statements should describe the change in the service provided and they will be the effect produced by the proposed activities: For example, ‘100 latrines constructed’ it is not a result, it is an activity, and the result of this activity will be ‘Better access to sanitation services’. Indicators of the results should be chosen for measurement of the result. In this example, the result will be ‘1 500 people have access to latrines, and use them’.

### *Activities*

Activities are how the services of the project will be delivered, the things that must be done to achieve the results.

Some recommendations on presenting the activities are:

– Activities should be presented with the corresponding result.  
– Activities should be expressed in a tangible way, and should be achievable within the project timeframe.

– While activities are tangible, flexibility is also important. For example ‘Construct 10 water points’ allows the type of water point to be chosen during project implementation whereas ‘Construct 10 wells’ precisely defines the type of water point and may not be appropriate. It is easier to justify changes in the activities in the implementation phase than changes of results or specific objectives; however, it is necessary to understand how changes can affect the project in terms of timing, budget, human resources etc.

### *Vertical logic*

Within the vertical logic of the LFM the indicators to measure progress are specified and the sources of information and means by which indicators are to be measured are identified. In the last column, the risks and assumptions concerning the project are presented.

### *Objectively verifiable indicators*

Objectively verifiable indicators (indicators) are parameters used to measure, state and check how the specific objectives, results and activities have been achieved. They are important for monitoring the project. Indicators can be qualitative or quantitative.

*Note.* – It is important to distinguish between the indicators discussed earlier that serve to characterise a situation and the indicators that measure actions undertaken. Indicators of the situation are parameters used to define a specific quality or state and they are used mainly in the identification phase (i.e. water-quality parameters). However, objective and results indicators precisely express changes brought about by interventions (e.g. ‘water supplied will have between 0.4 and 0.6 mg/l of residual free chlorine’).

Before defining an indicator, it is necessary to verify the feasibility of measuring it. For example, diarrhoea morbidity can be difficult to measure by a water and sanitation project if the health care system does not include proper monitoring.

Some activities, results and specific objectives may require more than one indicator, as one may not provide enough information to assess progress.

Indicators must be “SMART” (Roche 1999):

- *Specific*: with regard to quality, quantity, target group, time / period, and place.
- *Measurable* (direct or indirect) and *unambiguous*: they must be precisely defined through objective data and their measurement and interpretation should be unambiguous.
- *Attainable* and *sensitive*: they should be achievable by the project and sensitive to changes the project aims to make.
- *Relevant and easy to collect*: the indicators chosen should be relevant to the project in question, and it must be feasible to collect information on them at reasonable cost.
- *Timebound*: indicators should describe by when a certain change is expected.

Indicators may be direct or indirect. Direct indicators are related to a directly observable change and indirect indicators are indirect consequences of this change. For the result ‘Water access improved’, a direct indicator could be ‘100 families have access to improved water points’, and an indirect indicator could be ‘More children attend school’ (because they spend less than 15 minutes collecting water and this leaves them time to go to school).

Specific objectives/results can focus on capacity building or behaviour change. In these cases, indicators are mainly qualitative. However, they must still be rigorous. For the result ‘Water department capacities’, ‘Number of people attended training’ is not enough as the only indicator because it does not demonstrate change. ‘10 technical staff have improved their knowledge on water-point maintenance’ should complement the first indicator. Although ‘improved knowledge’ is qualitative it is a measure of progress.

### *Sources of verification*

*Sources of verification* (also called *means of verification*) indicate how, where and in what forms the required information on the achievement of SO/PP and results can be found.

Sources of verification must be trustworthy and accessible, and they must provide the information required to verify the chosen indicators. They include official or private reports and evaluations, internal surveys and reports, technical surveys and reports. Cross-checking information from different sources is recommended for certain indicators.

Means of verification must indicate the source (project records, official statistics etc.), which provides the information and how regularly it should be provided. The work and cost of collecting and analysing information must be assessed and covered by the project.

Examples: KAP surveys can be the source of verification for indicators of hygiene-behaviour changes, water-quality analysis can be used to verify improvement in the quality of the water etc.

### *Means and costs*

*Means* are the human, material and service resources (inputs) needed to carry out the activities. *Costs* are the financial resources needed to carry out these activities.

Activities must be detailed with the required means and costs (instead of indicators and sources of verification). Some logical frameworks have the means and the costs separated from the activities, in another line called ‘inputs’.

### *Risks and assumptions*

*Risks* are key events, actions or decisions upon which project success depends, which may be subject to delay or which may not materialise. They are not supposed to occur, but there is a probability that they might.

*Assumptions* are external factors outside the immediate control of the project, but crucial for the achievement of activities, results and objectives. The aim of specifying assumptions (and pre-conditions) is to identify and assess potential risks to, and dependencies of, the project right from initial stages of the project design, to support the monitoring of risks during the implementation of the project and to provide a basis for necessary adjustments. It is important to identify the assumptions at each level of the logical framework analysis.

Some assumptions can be identified during the analysis phase as objectives included in the objective tree. Those objectives are not achieved by the project but they can be important for achieving the purpose of the project. For example, a nutrition project may have 'improved nutritional status of the population' as its purpose, in a context where this may only be achieved on the condition that a complementary water project achieves its specific objectives. One of the assumptions behind the nutritional project therefore may be that this condition is met.

Other examples are: 'access to water will be guaranteed, assuming that there is no sabotage of the transmission line of the water system', or 'capacity in the region will be improved, assuming that the authorities continue to participate in training', or 'a system can be built in a specific area, assuming that access to the area is guaranteed'.

There are different levels of assumption depending on their relevance to the project. If an assumption for success is unlikely then the project should be redesigned. If it is sure, or almost sure, that it will occur, then it is not necessary to include it in the logical framework.

#### *Preconditions*

A precondition is a condition that must be satisfied before the project starts.

Examples: 'an end to the conflict allows access to the area', 'communities agree to participate in activity implementation' or 'local authorities respect signed agreements and agree to collaborate'.

#### *3.2.1.2 Construction of the logical framework matrix*

The strategy chosen for inclusion in the project is transposed to the first column of the matrix (logic of intervention): going back to the objective tree is a helpful at this stage (see Figure 2.11). The first step is to define the *specific objective* of the project, then transpose the rest of the levels. The project strategy incorporated in the *logic of intervention* has to be reviewed to see whether the *means-to-ends* relations between the different levels are consistent and what is remaining to complete this logic.

The next steps consist of developing key indicators, means of verification (except for the activities, where resources and budget must be included instead) and assumptions for each level, as well as the preconditions to start the project. A complete example of a logical framework matrix is shown in Figure 2.12.

#### *3.2.1.3 Checking the logic of intervention*

Once the matrix is developed, it is important to check the logic of the LFM from the bottom to the top (to see if it is coherent) as show figure 2.13.

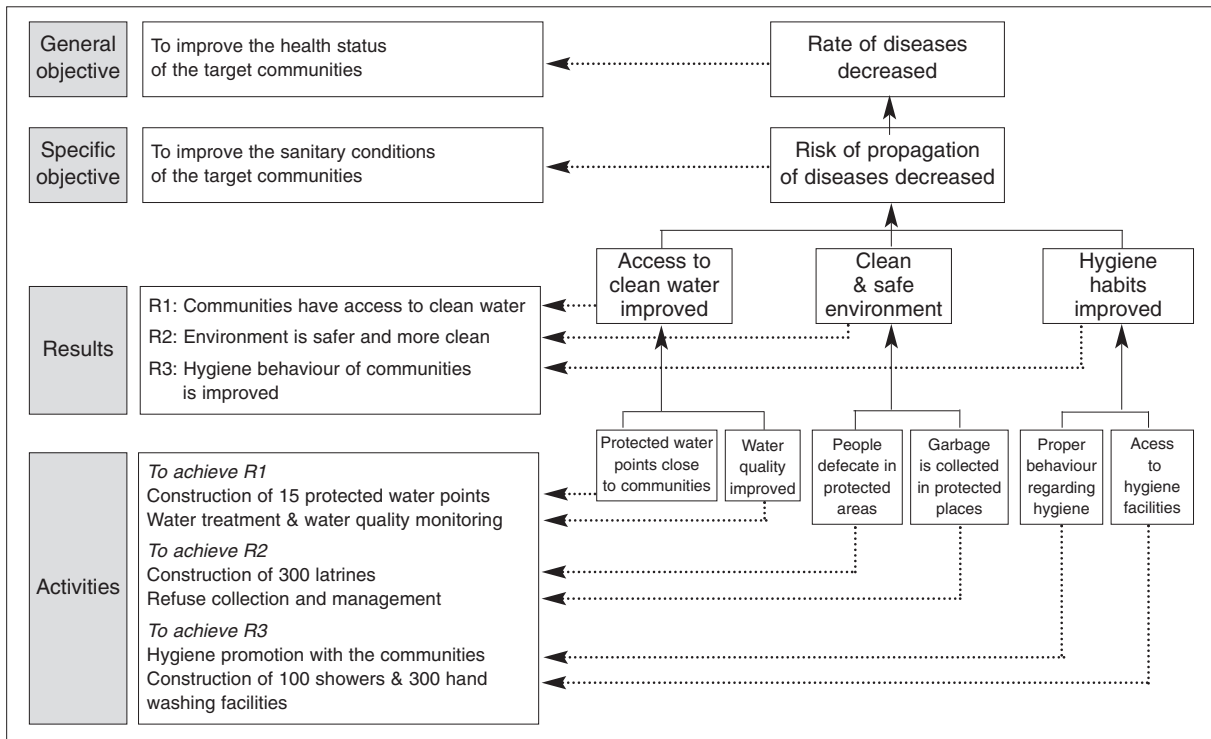
### 3.2.2 ACTIVITY (WORK-PLAN) AND RESOURCE SCHEDULING

The activity schedule (work-plan) determines the sequence of activities, estimates their duration, sets milestones and assigns responsibilities.

Making work-plans mainly consists of:

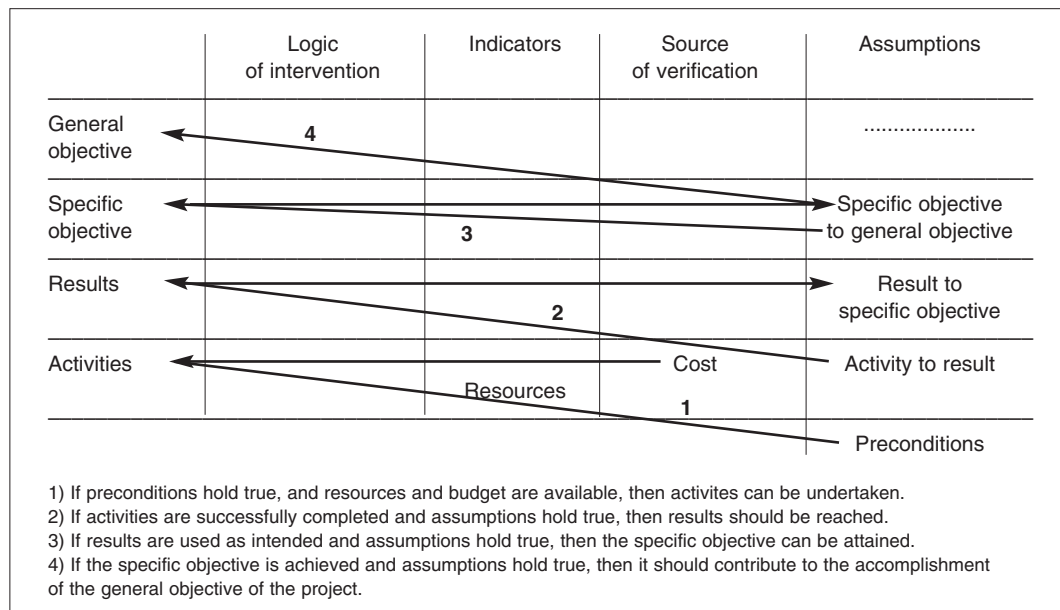
- Listing the envisaged project activities.
- Breaking down the activities into manageable tasks.
- Establishing the sequence of implementation.
- Estimating the duration and start and completion dates of each activity.





**Figure 2.11: Construction of the logical framework matrix from the problem tree.**

**Figure 2.12: Example of a completed logical framework matrix.**



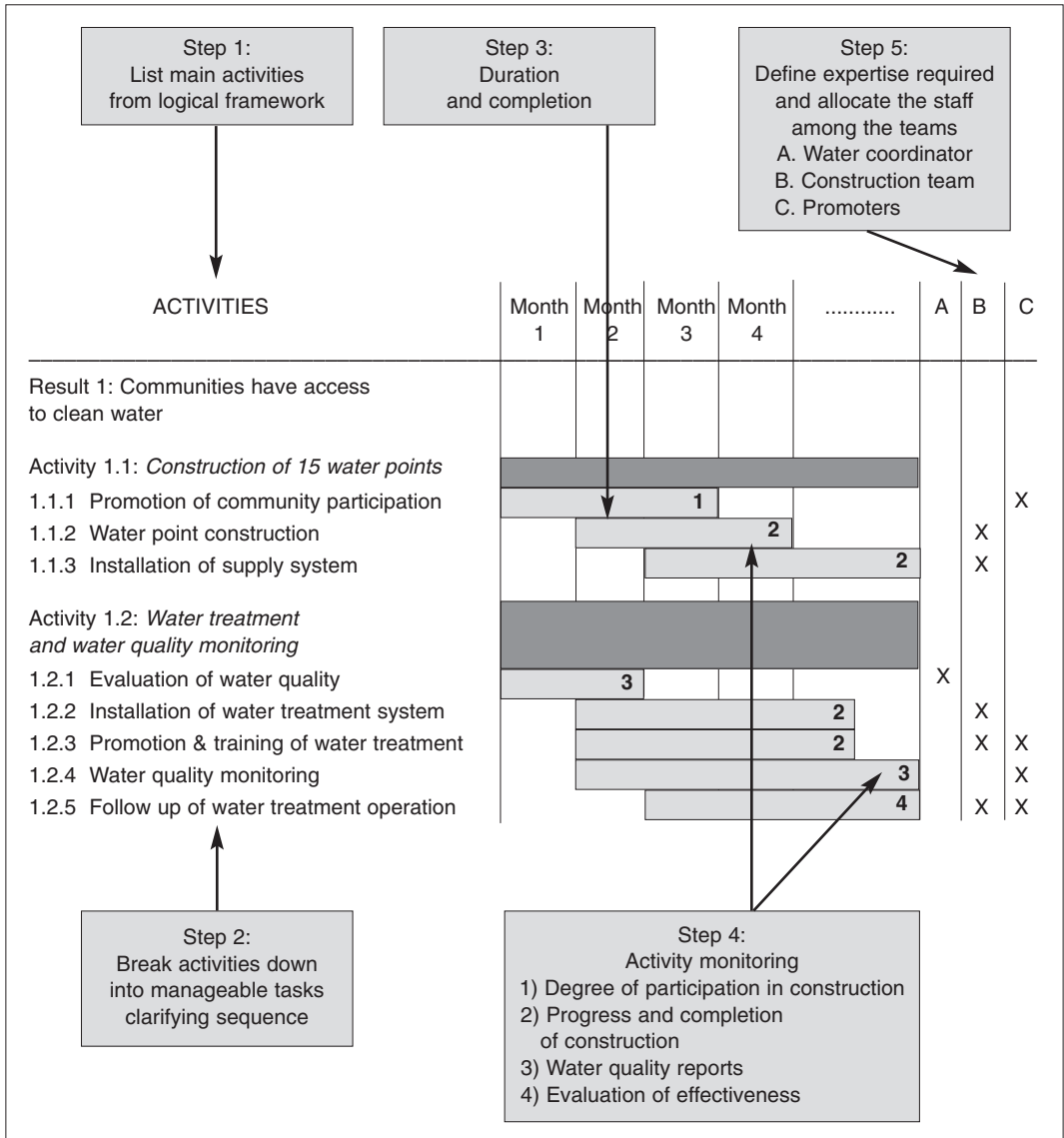
**Figure 2.13: Checking the logic of intervention.**

	LOGIC OF INTERVENTION	OBJECTIVELY VERIFIABLE INDICATORS	MEANS OF VERIFICATIONS	ASSUMPTIONS	
GENERAL OBJECTIVES	Incidence of water and sanitation-related diseases reduced	Mortality and morbidity rates are reduced to be those for a normal situation	Health assessment Health centre records		
SPECIFIC OBJECTIVES	Sanitary conditions improved	100% water and sanitation coverage for the target communities Disease transmission routes (via water, excreta and refuse) reduced in the 3 communities	Internal report External evaluation Sanitary evaluation	Medical programme developed by X is effective No existence of an epidemic outbreak Vulnerability of communities will not increase due to food shortages or other crises	
RESULTS	R1: Communities have access to clean water	15 litres of clean water available per person per day 0 faecal coliform/100 ml. and 0.4 mg/l of free residual chlorine in supplied water	Project report Water quality report Sanitary assessment	Arrival of new people will not be the cause of an epidemic outbreak	
	R2: Environment is more safe and clean	1 latrine available per family Each family has and uses a refuse pit One community refuse bin per 10 families	Sanitary assessment Evaluation report	Upland farmers abide by agreements and do not use pesticides or contaminate the water	
	R3: Hygiene behaviour of communities is improved	All the teachers are trained and they include hygiene promotion in their programmes Communities improve their awareness regarding hygiene People use handwashing facilities and showers	KAP surveys Programme reports	No new external vectors cause new diseases	
		MEANS	COSTS	ASSUMPTIONS	
ACTIVITIES	<i>To reach the R1:</i> 1) Construction of 15 water points  2) Water treatment & water quality monitoring	Construction equipment Construction materials Transport Treatment systems Treatment consumables Water analysis kit & consumables	30 000 € 45 000 € 5 000 € 10 000 € 2 000 € 5 000 €	No sabotage of the water facilities Natural disaster will not destroy the facilities Communities have access to facilities Communities maintain motivation & awareness of the promotion done Administration follows agreements regarding the maintenance of the existing water points and construction of new water points and latrines Water communities maintain water and sanitation facilities correctly Water points will not dry up	
	<i>To reach the R2:</i> 3) Construction of 300 latrines 4) Refuse collection and management	Construction materials  30 cans Tools 5 donkey carts for refuse collection	30 000 €  2 000 € 3 000 € 3 000 €		
	<i>To reach R3:</i> 5) Hygiene promotion to target communities 6) Construction of 100 showers and 300 hand-washing facilities	Teaching materials  Construction materials 200 litres water tanks and taps	10 000 €  15 000 € 6 000 €		
COMMENTS	Means and costs include: staff, transport, housing, communication, assessment and evaluation (this list is not comprehensive), but exclude indirect cost, such as administrative costs, which should be not in the logical framework matrix. A detailed breakdown of costs should be in the budget, not in the matrix. The total cost of activities must be within the budget.				<i>Preconditions</i> Voluntary participation of beneficiaries in the project Access to equipment and materials Security in the area to allow the implementation of the project

- Defining the monitoring tools and procedures.
- Allocating tasks among the teams.

The work-plan is fundamental to the monitoring of the project. It is important to include the monitoring tasks, as these will also be essential for the evaluation at the end of the project.

An example work-plan is presented in Figure 2.14.



**Figure 2.14: Example of an activity schedule (work-plan).**

Resource scheduling is developed from the work-plan, and details the financial, human and physical resources required to carry out the project. It is also important to include indirect costs (such as administrative costs required by the agency to maintain its structure and capacity).

The evaluation of the project costs by donors will have significant influence over the project appraisal and approval.

Figure 2.15 shows an example of a resource schedule.

### 3.3 Proposal writing

Once the project is defined and it is determined that donor funding is needed, it is necessary to write a proposal. Each donor organisation has its own proposal guidelines and formats. However,

Activities/ Resources	Unit	Quantity per period				Cost per unit	Fund. source	Code	Schedule cost				Total cost
		Q1	Q2	Q3	Q4				Q1	Q2	Q3	Q4	
Construction of 15 water points													
Equipment													
Well tripod	unit	2	...	...	...	400 €	ECHO	B 67-A	800 €				800 €
Ring moulds	unit	4	...	...	...	300 €	ECHO	B 67-A	1 200 €				1 200 €
Tool set	kit	2	...	...	...	300 €	ECHO	B 67-A	600 €				600 €
Handpumps	unit	3	4	4	4	700 €	DFID	C 42	2 100 €	2 800 €	2 800 €	2 800 €	10 500 €
Materials													
Cement	20 kg	130	130	130	130	25 €	ECHO	B 67-B	3 250 €	3 250 €	3 250 €	3 250 €	13 000 €
Reinforcing bars	12 m	240	320	320	320	3 €	ECHO	B 67-B	720 €	960 €	960 €	960 €	3 600 €
Salaries & allowances													
Masons	month	16	16	16	16	300 €	ECHO	B 27	4 800 €	4 800 €	4 800 €	4 800 €	19 200 €
Pump installer	month	1	1	1	1	300 €	DFID	D 32	300 €	300 €	300 €	300 €	1 200 €
Labourers	month	20	20	20	20	200 €	ECHO	B 27	4 000 €	4 000 €	4 000 €	4 000 €	16 000 €
Team leader	month	4	4	4	4	500 €	ECHO	B 27	2 000 €	2 000 €	2 000 €	2 000 €	8 000 €
Transport													
Car rent etc.	month	8	8	8	8	300 €	ECHO	B 85	2 400 €	2 400 €	2 400 €	2 400 €	9 600 €

**Figure 2.15: Example of a resource schedule.**

the proposals will be essentially similar, whatever the donor concerned. An example of a proposal structure can be found in ECHO's guidelines ([www.echo.org](http://www.echo.org)).

### 3.4 Project approval and financing

There are several types of entity which fund projects, including national and international aid departments (such as ECHO (European Commission Humanitarian Office) DG (Directorate General, European Union), DfID (United Kingdom Department for International Development) etc.), regional and municipal governments, associations, businesses and NGOs. Each has its own guidelines and procedures for project approval and financing.

Project approval and financing involves a range of discussions between donors and implementing agencies before signing a contract. Participation of the donor in proposal making depends mainly on their strategy. Budget negotiation is one of the main issues.

Timing for approval of the project mainly depends on the availability of funds and agreements with other stakeholders. Emergency funds are normally assigned quickly.

Once the project is approved, funds come in at established times or on completion of agreed outputs. Once funds are allocated and contracts are signed, the project starts. The implementing agency regularly communicates with the donor through periodic progress reports.

## 4 Project implementation and monitoring

Project implementation and monitoring are the core stage of a project. Resources are mobilised and activities are carried out with the aim of providing beneficiaries the planned services.

This chapter can not develop all aspects related to the implementation phase; many of them are developed in other chapters of the book. This section describes some important issues related to the management of the activities developed during the project: planning of activities, staff management, internal procedures, security and safety awareness, community involvement, and management of information collected.

Implementation corresponds to the activities defined in the logical framework. Common activities in water and sanitation programmes include: construction and rehabilitation of infrastructure, provision of supplies, training and health promotion activities, studies, and assessments. Monitoring is also required. For example, the implementing agency should check back periodically to ensure that the handpump installed is properly used by the beneficiaries and is covering their needs. The reason for this monitoring is 1) to ensure the implementing agency is properly carrying out its work, 2) to be sure the planned activity is adequate, 3) to answer any questions that beneficiaries have which were not addressed in the initial intervention and 4) to be sure that training is adequate.

Many aspects of a project need to be actively managed. During implementation, and in consultation with beneficiaries and other stakeholders, the project-management team assesses actual progress against planned progress to determine whether the project is on track towards achieving its objectives. If necessary, the project is re-oriented to bring it back on track.

Monitoring is a system to collect, analyse and use information to verify that the project stays on track towards the achievement of its objective. Monitoring will measure the level of accomplishment of the planned activities, but it is also a larger concept that involves evaluation of the degree to which results are obtained and objectives are reached during the different phases of implementation.

## 4.1 Planning

Planning is the first step of project implementation, and is an essential tool that ensures that all project activities are considered and scheduled.

Planning project implementation consists of review and further development of the work-plan and resource schedule which were drawn up at the end of project identification.

When planning project implementation, the following points must be taken into account:

– Humanitarian context (emergency, refugees or internal displacements, post emergency etc.): planning will not be the same in all contexts, and depends a great deal on the severity of the situation.

– Programme duration: the implementation time is initially defined when making the proposal. Extensions and amendments can be negotiated with the donor if the context changes between writing the proposal and starting implementation (if the funding decision causes a delay), or during implementation (if delays in implementation can be justified).

– Human and financial resources.

– Security situation: if the project area is unsafe for any of the staff, this factor must be taken into account in the plan as well as in the working methods.

– Project participants' availability: some people from the communities involved in the project may be away for part of the year (e.g. in Guatemala, the farmers from the area of 'El Altiplano' leave their villages and go to the coffee plantations to work as casual workers for the harvesting season). Activities must be scheduled taking into account periods when community labour is not available.

– Rainy season: some countries are affected by a heavy rainy season for several months of the year, including countries like Myanmar which experience monsoons. Reaching remote communities and conducting field work like drilling boreholes may be impossible during several months.

– Technical constraints: these issues include variation in yield of water sources, such as springs and rivers, which may be very significant between the rainy season and the dry season. The choice of the source, which is made on the basis of the water demand and, in some cases, distribution-network calculations, must be based on lower flows. The water table in a borehole may drop during the dry season and this must be accounted for when setting pump depth. Other technical constraints include difficulties in prospecting for, and reaching, groundwater, inappropriate national or regional technical policies etc.

– Political context: external events can delay the implementation of the programme. Some, such as elections, can be forecast, but others cannot.

– Collaborating with counterparts (local/international NGOs, universities, local authorities etc.) may require time at the beginning (making contact, presentation, training and organisation) but is essential for proper project implementation in terms of sustainability, time efficiency, and programme effectiveness. Given these elements, planning must be as participatory as possible and must involve all the people and entities affected by the project.

## 4.2 Staff management

Staff require administrative and operational management. The number of staff and the structure of the team vary according to the context, the nature and size of the project, the degree of involvement of beneficiaries and other stakeholders, and staff competencies. Emergency responses usually require a high number of staff; however, this also depends on the context and the degree of beneficiary involvement.

### 4.2.1 CREATING THE TEAM

Creating a project team is one of the first steps in implementing a project and it is fundamental for its development.

– A flow chart should provide a clear picture of staff structure and the relationships among the different positions. Common positions include: administrators, managers, technicians and logisticians, among others. Each position requires a different set of skills.

– A job description needs to be created for each position, including:

- Name of the position.
- A brief description of the project.
- Responsibilities of the position. It may be appropriate to include specific tasks and activities to be achieved. However, the programme manager should be aware that when many specifics are included it can be difficult to alter the responsibilities if required as the project adapts to the context.
- Location of work and working hours.
- People to manage, person who supervises this post, co-ordination and reporting responsibilities.
- Other work conditions: salary, holidays etc.

– Following the creation of a job description, a job vacancy is posted, first internally and then among other NGOs, universities, institutions, on the radio and in newspapers etc. Applications and curriculum vitae are received from candidates.

– Candidates for the post are chosen and interviewed. Interviews aim to check if the information given on the curriculum vitae is accurate, to obtain additional information, and to present the organisation, objectives and activities. The methodology used is mainly open discussion and, for certain positions, a written test. Interviews should be conducted by the immediate supervisor and other appropriate staff.

– Once an appropriate candidate is selected and the job has been offered and accepted, a contract (for a specific duration) and work regulations are signed.

– The new staff person should be appropriately briefed and introduced to the organisation.

– Periodic review of staff needs, the staffing structure and the organigram should be undertaken.

### 4.2.2 THE ROLE OF THE PROJECT MANAGER

The project manager is responsible for the overall management of the project, and can also be involved in the strategy of the organisation at the country or regional level, participating in coordination bodies, conducting new assessments, defining new projects etc.

Overall management involves: human-resources management; collaboration and coordination with local or international NGOs, institutions and local authorities; capacity building; budget monitoring; material and equipment orders; budget and supply forecasting; equipment maintenance; data

collection and analysis (assessment, monitoring and evaluations); reporting; institutional learning; investigation; development; security; strategy; project definition; integrated approach with other technical departments; gender issues; environmental issues; and any other points that come up.

In the area of human resources, project managers are in responsible for:

- defining human-resources needs for the project, preparing job descriptions and organigrams; and recruitment if needed;
- organising staff trainings and meetings;
- leadership, motivation and communication;
- organisation and supervision of the team;
- evaluation of each person in the team.

A sample water and sanitation project manager job description is included in Annex 4.

#### 4.2.3 LABOUR RELATIONS AND CONTRACTS

There are several ways to hire people to conduct work:

– *Regular staff*: these people are full employees with standard employment contracts which must follow the national laws and guarantee benefits such as insurance, holidays, sick leave, end of contract compensation etc.

– *Casual workers*: these people are paid daily and are normally under informal contracts or no contract at all. A letter of understanding is recommended to establish engagements, and the organisation must take the responsibility to cover the worker if an accident occurs.

– *'Food-for-work' casual workers*: food-for-work can be an option in situations where food aid is needed, where people are paid in food for work that is generally considered to be the responsibility of the community. This type of payment is usually made in situations where food aid is deemed necessary and labour is available. It is necessary to do a proper food-security analysis before implementing these activities, to ensure that:

- local food production is not in danger due to the food aid;
- the food-for-work programme is adapted to the needs of the beneficiaries;
- voluntary work is not discouraged.

– *Sub-contracting*: a complete activity can be subcontracted to a company, to a group of people or to another organisation. The contractual relationship must be established correctly, and payment for the services provided must be dependent on the quality of the work.

One problem associated with subcontracting is that community participation becomes more difficult, as subcontractors normally do not have a social agenda. Subcontractors may also economise too much on money and time, which can lead to a drop in the quality of work. On the other hand, contracting out work can be the best way to make use of good professionals and relieve the project of many management and logistical tasks.

A common problem in project design is that personnel budget lines are often inflexible, whereas subcontracted activities or casual workers can be assigned under the activity implementation budget lines. However, if budgetary problems are the primary reason for subcontracting or using casual workers, it is preferable to renegotiate the budget to increase the personnel budget lines. This ensures that personnel are under regular contracts and enjoy social labour rights and other advantages. It is also preferable to employ staff as there is more opportunity for capacity building.

#### 4.2.4 SPECIAL MANAGEMENT TASKS

##### *Training*

Training of staff serves the project, the organisation, and the team members. A skilled, autonomous, motivated and responsible team is essential for reaching the objectives of the project and build sustainability.



Training can be developed in two ways:

- Continuous training: day-to-day work and communication enables constant transfer of skills and knowledge.
- Specific organised training: this may be undertaken on specific topics according to the needs of the programme and the capacity of the staff.

It is important to design a training plan, where objectives are defined over a distinct period of time. The first steps are to evaluate personnel capacities and expectations. Staff should be involved in setting the training agenda and it is important to consider the professional growth of each staff member.

Training topics range from technical (e.g. borehole drilling, hygiene promotion, community mobilisation) to administrative (e.g. warehouse management) to organisational (e.g. strategy formulation). Training can also be focused on humanitarian issues, such as human rights etc., and can be a way to involve staff in the organisation's principles and mandate. Other training can be aimed at reinforcing specific skills such as languages, computer use, mathematics, literacy etc.

Training should be evaluated to measure its impact, improve future trainings and provide ideas for other subjects for training. If several training sessions are held with the same group, each session can include a review of topics covered in previous sessions and the opportunity can be taken to evaluate the training.

Staff training can be internal or external, in seminar format or as a practical demonstration. Training can be carried out locally, nationally or regionally and for an individual or a group.

#### *Coordination within the team: organisation and supervision / meetings*

Team management requires respect, flexibility, clear rules, fairness, transparency, communication (understanding, listening and access to information), leadership, availability, delegation, and no discrimination.

Frequent meetings ensure good communication within the team and the organisation.

It is important that delegating responsibilities is done with appropriate control and supervision. Conflict resolution is another important issue in staff management.

#### *Evaluation of personnel*

Evaluating the performance of each staff member is important for the person, the project and the organisation. Evaluations should be conducted as an open discussion between the supervisor and person being evaluated. An evaluation form should be used, containing both general criteria (e.g. contact with local population, with authorities, respect of the organisation's rules, commitment to the project etc.) and specific criteria (technical, managerial etc.). Evaluation objectives should be fixed at the beginning of the employment contract (professional behaviour, understanding capacity or technical basis etc.).

Staff evaluations should be constructive and honest. They must always be done together with the person concerned, who should have the freedom to express their agreements or disagreements. If there are different points of view, they must be explained. Both people should read the completed evaluation form and sign it upon completion. One copy of the completed evaluation form should go to the staff member and another should be put in their personnel file.

It is also useful to have bottom-up evaluations of managers by the people they manage as well as top-down evaluations of staff by their managers, to help to improve management relations and avoid possible problems.

### **4.3 Internal procedures**

The organisation must be ruled by clear and transparent procedures to guarantee fair and smooth operations.

- Administrative procedures should exist for:
  - use of funds;
  - cash management, money and supply forecast, orders and budget monitoring;



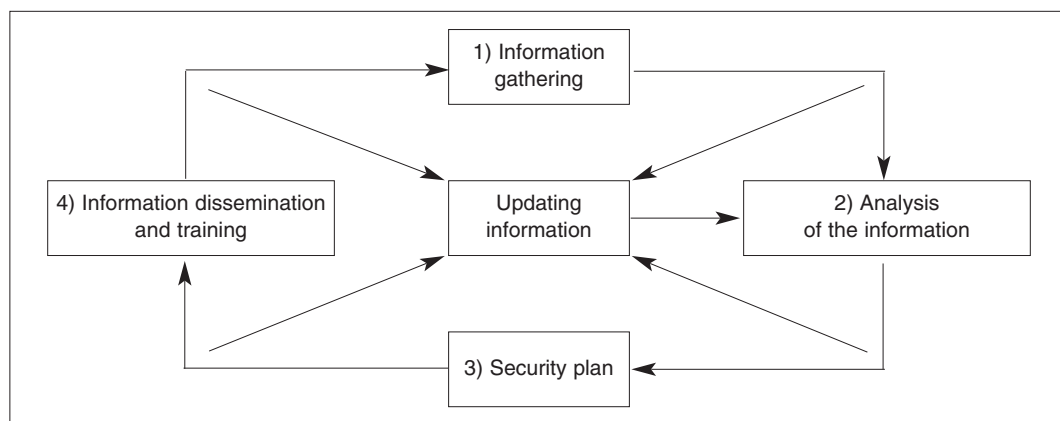
- agreements with other organisation or institutions;
  - staff management (recruitment, contracts, staff regulations, meetings, working hours, evaluations etc.).
- Logistics procedures should exist for:
- orders, quotations, purchases;
  - stock management (in/out, storage);
  - use and maintenance of material and equipment (spare parts, maintenance and repairing procedure);
  - transport of material and equipmen;
  - use and maintenance of vehicles (weekly planning);
  - radio, phone and e-mail communications (the security situation will determine many of these procedures).
- Security procedures: staff movements, working hours, hours in the field, places to go and not to go, communication etc. (see Section 4.4).

## 4.4 Security and safety awareness

Security and safety must be a priority for humanitarian programmes and interventions should not take place (or must stop) if security and safety are not guaranteed.

Humanitarian interventions often take place in areas with serious security considerations. ‘Security’ refers to the risks of conflicts or intentional violence. Establishing security procedures requires a good understanding of the situation. Security must be a priority for all the members of the team and a security plan must be established and continuously updated with clear and understandable guidelines and rules (see Figure 2.16). This requires that the programme manager does the following:

- Obtain and collect reliable information.
- Maintain close and continuous contact with local communities and key informants.
- Analyse trends, risks and vulnerabilities related to security.
- Have and respect the security plan.
- Ensure all team members follow the rules and respect the decision-making mechanisms and the people responsible for security.
- Communicate and train staff on the procedures and what to do in case of emergency.
- Ensure that all staff demonstrate good behaviour with the communities and other actors.
- Maintain neutrality in a conflict.
- Respect the local social structure and decision-making mechanisms.



**Figure 2.16: Process for developing a security plan.**

- Involve the communities in the security of the team and the project assets.
- Continuously evaluate the organisation’s capacity to respond to security problems.

Security must be taken into account from the early stages of the project cycle as a fundamental characteristic of the context in order to properly define the project. It is also essential to plan appropriate resources and time in the project design to ensure security throughout the project. Security is the first priority in the field. If it is not guaranteed, the project must be stopped or not implemented.

‘Safety’ refers to risks associated with natural events and work activities, as well as accidents related to daily activities, and medical problems of the staff. Safety procedures are aimed at reducing vulnerability from such occurrences, and require the following:

- Safe working practices, including:
  - having a set of safety regulations and provision of safety equipment;
  - awareness and training about hazards and regulations;
  - team members taking responsibility for ensuring the safety of themselves and others;
  - having procedures in case of accident, and basic medical kits;
  - having insurance cover for workplace accidents, which meets legal requirements as a minimum.
- Choosing, designing and constructing facilities which guarantee the safety of the communities during their use. (e.g. avoiding open wells without any protection in schools, building fences, protecting wells to prevent accidents during standby in construction etc.).
- Involving communities in their own safety during construction and use of facilities upon completion:
  - protect against any community member disturbing the construction site, endangering themselves, others, the equipment or the facilities;

**Table 2.VI: Safety measures for some water and sanitation activities.**

Activity	Measures
Construction / rehabilitation of wells: people falling in, tools and equipment falling in, collapsing soil, accidents with pick-axes and hammers, accidents with electrical dewatering pumps (broken electrical cables), poisonous gases from pump engines or explosives	Use safety equipment: helmets, boots, gloves, harnesses, good-quality lifting and lowering equipment (tripods, pulleys etc.) to lower rings Reinforce walls in areas at risk of collapsing Keep people out of water when using an electrical pump Use compressed-air-powered equipment rather than electrical pumps for dewatering Monitor the availability of air at the bottom of the well and ensure enough for people inside Do not use engines inside the well, to avoid gases Cover and protect the well during standby periods
Drilling: equipment falling, accidents with the drilling rig, burns from motor parts, compressor tubes with no security connections	Use safety procedures and equipment (helmets, gloves, boots, safety glasses, ear defenders) Limit access to the area where equipment is placed
Use of chemicals: water treatment and analysis	Use gloves and safety glasses, especially for procedures which use methanol for disinfecting water-analysis equipment Use appropriate masks when handling dusty or volatile treatment chemicals Store and transport chemicals safely
Accidents with vehicles	Proper maintenance, following rules

- put the community in charge of the worksite and safety equipment during non-working hours;
- ensure that communities understand that they are responsible for the facilities once the work is finished, and this involves safety (maintenance of the safety barriers, ensuring that other members of the community are aware of risks etc.);
- establish responsibilities through signed contracts with communities upon project inception.

Table 2.VI describes some activities related to water and sanitation projects that require special attention to safety.

## 4.5 Community involvement

Successful implementation and sustainability of a project depends directly on full support from the beneficiaries. Communities must appropriate the project and its outputs. This is only ensured if they are involved in all phases of the project – from the early stages of project definition to implementation, operation and maintenance. Beneficiary input is also essential for project evaluation.

Participation of communities in the project design (i.e. choice of water source, technology used, level of service and placement of facilities) helps to prevent:

- social problems such as unfair distribution of facilities, loss of access to the resource for certain people/groups, change of social habits (e.g. rivers, public water points and laundry areas are important places where women meet and so installing individual water points may have a negative impact on the social structure);
- technical problems such as technology that is not appropriate to the community's needs or lack of knowledge and resources for operation and maintenance of the system.

Community participation serves to motivate people, develop local capacities and reduce the cost of construction. The sense of ownership is also important to guarantee sustainability.

Communities can participate in the project in different ways: by paying part of the cost of construction, collecting materials (sand, gravel, water etc.), or participating actively in construction. Beneficiaries should also take on responsibilities in the project, such as looking after the facilities, ensuring the safety of the community during the work, helping accommodate the teams carrying out the work etc. Involvement in the construction also benefits the operation and maintenance capacities (see Chapter 16 for more details).

Finally, the community will be involved in the hygiene-promotion programme which is necessary in all water and sanitation projects (see Chapter 15).

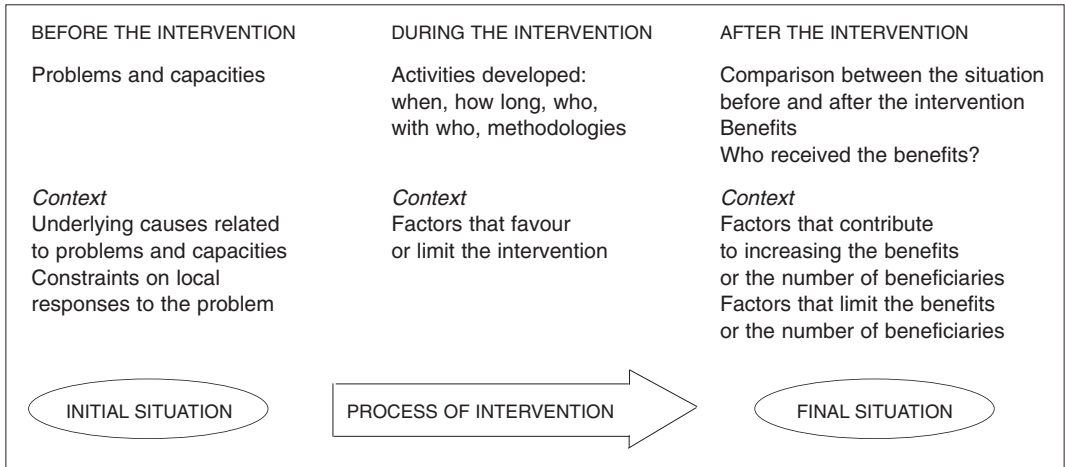
## 4.6 Management of information, lessons learned and reporting

During the development of projects, a large volume of information is gathered. This information, in addition to being used by the project designers, should be organised, analysed and transmitted to the other stakeholders at all stages. Distilling the information systematically is also necessary in order to capture learning in order to improve:

- Project evaluation: rather than waiting until the end of the project, there is a great deal to be learned throughout the project cycle by regularly processing the information gathered.
- Adaptive management: actions, methodologies, objectives, and strategies can evolve throughout the project in response to lessons learned.
- Comparative learning: information gathered can be compared at various scales such as local, regional, national and international to enhance learning.
- Capacity building and learning: information distilled can facilitate transfer of knowledge, improve skills and share successful experiences or lessons learned.

Access to the information gathered also facilitates transparency in project management.

Typical tools for information management and sharing include reports, publications and studies, databases, maps and geographical information systems.



**Figure 2.17: Selection and structure of information during the project.**

Reporting is essential to evaluate the progress of the project and also serves to communicate lessons learned to local authorities, institutions and donors. Reports are also the usual way to document project progress and a typical first step in discussing possible project changes with donors. There are different types of report:

- Internal reports (monthly, quarterly and/or annual) between project base and capital or capital and headquarters.
- Intermediate (often quarterly) and final donor reports (as stipulated in the contract).
- Special reports on specific issues.

Capitalisation of experience can be done in a participatory manner where stakeholders define the success, failure and innovation of certain project aspects. This information can be used to help define future actions.

Information should be selected and structured during all the project process. It is recommended to follow a methodology and prepare it systematically as described in Figure 2.17.

This participative capitalisation of a project implies:

- Evaluation of the need capitalise and what to capitalise.
- Identification of actors who should be involved in the process.
- Collection and classification of necessary information.
- Interview process.
- Description of the intervention.
- Reporting and forms.
- Communication of the results.

## 4.7 Monitoring

Monitoring concerns the analysis of project progress related to the situation and the changes which take place. It requires continuous information and data collection, and analysis and use of information for adaptive management and decision making. It applies to:

- An analysis of the evolution of the logical framework, mainly a focus on the results, resources and activities. Verification of relevance of objectives defined in the project.
- The progress of programme activities compared with the plan.
- Evaluating if the needs and constraints of the project are addressed and what changes of situation and needs require changes in the intervention.

- Evaluating the management of resources (financial, human and material) in relation to the definition of the project and the results obtained.
- Review of the implementation procedures to determine information needs at the different levels of the project-management structure. Essentially, this means matching information needs to decision-making roles.

Monitoring can be a great way to involve the community. Participatory monitoring allows communities to learn lessons and work with the team to make programme changes.

It is important to create a monitoring system that has clear objectives and that specifies the human and financial resources required and the responsibilities involved. A monitoring system should be simple and manageable. Steps in creating a monitoring system include:

- Selecting relevant indicators (relevant and easy to collect and to analyse, see SMART project indicators in Section 3.2.1).
- Defining the data collection method and the responsibilities of the people involved in those processes.
- Defining how the analysis will be presented, discussed with people involved and used to inform programme planning and adaptive management.

Monitoring and evaluation are two different activities, with different objectives, which may use the same information. Monitoring is progressive and more focused on project management, and evaluation in the project cycle aims to assess if the project has fulfilled its objectives and other aspects to consider for future interventions. Normally, monitoring feeds into evaluation.

## 5 Evaluation

Evaluation is a systematic way to review the achievements of a project against planned expectations and to use project experiences and lessons learned to design future projects and programmes. Evaluation can be defined as an assessment of the relevance, efficiency, effectiveness, impact, economic and financial viability, and sustainability of a project. Evaluation is based on the measurement of indicators (see Section 3.2.1).

Evaluation can either be internal (done by the organisation that implements the project) or external (done by someone who is not involved in the project). It is recommended that projects have external evaluations.

Evaluations require time and resources, and it is important to include the necessary time and resources in the initial project design and budget.

### Main criteria used for project evaluation

There are six main criteria used to evaluate a project:

#### *Effectiveness*

Degree of achievement of the specific objective defined by the project (comparison of the results achieved with the specific objective planned).

*E.g., 80% of the objective achieved: only 80% of the population have access to safe water after the project instead of the 100% expected.*

#### *Efficiency*

Efficiency measures the outputs/results (qualitative and quantitative) in relation to the resources (inputs): does the programme use the least-costly resources to achieve its objectives with quality in the context where it is implemented?

This generally requires comparing possible alternative approaches to achieving the same outputs/results to see whether the most efficient process has been used.

E.g., *other projects used local technologies for the pumping system, reducing the cost of this activity by 70% and improving sustainability.*

### *Impact*

Impact looks at the wider effects of the project: social, economic, political, technical, and environmental. It includes changes that are immediate and long-term, intended and unintended, positive and negative, and macro and micro.

Impact studies address the question: What difference has the project made to the beneficiaries?

Sometimes it is difficult to assess impact because there are several factors which can influence the results (the problem is to know to what extent the project affects the situation, taking account of the other factors) and also because a result can have several impacts.

E.g., *improved access to water had a positive impact in the economic status of the families: x% of the cost of water consumption was saved.*

### *Sustainability*

Sustainability refers to the impact of the project once it is completed and over a long period. It involves, in the long term, the proper use and the good condition of the facilities provided, the retention and use of the knowledge acquired by the beneficiaries during the project and the continuity of the community organisation developed by the project. Sustainability is tested through questions such as the following: Can more permanent actors continue achieving the programme objectives when this project stops? Do the host country and beneficiaries 'own' the programme, such that they have the motivation and capacity to continue it?

The main factors influencing sustainability are:

- financial and management capacities of the host institution;
- socio-cultural factors relating to the acceptability of the programme;
- technical factors: the appropriateness of the technology to the host institution's financial and human capacity.

Sustainability is generally a higher priority in longer-term development projects than emergency relief projects. However, even emergency aid should be based on local capacities and movement towards self-sufficiency of the population.

E.g., *80% of the facilities are still working and managed by the communities one year after the end of the programme.*

### *Relevance*

In terms of relevance, evaluations seek to answer questions such as the following: Is the project aligned with the needs and priorities of the beneficiaries, with the global objective and with ACF's strategy? Was the objective appropriate to the context throughout the project? It is useful to explore this last point for learning lessons which can be applied to future projects.

### *Replicability*

The following questions may be asked: Is the community or local institution able to continue and/or expand services? Is the project transferable to other places and situations or was it so specific to the particular context that it was an isolated experience? The answer to this may be neither positive nor negative, but a full exploration of what can be learned and replicated and what cannot is useful for the design of future projects, both in the same location and different ones.

The evaluation criteria developed above should be used at different levels of the logical framework matrix in order to have a complete overview in the evaluation of the project. Table 2.VII locates the evaluation criteria in the logical framework matrix and describes the type of information required and the timing of collection.

**Table 2.VII: Evaluation indicators and logical framework matrix (adapted from E.U. Project Cycle Management Training Handbook, ITAD, 1999).**

Level of logical framework matrix	Type of information	Timing of collection	Measurement concept
GENERAL OBJECTIVES	Substantive development change specific to the sector Measurement based on trends, possibility of key sectoral indicators <i>Note: the project is only one of many factors influencing change</i>	Project completion & ex-post	SUSTAINABILITY "Continuing the flow of benefits"  IMPACT "Making a difference in the wider environment"  RELEVANCE "Meeting target-group needs"
SPECIFIC OBJECTIVE	Realistic and sustainable change in target-group situation, specific to project intervention	Mid-term & project completion	
	<div style="display: flex; align-items: center; justify-content: center;"> <div style="text-align: center; margin-right: 10px;"> <p>BENEFICIARY RESPONSE</p> </div> <div style="text-align: left;"> <p>Early warning of likelihood of implementation success from opinions of beneficiaries about their access to, use of and degree of satisfaction with services provided by the project</p> </div> </div>	Quarterly / yearly (collected as part of results monitoring)	LEADING INDICATORS Proxies for relevant and sustainable change
RESULTS	Quantitative and qualitative measures of physical progress in service delivery Cost ratios and input-output ratios of performance Comparisons of actual achievements with planned targets	Quarterly / yearly at the end of the project	EFFECTIVENESS "Progress towards objectives – doing the right things"  EFFICIENCY "Efficient implementation – doing things right"
ACTIVITIES	Measures based on activity schedule Comparisons of actual start and completion dates with planned dates Variations from the planned schedule Milestone dates and events	Weekly / monthly	ECONOMY "Ensuring the best relation between cost, quality and time"
COSTS	Measures based on project budget Comparisons of actual against planned spending Analysis of government, donor and beneficiary contributions Cost variance analysis	Weekly / monthly	

II

## Water resources





# Water resources

<b>1</b>	<b>The water cycle</b>	67	4.1	Water within rock	76
<b>2</b>	<b>Rainwater</b>	68	4.1.1	Water storage	77
2.1	The water layer concept	69	4.1.2	Water flow	81
2.2	Rainfall measurement	69	4.2	Main aquifer systems	85
<b>3</b>	<b>Surface water</b>	70	4.2.1	Crystalline bedrock aquifers	86
3.1	The catchment area concept	70	4.2.2	Unconsolidated-rock aquifers	89
3.2	Run-off assessment	70	4.2.3	Aquifers in major sedimentary basins	91
3.3	Flow-rate measurement	71	4.2.4	Highly heterogeneous aquifers	92
3.3.1	Chronometer and container	71	4.3	Aquifer recharge	93
3.3.2	Chronometer and float	72	4.3.1	Piezometric monitoring	94
3.3.3	Weir measurement	72	4.3.2	Simplified water balance	94
3.3.4	Salt-gulp method	73	4.4	Groundwater quality	94
3.3.5	Propeller devices	76	4.4.1	Health aspects	95
<b>4</b>	<b>Groundwater</b>	76	4.4.2	Chemical signatures	96

The water resources used for human consumption are rain, surface water and groundwater. This classification, based on differing characteristics and exploitation methods, is arbitrary, since all these resources are part of the dynamics of the global water cycle.

## 1 The water cycle

The Earth works as a giant distillation plant, where water evaporates continuously and then condenses and falls again to the Earth's surface. This dynamic process is called the 'water cycle', and can be studied at various levels of time and space. Figure 3.1 shows the overall water cycle of the planet.

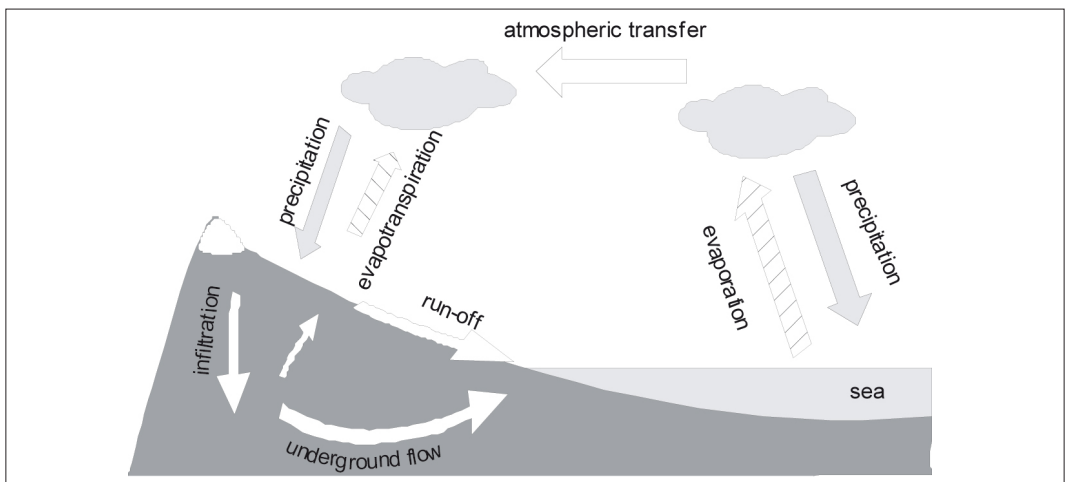


Figure 3.1: The water cycle.

Evaporation occurs mainly at the surface of the oceans, under the influence of solar energy. On the continents, all surface water, as well as shallow groundwater, can be taken up by evaporation. However, the biggest continental contribution is provided by plants in the form of transpiration.

In the atmosphere, water vapour is subject to various winds and transfer movements that feed precipitation.

Part of the continental precipitation is quickly evaporated or transpired, and part rejoins the oceans after having flowed into and fed streams and lakes. A third fraction of precipitation filters into the earth. This water, which becomes groundwater, is not static and continues to be part of the water cycle: it forms groundwater which flows out to feed springs and streams, or flows into the seas (the only exception is fossil sources which are no longer supplied).

The hydrological balance allows the various movements of water to be quantified. This can be written simply as follows:

$$\text{total flow} = \text{precipitation} - \text{evapotranspiration}$$

$$Q_t = P - ETR$$

where  $Q_t$  = total flow;  $P$  = precipitation and  $ETR$  = real evapotranspiration (see Annex 6).

Considering the cycle on the planetary scale, De Marsily (1986) proposes the following annual average values:

- continental precipitations, 720 mm;
- evapotranspiration, 410 mm;
- flow of streams and groundwater to the oceans, 310 mm;
- oceanic precipitation, 1 120 mm;
- oceanic evaporation, 1 250 mm.

These figures nearly balance if it is considered that the oceans cover 70% of the Earth's surface, and the continents cover 30%.

The volumes, flows and retention times in the Earth's large reservoirs are shown in Table 3.I. However, local conditions of relief, climate and geology mean that the cycles vary considerably from one region to another. Note that there is an important difference between these figures and those provided by Castany (1982) and De Marsily (1986); they suggest that groundwater does not exceed 2% of the total volume of reserves, so that the ocean fraction therefore amounts to over 97%.

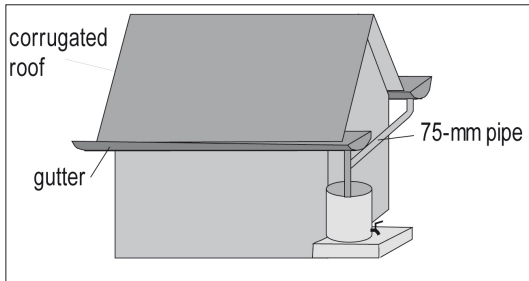
**Table 3.I : The Earth's main water reservoirs (from Caron *et al.* 1995).**

Reservoir	Capacity (%)	Flow (%)	Average retention time
Oceans	80	78	3 172 years
Atmosphere	0.3	7	4 months
Streams and lakes	0.01	7	5.6 years
Groundwater	19.6	7	8 250 years

## 2 Rainwater

The harvesting of rainwater is a common practice in many countries. Generally, two types of catchment systems are used.

Artificial and land surface catchments are used to collect rain. At a domestic level, this surface is generally provided by the roof of the house: gutters collect the rainwater and guide it towards storage vessels (jars, barrels or tanks). In the south of Madagascar and in Haiti, there are collective catchment surfaces made of reinforced concrete slabs laid on the ground, with a slope that allows the water



**Figure 3.2: Harvesting of water from a roof.**

to flow down to underground reservoirs. The bacteriological quality of such water depends on the cleanliness of the collection surface, channels and tank, and on storage and drawing methods

The harvesting of rainwater is also carried out directly: in Cambodia and Myanmar, domestic or collective ponds are dug. Rain fills up those ponds, which can be permanent or temporary, but are generally muddy and biologically contaminated.

For more details regarding rainwater quality, refer to Chapter 4.

## 2.1 The water layer concept

The concept of a 'water layer' is used to express the relationship between rainfall and flow that is produced on a drainage area. A 1-mm water layer corresponds to 1 l/m<sup>2</sup>, so a 100-m<sup>2</sup> roof that collects 10 mm of rain is, in theory, capable of producing 100 x 10 = 1 m<sup>3</sup> of water.

In practice, it is not possible to collect all the rainfall, since part of it is evaporated and part of it is lost (leakage, overflow etc). For domestic or small collective rainwater catchments, Pacey and Cullis, 1986 propose the following harvested-water/rainfall ratios:

- tile: 0.8 to 0.9;
- corrugated metal sheet: 0.7 to 0.9;
- plastic sheets: 0.7 to 0.8;
- concrete: 0.6 to 0.8;
- brick: 0.5 to 0.6.

Therefore, 10 mm of rain falling on a 100-m<sup>2</sup> corrugated sheet roof produces: 100 x 10 x 0.7 = 700 litres of water (Figure 3.2).

In order to design a rainwater-harvesting system, it is advisable to collect the available rainfall data and/or to install a network of rain gauges or rain meters.

## 2.2 Rainfall measurement

The density of the network of rain gauges is selected on the basis of the particular measurement objective and the environmental conditions. For the same climate zone, rainfall can be affected by numerous factors: altitude, exposure of slopes, distance from the sea etc. In a reasonably small and relatively homogenous area, such as certain refugee camps, the installation of one or two rain gauges may be enough. Over a district, the network must be larger in order to incorporate environmental differences.

The measurement sequence must be as long as possible; up to several years for complete accuracy. It is therefore sensible to set up a network of rain gauges as soon as possible, since certain water-supply projects will exist for several years even if a permanent installation is not envisaged at the beginning of the programme. A station that automatically registers rainfall and temperature data can be installed in order to facilitate recording.

Then, it is necessary to give to each rain gauge a geographical area of representation. Several different methods can be used (see Annex 6), but the main ones are:

- the arithmetical mean, which is the least accurate but the easiest to use;
- the Thiessen method (surface weighting), usable in relatively flat areas;
- the isohyetal method, more accurate in the case of broken terrain.

### 3 Surface water

Surface water comes in many forms, and methods of exploitation are very varied.

Part of the rainwater that arrives on the ground runs off. Sometimes this water is intercepted by some man-made structure, especially in areas with a dry climate. For example, in a sahelian area, run-off that concentrates at low points is retained by a dam and used for human and animal needs. These ponds can be temporary or permanent, but they are generally muddy and polluted by faecal matter. They are difficult to protect, but being possibly the only available resource, they are also vital. Storage can be in underground reservoirs, which are called *birkad* in East Africa (Ethiopia, Somalia). Animals do not have a direct access to the reserve, to protect it from contamination, and evaporation is reduced.

Temporary watercourses, sometimes called by their Arabic name, *oued* or *wadi*, are characterised by their usually torrential flow, with a strong erosion capacity upstream and a sedimentation zone downstream. Perennial underground flow frequently accompanies these temporary watercourses, so their exploitation is generally linked to groundwater (see Chapter 5).

Permanent watercourses are used all around the world, since they are perennial and easy to exploit directly. Their quality varies greatly from one situation to another: they are very vulnerable to surface pollution, but have an auto-purification capacity linked to the biological conditions of the aquatic environment. They are usually closely linked to groundwater, and can be exploited indirectly via wells and boreholes in their alluvial deposits.

Lakes are extended areas of water without a direct link to the sea. They are formed in topographic depressions fed by surface-water flow and direct rainfall, or upstream of dams that block surface-water flow. Lakes are therefore considered to have catchment areas in the same way as watercourses. Lakes are widely-used resources of very varied quality. As with any other surface-water source, they are vulnerable to pollution.

For more details on surface-water quality, refer to Chapter 4.

#### 3.1 The catchment area concept

Surface water flows by gravity and so the direction of flow depends on the topography. A catchment area is defined as the group of slopes inclined towards the same watercourse, into which they all contribute water. Catchment areas are divided by watersheds, and are identified on the topographic map by crest-lines. They are usually drained by an out-flowing watercourse, in which case they are known as exoreic basins, but can also be closed (without an outlet) when they are termed endoreic basins.

Exploitation of surface water can take place after assessing its quality (see Chapter 4) and the quantity of water available.

#### 3.2 Run-off assessment

Run-off water is the fraction of rainfall that does not infiltrate and is not returned to the atmosphere by evapotranspiration, and it is therefore necessary to know the various balance terms to calculate it. Nevertheless, a quick assessment can be made as in Table 3.II, which establishes the orders of magnitude of run-off water on natural ground depending on average annual data. Note that these figures do not take into account the slope of the terrain or the intensity of the rainfall. It is therefore necessary to use them with caution, and favour the balance method or, even better, direct observation of the working systems.

**Table 3.II : Run-off assessment.**

Rainfall (mm)	Potential evapotranspiration (mm)	Run-off water (% of the rainfall)	
		fairly impermeable terrain	very permeable terrain
> 1 100	–	16.5	6.5
900 to 1 100	–	13	6.5
500 to 900	< 1 300	10	5
500 to 900	1 300 to 1 800	10	3
400 to 500	1 300 to 1 800	8	1.5
250 to 400	< 1 800	5	0
250 to 400	> 1 800	3	0

A 100 hectare ( $10^6 \text{ m}^2$ ) rainwater catchment made of fairly impermeable compacted soil, in a climate with an average annual rainfall of 750 mm and potential evapotranspiration of 1 000 mm (for calculation of potential evapotranspiration, see Annex 6), can produce about  $10^6 \times 750 \times 10\% = 75\,000 \text{ m}^3$  of run-off water.

### 3.3 Flow-rate measurement

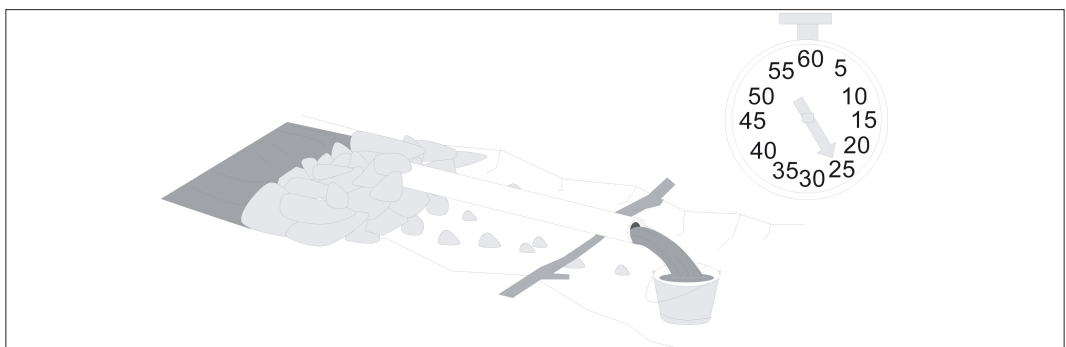
Various methods are used to calculate the flow rates of watercourses. The technique chosen depends on the conditions of flow and the range of flow rates to be measured (Table 3.III).

**Table 3.III : Techniques of flow-rate measurement.**

Direct measurement of the flow rate (recipient and chronometer)	Flow rate < 35 l/s
Measurement of current velocity (float and chronometer) or current meter	Laminar flow
Measurement of the water height (weir)	Laminar flow
Salt-gulp method (salt dilution)	Turbulent flow
	100 l/s < flow rate < 3 m <sup>3</sup> /s

#### 3.3.1 CHRONOMETER AND CONTAINER

For accuracy, the duration of collection must be between 30 and 60 seconds (Figure 3.3). The recipient is calibrated and its capacity is chosen depending on flow rate (Table 3.IV). It is advisable to carry out several measurements and to take an average.



**Figure 3.3: Direct flow measurement.**

**Table 3.IV: Volume of recipient depending on the flow rate.**

Flow rates Q (m <sup>3</sup> /h)	Volume of calibrated recipient (l)
Q < 3.6	20
3.6 < Q < 9	50
7.2 < Q < 18	100
14.4 < Q < 36	200

### 3.3.2 CHRONOMETER AND FLOAT

The flow rate  $Q$  is proportional to the velocity of the water and its flow section. This method is only valid for laminar flow (see Annex 6), and measurement accuracy is poor, since velocity is not constant across the section of the flow.

In practice, the flow section (taken perpendicular to the flow) is measured, and then, using a chronometer, the velocity of passage of a floating body (cork or wood) is measured over a known distance. The float must be launched in the direction of measurement, in the middle of the channel. The velocity obtained is a surface velocity, generally higher than the average flow-section velocity. Then the calculation is corrected with a coefficient,  $B$ , such that:

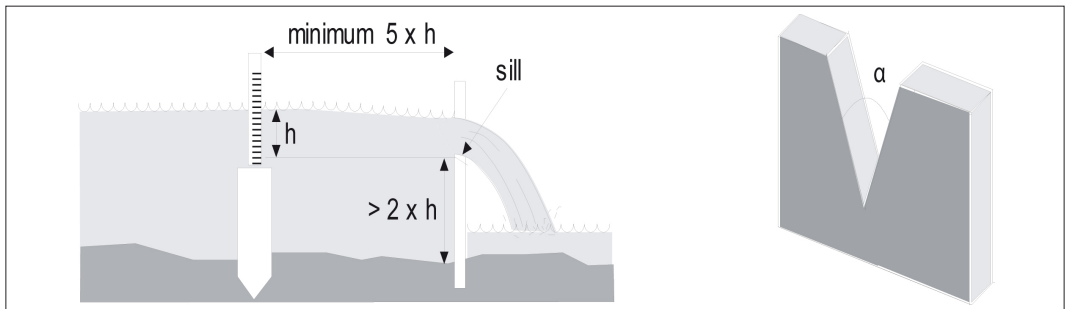
$$Q = B.V.S$$

where  $Q$  is flow rate (m<sup>3</sup>/s),  $V$  is velocity (m/s),  $S$  is normal flow section (m<sup>2</sup>) and  $B$  is a coefficient between 0.6 and 0.8.

### 3.3.3 WEIR MEASUREMENT

A weir is a device that enables flow rate to be calculated from the thickness of a water layer. The principle is to install a board or a metallic plate perpendicular to the flow. The thickness of the water layer measured above the weir is proportional to flow rate, and depends on the characteristics of the device. The flow must be laminar. If this is not the case, it is possible to smooth it by using a relatively high plate. The thickness of the water layer must be measured at a distance from the weir equal to at least 5 times the maximum thickness of the water layer (Figure 3.4).

The shape of the weir is chosen depending on the range of flow rates to be measured: the weir must allow a large variation in water height to be obtained for a small variation of flow rate. The most usual shapes are triangular and rectangular, known as thin-plate weirs (see Box 3.1). Triangular weirs are generally classified depending on their opening angle. Table 3.V gives the application range of the most efficient thin-plate weirs depending on their shape.



**Figure 3.4: Thin-plate weir.**

**Table 3.V: Choice of thin-plate weir.**  
**T: triangular. R: rectangular. L: threshold length.**

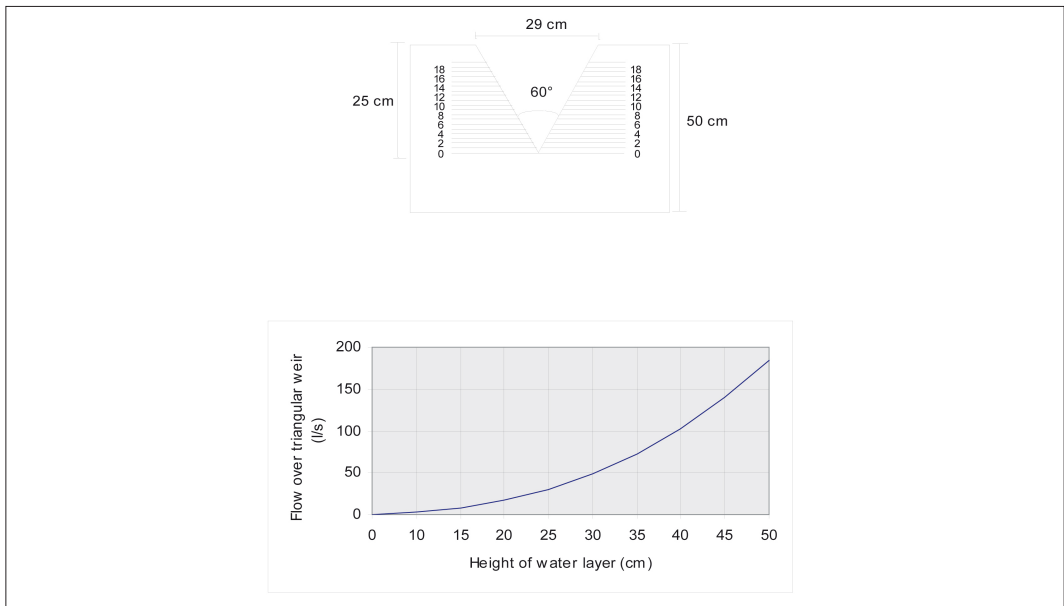
Flow rates to be measured (l/s)		Type of weir
min.	max.	
0.3	40	T - a = 30°
1	100	T - a = 60°
20	150	T - a = 90°
20	200	R - L = 0.3 m
60	500	R - L = 1 m
300	1 500	R - L = 2 m
800	4 000	R - L = 5 m

In the field, the choice of weir must be followed by the construction of a design chart to read the flow rate quickly depending on the height of the water layer (Figure 3.5). Box 3.1 gives the most commonly used formulae.

### 3.3.4 SALT-GULP METHOD

This method is well suited to turbulent flow conditions. It consists of analysing the characteristics of passage of a volume of saline solution introduced into the watercourse (Figure 3.6 and Box 3.2). Two people are needed: the first prepares a solution of salt and then introduces it into the watercourse. Downstream, the second person measures the variation in conductivity induced by the passage of the salt, using a common conductimeter.

The NaCl solution is prepared without exceeding the solubility threshold of 300 g/l at 20° C. The quantity of salt to be used depends on the flow rate of the stream and its base conductivity: the objective is to double the conductivity of the stream in order to be able to measure the passage of the salt cloud. For flow rates of 100 to 3 000 l/s, a quantity of 1 kg of NaCl per 100 l/s allows the base



**Figure 3.5: Design chart for triangular thin-plate weir (Bazin formula, 20-cm blade).**



### Box 3.1

#### Thin-plate weirs.

The weirs are referred to as 'thin-plate' since the thickness of the threshold is less than  $h/2$ , where  $h$  is the thickness of the water layer.

The general flow rate formula for weirs is:

$$Q = \mu \cdot l \cdot h \sqrt{2gh}$$

where  $Q$  is flow rate ( $\text{m}^3/\text{s}$ ),  $\mu$  weir flow-rate coefficient (non-dimensional),  $l$  weir width (m),  $h$  water layer (m) and  $g$  the acceleration due to gravity ( $9.81 \text{ m/s}^2$ ).

#### *Rectangular weir without lateral constriction*

When the width of the weir is the same as that of the supply channel, the weir does not reduce the width of the water layer.

Bazin's formula, which is widely used, defines the coefficient  $\mu$ :

$$\mu = 0.405 + \frac{0.003}{h} \left[ 1 + 0.55 \frac{h^2}{(h + P)^2} \right]$$

where  $P$  is blade height (m). This formula is applicable for values of  $P$  lying between 0.2 and 2 m and  $h$  between 0.1 and 0.6 m.

The SIA formula gives:

$$\mu = 0.410 \left[ 1 + \frac{1}{1000 h + 1.6} \right] \left[ 1 + 0.5 \frac{h^2}{(h + P)^2} \right]$$

It is applicable when  $P$  is higher than  $h$  and  $h$  lies between 0.025 and 0.8 m.

#### *Rectangular weir with lateral constriction*

When the supply channel is wider than the threshold, the SIA gives the following formula:

$$\mu = \left\{ 0.385 + 0.025 \left( \frac{l}{L} \right)^2 + \left[ \frac{2.41 - 2 (l/L)^2}{1000 h + 1.6} \right] \right\} \left[ 1 + 0.5 \left( \frac{l}{L} \right)^4 \left( \frac{h}{h + P} \right)^2 \right]$$

Where  $L$  is the width of the supply channel and  $l$  the width of the weir, both in metres.

This formula is usable when  $P \geq 0.3 \text{ m}$ ;  $l > 0.31 L$ ;  $0.025 L/T \leq h \leq 0.8 \text{ m}$  and  $h \leq P$ .

#### *Triangular weir*

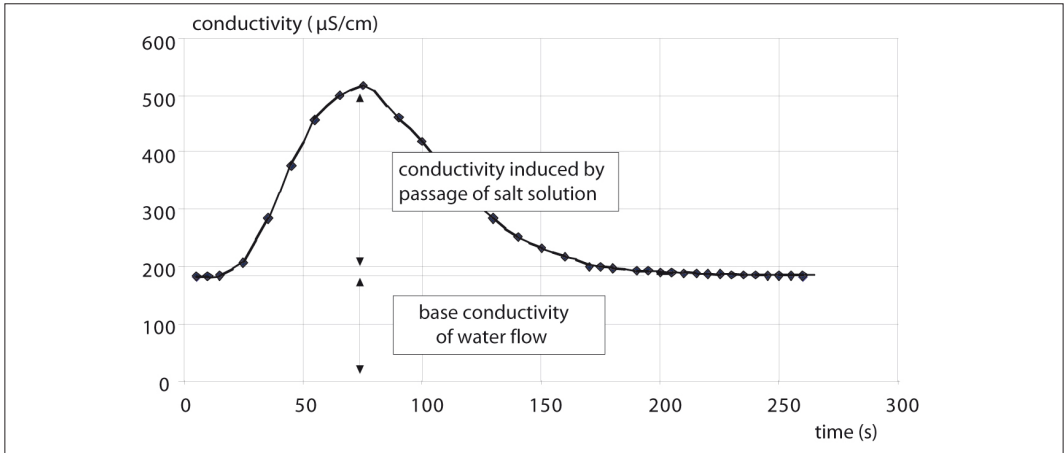
The general formula is:

$$Q = \frac{4}{5} m h^2 \sqrt{2gh} \operatorname{tg} \frac{\alpha}{2}$$

where  $Q$  is flow rate ( $\text{m}^3/\text{s}$ ),  $\mu$  flow-rate coefficient for Bazin's rectangular weir without lateral constriction,  $h$  the thickness of water layer (m) and  $\alpha$  the weir angle.

conductivity of a fairly low mineralised stream (conductivity about  $200 \mu\text{S}/\text{cm}$  at  $25^\circ\text{C}$ ) to be multiplied by about 2.5. The solution is injected quickly, in an area where turbulence facilitates mixing with the stream water.

The distance between the point of injection and the point of measurement is chosen in order to obtain a cloud-passage curve [ $c = f(t)$ ] with a Gaussian distribution (Figure 3.6). An average distance of 80 to 100 m usually gives good results. It is important to choose a section of watercourse where the losses and dead areas are as few as possible so as not to lose or immobilise part of the NaCl solution.



**Figure 3.6: Salt-gulp method.**

### Box 3.2

#### The salt-gulp method.

During the period of time  $dt$ , the conductivity of the water measured during the passage of the cloud of salt is  $\chi$ . This conductivity can be expressed in terms of concentration:

$$c = k\chi$$

where  $c$  is concentration (g/l),  $\chi$  is conductivity ( $\mu\text{S}/\text{cm}$ ) and  $k$  is a conversion factor.

In the same time  $dt$ , the volume of water passing is  $Q \cdot dt$ . The average mass of salt that passes during  $dt$  is therefore:

$$\chi \cdot k \cdot Q \cdot dt$$

Over the whole period of passage of the cloud of salt:

$$M_{\text{NaCl}} = \Sigma k \cdot Q \cdot dt$$

Or:

$$M_{\text{NaCl}} = k \cdot Q \cdot \int \chi \cdot dt$$

The flow rate of the watercourse is therefore given by:

$$Q = \frac{M_{\text{NaCl}}}{k \cdot \int \chi \cdot dt}$$

where  $Q$  is flow rate (l/s),  $M$  is the mass of salt (g),  $k$  is the conversion factor and  $\int \chi \cdot dt$  is the integral over the whole passage period of the cloud [( $\mu\text{S}/\text{cm}$ ).s].

#### Conversion factor $k$

The factor  $k$  varies with the temperature and mineralisation of the water. For water at  $25^\circ\text{C}$  (automatic correction of the conductimeter) and slightly mineralised ( $\chi_{\text{untreated water}} \approx 200 \mu\text{S}/\text{cm}$ ),  $k = 5.48 \times 10^{-4}$ .

#### Average concentration

The formula  $Q = M_{\text{NaCl}} / k \cdot \int \chi \cdot dt$  is not very different from  $Q = M_{\text{NaCl}} / \bar{c} \cdot t$  when the curve  $\chi = f(t)$  is Gaussian, where  $\bar{c}$  is the average concentration of NaCl over the period  $t$  ( $\bar{c} = k \cdot \bar{\chi}$ ) and  $t$  is the time of passage of the cloud of salt.

It is advisable to draw the curve  $\chi = f(t)$  on graph paper and to integrate it (small-squares method) in order to obtain a sufficient degree of accuracy. Calculation by average conductivity is not as useful as when the curve is Gaussian.

The flow rate of the watercourse is given by:

$$Q = \frac{M_{\text{NaCl}}}{k \cdot \bar{\chi} \cdot t}$$

where  $Q$  is the flow rate of the watercourse (l/s),  $M$  is the mass of salt used to make the solution (g),  $\bar{\chi}$  is the average conductivity induced by NaCl over the period  $t$  ( $\mu\text{S}/\text{cm}$ ),  $k$  is the conductivity/concentration conversion factor ( $k \approx 5.48 \cdot 10^{-4}$ ) and  $t$  is the time of passage of the cloud of salt (s).

### 3.3.5 PROPELLER DEVICES

Propeller devices, often called current meters, consist of a shaft with a propeller connected to the end. The propeller is free to rotate, and the speed of rotation is proportional to the stream velocity if the flow is laminar.

The number of rotations of the propeller produced by the flow, on a normal section of the stream at various depths and distances from the bank, is recorded. After conversion of the number of rotations into velocity, it is possible to calculate the flow rate passing through the measured section when the section area is known.

## 4 Groundwater

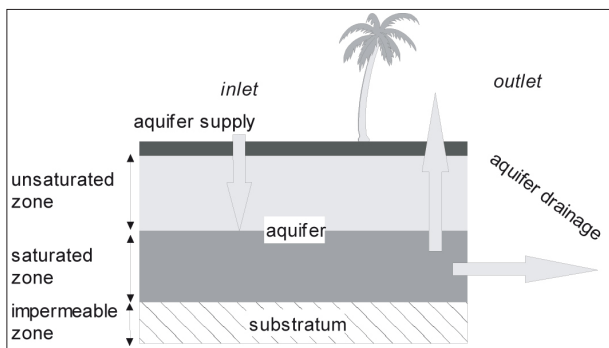
According to Castany (1982), nearly 60% of the drinking water reserves of the planet are stored in the form of ice or snow, less than 0.5% in continental surface water and 40% in the form of groundwater. The use of this resource is therefore a vital matter for many populations.

### 4.1 Water within rock

Rocks capable of containing water and allowing it to flow easily are called aquifers. An aquifer is not necessarily a homogenous geological group: it can be composed of different rocks or strata. An aquifer has an area saturated with water, and sometimes a non-saturated area. It is spatially restricted by an impermeable rock at its base (the wall or substratum), sometimes by an impermeable rock above it (the roof), and by lateral restrictions.

The groundwater is all the water contained in the aquifer, generally supplied by useful precipitation (the fraction of precipitation that infiltrates and feeds the aquifer) and the infiltration of surface water (streams and lakes).

Aquifers are not static: part of the water leaves the aquifer in the form of springs, feeding surface water (streams, lakes, seas), by pumping, or by direct evaporation (Figure 3.7).



**Figure 3.7: Storage and flow in an unconfined aquifer.**

To describe an aquifer, a group of parameters related to its nature, geometry and functions (water storage and outflow capacity) are used (Box 3.3).

**Box 3.3**

**Representative sample volume.**

A porous environment can be physically defined by three characteristics:

- *continuity/discontinuity*: an environment is called continuous if its voids are interconnected in the direction of the flow;
- *homogeneity/heterogeneity*: an environment is homogenous if its characteristics are constant in the direction of the flow;
- *isotropy/anisotropy*: an environment is called isotropic when its physical characteristics are constant in the three dimensions.

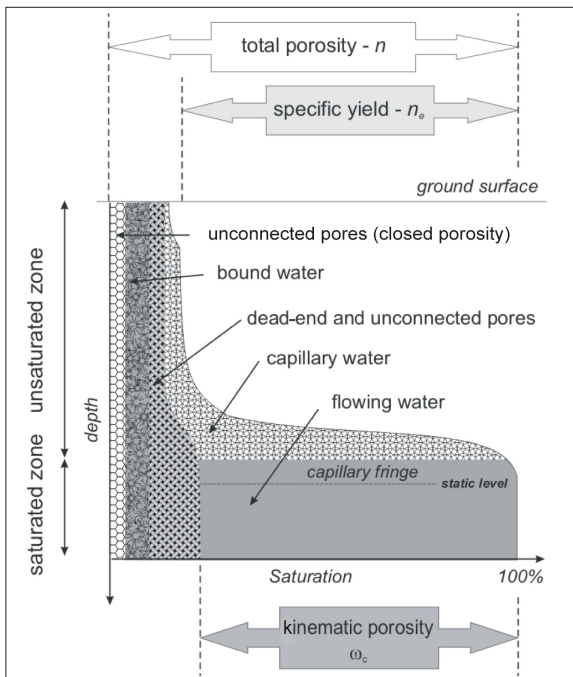
The concepts of porosity and permeability, defined in the following sections, are linked to the scale of observation. In fact, a fissured rock is considered non-homogenous when observed at a centimetre scale, but it can be considered homogenous if observed at a kilometre scale.

The concept of representative sample volume (RSV) describes the characteristics of an aquifer: for example, a RSV at the  $\text{cm}^3$  scale is used for sands or gravels, and at the  $\text{m}^3$  or  $\text{km}^3$  scale for fissured rock.

Even though this concept of RSV is often used, it presents considerable problems. Certain authors therefore define the concept of random function and study the environment as the development of random phenomena (De Marsily 1986).

**4.1.1 WATER STORAGE**

The quantity of water stored in an aquifer at a given instant depends on the volume of the reservoir and its capacity to bear water (Figure 3.8).



**Figure 3.8: Groundwater type and storativity.**

### *Total porosity*

Most rocks naturally contain a certain percentage of voids that can be occupied by water. Total porosity ( $n$ ) is the capacity of an aquifer to store water so that (Figure 3.8):

$$n = \frac{\text{void volume}}{\text{total volume}}$$

Generally, total porosity is expressed as a percentage.

The voids are not necessarily interconnected and the water is not always free to flow within the rock: total porosity is a necessary condition for water flow, but it is not the only one.

Generally, two types of porosity can be distinguished, depending on the geological nature of the aquifer. Microporosity (also primary or interstitial porosity) refers to the intrinsic porosity of the rocks, while macroporosity (fracture or secondary porosity) refers to the porosity induced by fissures, fractures or karstic developments of consolidated rocks. Certain aquifers, such as some sandstones or carbonated rocks, have both interstitial and fracture porosity simultaneously.

The total porosity of unconsolidated rock (sand, gravel) is controlled by its granularity, which is generally studied by screening a volume of rock, and is expressed in a normalised particle-size curve (Box 3.4). The more uneven the granularity, the lower the porosity. In the case of even granularity, grain size has no effect on total porosity; it is the arrangement of the grains which controls total porosity, which theoretically varies between 26 and 48%.

### *Relationship between water and rocks*

Experience shows that part of the water contained in the aquifer cannot easily be extracted. A distinction can therefore be drawn between water bound to the rock by forces of molecular attraction and free water, which can move under the influence of gravity or pressure gradients.

According to De Marsily (1986), bound water corresponds to a layer of water molecules about 0.1  $\mu\text{m}$  thick adsorbed onto the surface of the rock grains, and to a layer of water about 0.4  $\mu\text{m}$  thick, known as a film, which is also subject to a measurable attractive force.

The bound fraction of the water is larger when the specific area ( $S_p$ ) of the reservoir is greater:

$$S_p = \frac{\text{grain surface}}{\text{total volume}}$$

For example, medium sand presents a specific area of 10-50  $\text{cm}^2/\text{cm}^3$ , and clay presents 500 to 800  $\text{cm}^2/\text{cm}^3$ . This explains the fact that certain clays contain a great amount of water, but that water is bound and therefore cannot be moved by pumping; these clays are therefore regarded as impermeable.

For unconsolidated rock, the specific area is governed by the granularity. The diameter  $d_{10}$  and the uniformity coefficient are generally used to characterise the sample (Box 3.4).

The presence of capillary water suspended by capillary forces just above the saturated area is also of note. This 'capillary fringe' is well known by well diggers, as it is the first sign of water.

### *Kinematic porosity*

In the saturated zone, free water consists of the water free to flow plus the water in the unconnected and dead-end pores (Figure 3.8). Kinematic porosity  $\omega_c$  (often called effective porosity) represents the free-flowing water in the saturated zone; it is often used in flow and transport modelling, and is defined as the ratio between the Darcian velocity and the true linear velocity (see following sections).

Note that unconnected and dead-end pores can play an important role in karstic and hard-rock contexts, but they are usually negligible in unconsolidated sediments.

### *Storativity*

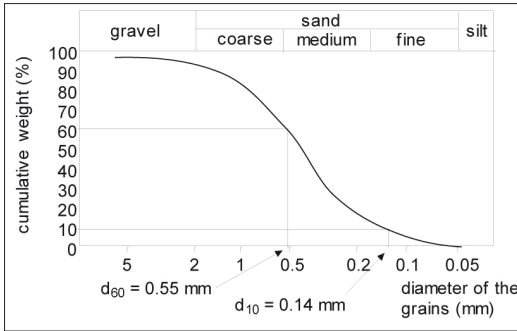
The groundwater fraction which is of interest for abstraction is quantified by the storativity.

### Box 3.4

#### Particle-size analysis.

Particle-size analysis facilitates:

- study of the characteristics of the grains and voids of a porous environment;
- classification of the rocks according to a nomenclature;
- calculation of the characteristic particle-size parameters;
- accurate definition of the borehole equipment plan.



Particle-size analysis is based on a sample of the formation being studied. By successive screening, the various sizes of particle are separated and then weighed. The results are then represented in a standard curve (Figure 1), plotting the particle size in mm logarithmically on the horizontal axis and the percentage cumulative weight of successive screenings on the vertical axis.

**Figure 1: Particle-size curve.**

#### Rock classification

There are various classifications of unconsolidated rocks depending on their particle size, such as this one, proposed by Castany (1982):

Designation	Diameter of the particles (mm)
Pebbles, stones, blocks	> 16
Gravel	16 to 2
Coarse sand	2 to 0.5
Medium sand	0.5 to 0.25
Fine sand	0.25 to 0.06
Silt	0.06 to 0.002
Clay	< 0.002

#### Characteristic parameters

The majority of natural samples are a mixture of different particle sizes. The particle-size curve defines the whole group.

The uniformity coefficient,  $CU = d_{60}/d_{10}$ , allows the slope of curve to be calculated. If the  $CU < 2$ , the particle-size distribution (granulometry) is referred to as uniform, otherwise it is termed stepped.

The characteristic diameter,  $d_{10}$  is a conventional diameter, usually used to represent a sample.

In a confined aquifer (see Section 4.2), water release is related to the water-expansion and aquifer-compaction effect attributed to aquifer pressure changes due to pumping. This elastic water release is quantified by the storage coefficient as (De Marlisy 1986):

$$S \approx \left[ \rho \cdot g \cdot n \cdot \left( \beta_1 \cdot \frac{\alpha}{n} \right) \right] \cdot e$$

where  $\rho$  is the water mass/volume ratio,  $g$  is gravity acceleration,  $\beta_1$  is the water compressibility,  $\alpha$  is the aquifer compressibility,  $n$  is the total porosity and  $e$  is the saturated thickness.

When an unconfined aquifer is desaturated by well pumping, the quantity of extracted water is determined both by elastic water-release phenomena and by gravity-water phenomena. The storage coefficient is then:

$$S \approx \left\{ \left[ \rho \cdot g \cdot n \cdot \left( \beta_1 \cdot \frac{\alpha}{n} \right) \right] \cdot e \right\} + n_e$$

where the term  $[\rho \cdot g \cdot n \cdot (\beta_1 \cdot \alpha/n)]$  represents the elastic phenomena and  $n_e$  the specific yield parameter, which is:

$$n_e = \frac{\text{gravitational water volume}}{\text{total volume}}$$

Because the value of the storage coefficient is several orders of magnitude smaller than the value of specific yield, the storativity of an unconfined aquifer is usually taken to be equal to the specific yield. It means that the water release (or storage) is due to the gravitational drainage of the aquifer because of the falling water level while pumping. This is why specific storage is commonly called drainage porosity, gravity porosity or effective porosity.

Note that a confined aquifer that is desaturated by pumping (if the dynamic level falls below the bottom of the confining layer) becomes partially unconfined. The specific drainage ( $S_d$ ) is the parameter that quantifies the volume of water that could potentially be released by a confined aquifer due to gravity (Lubczynski & Roy 2003).

In a unconfined aquifer, the phenomenon of seepage takes place when there is a drop in the water level (particularly due to pumping). In a confined aquifer, the release of the water is not caused by gravity, but by decompression of the water and the reservoir generated by a reduction in head (see Annex 12). As the compressibility of both aquifer and water is very small, we no longer refer to effective porosity but to a storage coefficient ( $S$ ) defined as the volume of water released by a vertical prism of aquifer material of unit section as a result of a unit change in head; this factor is non-dimensional.

#### Assessment of porosity

Porosity can be measured by tests carried out in the laboratory. However, in ACF programmes, it is more useful to calculate the porosity by an *in-situ* method.

The most reliable method of calculating the storage coefficient ( $S$ ) and/or the specific yield ( $S_y$ ) is to carry out test pumping (see Chapter 6). Geophysics can also be used in favourable contexts to estimate the porosity of the medium (see Chapter 5). Electrical prospecting allows a relationship to be established between the resistivity of a rock and its porosity, using Archie's formula in unconsolidated sediments without clay (which is not common); MRS can estimate the storativity if calibrated with pumping-test data.

Table 3.VI gives some values of total porosity and specific yield for various reservoirs.

**Table 3.VI: Total and specific yield, diameter  $d_{10}$  (from Castany 1982).**

Reservoir	$d_{10}$ (mm)	$n$ (%)	$n_e$ (%)
Medium gravel	2.5	45	40
Coarse sand	0.25	38	34
Medium sand	0.125	40	30
Fine sand	0.09	40	28
Silty sand	0.005	32	5
Silt	0.003	36	3
Clay	0.0002	47	–

#### 4.1.2 WATER FLOW

In addition to its storage capacity, an aquifer is capable of conducting water. In the reservoir, the flow is determined by three groups of parameters: permeability and transmissivity; hydraulic head and gradient; speed rate and flow rate.

##### *Permeability and transmissivity*

Permeability is the capacity of a reservoir to allow water to pass through it under the influence of a hydraulic gradient. It is classified by intrinsic permeability  $k$ , expressed in  $m^2$  or in a unit called the Darcy which takes into account the characteristics of the reservoir, and the hydraulic conductivity  $K$ , expressed in  $m/s$ , and which takes into consideration the characteristics of both the reservoir and the fluid, as follows:

$$K = \frac{g}{\nu} \cdot \frac{d^2}{a} = \frac{g}{\nu} \cdot k$$

where  $K$  is the hydraulic conductivity, which depends on both the liquid, by  $(g/\nu)$  and the porous environment, by  $(d^2/a)$ ;  $k$  is the intrinsic permeability, which depends only on the porous environment, by  $(d^2/a)$ ;  $g$  is the acceleration due to gravity;  $\nu$  is the kinematic viscosity of the fluid,  $d^2$  is a dimension that characterises the environment, and  $a$  is a non-dimensional constant.

In hydrogeology, it is usually assumed that the characteristics of the water are constant (dynamic viscosity and specific gravity), so it is possible to work directly with hydraulic conductivity. Note that the main parameter that influences hydraulic conductivity in hydrogeology is the temperature of the water (through its viscosity); this has a great influence because a reduction of 40% in hydraulic conductivity is caused by a change of the water temperature from 25 to 5°C.

The coefficient  $K$  can be calculated by *in-situ* or laboratory methods. *In-situ* methods are carried out at a borehole:

- pumping test (see Chapter 6): this is recommended, as it takes into account the heterogeneity of the terrain;
- Lefranc tests for continuous environments and Lugeon test for fractured environments: these are methods that allow calculation of local permeability that applies only within the surroundings of the well;
- tests used in sanitation (see Chapter 13).

Laboratory methods involve the use of:

- a constant-level ( $K < 10^{-4}$  m/s) or variable-level permeability meter ( $K > 10^{-4}$  m/s), (see Darcy's experiment);
- Hazen's formula, which defines permeability for a granulometrically continuous environment as:  $K_{\text{Hazen}} = (0.7 + 0.03t_F) \cdot d_{10}^2$  where  $t_F$  is water temperature (°F) and  $d_{10}$  the grain diameter (cm) such that 10% of the elements are smaller.

Table 3.VII gives orders of magnitudes of permeability. The limit of impermeability is generally based on the coefficient  $K = 10^{-9}$  m/s.

Finally, transmissivity is a parameter that expresses the productivity of an aquifer, so that:

$$T = K \cdot e$$

where  $T$  is transmissivity ( $m^2/s$ ),  $K$  is hydraulic conductivity ( $m/s$ ) and  $e$  is the thickness of the saturated aquifer (m).

##### *Hydraulic head*

In a porous environment, energy is generally expressed as 'head', or height, so that the unit is a length (see Annex 12). The hydraulic head is expressed in relation to sea level, whereas the piezometric head is expressed in relation to an origin that must be defined: for example, piezometric level may be measured in relation to the ground, the top of borehole casing etc.



**Table 3.VII : Orders of magnitude of hydraulic conductivity K (m/s) (from Brassington 1998).**

10 <sup>-10</sup> impermeable	10 <sup>-9</sup>	10 <sup>-8</sup>	10 <sup>-7</sup>	10 <sup>-6</sup> semi-permeable	10 <sup>-5</sup>	10 <sup>-4</sup>	10 <sup>-3</sup>	10 <sup>-2</sup>	10 <sup>-1</sup> permeable
<i>Unconsolidated rocks</i>									
solid clay		silt, clay, mixture silt/clay		fine sand		clean sand, mixture sand/gravel		clean gravel	
<i>Consolidated rocks</i>									
granites, gneiss, compact basalts		sandstone, compact limestone, argillaceous schists		sandstone, rocks fractured				karst	

*Flow and velocity of water*

In 1856, Henri Darcy experimentally established the formula that bears his name (Figure 3.9). It defines the rate of flow passing through a porous environment, so that:

$$Q = K \cdot A \frac{\Delta h}{L}$$

where Q is the flow rate through a porous environment (m<sup>3</sup>/s), K is the hydraulic conductivity (m/s), A is the section of the porous formation normal to the flow (m<sup>2</sup>), L is the length of the sandy formation transited by the fluid (m), and Δh is the difference between the hydraulic heads upstream and downstream of the length (m) under consideration.

The hydraulic gradient is defined as  $i = \Delta h/L$ , a non-dimensional factor, and produces the simplified Darcy's equation:

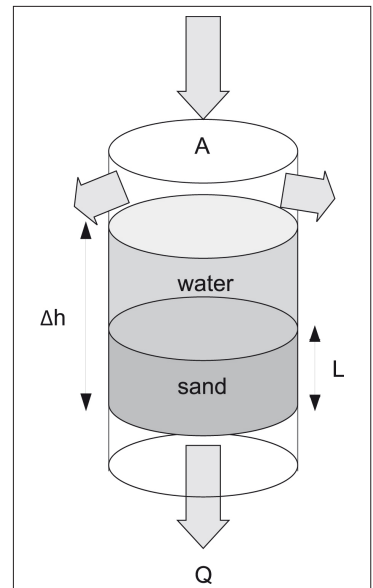
$$Q = K \cdot A \cdot i$$

Darcy's equation is valid under the following conditions:

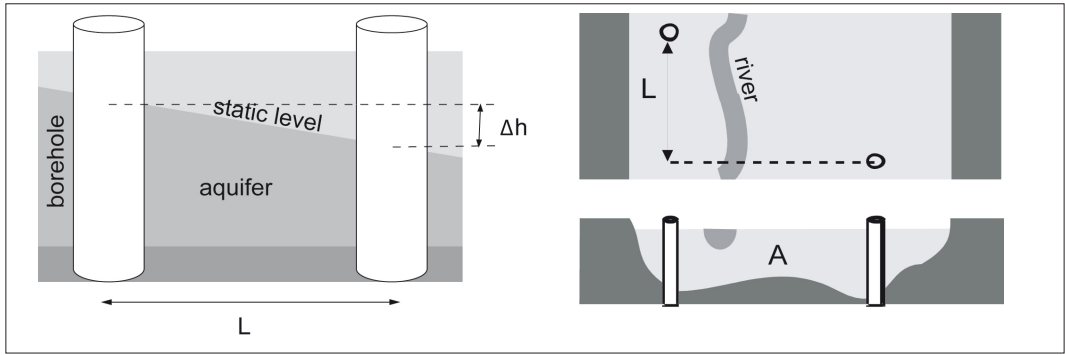
- continuous, homogenous and isotropic environment (Box 3.3),
- laminar flow,
- permanent flow (see Annex 6).

In practice, underground flow often meets these conditions, except in a highly heterogeneous medium such as a karstic environment or in the immediate surroundings of a pumped well. The transition from laminar to turbulent flow can be estimated from the hydraulic gradient by an empirical formula. Thus, De Marsily (1986) defines the gradient limit for Darcy's equation validity so that  $i = 1/15 (K)^{1/2}$ .

If Darcy's equation is now expressed per unit area, the filtration rate, or unitary flow rate, is obtained as  $q = K \cdot i$  (m/s). The rate of flow passing through an aquifer can therefore be calculated using Darcy's equation. In fact, knowing K, it is simple to calculate the unit flow rate between two points from the static levels measured in two wells. Furthermore, if the geometry of the aquifer can be assessed (from boreholes, geophysics or geological characteristics), the flow rate passing through the reservoir can be determined (Figure 3.10).



**Figure 3.9: Darcy's experiment.**



**Figure 3.10: Application of Darcy's experiment.**

Note that this filtration velocity is notional, since it assumes that the water uses the whole section of the aquifer to circulate. Part of this section is in fact occupied by the materials of the aquifer itself. If we assume that the water does not circulate through the whole section, but only through the space that can be estimated from specific yield, the effective velocity is obtained as:

$$V_e = \frac{q}{S_y}$$

These hydrodynamic velocities provide orders of magnitude and help to compare the various environments, but they remain theoretical. To obtain more real velocities, it is necessary to resort to hydrokinematics, in which tracing methods are used to reveal the realities of the flow.

### *Piezometry*

The map of the piezometric surface is established using measurements carried out in a group of wells in an even context. It is a basic document that imparts an understanding of the dynamics of an aquifer. Such a map is valid only at a given moment, and is meaningful only when it is based on piezometric lines from measurements carried out in the wells, boreholes or springs corresponding to a single aquifer.

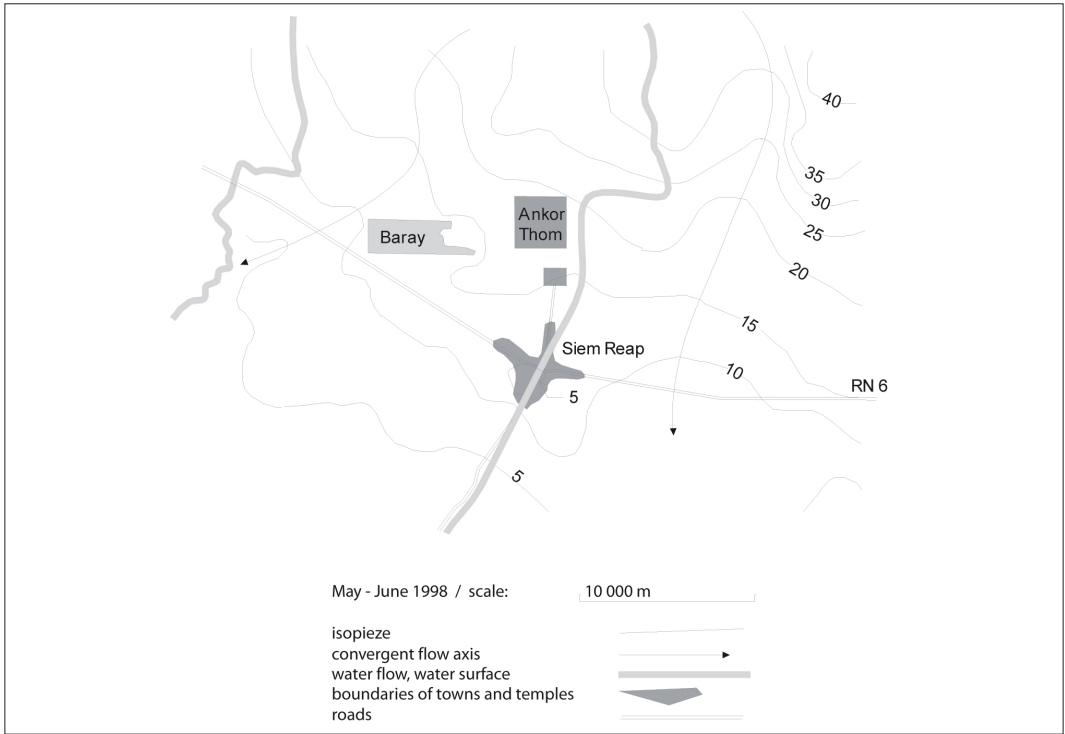
In humanitarian programmes, piezometric levels can be obtained by measuring, over a short period of time, the levels in wells at rest. The various measurement points must be located in space: GPS co-ordinates for x and y, and levels or topographic mapping for z. These values enable the piezometric map to be drawn (Figure 3.11): manual interpolation is the most reliable (see Annex 6).

Piezometric maps are interpreted as follows:

- the curvature of lines of the same level (isopiezometric lines or groundwater contours) differentiates the divergent and convergent flows. A divergent flow can indicate a line of separation of the groundwater or a recharge zone, whereas a convergent flow underlines a preferential flow axis. Rectilinear flows are rare, but are characteristic of a flat, homogenous aquifer, with a constant thickness;

- the spacing of the isopiezometric lines determines whether or not the flow is even. A narrowing of the lines means an increase in hydraulic gradient (according to Darcy,  $Q = KAi$ , so if  $i$  increases and the flow rate is constant, then  $A$  decreases – rise of the substratum or reduction in size, or  $K$  decreases – change of facies). On the contrary, if the isopiezometric lines separate and  $Q$  is constant, then  $A$  or  $K$  increase.

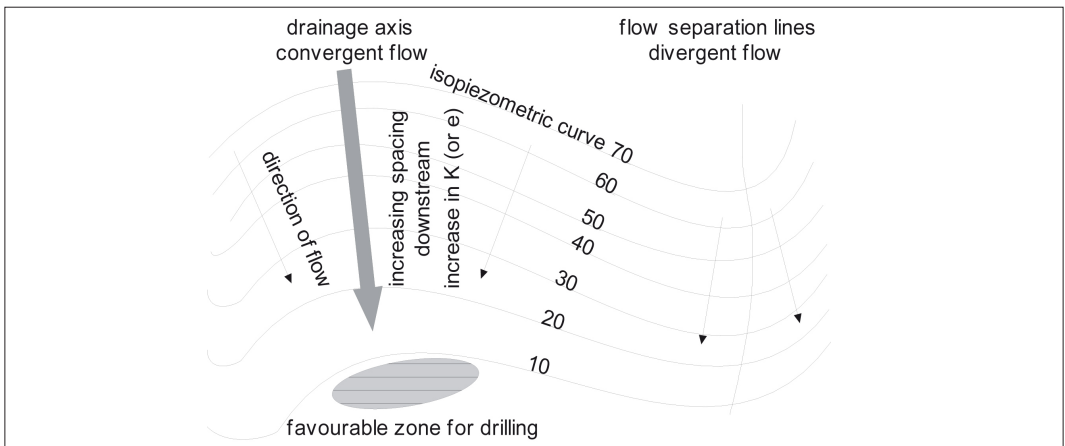
It is thus possible to calculate the variation of certain parameters of the aquifer on the basis of the study of the piezometric map. Indeed, according to Castany (1982), the lateral transmissivity variations (thus of  $K$  or  $e$ ) are more frequent than the variations of flow rate in the aquifer (a radical



**Figure 3.11: Piezometric map (Prasat Bakong, Siem Reap district, Cambodia, ACF, June 1998).**

change of flow rate can be identified by a particular supply: stream, lake etc.). The result is that isopiezometric lines with a curvature indicating a convergent flow and with increasing downstream spacing correspond to a drainage axis with a permeability or thickness increasing downstream. This is a favourable location for a well or borehole (Figure 3.12).

Monthly piezometric monitoring of newly constructed boreholes and wells also allows the impact of extraction on the aquifer to be measured, and seasonal variations of the piezometric level to be estimated (see Chapter 6).



**Figure 3.12: Piezometry.**

## 4.2 Main aquifer systems

Table 3.VIII lists the principal hydrodynamic parameters that characterise aquifers. Aquifers are also defined by their geometry and by their limits. The base limit consists of an impermeable layer (in theory,  $K < 10^{-9}$  m/s), called the wall or substratum. As for the upper limit:

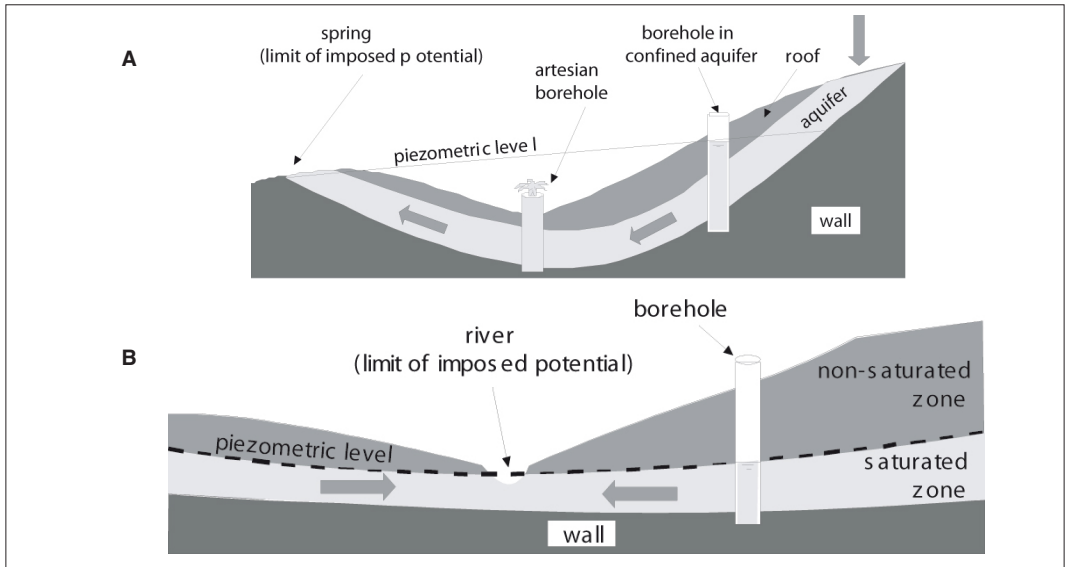
- if the aquifer is covered by impermeable material (roof) or barely permeable material (sometimes called an aquiclude), and the piezometric head is higher than the elevation of the roof, the aquifer is referred to as ‘confined’. A borehole made in a confined aquifer therefore presents a piezometric level higher than that of the aquifer’s roof. If the piezometric level is higher than the topographic level then the borehole becomes artesian (Figure 3.13A);

- an aquifer of which the upper section is occupied by a non-saturated area is called a ‘unconfined aquifer’. In this case, the static level of a borehole coincides with the water level in the aquifer (Figure 3.13B). A remarkable difference in the behaviour of these aquifers occurs in the course of a pumping process. The productivity of a unconfined aquifer decreases because the transmissivity ( $T = K \times e$ ) drops as  $e$  reduces. The transmissivity of a confined aquifer does not change during pumping, as long as the piezometric level remains higher than the roof. Aquifers that change from a free to a confined state, depending on topography, can sometimes occur.

The lateral limits of an aquifer can be geological (fault, lateral change of facies etc.) and/or hydrodynamic and thus variable in time and space. The limits in flow match incoming or outgoing flow rates (supply by a lake, drainage by a spring line etc.); the potential limits act on the aquifer by imposing a head level (level of a water surface, stream etc.). In some cases, these limits, usually called boundaries, will be mixed.

**Table 3.VIII: Principal hydrodynamic parameters of aquifers.**

	Parameter	Symbol	Usual unit	Notes	
Storage	Total porosity	$n$	%	$n = V_{\text{void}}/V_{\text{total}}$	
	Kinematic porosity (or effective porosity)	$\omega_c$	%	$\omega_c = \text{hydrokinetic speed/Darcy flow rate}$	
	Specific yield (or drainage porosity)	$S_y$ ou $n_e$	%	$S_y = V_{\text{water grav}} / V_{\text{total}}$	
	Characteristic diameter	$d_{10}$	mm	10% of the smallest sample	
	Specific surface	$S_s$	$\text{cm}^2/\text{cm}^3$	$S_s = S_{\text{grain}}/V_{\text{total}}$	
	Storage coefficient	$S$	non dimensional	measure <i>in situ</i> (see Chapter 6)	
	Thickness	$e$	m		
	Reserve	$W$	$\text{m}^3$	$W = S \times e$	
	Flow	Hydraulic conductivity	$K$	m/s	measure <i>in situ</i> (see Chapter 6)
		Intrinsic permeability	$k$	$\text{m}^2$ or Darcy (D)	for water at 20°C : $1 \text{ D} = 0.98 \cdot 10^{-12} \text{ m}^2$
Transmissivity		$T$	$\text{m}^2/\text{s}$	$k \text{ (D)} = 0.966 \cdot 10^{-5} K$ $T = K \cdot e$	
Hydraulic head		$H$	m of water column		
Static water level		SWL	m	measured by reference to a datum	
Hydraulic gradient		$i$	non-dimensional	$i = (H_2 - H_1)/L$	
Unitary flow rate or filtration velocity		$q$	m/s	$q = K \cdot i$	
Darcy flow rate		$Q$	$\text{m}^3/\text{s}$	$Q = K \cdot A \cdot i$	
Effective velocity		$V_e$	m/s	$V_e = q/S_y$	



**Figure 3.13: Aquifers.**

**A: confined. B: unconfined.**

#### 4.2.1 CRYSTALLINE BEDROCK AQUIFERS

Bedrock geological formations are very widespread and have been subject to major exploitation for about twenty years. These plutonic and metamorphic rocks are characterised by their compact nature, and by their very low porosity and permeability. Nevertheless, permeable horizons have sometimes been able to develop due to processes of physical-chemical weathering, and some phenomena of tectonic origin have allowed these rocks to acquire a secondary permeability that favours the formation of aquifers. Certain old sedimentary rocks resemble igneous and metamorphic rocks in their hydrogeological behaviour, and are therefore usually regarded as bedrocks also.

##### *Geological formations*

Three types of formation, each with its own characteristics, can be distinguished: granites, gneiss and migmatites; schists and greenstones; and quartzite sandstones. For simplicity, the terms granites, schists and sandstones will be used in this section, always bearing in mind the idea that these terms represent groups of rocks with usually similar hydrogeological behaviour.

Granites are compact, relatively inelastic rocks. Usually fractured, they present a network of fissures and open or closed fractures depending on orientation. Beyond about 50-70 m in depth, it is generally assumed that the majority of the fissures are closed due to the weight of the ground. Weathering phenomena that affect granites are essentially the result of the actions of water and temperature. Considerable variations in the nature and thickness of these weathered rocks are observed, depending on climatic areas and drainage conditions. Granites weather to a more or less argillaceous sand, with a thickness that can reach several tens of metres. At the base of these residues of weathering and at the contact layer with the solid rock, a coarse, sandy gravel is usually present (Figure 3.14).

Schists are deformed more easily than granites and thus do not always contain such a well-developed fracture network (Figure 3.15). They can nevertheless exhibit some fracturing linked to their structure. The weathering of these rocks can be very deep, but it is usually very argillaceous.

Quartzite sandstones are generally very consolidated and may have suffered significant fracturing. Usually less weathered than the other rocks, they sometimes have intercalations of a different nature (carbonates, pelites etc.) which can provide drainage.

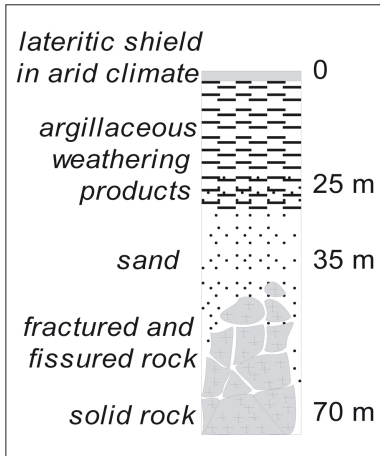


Figure 3.14: Weathering profile of granites.

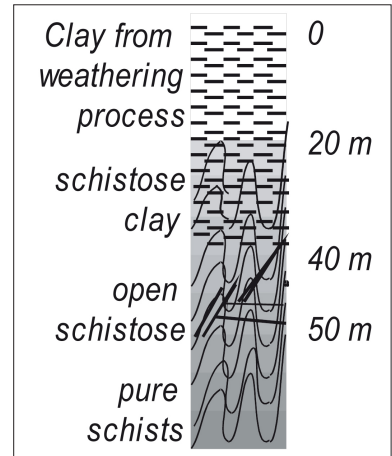


Figure 3.15: Weathering profile of schists.

### Aquifers

There are three basic types of reservoir:

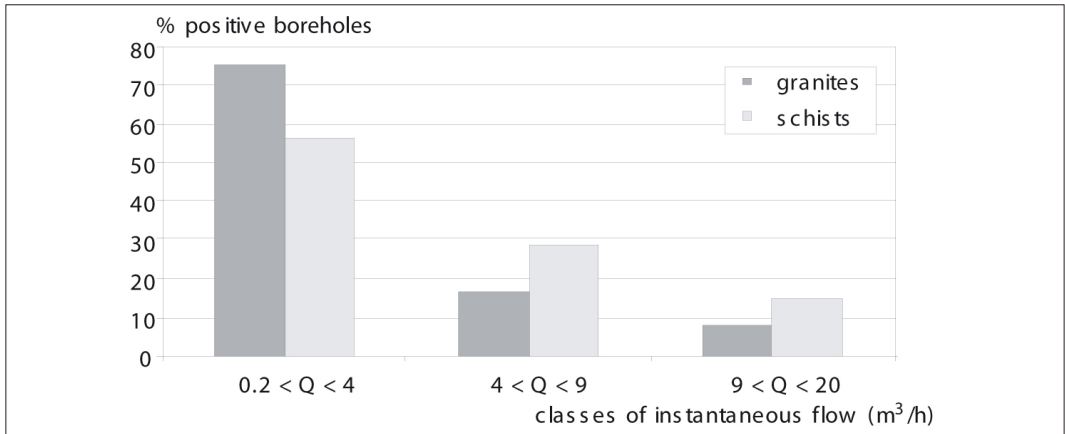
- *reservoirs composed of weathering products*, such as sandy-argillaceous gravels, of considerable extent in the areas of African basement zones. Their average thickness (10-20 m in granite-gneiss and 15-40 m in West African schists) is greater in equatorial zones and decreases towards the tropics;
- *fissure reservoirs situated just beneath the solid rock*. These are partially-weathered areas, made up of numerous fissures and joints, generally filled with weathering products. These reservoirs can extend over several tens of metres;
- *networks of faults or major fractures*, which can be the basis of groundwater movement.

Numerous studies carried out in West Africa (Lachassagne *et al.*, 2001, Wright & Burgees, 1992, University of Avignon 1990) have shown that these various reservoirs generally constitute a single aquifer, the storage function of which is ensured by the weathering products, and the flow function by the fissured or fractured area. The static level is generally situated in the weathering products. This group may in turn be drained by major fractures, an essentially conductive role. On the other hand, isolated aquifers of weathering products, fissures or faults, can also be found locally.

A statistical summary of the data from West Africa shows that the rate of success and productivity of boreholes increases with the thickness of weathering; and an empirical relationship between specific flow rate and the weathering thickness  $W_1$  can sometimes be found in a particular region. There is however a critical thickness threshold at about 35 m, beyond which productivity tends to decrease.

Much the same is true of the fissured and weathered areas: from about 30 m thickness, productivity does not seem to increase; beyond 50 m it becomes random. In all probability, this thickness is greater in the case of sandstone massifs. Figure 3.16 shows the types of instantaneous flow rates (slightly overvalued) obtained depending on the type of aquifer, in West African rural boreholes.

The productivity and the rate of success of a borehole depends equally on the quality of the weathering products and on the fissures: clay content, density and openness or blockage of fissures etc. The University of Avignon (1990) suggests transmissivities of  $10^{-4}$  to  $10^{-2}$  m<sup>2</sup>/s and storage coefficients of  $2 \times 10^{-5}$  to  $5 \times 10^{-5}$  obtained in granite-gneiss, from pumping tests carried out in Ghana and Bénin. Wright (1992) gives an average transmissivity obtained by pumping test, in the granites and gneiss of Zimbabwe, of  $5 \times 10^{-5}$  m<sup>2</sup> and hydraulic conductivities varying from  $1.15 \times 10^{-7}$  to  $3 \times 10^{-5}$  m/s (data from more than 500 boreholes).

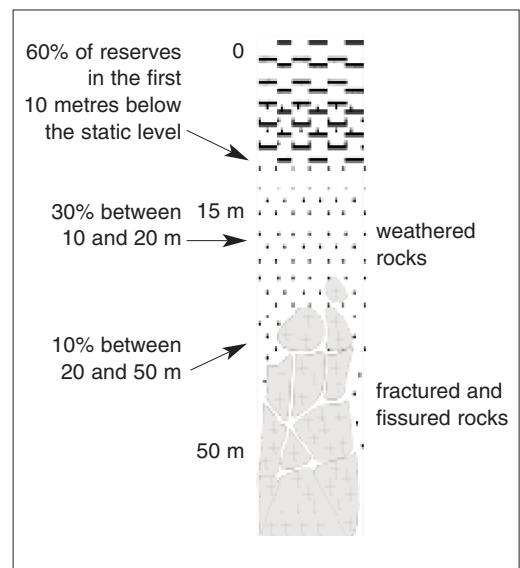


**Figure 3.16: Frequency of instantaneous flows in basement rock aquifers (BRGM 1992).**

#### Available resources

The storage capacity of a granite-gneiss zone can be calculated from its storativity. Taking a specific yield (or specific drainage) of 5% for the saturated weathering products and fissured zone with a 15 m thickness, and a specific yield varying from 0.1% at 15 m to 0% at 50 m for the bedrock, the distribution of potential reserves shown in Figure 3.17 is obtained.

Even though this distribution is notional, it reflects the storage role of the weathering products and the flow role of the fissured area. This reserve corresponds to an available volume of water: however, it also has to be supplied. For the weathering products reservoir, the direct supply threshold is usually taken to be 400 mm in the sahelian area, 600 to 800 mm in the savannahs and 1 000 to 1 200 mm in coastal forest areas.



**Figure 3.17 : Reserves in the bedrock zone.**

**Table 3.IX: Recharging in a bedrock area.**

Climate	Rain (mm/year)	Exploitable recharge (mm/year)	Exploitable volume (m³/km²/year)	Exploitable volume (m³/km²/day)
Sahelian	500	50	50 000	130
Southern-sahelian	800	65	65 000	180
Sudanese	> 1 000	160	80 000	200

### Box 3.5

#### Chotts and sebkhas.

Chotts and sebkhas are endoreic areas, true 'evaporating machines' that can be found in a sahelian area. When the piezometric level of the unconfined aquifer is located near ground level in a very arid climate, the water is taken up by evaporation. The mineral concentration dissolved in the groundwater is thus enriched up to the point of supersaturation and precipitation of those minerals. Depending on the initial mineralisation of the water, various types of development and various final conditions can be observed.

This type of phenomenon can be found either in continental or in littoral areas (supersaline lagoons).

A study carried out by BRGM from 1984 to 1991 allows orders of magnitude to be established for supply and exploitable resources in areas of schists and granites (Table 3.IX, Burkina Faso).

## 4.2.2 UNCONSOLIDATED-ROCK AQUIFERS

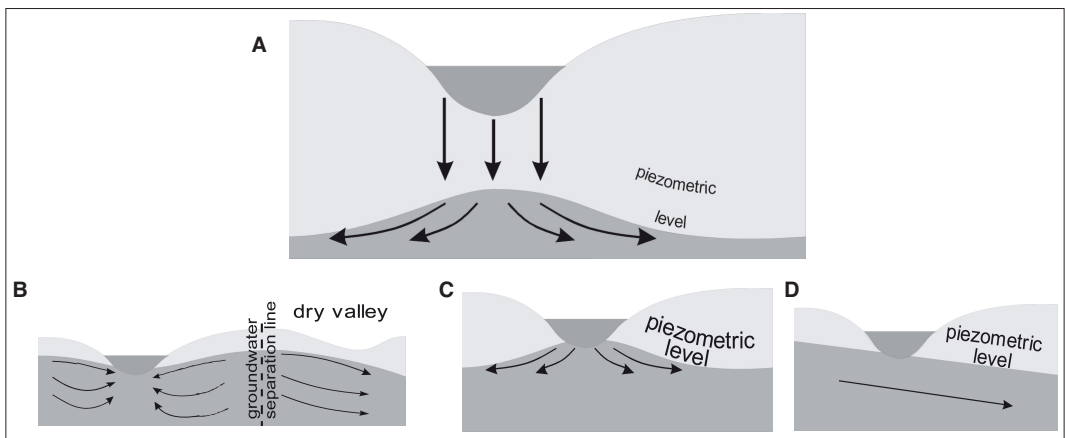
### Valley aquifers

The effective rain that infiltrates into large areas of permeable ground generally supplies unconfined aquifers. These aquifers are sometimes called groundwater tables, because they are the first to be found when sinking a well.

Their outlets are the low points of the topography: springs, streams or the sea. In a sahelian climate, direct evaporation of groundwater is possible if the piezometric levels are near the ground (Box 3.5).

The boundary conditions vary, but usually the relation between the stream and the aquifer is essential: sometimes it represents a limit to the incoming or outgoing flow.

In arid areas, the flow is concentrated in the stream (or the lowlands), which therefore supply the aquifer; these usually temporary streams are called *wadis* or *oueds* (Figures 3.18A and 3.18C). In a temperate climate, the stream usually drains the aquifer (Figure 3.18B); nevertheless, for the same stream, periods of supply (wet season, high water) and drainage of the aquifer (dry season, low water) usually occur. In the same way, a stream can change from one situation to another through all or part of its course. Finally, a stream may not have any relation with the aquifer (Figure 3.18D); this is generally the case when the bed of the watercourse is blocked.



**Figure 3.18: Relations between rivers and aquifers.**

**A: perched river, supplying aquifer. B: river draining aquifer. C: river supplying aquifer.**

**D: independent river, bed blocked.**





**Figure 3.19: Alluvial terraces.**  
**A: nested terraces. B: multi-stage terraces.**

*Alluvial aquifers*

These aquifers are located in the alluvial deposits of a watercourse. They are in equilibrium with the stream water, which drains and feeds the aquifer depending on the seasonal high and low water conditions.

A particular form of fluvial deposit is represented by alluvial terraces. The formation of these terraces is due to the alternation of periods of erosion and deposition induced by climatic variations (glacial periods, rainfall) and by tectonic movements (uplift, subsidence). Depending on the conjunction of these various factors, two types of terraces occur. Nested terraces constitute a single but heterogeneous aquifer (Figure 3.19A), while multistage terraces constitute independent aquifers, sometimes underlined by lines of springs in contact with the substratum (Figure 3.19B).

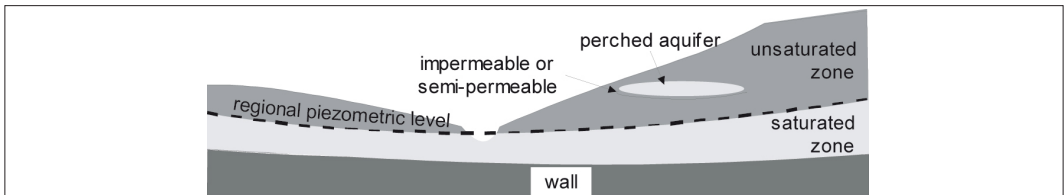
When the alluvial deposits have not been recently disturbed, the coarsest sediments are usually found at the bottom of each terrace (positive granular classification). The thickness of these alluvial deposits can be very great. In general, the permeability of the coarsest materials is very good and determines a type of aquifer with a strong flow function but a moderate storage function. The rate of renewal of water is generally high, but the quality of the water must be checked when the aquifer is fed by a stream.

This type of aquifer is the most obvious, since it is indicated by the presence of the stream and associated vegetation. It is generally exploited in a traditional manner, but it is nevertheless necessary to pay attention to the stream/aquifer relationship in order to avoid an unpleasant surprise: the exploratory boreholes sunk by ACF in the alluvial deposits of the Juba River in Awdegle (Somalia 1993) turned out to be dry, because the stream bed was blocked and the alluvial aquifer was absent in this part of the region.

*Perched aquifers*

These aquifers are mainly formed in sedimentary deposits when a low permeability layer (often clayey) in the unsaturated zone creates a small aquifer situated above the main reservoir (Figure 3.20). The extent of these aquifers can be limited and reserves poor. They can also be perennial or seasonal. When sinking wells, it is important not to mistake a perched aquifer for the unconfined aquifer that is being sought.

One example is the perched aquifers of the sandstones of the Bateke plateaux of the Congo basin (1998 ACF exploratory mission). Created by horizons of impermeable siliceous rocks, these aquifers have, in some places, piezometric levels of several tens of metres higher than that of the deep aquifer of the sandstones.



**Figure 3.20: Perched aquifer.**

### Coastal sandbars

Sandbars have developed in numerous places along the African coast. The thickness of these sands can be sufficient to allow the creation of a freshwater aquifer, a sort of lens in contact with the salt water of the ocean on one side, and the supersaline water of the lagoons on the other. The geometry of these aquifers depends greatly on abstraction and supply conditions, but they are vulnerable because they are subject to saline intrusion.

In 1994 ACF sank a 12-m well on a beach of this type in Monrovia. The water remained fresh at an abstraction rate of 1 m<sup>3</sup>/h (the annual rainfall is about 5 m).

### 4.2.3 AQUIFERS IN MAJOR SEDIMENTARY BASINS

These reservoirs are made up of a succession of more or less heterogeneous strata of various types corresponding to successive sedimentation episodes (Figure 3.21). All the formations can contain aquifers, but their function, quality and exploitation potential vary depending on depth.

There are three main types of system:

- *Unconfined aquifers* generally acts like water table aquifers or alluvial aquifers. Their supply area is proportional to their extent, which can be quite considerable, producing an aquifer with a large storage capacity.

- *The multi-layer aquifer* is formed by a group of permeable levels separated by less permeable or impermeable levels. The leaking phenomena, which allow a relation between two aquiferous levels divided by some semi-permeable material, can play an important role and thus enable the system to be considered as unified but multi-layered. The supply area of this group is generally limited to outcrop areas at the edge of the basin.

- *The deep confined aquifer* is usually poorly supplied, but can offer considerable storage capacity. The quality of the water does not always make it suitable for consumption, because of excessive mineralisation.

The limiting conditions, apart from the cases already mentioned, are sometimes created by fresh-water/salt-water contact. In fact, the flow of these aquifers moves towards the low points, oceans or seas, whereas salt water tends to infiltrate permeable terrain. If salt water is assumed to be immobile, and the fresh-water/salt-water interface without a significant mixing area, the simplified ‘de Ghyben-Herzberg’ equation can be developed:

$$H = 40 h$$

where  $h$  is the elevation of the piezometric level above sea level and  $H$  is the depth of the fresh-water/salt-water interface below sea level. This simplified relation allows the profile of the saline wedge to be calculated for constant slope (Figure 3.22). Therefore, a drop of 1m in the piezometric level (pumping, for example) induces a rise in the saline wedge of 40 m.

In fact, the actual phenomena are more complex, and the fresh-water/salt-water interface can be very large, especially when the sea level changes: this was found by ACF in the coastal plain of Mangdaw (Myanmar, 1993-1998), where the high tidal range creates a mixing area which is all the greater because of the rise of the salt water due to rivers over several tens of kilometres. Only the upper section of the aquifer in that region can be used, because beyond a certain depth (20 to 30 m) it becomes saline.

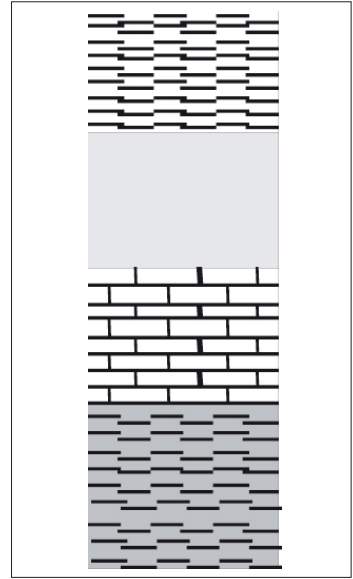


Figure 3.21: Stratified profile of a sedimentary basin.

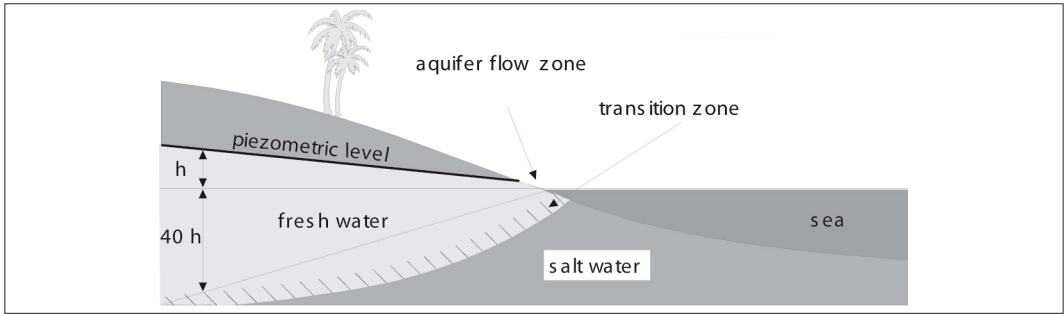


Figure 3.22: Saline wedge.

#### 4.2.4 HIGHLY HETEROGENEOUS AQUIFERS

Karst and volcanic environments are characterised by their great heterogeneity, both within and between different aquifer systems.

##### *Karst*

There are numerous definitions and various concepts of karst. It is nevertheless possible to explain some important characteristics.

The reservoir consists of carbonated rock, which can have some permeability, even if in general it is not very significant. What gives karst its originality is its macro-permeability, due to the dissolution of the rock by movement of water through preferential passages (diaclasses, fissures and fractures).

Generally, three areas can be distinguished in a karstic massif (Figure 3.23):

- An *outcrop area* (in general with little cover), sometimes called epikarst, where the rock is loose (open fissures), which can sometimes contain a small surface aquifer. Surface flow is almost absent in the epikarst because infiltration is significant. The biological activity developed charges the water with  $\text{CO}_2$ , which causes accelerated dissolving of the carbonated rock.

- An *unsaturated area*, sometimes very thick, which allows infiltration of the water coming from the epikarst. This infiltration occurs rapidly through fairly large channels, but it also occurs more slowly through fissures, diaclasses or possibly interstitial porosity. This area has a flow function, but sometimes it also has a storage function when it is thick enough, and/or when large-capacity annexed systems have developed there (cavities).

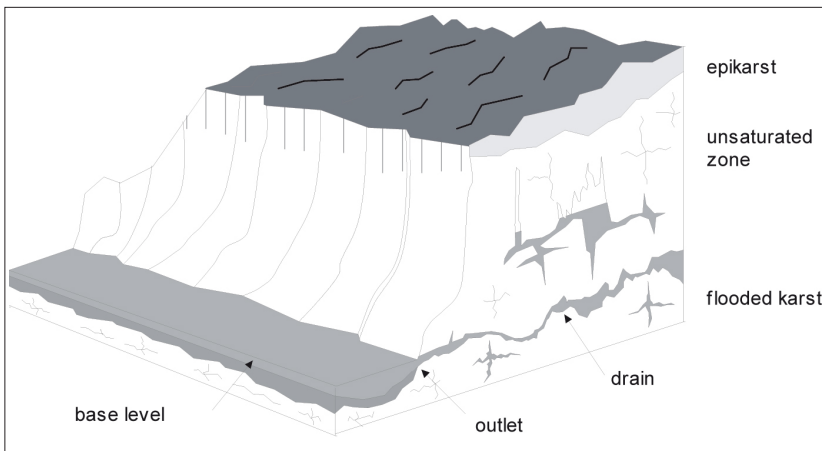


Figure 3.23: Karst.

– A *saturated area*, known as ‘flooded karst’, which has outlets of all types, though some are truly spectacular. They are karstic springs, with variable behaviour and sometimes with a very significant flow rate.

The karst reserves are generally important, even if their assessment is difficult. The permeability and porosity of such a strongly anisotropic environment are difficult to calculate, and the results of test pumping cannot be exploited with normal tools (see Chapter 6). The study of these environments is carried out with a whole range of tools, generally based on the study of the system’s behaviour.

The management of karsts is difficult from a quantitative point of view, but even more difficult from a qualitative point of view. Indeed, very fast flows transfer pollution easily, in directions that are sometimes difficult to predict: the protection of the aquifer is therefore difficult.

#### *Volcanic environment*

Volcanic materials are very varied, though basically they can be divided into flows, extrusions, and intrusions. Lava flows can cover very large areas and have a thickness of several hundred metres. Sometimes compact, these flows are highly permeable if they are fissured; their weathering products are generally argillaceous. The creation of flows by ‘carpet rolling’ produces a certain stratification of the environment. In the same way, flows can be stratified with projection materials (ash or tufa), the micro-permeability of which is generally quite good. There are also lava tunnels created at the time of the differential cooling of the flow, which then constitute areas of great permeability. In general, the materials of volcanic flows are more favourable to flow than to storage of water.

The seams and dykes of volcanic materials (usually of a doleritic nature) are sometimes fractured and weathered. Injected into fractures, they then provide drainage. Conversely, if they are not weathered, they can form underground barrages to groundwater flow.

### 4.3 Aquifer recharge

The assessment of the characteristics of the aquifer is carried out at a given moment, and it is unwise to consider that they will remain stable over the whole year, or from one year to the next. The best example is, without any doubt, the thickness of an unconfined aquifer affected by its supply: there are many areas where productivity has fallen after an annual or inter-annual piezometric fluctuation. An example is the boreholes of South Angola (Kunene), where productivity has become almost zero following a general decrease in piezometric levels (ACF Angola 1998).

It is also necessary to consider groundwater as a renewable resource: in the aquifer, water pumped from wells and boreholes disturbs the water cycle’s natural balance. It is therefore advisable to estimate the impact of withdrawals on the system and to make sure they do not dry up the resource. There are numerous examples of boreholes with a decrease in productivity after several months of use; as the pumped flow rate is higher than the supply rate, the system reserves are progressively used up. One example is a borehole sunk by ACF in 1996 in Sudan, where the flow rate of 5 m<sup>3</sup>/h at the end of the development period progressively decreased, to become almost non-existent two months later.

In order to calculate the recharge rate of an aquifer, its hydrological balance must be drawn up. The volume of water that goes into the aquifer is assumed to be equal to the volume of water that comes out, plus or minus changes in the stock. The balance is expressed as follows:

$$\text{input} = \text{output} \pm \text{change of stock}$$

In short-term humanitarian programmes, it is not possible to determine complex hydrological balances, since this is a considerable task requiring a long period of observation. Furthermore, withdrawal flow rates are generally quite low. Nevertheless, in programmes spread over several years, it is possible to estimate this balance by using the available data, or by directly measuring simple parameters in the field. These investigations do not allow definite conclusions to be drawn, but some recommendations may be made (see the example in Chapter 5B, Section 4).

The measurement of recharge is carried out within a known system: its geometry and hydraulic mechanism must be known for the preliminary investigations (geology, boreholes, geophysics etc.). The working scale is the hydrogeological basin. The minimum scale of observation is one year, with a monthly or 10-day measurement interval. However, measurements carried over in a single year do not allow perennial regulation mechanisms to be estimated, and therefore the results have only an indicative value.

#### 4.3.1 PIEZOMETRIC MONITORING

The simplest method of assessing the effects of exploitation of an aquifer is to carry out piezometric monitoring. Carried out monthly over a period of several years, piezometry tracks the behaviour of the aquifer, and is possible in the majority of programmes. The boreholes and wells must be chosen according to their location and the system under consideration. In practice, it is possible to start piezometric monitoring on a large number of wells in order to be able to draw a map as close as possible to reality. To alleviate logistics constraints, only the analysis of wells regarded as representative is then followed up.

#### 4.3.2 SIMPLIFIED WATER BALANCE

Bearing in mind the constraints linked to humanitarian interventions, it is only possible to calculate the hydrological balance of relatively simple systems, where the inputs and outputs are easily quantifiable. Such systems present a balance similar to that shown in Table 3.X.

Two methods are used, and the balance is checked by comparing the two results. The upstream approach consists of calculating recharge by estimating the inputs to the system. The downstream approach estimates recharge from measurement of the outputs from the aquifer. The estimation can only be regarded as satisfactory if the two methods give similar results.

**Table 3.X: Simplified balance.**

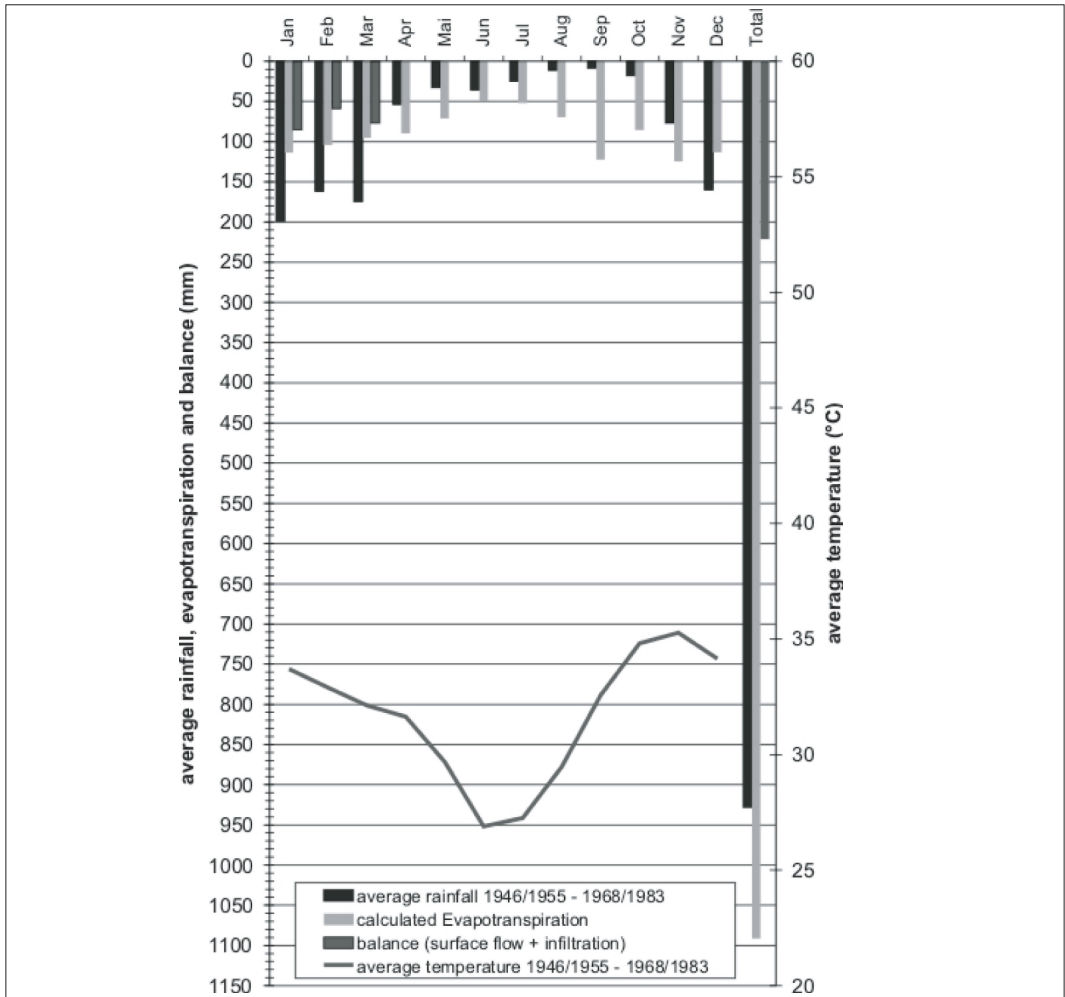
Input	=	Output	+/-	Stock change
Useful rainfall (UR) + surface water infiltration (Is)	=	Flow rate of the springs + base flow rate of the streams (Qs) + pumping (Qp)	+/-	Stock change ( $\Delta s$ )
(UR + Is)	=	(Qs + Qp)	+/-	( $\Delta s$ )

Moreover, the balance thus calculated can be verified by the hydrogeological approach: the underground flow rate calculated by Darcy's equation ( $Q = KAi$ ) must correspond to the infiltration flow rate calculated by the balance method (+/- the changes in the stock).

Steps in the implementation of these methods are presented in Annex 6, and an example is given in Figure 3.24.

## 4.4 Groundwater quality

Groundwater has a reputation for being of good quality for human consumption. Biological, and especially microbiological contamination risk of this resource is extremely limited. However, the presence of mineral toxicity (natural pollution such as arsenic or fluorine) may occur, potentially leading to chronic health problems. When this type of natural pollution risk exists, rain or surface water become an alternative resource. Groundwater is generally less sensitive to various types of pollution than surface water (except in fractured contexts and karsts). The different types and interpretations of water analysis as well as measures for the protection of groundwater are presented in Chapters 4 and Annex 10.



**Figure 3.24: Water balance of Caia district prepared by ACF (Mozambique, 2000) with local data and using the upstream approach. The calculation is based on the Thornthwaite method (see Annex 6) with a monthly calculation step.**

#### 4.4.1 HEALTH ASPECTS

The essential elements (major ions), as well as certain trace elements (iron, zinc, copper, manganese etc.), are considered important for human health. Groundwater can supply the essential daily intake of some of these minerals, but a varied and balanced diet is the best way to ensure sufficient intake.

Toxic elements may lead to acute health hazards if ingested at high concentrations, or may lead to chronic diseases if consumed at low levels over an extended period. Drinking water quality guidelines and regulations (e.g. WHO guidelines and national standards) have been developed on the basis of known or supposed risks to health.

Except in the case of agricultural contamination (pesticides, fertilisers or manure), chemical pollution of groundwater is mainly of natural origin, induced by the interactions between the rock and the water (leaching and dissolving). These interactions can create acceptance problems (e.g. in case of excessive conductivity or high iron presence), that can put people off a water source which is in

fact potable from a sanitary point of view. It may also present a health risk (e.g. chronic diseases linked to mineral toxicity). Nevertheless, the biggest problem remains microbiological pollution of water.

#### 4.4.2 CHEMICAL SIGNATURES

An analysis of the major chemical elements present in water enable it to be characterised. By comparing various analyses, it is possible to identify the chemical ‘signatures’ that correspond to different aquifer systems. It is thereby possible to differentiate various types of water as, for example, has been shown in numerous studies carried out in West Africa on bedrock groundwater.

Table 3.XI shows the average values of selected parameters for various types of aquifer in West Africa and Table 3.XII summarises the results of water-quality monitoring carried out by ACF in Uganda.

**Table 3.XI: Quality of bedrock groundwater (from University of Avignon 1990).**

Quality	Aquifer	pH	Conductivity ( $\mu\text{S}/\text{cm}$ )	Mineralisation (mg/l)
Medium	Granitic gravel	7.2	125	122
	Schist gravel	7.6	172	165
Inferior	Fissured schists	7.9	404	326
	Fissured granites	6.6	380	386
	Old sandstones	6.9	190	251

**Table 3.XII: Quality of bedrock groundwater.  
Annual average values 1996-1998 (ACF Uganda).**

Water source	Quality	Aquifer	Conductivity ( $\mu\text{S}/\text{cm}$ )	Temperature ( $^{\circ}\text{C}$ )
Boreholes (40)	Medium/inferior	Granite-gneiss sands	180-400	24-26
Springs (5)	Superior	Weathering products	100-130	24-27

The analysis of the intrinsic isotopes of the water (deuterium  $^2\text{H}$  and oxygen  $^{18}\text{O}$ ) as well as the stable isotope  $^{13}\text{C}$  enables the origin of the groundwater to be traced. Analysis of the radioactive isotopes ( $^3\text{H}$  and  $^{14}\text{C}$ ) gives the age of the groundwater (time of transit).

Humanitarian programmes are sometimes confronted with complex water-quality problems. Chemical analysis (major ions, trace elements, toxic minerals) is a necessary tool for understanding a hydrogeological context. The assistance of a laboratory is sometimes indispensable.



# Water quality and analysis

<b>1</b>	<b>Water quality and programme strategy</b>	98	3.3.4	<i>Conductivity and total dissolved solids</i>	116
1.1	Water quality and public health	98	3.3.5	<i>Dissolved oxygen</i>	117
1.2	Water quality and programme profile	98	3.3.6	<i>Hardness</i>	118
1.2.1	<i>Emergency programmes</i>	98	3.3.7	<i>Temperature</i>	118
1.2.2	<i>Long-term programmes</i>	99	3.3.8	<i>Turbidity</i>	118
1.3	Water quality through programme steps	99	3.4	Major ions	119
1.3.1	<i>Selection of water resource</i>	100	3.4.1	<i>Calcium and magnesium</i>	119
	1.3.1.1 The quality of water resources at regional level	100	3.4.2	<i>Chlorides</i>	119
	1.3.1.2 Water-quality checking at the water point	101	3.4.3	<i>Iron</i>	119
1.3.2	<i>Water-quality monitoring</i>	102	3.4.4	<i>Nitrates and nitrogen compounds</i>	120
	1.3.2.1 Monitoring the quality of delivered water	102	3.4.5	<i>Phosphate</i>	120
	1.3.2.2 Monitoring at household level	102	3.4.6	<i>Sodium and potassium</i>	120
1.4	Water resources and water quality	103	3.4.7	<i>Sulphate and hydrogen sulphide</i>	121
1.4.1	<i>Rainwater</i>	103	3.5	Trace-elements and toxic minerals	121
1.4.2	<i>Surface water (rivers)</i>	103	3.5.1	<i>Arsenic</i>	121
1.4.3	<i>Static surface water (village ponds)</i>	104	3.5.2	<i>Chlorine</i>	122
1.4.4	<i>Groundwater</i>	105	3.5.3	<i>Fluoride</i>	122
<b>2</b>	<b>Standards and guidelines</b>	106	3.5.4	<i>Lead</i>	122
2.1	The concept of pollution	106	3.5.5	<i>Manganese</i>	122
2.2	The concept of toxicity	107	3.5.6	<i>Other elements</i>	122
2.3	Quality standards, guidelines and indicators	108	3.6	Biological indices	122
2.3.1	<i>Practical use of water-quality standards</i>	108	<b>4</b>	<b>Water analysis</b>	123
2.3.2	<i>WHO guidelines, third edition (2003)</i>	109	4.1	Sampling	123
	2.3.2.1 Health-related guidelines	109	4.1.1	<i>Methodology</i>	123
	2.3.2.2 Non health-related guidelines (recommendations)	110	4.1.2	<i>Container materials</i>	123
2.3.3	<i>The Sphere project 2004</i>	111	4.1.3	<i>Modifications and preservation of the samples</i>	123
<b>3</b>	<b>Quality indicators</b>	112	4.1.4	<i>Specific recommendations</i>	124
3.1	Sanitary surveys and risk assessments regarding water quality	112	4.1.4.1	Samples for bacteriological analysis and BOD	124
3.2	Biological analysis	114	4.1.4.2	Chemical parameters	125
3.2.1	<i>Pathogenic organisms present in water</i>	114	4.2	Methods of analysis	125
3.2.2	<i>Bacteriological analysis</i>	114	4.2.1	<i>Methods</i>	125
3.3	Physicochemical characteristics	115	4.2.1.1	Bacteriological analysis	125
3.3.1	<i>Acidity (pH)</i>	115	4.2.1.2	Chemical analysis	126
3.3.2	<i>Alkalinity</i>	116	4.2.2	The use of a mini-lab	127
3.3.3	<i>BOD, COD and oxidability</i>	116	4.3	Presentation of results and interpretation	128
			4.3.1	<i>Presentation of results</i>	128
			4.3.2	<i>Representativeness</i>	129
			4.3.3	<i>Interpretation</i>	129

Water quality is defined by physical, chemical and biological parameters, but also on the characteristics of the water resource, the supply system and the final utilisation.

Water quality standards depend on the intended use of the water: human consumption (for drinking, cooking, domestic and personal hygiene), food production (crops or livestock), industry and the environment.



However, in humanitarian programmes, water-quality aspects related to human consumption are the most important, because of their implications for health.

Different sets of standards exist, and many countries have their own reference standards, but the most widely recognised worldwide guidance on water-quality standards is provided by the World Health Organisation (WHO).

Respecting water-quality standards may be difficult and may require the development of non-sustainable systems for a community. In these cases, a system that produces less than perfect quality water may be appropriate, and certain critical quality parameters should be met to cope with major health risks. Having water in a sufficient quantity must be the first priority, to allow water consumption, food production and hygiene activities to be undertaken.

Not all situations have the same health risks. A crowded refugee camp with no water and sanitation facilities has a high health risk, and programme implementation must pay special attention to water quality. Attention to water-quality standards is more necessary at nutritional or health centres than at community water points.

## 1 Water quality and programme strategy

### 1.1 Water quality and public health

A sufficient quantity of good-quality water is essential for health. An important proportion of water-related diseases is directly linked to poor water quality, characterised by chemical or microbiological contamination (Table 4.I).

Diarrhoea is one of the major global health problems, with around 4 billion cases each year (WHO 2000). Lack of access to clean water is one of the main factors of transmission routes of diarrhoea. Many infectious diseases are transmitted by pathogens in human faeces via the faecal-oral route, which is the main link between water quality and public health. The aim of most water and sanitation programmes is to block potential disease-transmission routes, using water-quality surveillance to monitor these routes and assess the effectiveness of the programme.

**Table 4.I: Disease groups related to water quality.**

Group	Example of diseases
Water-borne diseases (caused by consumption of biologically contaminated drinking water)	Cholera Typhoid Infectious hepatitis Giardiasis, Amoebiasis
Water-based diseases	Schistosomiasis, Dracunculiasis (guinea worm)
Diseases caused by consumption of chemically contaminated drinking water	Fluorosis (fluoride), Skin cancer (arsenic) Lead poisoning

### 1.2 Water quality and programme profile

#### 1.2.1 EMERGENCY PROGRAMMES

Emergency contexts are normally characterised by a high vulnerability of the population and a high risk of epidemics. Therefore, rapidly and efficiently covering the basic needs of the population is the priority. This is the case in the setting up of camps for refugees or displaced persons.

In these contexts, microbiological water quality is a major issue, considering that numerous outbreaks are related to water quality. Treatment of water is therefore highly recommended, and the most common process employed is chlorination.

When water is clear, chlorination removes faecal contamination (though it is less effective against most viruses, protozoa cysts, and helminth ova than against bacteria). Turbid water needs pre-treatment before chlorination, and it is usual practice to flocculate it with chemicals. Residual chlorine will protect water from further bacteriological contamination during a limited period of time after the initial disinfection. Monitoring of residual chlorine must be done on a daily basis at the distribution points.

Water-quality monitoring should be systematic and properly reported:

- daily monitoring of the water treated through the measurement of free residual chlorine (with a pool tester) at the water distribution sites (taps) and therapeutic feeding centre/ health centre storage containers;
- if chlorination is not done, regular random checking of microbiological contamination (faecal coliform counts);
- if chemically-assisted sedimentation is done, daily chemical analysis (to measure the quantity of flocculants necessary and to check the water treated).

*Note.* – The short-term nature of emergency programmes (limited to several months in general) means that risks of developing chronic diseases through ingestion of chemical contaminants is limited and not considered a priority. Verification of organoleptic parameters (taste, smell – including chlorine – and colour of the water) and physicochemical parameters (especially conductivity) is of little use and should be considered only if the population to be served find the water unacceptable.

## 1.2.2 LONG-TERM PROGRAMMES

These programmes have a more community-focused approach, and are therefore directed towards the self-reliance of the population in both the use of the water source and the maintenance of water quality throughout the distribution chain (water point to household water storage).

In this context, the appropriate selection of the water source (and its use) should ensure that:

- the chemical quality of the water does not have a negative impact on public health (special attention must be paid to the potential risks of chronic diseases due to toxic chemicals like arsenic, fluoride etc.);
- the population accepts to drink the water delivered (no problems regarding taste – including chlorine – salinity, smell or colour);
- the use of the water source should include sustainable control of the risk of biological contamination (proper design of water points, participation of the community and institutions in the maintenance of the infrastructure, and water-quality-monitoring).

Ensuring biological quality (protection of the water source from re-contamination, and proper use of the water) will depend on water-point management and hygiene-promotion programmes through training of trainers. The sustainability of water-quality monitoring for these programmes must be sought through a proper partnership with relevant institutions (e.g. Ministry of Rural Development) or local partners (local NGOs, local community groups etc.).

## 1.3 Water quality through programme steps

During a standard water-supply programme, water-quality analysis should be taken into account in the selection, validation and monitoring steps, and will be carried out on the water resource, at the water point, at the water distribution process and on stored water at the household level (Tables 4.II & 4.XV).

Water-quality parameters, especially microbiological parameters, can significantly fluctuate, as demonstrated in the following examples, and therefore should be regularly monitored:

**Table 4.II: Water-quality analysis purpose according to programme steps.**

Water chain	Water quality analysis purpose
Water resource	To confirm the water quality of the resource and identify (through its characteristics) its vulnerability to contamination To ascertain the need for treatment. To gather information for the study of the water source: water flow etc.
Catchment (surface-water intake, well etc.)	To check the effectiveness of the catchment, to protect against contamination (or re-contamination)
Treatment system	To adjust treatment activity To check the efficiency of the treatment
Supply system	To detect possible sources of contamination and corresponding causes (maintenance, cleanliness, technical failures etc.). To monitor the use of the water at the distribution point.
Transport and storage in the household	To study people's habits regarding the uses of the water (transport and storage) To define hygiene promotion messages in order to promote proper use of the water

– In a refugee camp, or any area with a high concentration of people using the same source of water, limited quantity of water available may have an impact on the *microbiological quality* of the water at water points that are over-used. Where sanitation is inadequate, the water source itself is at risk of contamination.

– The seasonal variation of the water resource, including the water table, springs, and rivers, may have a direct impact on the *chemical quality* of the water. High concentrations of salts, indicated by a high conductivity, are observed at the end of the dry season, or at the beginning of the rainy season, with the release of chemicals in the aquifers via mineral leaching or during floods.

### 1.3.1 SELECTION OF THE WATER RESOURCE

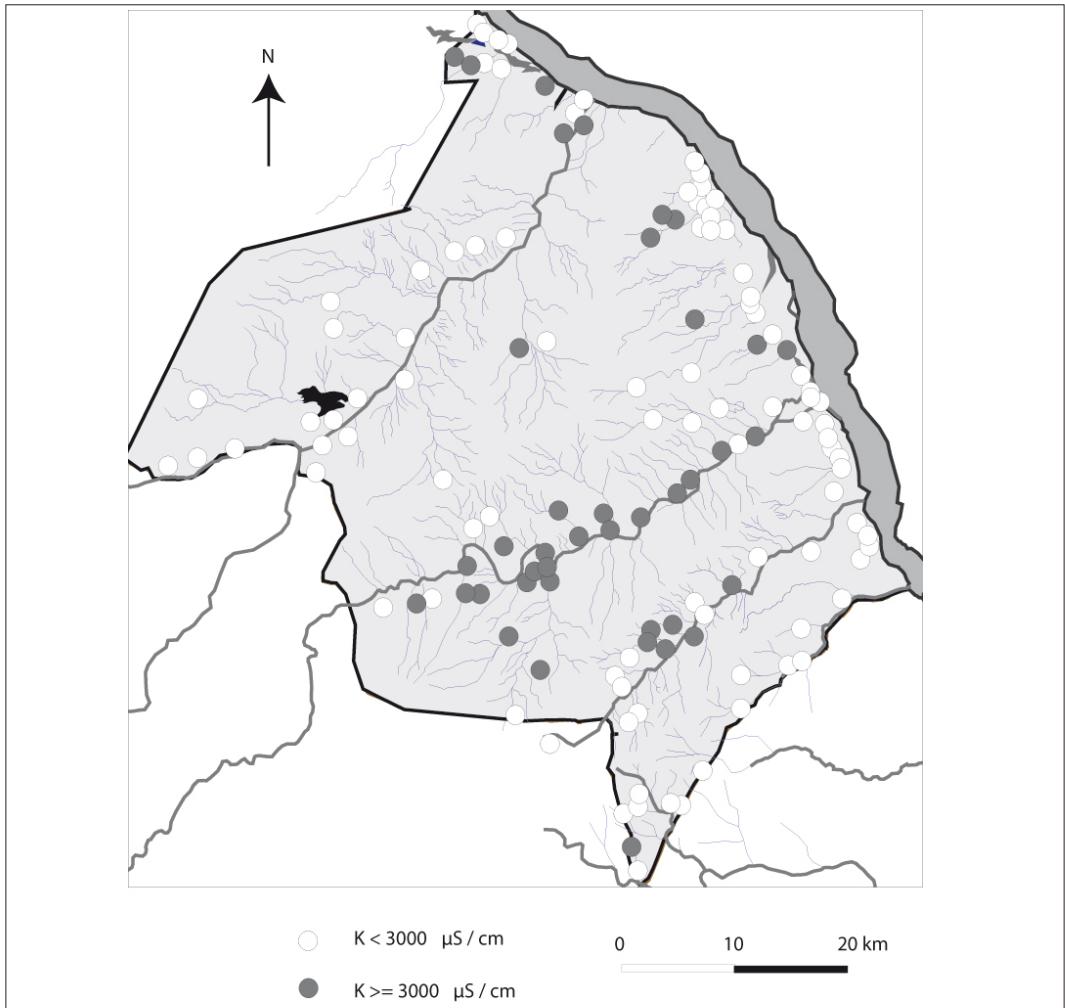
#### 1.3.1.1 *The quality of water resources at regional level*

In many situations it is very difficult to modify the chemical quality of the raw water in a sustainable way, and therefore, chemical parameters must be assessed carefully before starting a programme, especially for long-term interventions where chronic diseases are a real risk (e.g. skin cancer linked to high free arsenic concentrations in the water).

While assessing the hydrological parameters of the water resource (e.g. by a random survey of different existing water points), the chemical aspects of water quality are checked, to establish the technical feasibility of the project and its sustainability (the water resource could be potentially affected by natural pollution). This survey may influence technical choices for development of the future water points and it is fundamental for the choice of the water source (e.g. prefer shallow wells to boreholes if there is potential mineral toxic contamination with arsenic or fluoride).

Some parameters can present a geographical variability, so this data must be reported on maps presenting each of the main chemical forms (major parameters, conductivity and, possibly, toxic minerals). On the other hand, chemical parameters are subject to seasonal variation (conductivity, toxic minerals) and must be monitored at selected sites (stations) clearly registered and identified through mapping.

Water-quality surveys should be cross-checked with medical data (e.g. dental fluorosis rates, figures for skin cancer due to free arsenic in the water etc.) in order to define the major risks related to water quality.



**Figure 4.1: Conductivity mapping (ACF Mozambique, 1999).**

If the only available water resource is dangerous for human consumption (most of the time, surface water or rainwater are an alternative when groundwater resources are affected by chemical pollution), and treatment is not affordable, the agency may decide to cancel the programme, applying the principle of precaution. This critical decision should be taken after discussions at the highest level and be accompanied by lobbying of relevant national or international institutions to raise awareness of the risks and encourage a search for other solutions.

The map shown in Figure 4.1 was drawn during a feasibility study. It aims to identify zones where conductivity is  $>3000 \mu\text{S}/\text{cm}$  (dark spots), with a serious risk of acceptance problems. In these places, an alternative water source, such as rainwater or surface water was recommended.

#### 1.3.1.2 Water-quality checking at the water point

After completion of the technical work, chemical and microbiological parameters are analysed to confirm water quality (partly for contractual purposes vis-à-vis local institutions or the community) before the installation is handed over.

In the case of rehabilitation of a water point or network, two microbiological quality checks (*E. coli*) must be done (before and after the technical intervention) in order to measure the impact of the activity.

*Note.* – During the construction of water points, some parameters can be checked in order to anticipate problems. For example, regular conductivity measurements are done during drilling. In case of suspicion of the presence of toxic substances, more specific analysis can be undertaken (for example, arsenic, which is a potential problem in countries along the Mekong Delta and in Nepal, is now checked by ACF during drilling in Cambodia).

### 1.3.2 WATER-QUALITY MONITORING

#### 1.3.2.1 *Monitoring the quality of delivered water*

Monitoring the quality of delivered water concerns the risk of re-contamination in the system. The purpose is to detect the source of contamination and its causes, and it must be conducted at all the stages of the system (catchments, storage, pipelines and distribution points).

Contamination can be due to technical faults or lack of maintenance (e.g. microbiological contamination by re-infiltration of the water that has been drawn, through faults in a well's apron, or inadequate sealing around the upper part of a borehole, absence of perimeter fence etc.). Contamination of a water point / distribution network may also be linked to problems in the surrounding environment, such as inadequate sanitation, use of fertilisers on nearby fields, industrial activity in the catchment area etc.

Parameters to be monitored at the water point / distribution network are mainly biological (algae etc.) and microbiological (faecal coliforms), and the monitoring can be done through:

- Routine monitoring of microbiological water quality. The frequency of the analysis depends on the likelihood of specific risks (outbreaks) and the condition of the system.
- Sanitary inspection of the water point / distribution network: this activity, to be developed together with the relevant local institution, is an overall checklist for each type of water supply to check the state, use and maintenance of the installation (e.g. is the apron cracked or damaged? etc., See Annex 7B). The water committee responsible must be involved in these tasks.

In case of a regional toxic risk, monitoring of the major chemical parameters is carried out twice a year (after the end of the dry and rainy seasons) to check the suitability of the water source.

#### 1.3.2.2 *Monitoring at household level*

This is the most important aspect because it directly affects the health of the targeted population. It is also the most difficult to check; it concerns the entire distribution chain, from the point where water is delivered, to the homes of consumers (in practice, a sample of households is chosen); it may change from one household to another (depending on water-transport or water-storage practices, hygiene behaviour etc.); it may also change over time (for instance, during the rainy season, people may use water from unprotected sources such as seasonal pools and streams, and the quality of this water needs to be monitored too).

The main parameter to take into account is *faecal pollution* (indicated by faecal coliform counts), which must always be checked by a *sanitary survey* (cleanliness, domestic water storage conditions, hygiene practices etc.).

The interventions to preserve the quality of water at the household level are mainly hygiene promotion, and providing the means to practice good hygiene, e.g. proper drinking-water storage or proper sanitation facilities.

## 1.4 Water resources and water quality

### 1.4.1 RAINWATER

#### *General remarks on quality*

The main advantages of rainwater for human consumption are:

- Very low risk of biological contamination.
- Very low conductivity.
- Very low turbidity.

Long-term reliance on rainwater alone may cause health problems due to its low mineral content.

#### *Pollution factors*

- Particles of dirt from roofs and gutters.
- Direct surface pollution and animal contamination in open harvesting systems.
- Biological contamination (algae, parasites, bacterial) of the major storage tank.
- Development of an turbidity in the case of lack of maintenance of the tank, rain catchment surfaces, gutters (mainly at the beginning of the rainy season).
- Creation of alkalinity through reaction of the water with the internal plastering of new tanks.
- Possible presence of combustion residues, factory emissions and dust, from the atmosphere, including high NO and SO<sub>2</sub> concentrations (acid rains in India). This risk is minimal in most areas.

Even if the quality of the rainwater itself is good, harvesting and storage systems are easily contaminated and the quality of water supplied is usually poor, therefore they are principally used at household level.

#### *Other disadvantages*

- Development of mosquito larvae and insects in water-storage tanks, pose a potential risk of vector-related diseases (malaria etc.).

#### *Recommended analyses*

- Regular microbiological monitoring at the main water-storage tank and at the distribution point.
- NO, SO<sub>2</sub> and pH should be checked at the beginning of the programme and once a year thereafter.

### 1.4.2 SURFACE WATER (RIVERS)

#### *General remarks on quality*

The main characteristics of surface water include the following (see also Box 4.1):

- Microbiological contamination is usually severe, particularly if the river flows through inhabited areas.
- There is a limited risk of toxic levels of mineral elements. This means that surface waters represent a suitable alternative to naturally contaminated groundwater (e.g. with arsenic or fluoride).
- They provide a quick and short-term solution to a temporary pollution problem.
- A range of biological indicators (fish, plants, algae) facilitate the identification of pollution.
- Turbidity is usually high, with the risk of adsorption of pathogens on suspended particles.

#### *Pollution factors*

- Weak protection from direct contamination risks (e.g. human or animal faecal pollution).
- Presence of organic matter (the degradation of which causes decreased dissolved oxygen levels).
- Presence of plant nutrients (e.g. from agricultural pollution) may cause eutrophication of the water.
- Possible presence of pesticides (organochlorides, organophosphates, carbamates etc.), if their use is common in the area.

#### Box 4.1

##### Specific phenomena of surface-water quality.

###### *The natural evolution of surface-water quality*

The water quality of a river undergoes a natural evolution from the source to the mouth:

- Profile evolution through regressive erosion: the upstream reaches transport coarse material, the downstream reaches carry finer particles, and finally deposits.
- Physicochemical evolution and mineralisation: concentrations of organic matter and dissolved minerals increase from upstream to downstream, with a lowering of dissolved oxygen and an increase in water temperature.
- Biological evolution: increase in biological activity, and of bacterial presence in particular, from upstream to downstream, with involvement in the decomposition of organic matter.

###### *Pollution of surface water with organic matter*

The introduction of organic matter in a river course will provoke a modification of its natural environment downstream.

- Lowering of dissolved oxygen, due to aerobic degradation of the organic matter: this represents a phenomenon of auto-purification under specific conditions.
- Modification of physicochemical parameters: temperature, pH and ammonia (NH<sub>3</sub>) increase.
- Sedimentation of anaerobic mud, with the release of methane gas (CH<sub>4</sub>) and iron sulphide (iron pyrites).
- Increased mineralisation that may cause eutrophication.

###### *Eutrophication*

- The phenomenon is the same whether caused by natural processes (e.g. seasonal algal blooms in lakes) or artificial events (pollution, excess of mineral elements, phosphates due to detergents etc.).
- The steps are: increase of the phytoplankton population, increase of turbidity, concentration of algae in the upper layers and sudden death of vegetation (due to high temperature) followed by settlement of the organic matter, decrease of the oxygen levels, and diagenesis.
- Eutrophication leads to a significant increase of pH, linked to a release of toxic substances such as NH<sub>3</sub> that impair drinking-water quality.

#### *Recommended analyses*

- Regular biological analyses, turbidity, and conductivity, which is an indicator of occasional pollution.
- Complete checking of major elements and toxic minerals when starting the programme, and then twice a year (end of rainy and dry seasons to account for any concentration / dilution phenomena).
- Regular analysis of PO<sub>4</sub>, NO<sub>3</sub>, K, mainly for the risk of agricultural pollution, including pesticides or fertilisers, or if the monitoring of conductivity shows an unexpected increase.

#### 1.4.3 STATIC SURFACE WATER (VILLAGE PONDS)

##### *General remarks on quality*

The biological and chemical characteristics of the pond water include the following:

- The presence of parasites that may represent a health risk through consumption, e.g. contamination of drinking water by the *Fasciolopsis* intestinal fluke, or through contact, e.g. *Schistosoma cercariae* penetrating the skin.
- The presence of bacteria (possibly pathogenic, e.g. *Salmonella* spp.) depends on the natural conditions and on the pond's fresh water supply. Where ponds are filled by surface run-off, there is a high risk of faecal contamination.
- A limited concentration of natural toxic minerals (ponds may represent a useful alternative to mineralised groundwater).
- Active anaerobic mineralisation involving a rapid recycling of organic matter (auto-purification).



- A whole range of biological indicators (fish, plants, algae) facilitating the identification of pollution.

#### *Contamination factors*

- Faecal contamination of the village pond, especially due to domestic animal presence and water-sharing with cattle.
- In the case of floods or cyclones, ponds, in addition to wells, are especially vulnerable to any surface contamination.
- In the case of agricultural pollution, ponds (and lakes) may concentrate toxic elements (as is the case of the Aral sea and the related lakes of Karakalpakstan).

#### *Recommended analyses*

- Direct observation of biological indicators, parasites, mosquito larvae.
- Direct observation of possible faecal contamination (dung, animal tracks).
- Regular bacteriological analyses (faecal contamination indicators).

#### *Negative factors*

- These areas may contribute to the general insalubrity of the area (malaria, mosquitoes, swamp gas (CH<sub>4</sub>)).

*Note.* – Ponds are different from lakes, because of their limited depth, and they have specific environmental characteristics:

- sunlight can reach the bottom, allowing colonisation by rooted vegetation;
- the water temperature is homogeneous (no thermocline, which is present in lakes);
- the presence of dissolved mineral elements is homogeneous.

### 1.4.4 GROUNDWATER

#### *General remarks on quality*

Generally, groundwater is of good microbiological quality and is not vulnerable to external pollution. Exceptions to this include karst systems with rapid water infiltration, or where there is insufficient filtration of surface pollution in surface-soil layers.

This good microbiological quality, especially with abstraction through boreholes, makes groundwater ideal for human consumption. The main risk is one of natural chemical contamination, such the abundance of toxic minerals (e.g. As and F) in very specific contexts.

*Note.* – The excellent biological quality of groundwater is due to:

- the filtration and fixation of biological elements by the soil (see Chapter 13, Section 3.5);
- the anaerobic conditions that limit the bacterial (and organic) presence;
- the lack of light that limits the presence of phototroph bacteria;
- the low and stable temperature and generally very low concentration of nutrients that limit bacterial growth.

#### *Pollution factors*

The good biological quality of groundwater may be threatened by contamination from the surface, mainly linked to an inappropriate exploitation of the resource (improper water-point design and lack of protection).

- The aquifer's vulnerability is closely linked to the possibility of transit of surface pollution through the non-saturated zone, and the behaviour of the pollution 'cloud' in the saturated zone (related to the transmissivity of the aquifer).

- Water flowing through mineral deposits (such as sulphate dolomites and Triassic facies, gypsum) may develop a high dissolved-solids concentration, rendering it unpalatable.

- The presence of naturally-occurring toxic minerals, due to leaching of specific rock-types or geological formations (quartzite or meta-sediments containing high fluoride concentrations, and



sulphide deposits releasing arsenic). The concentrations of dissolved elements is often linked to redox reactions: an oxidation and precipitation of elements in the upper, oxidised area of the aquifers (e.g. toxic As(III) becomes As(V)) leading to a decrease in concentration, and a reduction reaction (causing increased solubility and therefore greater availability, in the case of As) in deeper parts of the aquifer. This leads to the creation of an As-contaminated zone 20-70 m deep in the recent deltaic sediments of the Mekong River, in Cambodia.

#### *Recommended analyses*

- Complete analysis of the major elements and the main toxic minerals, to validate the resource and the water point.
- Conductivity and pH must be checked in the site-validation process.
- Microbiological monitoring of water points, to identify the main risk: biological contamination (faecal).
- Monitoring of potassium, phosphates and particularly nitrate (NO<sub>3</sub>) and pesticides (atrazine) in intensive agricultural areas (e.g. in Tajik and Uzbek cotton fields).

## 2 Standards and guidelines

### 2.1 The concept of pollution

Pollution consists of all direct or indirect factors that may affect water quality. This definition must take into account the concept of pollutant flow (evolution of the 'quantity' of pollution with time) and pollution potential (for example, the construction of latrines in a shallow water-table area).

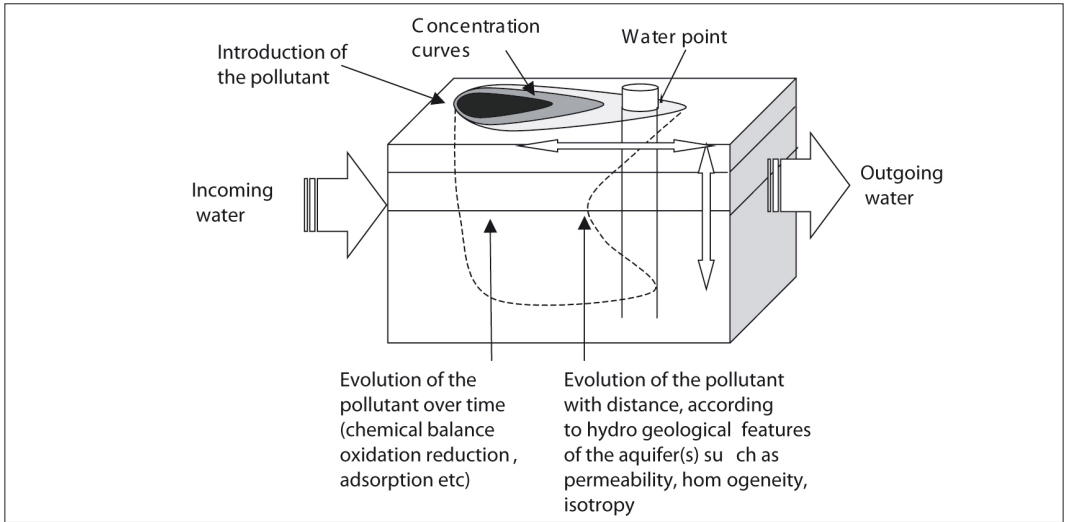
Pollution can be the result of human activities or natural phenomena (including animals and plants) and can be responsible for the poor quality of water and non-compliance with quality standards in relation with water use.

There are various types of pollutant:

- *Domestic*: faecal pollution is the main domestic cause of water pollution. Abundance of organic matter and high concentrations of mineral salts (nitrogen compounds, phosphates etc.), detergents and organochlorides must also be considered.
- *Agricultural and livestock*: pesticides and fertilisers are the main cause of agricultural pollution. Water may also contain pathogenic *E.coli* and other pathogens, from animal faecal pollution.
- *Industrial*: factory effluents (hydrocarbons, chemical products, high temperature waters) are limited risks in humanitarian intervention contexts.
- *Natural*:
  - geological pollution, caused by the release of soluble elements, such as arsenic or fluoride, into water via leaching of specific minerals (fluoroapatite, Pb-Zn sphalerite, arsenopyrite and others). These elements may be spread during specific events (river floods), by thermo-mineral springs, and natural naphtha. These processes are complex and contextual, and greatly dependent on the chemical environments of groundwater;
  - microbiological and biological pollution (bacteria, virus, fungi, protozoa, helminths);
  - physical pollution (turbidity, temperature of the water, radioactivity).

The principal source of water pollution for humanitarian programmes is related to human activities and to the faecal-oral disease-transmission cycle, mainly due to poor sanitation, contamination of the water source, improper design of water points, bad maintenance of installations and poor hygiene practices (linked to either lack of knowledge or resources to apply hygiene principles).

In other cases, specific chemical pollution due to natural toxic minerals may also appear, and, more seldom, pollution is due to the use of pesticides (e.g. in intensive agricultural activities in some Central Asian countries).



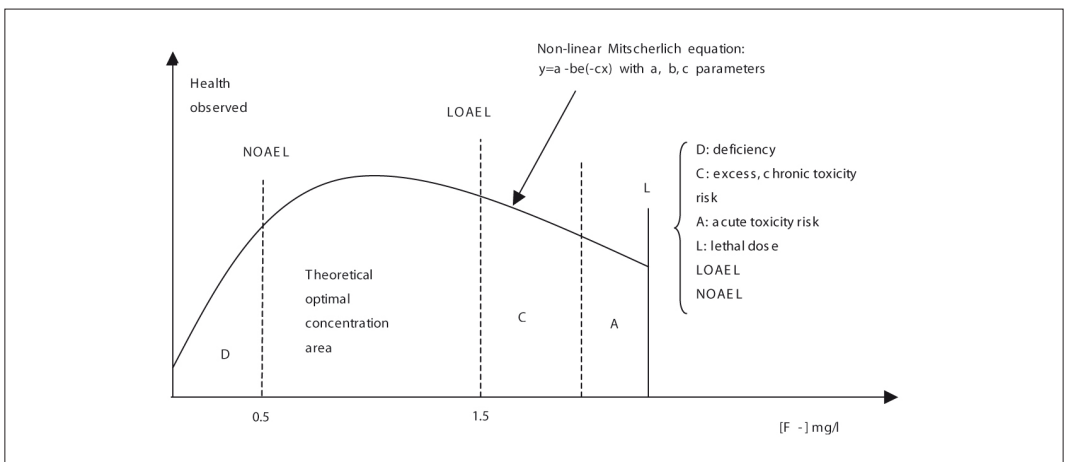
**Figure 4.2: Diffusion evolution of a pollutant in an aquifer.**

Pollution is described in terms of its spatial and temporal distribution (it can be described as a mathematical differential system where the water reservoir is represented as a ‘black box’ with pollutant concentration determined by the balance of pollutants entering and leaving it - see Figure 4.2). The main parameters of pollution to be considered are; its intensity (acuteness), its physical distribution (diffuse or localised pollution, vertical variability etc.), and its evolution over time.

Pollution can be chronic (continuous addition of pollutant), occasional, or cyclical (for example, pollution flow linked to amount of rainfall). Pollution is often specific to a type of water resource (surface water or groundwater).

## 2.2 The concept of toxicity

An element becomes toxic in water above a specific concentration, but may be beneficial or even essential for human health at lower concentrations, as illustrated in the Misterlich diagram, below (Figure 4.3).



**Figure 4.3: Misterlich diagram.**

This type of diagram explains the case of fluoride, illustrated by the ACF program in the east of Sri Lanka. The lack of fluoride, below a concentration of 0.5 mg/l (zone 'D' on the diagram) increases the risk of dental caries. However, above 1.5 mg/l (WHO guideline, 2003), fluoride causes fluorosis, with mottling of tooth enamel and impaired development of the skeleton, through a chronic toxicity process mainly affecting children under 8 years old. Values like the Tolerable Daily Intake (TDI), the No Observed Adverse Effect Level (NOAEL) and Lowest Observed Adverse Effect Level (LOAEL) are defined by WHO, and vary with the weight of each individual.

Toxicity has different consequences, depending on the concentration of the chemical in the water:

- *acute toxicity*: violent and immediate sickness/death;
- *sub-acute toxicity*: only a certain percentage of the population is affected;
- *chronic toxicity*: the consequences appear after a long-term exposure to limited concentrations, with a cumulative effect in the organism (as in the case of fluoride and arsenic).

The main chemical elements affecting human health that may appear in water can be grouped as follows:

- *essential elements*: Na, Mg, K, Ca, Si, P, S, Cl, H, C, O;
- *toxic elements*: As, Pb, Cd, Al, Ag, Sb, Hg, U, Rn;
- *essential elements that are toxic at high levels*: N, F, Cr, Mn, Fe, Co, Ni, Cu, Zn, Se, Mo, Ba, Be.

## 2.3 Quality standards, guidelines and indicators

### 2.3.1 PRACTICAL USE OF WATER-QUALITY STANDARDS

Water-quality standards refer to substances and parameters that may have some health importance or that may affect acceptability. Nevertheless, in the comments made by WHO (see Box 4.2), it is stressed that drinking-water quality guidelines must be used bearing in mind the local context or the level of local service (average quality of water distributed, national standards, drinking-water coverage). Exceptional circumstances (war, natural disasters etc.) may prevent guidelines being strictly observed.

It is therefore essential to follow standards with common sense, making enquiries about local regulations, and comparing the quality of traditionally-consumed water with the quality of water to be supplied. Having enough reasonably clean water is preferable to having an insufficient quantity of high-quality water; lack of water to ensure a minimum level of hygiene may present more health problems than having water of medium quality.

This flexibility applies particularly to biological contamination: faecal coliforms are an indicator of faecal contamination, consequently their presence indicate only a potential risk of water contamination by pathogens (see Section 3.2.2). As the standard of 0 faecal coliforms/100ml may be impossible to reach for many water supplies (e.g. open wells), a binary approach (polluted / non-polluted water) has limited relevance. Assessing the risk of pollution, e.g. in order to determine further sanitary measures, is the most useful approach (see Section 4.3.3). This approach is also recommended by WHO (see Box 4.2).

#### Box 4.2

##### Practical use of standards according to WHO 2003.

“In many developing and developed countries, a high proportion of small-community water-supply systems fail to meet local or national quality standards. However, it should be recognized that to condemn a large number of supplies is not particularly useful and may be counterproductive. In such circumstances it is important that realistic goals for progressive improvement are agreed with the suppliers and subsequently implemented. Recognizing that achieving the Guideline may be difficult in some emergency situations it is practical to classify water quality results in terms of an overall grading for water quality linked to priority for action. Sophisticated grading schemes may be of particular use in community supplies where the frequency of testing is low and reliance on analytical results alone is especially inappropriate.”

The level of risk for the presence of pathogens, linked to faecal contamination of water, can be considered as follows, bearing in mind that the presence of specific pathogens and the susceptibility of a population to infection also need to be taken into account when considering sanitary risk:

PATHOGEN RISK	FAECAL COLIFORMS /100 ML
– low risk	0 to 10*
– significant risk	10 to 50
– high risk	50 to 100
– very high risk	> 100

\* *Some pathogens are not linked to faecal risk (e.g. some viruses, some protozoa, guinea worm etc.).*

A sanitary survey must complement bacteriological analysis to qualify the sanitary risk.

### 2.3.2 WHO GUIDELINES, THIRD EDITION (2003)

Tables 4.III to 4.V are based on the WHO nomenclature. The guidelines cover the main parameters of importance for drinking-water quality. WHO guidelines are divided into health-related guidelines, and non-health related guidelines, referring to chemical elements whose harmfulness has not been proved: for those elements, WHO makes recommendations regarding the maximum acceptable value. In some countries, those elements are covered by standards issued from official directives (See Annex 7A) e.g. the French *Alimentation en eau potable* (AEP), directives (1989).

Parameters that are difficult to measure and that do not cause frequent problems are not mentioned in this chapter (e.g. cadmium). It is however necessary to remain vigilant, particularly in urban or industrialised areas, and to contact specialists to deal with particular problems: it is also important to refer to the various guidelines for materials hazardous to health not covered by this book.

The application of the WHO guidelines for drinking-water quality should be the reference in water programmes, paying particular attention to those related to the major risks to health. In cases where the WHO guidelines cannot be applied, actions should be guided by the principle of precaution (see Section 1.3.1.1).

#### 2.3.2.1 Health-related guidelines

**Table 4.III: Microbiological quality of drinking water.**

**O: origin. H: health.**

Parameters	WHO guideline values	Interpretation (see following section)
<i>E. coli</i> or thermotolerant coliforms	0 colonies /100 ml	O, H: indicators of faecal pollution (see note in Section 2.3.1)

*Note.* – According to WHO, the most definite indicator of faecal pollution is the presence of *Escherichia coli*, a member of the thermotolerant (or faecal) coliform group. In practice, the detection of faecal coliform bacteria as a whole is an acceptable and easier alternative.

**Table 4. IV: Chemical substances that have some sanitary relevance for drinking water.****O: origin. H: health. NH: non-health.**

Parameters	WHO guideline values	Interpretation (see following section)
Arsenic (As)	0.01 mg/l	O: rocks, industrial waste (iron and steel, precious-metal processing industry) H: proven carcinogenic effect (skin cancer)
Chlorine (Cl <sub>2</sub> )	5 mg/l	O: water disinfection products
Copper (Cu <sup>++</sup> )	2 mg/l	O: corrosion of copper pipes, agricultural NH: colour and bitter taste if > 5mg/l
Fluorides (F <sup>-</sup> )	1.5 mg/l	O: rocks, fertiliser, food (fish), industrial pollution (aluminium manufacture) H: dental and bone fluorosis
Lead (Pb)	0.01 mg/l	O: natural (galena), chemical industry, lead pipes corrosion, surface treatment H: cumulative neurological toxicity
Manganese (Mn)	0.4 mg/l	O: iron-bearing rocks H: toxic effect on nervous system when > 20 mg/l NH: turbidity and taste when > 0.3 mg/l
Nitrates (NO <sub>3</sub> <sup>-</sup> )	50 mg/l	O: faecal contamination, organic matter, soil leaching, fertiliser, wastewater H: child methaemoglobinaemia
Nitrites (NO <sub>2</sub> <sup>-</sup> )	3 mg/l	O: organic matter H: child methaemoglobinaemia

### 2.3.2.2 Non health-related guidelines (recommendations)

**Table 4.V: Drinking water substances and parameters that may lead to acceptability problems.****O: origin. H: health. NH: non-health.**

Parameters	WHO recommendations	Interpretation (see following section)
<i>Organoleptic parameters</i>		
Colour	15 TCU	Nil
Conductivity	1000 mg/l 1400 µS/cm	O : dissolved solids NH: taste
Turbidity	5 NTU	O: matter in suspension, colloids, dissolved matter H: can involve bacteria presence in water through onto particles adsorption
<i>Inorganic substances / parameters</i>		
Aluminium(Al)	0.2 mg/l	O: coagulants used in water treatment, industry, natural NH: colour and acceptability problem when > 0.2 mg/l
Ammonia (NH <sub>4</sub> )	1.5 mg/l	O: nitrogenous organic matter (waste, wastewater, plants etc.) NH: taste and smell when >1.5 mg
Chloride (Cl <sup>-</sup> )	250 mg/l	O: natural (salty contexts), human (urine), industrial H: laxative effect NH: brackish taste when >250 mg/l, pollution indicator
Hardness	200 mg/l	O: presence of Calcium and Magnesium NH: taste threshold, excess use of soap to achieve cleaning
Hydrogen sulphide (H <sub>2</sub> S)	0.05 mg/l	O: rock, organic matter under anaerobic conditions H: no problem if swallowed, fatal if inhaled at high doses
Sodium (Na <sup>+</sup> )	200mg/l	O: natural, industrial H: can indicate pollution (Na is present in urine) NH: taste threshold
Sulphates (SO <sub>4</sub> <sup>2-</sup> )	250 mg/l	O: natural (rocks), industry H: laxative effect, taste problem, NH: water aggressive to concrete when >250 mg/l
Iron (Fe <sup>++</sup> )	0.3 mg/l	O: rocks, coagulants (ferric sulphate/ferric chloride) NH: aesthetic (red colour, metallic taste, rotten fish smell) ferruginous bacteria can block pipes.
Zinc (Zn)	4mg/l	O: industrial, pipe corrosion NH: becomes an agricultural pollution when concentrated in soil

### 2.3.3 THE SPHERE PROJECT 2004

The Sphere project defines standards to be used in emergency contexts (see Chapter 2). Sphere water-quality standards are based on WHO guidelines for drinking water, but also include some comments and specifications useful for emergency contexts. Extracts from the Sphere project are presented in Box 4.3.

#### Box 4.3

Extracts from Sphere standards related to water quality.

##### *Water quality standard*

Water is palatable, and of sufficient quality to be drunk and used for personal and domestic hygiene without causing significant risk to health.

##### *Key indicators*

- a) A sanitary survey indicates a low risk of faecal contamination.
- b) There are no faecal coliform per 100 ml at the point of delivery.
- c) People drink water from a protected or treated source in preference to other readily available water sources.
- d) Steps are taken to minimise post-delivery contamination.
- e) For piped water supplies, or for all water supplies at times of risk or presence of diarrhoeal epidemic, water is treated with a disinfectant so that there is free chlorine residual at the tap of 0.5 mg per litre and turbidity is below 5 NTU.
- f) No negative health effect is detected due to short-term use of water contaminated by chemical (including carry-over of treatment chemicals) or radiological sources, and assessment shows no significant probability of such an effect.

##### *Guidance notes*

Microbiological water quality: faecal coliform bacteria (>99% of which are *E. coli*) are an indicator of the level of human/animal waste contamination in water and the possibility of the presence of harmful pathogens. If any faecal coliforms are present, water should be treated.

##### – Post-delivery contamination

Water should be routinely sampled at the point of use to monitor the extent of any post-delivery contamination.

##### – Water disinfection

In order for water to be disinfected properly, turbidity must be <5 NTU.

##### – Chemical and radiological contamination

Those risks should be assessed rapidly by carrying out chemical analysis. A decision that balances short-term public health risks and benefits should then be made. A decision about using possibly contaminated water for longer-term supplies should be made on the basis of a more thorough professional assessment and analysis of the health implications.

##### – Palatability

Although taste is not in itself a direct health problem (e.g. slightly saline water), if the safe water supply does not taste good, users may drink from unsafe sources and put their health at risk. This may also be a risk when chlorinated water is supplied, in which case promotional activities are needed to ensure that only safe supplies are used.

##### – Water quality for health centers

All water for hospitals, health and feeding centers should be treated with chlorine or another residual disinfectant.

**Table 4.VI: Sphere indicators.**

Test	Sphere Standards (2004): key indicators
Turbidity	5 NTU (for purpose of disinfection)
Faecal coliforms	0 col. /100ml at the point of delivery (see note in Section 2.3.1)
Chloride, fluoride, iron (FeII), manganese, nitrates, nitrites, sulphates, arsenic	No negative health effect is detected due to short-term use of water contaminated by chemical or radiological sources A guidance note on chemical and radiological contamination
Residual disinfectant products (chlorine)	For piped water and all water supply in case of diarrhoea epidemic, water is treated with free residual chlorine = 0.5 mg/l, and turbidity <5 NTU. A guidance note on water quality for health centres on chlorine and other residual disinfectant

### 3 Quality indicators

The primary method for assessing water quality in the field is to conduct sanitary surveys, including sanitary inspections (see Section 3.1), which are complemented by bacteriological and physicochemical analyses. The type of analysis is chosen on the basis of the following objectives:

- identify possible pollution of the water (mainly bacteriological);
- characterise water before treatment, or determine the efficiency of the treatment;
- characterise the context or the resource before its exploitation;
- characterise a water point by a risk assessment approach.

The main parameters measured for reaching these objectives are listed in Table 4.VII.

#### 3.1 Sanitary surveys and risk assessments regarding water quality

Sanitary inspections of water systems and resources regard the ongoing status of the water supply and the potential risks of contamination in the long term. They are useful to identify what interventions are required and they are a tool that can be used by water-point committees to be able to monitor their water supply.

Three main types of risk factor are included in sanitary inspections:

- a) hazard factors: these are sources of faeces in the environment (e.g. pit latrines, sewers, solid-waste dumps and animal husbandry);
- b) pathway factors: these are factors that allow microbiological contamination to enter the water supply, but that are not direct sources of contamination (e.g. leaking pipes, eroded catchment areas and damaged protection works);
- c) indirect factors: these are factors that enhance the development of pathway factors, but do not directly allow contamination of the supply and are not a source of faeces (e.g. lack of fencing, faulty surface-water diversion drainage).

Sanitary inspections can be done with standardised forms depending the water system as shown in Annex 7B. These forms can be adapted to specific situations and contexts.

In the majority of cases, a sanitary inspection on its own can provide a reasonable idea of the bacteriological quality of the water and its vulnerability to pollution, but it is important to complement this information with water-quality analyses. Sanitary information can be crossed with water-quality information through risk analysis as Annex 7B also shows. Annex 7B represents an example of risk analysis adapted from the *Guidelines for drinking-water-quality, Volume 3*, WHO 1997. To implement this kind of tool requires testing and adaptation to local conditions.

**Table 4.VII: Principal indicators of water quality.**

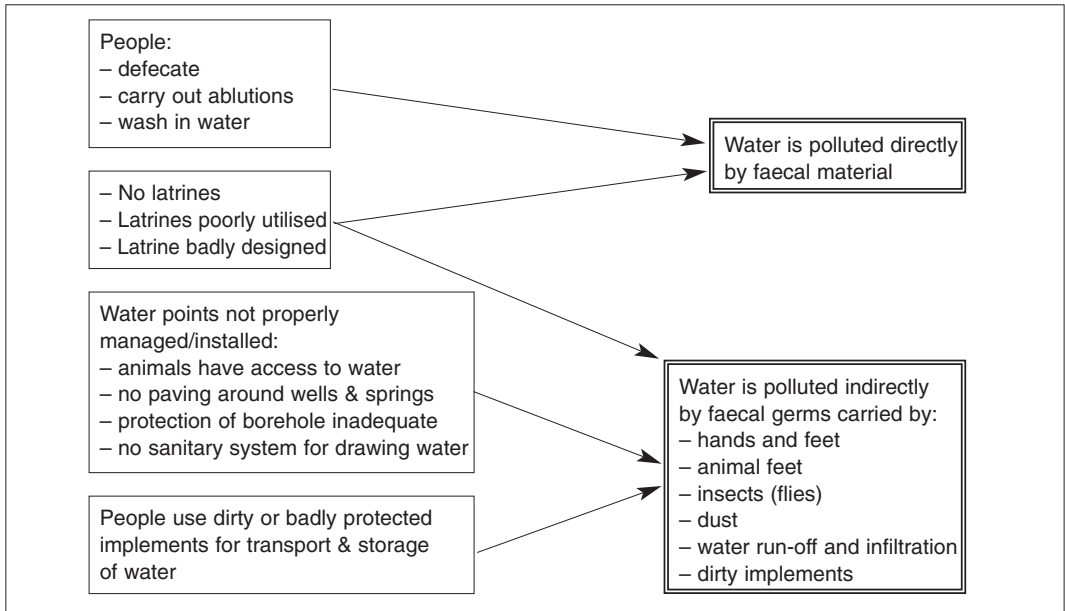
Objectives	Indicators
General analysis of the resource	Complete water analysis
a) Characterisation of a groundwater environment	Conductivity Temperature pH Cations (calcium, magnesium, potassium, sodium, trace metals) Anions (halides, sulphate, carbonate, nitrate, alkalinity) Trace elements (manganese, fluoride, arsenic)
b) Characterisation of a surface-water environment	Conductivity Temperature Turbidity pH Cations (liquid ammonium, potassium) Anions (nitrate, nitrite) Trace elements (iron, manganese) Oxidability and BOD Dissolved oxygen Biological index
Major risks to health	Sanitary survey Agricultural and industrial assessment: usages and possible pollutants (i.e. pesticides: carbamates, organophosphates, organochlorides etc.)
Faecal pollution test	Sanitary survey Bacteriological analysis
Analysis prior to treatment (filtration, chlorination, flocculation)	Bacteriological analysis Chlorine demand pH Turbidity Conductivity
Analysis after treatment	Bacteriological analysis Residual chlorine Aluminium pH Turbidity Conductivity
Analyses aimed at defining fitness for irrigation	Conductivity Cations (calcium, magnesium, sodium)

A sanitary survey is a larger exercise that includes sanitary inspection, but also analysis of factors such as disease prevalence, hygiene practices etc. that may have an impact on health. The sanitary survey offers a complete and meaningful approach to the situation. It reveals the vulnerability of water to pollution and keeps its value over time.

Sanitary surveys serve to:

- identify sources of contamination in order to define remedial actions;
- validate the water-supply system;
- assess the seriousness of a situation by analysing risks;
- compare different sources and systems in order to prioritise actions;
- identify recurrent problems in order to adapt strategies and methodologies.





**Figure 4.4: Faecal risk.**

All situations that allow faeces to come into contact with water (directly, as in defecation into water, or indirectly, as in transport by run-off) represent a potential source of pollution. The sanitary survey investigates these risk situations (Figure 4.4). It must be carried out throughout the water system, from the water point to the users' homes.

## 3.2 Biological analysis

Bacteriological analysis indicates faecal pollution of water but is also a valuable check on the efficiency of the protection or treatment measures, and is a complementary tool for the sanitary survey and sanitary inspections. It is an indicator of water quality only at the time of sampling, and does not retain its value over time, so needs to be interpreted in the light of the sanitary survey.

### 3.2.1 PATHOGENIC ORGANISMS PRESENT IN WATER

Pathogenic organisms that may be present in the water are very numerous and varied, Table 4.VIII presents the most important. The faecal-oral infections can be transmitted by either water-borne or water-washed mechanisms. Truly water-borne transmission occurs when the pathogen is in water which is drunk by a person or animal that may become infected. But all water-borne diseases can also be transmitted by any other route which permits faecal material to pass into the mouth (for example via contaminated food).

### 3.2.2 BACTERIOLOGICAL ANALYSIS

There are very many pathogens (see Table 4.VIII) that may be found in water. It is not feasible (or feasible only through expensive and time-consuming methods) to test for pathogens directly. As most pathogens in water are derived from faeces (human and animal), the approach is therefore to analyse the water for bacteria that show human and animal faecal contamination has occurred. These are called 'indicator bacteria'. Their presence in water does not prove the presence of pathogenic organisms, but provides a strong indication of it.

**Table 4.VIII: Main faecal–oral (water-borne or water-washed) water-related infections (from Cairncross & Feachem 1990).**

Infection		Pathogenic agent
Diarrhoeas and Dysenteries	<i>Campylobacter enteritis</i>	Bacterium
	Cholera	Bacterium
	<i>E. coli</i> diarrhoea	Bacterium
	Salmonellosis	Bacterium
	Shigellosis (bacillary dysentery)	Bacterium
	Yersiniosis	Bacterium
	Rotavirus diarrhoea	Virus
	Giardiasis	Protozoon
	Amoebic dysentery	Protozoon
	Balantidiasis	Protozoon
Enteric fevers	Typhoid	Bacterium
	Paratyphoid	Bacterium
Poliomyelitis		Virus
Hepatitis A		Virus
Leptospirosis		Spirochaete
Ascariasis		Helminth
Trichuriasis		Helminth

The most definite indicator bacteria (according to WHO) used in routine assessment of the risk of faecal contamination is *Escherichia coli*. This species is present in the faeces of warm-blooded animals, including humans, and is part of the normal intestinal flora of healthy individuals. It is abundant in human faeces (up to 1 billion bacteria/gram of fresh matter), and persistent enough to be detected (its detection duration in water at 20°C varies from 1 week to 1 month). *E. coli* is the most common species in the group of *thermotolerant coliforms*, or *faecal coliforms* (more than 99% of faecal coliforms in water are *E. coli*). In practice, faecal coliforms are commonly used to identify faecal contamination.

Results of bacteriological analysis do not provide definite information on the presence or absence of pathogens. Some virus and protozoa may be found in drinking-water supplies when faecal coliforms are absent, so water that contains no faecal coliforms should be seen as low risk, rather than safe. On the other hand, faecal coliform presence indicates faecal contamination, but does not prove the presence of pathogenic organisms, even if this may be strongly suspected (see risk estimation in Section 2.3.4).

Generally, faecal coliforms are not pathogenic. However, some serotypes of *E. coli* (O157:H7) may cause serious diseases: pathogenic strains of *E. coli* are responsible for urinary tract infections, bacteraemia, meningitis and diarrhoeal disease in humans. Animals, primarily cattle and, to a lesser extent, chickens, goats and pigs, are the main reservoir for pathogenic *E. coli*.

*Note.* – Total coliforms are a much larger group of coliform bacteria that are present in cold- and warm-blooded animal and human faeces, but not all total coliforms have a faecal origin, and many are present in most non-treated water sources in tropical regions, particularly in water enriched with organic matter. They are not systematically identified, as their presence does not necessarily indicate a sanitary risk, but they can be used to measure the effectiveness of treatment processes.

### 3.3 Physicochemical characteristics

Choice of parameters to be identified is based on the objective of the analysis.

#### 3.3.1 ACIDITY (pH)

The pH (hydrogen potential) measures the concentration of H<sup>+</sup> ions in the water, representing the balance between acidity and alkalinity on a scale of 0 to 14, with 7 being neutral.

**Table 4.IX: Classification of the water according to its pH.**

---

pH < 5	Strong acidity (Coca Cola® pH = 3 ; orange juice pH = 5) Presence of mineral or organic acids in natural water
pH = 7	Neutral pH
7 < pH < 8	Most surface water (approaching neutrality)
5.5 < pH < 8	Most groundwater
pH > 8	Alkalinity, intense evaporation

---

It characterises a large number of physicochemical equilibriums and depends on many factors, including the origin of the water (Table 4.IX).

It can have a direct influence on the toxicity of other elements: sulphur is present as toxic H<sub>2</sub>S under acidic conditions, but as a harmless precipitate of S<sub>2</sub> at pH>13. pH also has an influence on chlorination efficiency (best results are achieved in acidic waters, below pH 7, and chemically-assisted flocculation (aluminium sulphate is most effective between pH 6 and 8).

Analyses to be done *in-situ* with pH-meter or colorimeter.

*WHO recommendation: 6.5 – 8.*

### 3.3.2 ALKALINITY

Alkalinity corresponds to measurement of constituents from the group of weak acid anions capable of reacting with H<sup>+</sup>. The alkalinity of water is a measure of its capacity to neutralise acids. This parameter plays a major role in the buffer-effect of water. It determines the way in which pH is modified by the addition of weak acids or bases, particularly during treatment processes (flocculation and disinfection).

### 3.3.3 BOD, COD AND OXIDABILITY

These parameters enable estimation of the quantity of organic matter present in water.

BOD (biochemical oxygen demand) expresses the quantity of oxygen necessary for the breakdown of biodegradable organic matter in the water by the development of micro-organisms under certain given conditions. The conditions most commonly assumed are 5 days (partial degradation occurs by then) at 20 °C, in the absence of light and air: this is known as BOD<sub>5</sub>. This measurement is widely used for monitoring sewage-treatment-plant effluent, because it provides an estimate of the loading of biodegradable organic matter. It is expressed in mg/l (mg of O<sub>2</sub> consumed per litre).

COD (chemical oxygen demand) shows the quantity of oxygen necessary to oxidise the organic matter (biodegradable or not) in the water, using an oxidant (potassium dichromate). The result is expressed in mg/l.

Oxidability is a measurement similar to COD, and is used in the case of low concentrations of organic matter (COD < 40 mg/l). The oxidant used is potassium permanganate.

### 3.3.4 CONDUCTIVITY AND TOTAL DISSOLVED SOLIDS

Most matter dissolved in water occurs as electrically-charged ions, with ion concentrations dependent on the pH and EH (redox potential) of the water, and the composition and concentration of different negatively- and positively-charged ions that may react to form inert solids. Total dissolved solids (TDS) is defined as the quantity of dissolved material in water, and depends mainly on the solu-

**Table 4.X: Classification of water according to its conductivity  $\chi$ .**

$\chi$ ( $\mu\text{S}/\text{cm}$ )	Type of water	
0.005	Demineralised water	
$10 < \chi < 80$	Rainwater	Normally no acceptance problems for human consumption in this range
$30 < \chi < 100$	Slightly mineralised water, granitic context	
$300 < \chi < 500$	Fairly well-mineralised water, carbonated context	
$500 < \chi < 1\ 000$	Mineralised water	
$1\ 000 < \chi < 1\ 500$	Highly mineralised water	
$1\ 500 < \chi < 3\ 000$	Brackish water	
$\chi > 20\ 000$	Seawater	

bility of rock and soil minerals in contact with waters within normal pH and EH ranges. For instance, water that flows through limestone or gypsum dissolves calcium, carbonate, and sulphate, resulting in high levels of total dissolved solids.

Conductivity is a measure of the capacity of water to pass an electrical current and is affected by the presence of dissolved solids. As the level of TDS rises, the conductivity will also increase. Conductivity changes may indicate contamination. For instance, contamination of a water supply with sewage can raise the conductivity because of the presence of chloride, phosphate, and nitrate. Intensive use of fertilizers will have similar consequences.

Conductivity also increases with water temperature, so measurements must be presented in terms standardised at either 20 or 25 °C. Normally the measuring devices used in the field automatically make this conversion. Conductivity differences, like temperature variations, may indicate zones of pollution, mixture or infiltration. Surface-water conductivities are normally below 1 500  $\mu\text{S}/\text{cm}$ . In practice, acceptance problems for consumers appear above 1 500  $\mu\text{S}/\text{cm}$  (Table 4.X), but this factor depends a lot on the habits of the population concerned (the value of 1.5 g/l of TDS, which is equivalent to around 2 000  $\mu\text{S}/\text{cm}$ , is the drinking-water standard in France). Conductivity is measured in micro-siemens per centimetre ( $\mu\text{S}/\text{cm}$ ), and TDS in milligrams per litre. The relation between the two parameters is not linear.

Analysis should be done *in situ* with an electrical-conductivity meter.

*WHO recommendation: <1000 mg/l (~1400  $\mu\text{S}/\text{cm}$ ).*

### 3.3.5 DISSOLVED OXYGEN

Dissolved oxygen is affected by the presence of organic matter. Water absorbs oxygen to the point where partial pressure in air and water are in equilibrium. The solubility of oxygen in water depends on atmospheric pressure (and therefore on altitude), and on the temperature and mineralisation of the water: saturation with  $\text{O}_2$  decreases as temperature and altitude increase.

This parameter is used essentially for surface water. At sea level, at 20 °C, the concentration of oxygen in equilibrium with atmospheric pressure is 8.8 mg/l of  $\text{O}_2$ , or 100% saturation. Highly aerated water (e.g. in mountain streams) is generally supersaturated with oxygen, whereas water charged with organic matter degradable by micro-organisms is sub-saturated. A significant presence of organic matter in a water body, for example, allows micro-organisms to develop and consume the oxygen. Dissolved oxygen is therefore a useful parameter in the biological diagnosis of the aquatic environment.

Analyses should be done *in-situ*.

### 3.3.6 HARDNESS

Water hardness is created by dissolved calcium and magnesium, and is commonly expressed in mg/l CaCO<sub>3</sub>, or degrees of hardness.

$$1 \text{ French degree of hardness (TH)} = 10.3 \text{ mg/l CaCO}_3$$

Hardness is never a problem for human consumption, but high hardness may lead to encrustation of pipes, and low hardness (soft) waters may be corrosive.

*AEP standard lower limit 15 TH (155 mg/l CaCO<sub>3</sub>).*

*WHO recommendation: 100 to 300 mg/l.*

### 3.3.7 TEMPERATURE

The variations in water temperature in an environment provide indications regarding the origin and flow of the water. Water temperature is usually linked with other parameters, especially conductivity and pH (Box 4.4).

*Note.* – Analysis should be done *in situ* with a thermometer.

#### Box 4.4

Groundwater temperature.

##### *Temperature gradients*

It is generally considered that the geothermal temperature gradient is 1 °C per 33 m. This means that the deeper the groundwater is, the hotter it is.

Generally, the following classification can be established:

- depth between 2 and 5 m: zone of daily temperature variation;
- depth between 15 and 40 m: zone of annual temperature variation;
- depth greater than 40 m: constant temperature zone.

##### *Classification*

Particular causes, such as volcanic or thermal effects, have a significant influence on water temperature. There are three types of water source, depending on the difference between the average annual temperature of water and air:

- $t_{\text{water}} > 4 \text{ °C}$  more than  $t_{\text{air}}$  – thermal source;
- $t_{\text{water}} = t_{\text{air}}$  – normal source;
- $t_{\text{water}} > 4 \text{ °C}$  less than  $t_{\text{air}}$  – hypothermal source.

### 3.3.8 TURBIDITY

Turbidity characterises a cloudy condition in water caused by particles in suspension (organic residues, clays, microscopic organisms etc.). Problems for users caused by turbidity are related to acceptance. High turbidity allows micro-organisms to become fixed (adsorption) to particles in suspension: the bacteriological quality of turbid water is therefore suspect as strong turbidity can also protect micro-organisms fixed on particles from disinfection.

Turbidity is a major constraint for chlorination, as pathogens associated with particles are protected from oxidation. Another concern is the formation of organochlorides that are toxic. Sphere recommends turbidity below 5 NTU to enable effective chlorination.

Analysis to be done *in situ* (recommended) with a turbidity meter:

Units: 1 NTU (Nephelometric turbidity unit) = 1 JTU (Jackson TU) = 1 FTU (Formazin TU).

*WHO recommendation: <5 NTU and <0.1 NTU for effective disinfection.*

## 3.4 Major ions

The mineral content of most kinds of water is dominated by several elements, commonly called major ions. These elements are in general not linked to public health problems (except nitrate, see Table 4.IV). Values from the French standards (AEP) are provided here, as most of the major ions are not covered by WHO guidelines.

*Cations (positive charge):* calcium ( $\text{Ca}^{2+}$ ), magnesium ( $\text{Mg}^{2+}$ ), sodium ( $\text{Na}^+$ ), and potassium ( $\text{K}^+$ ), iron ( $\text{Fe}^{2+}$ ,  $\text{Fe}^{3+}$ ), manganese ( $\text{Mn}^{2+}$ ), ammonium ( $\text{NH}_4^+$ )

*Anions (negative charge):* chloride ( $\text{Cl}^-$ ), sulphate ( $\text{SO}_4^{2-}$ ), nitrate ( $\text{NO}_3^-$ ), nitrite ( $\text{NO}_2^-$ ), phosphate ( $\text{PO}_4^{3-}$ )

### 3.4.1 CALCIUM AND MAGNESIUM

Calcium  $\text{Ca}^{2+}$  and magnesium  $\text{Mg}^{2+}$  are present in crystalline and sedimentary rocks (calcite ( $\text{CaCO}_3$ ), dolomite ( $\text{CaMgCO}_3$ ), magnesite ( $\text{MgCO}_3$ ), gypsum ( $\text{CaSO}_4$ ), apatite ( $\text{Ca}_5(\text{PO}_4)_3$ ) and fluorite ( $\text{CaF}_2$ ) plus sandstone and detrital rocks with carbonated cement): they are very soluble substances, present in most types of water. Their concentration and the Ca/Mg ratio provide information about the origin of the water and the nature of the reservoir. The calcium ion is sensitive to base-exchange phenomena. Total hardness is the concentration of  $\text{Ca}^{2+}$  and  $\text{Mg}^{2+}$ . Carbonated hardness is the concentration of bicarbonate/carbonate ( $\text{HCO}_3^-$ ,  $\text{CO}_3^{2-}$ ).

*Due to its laxative effect, the French AEP standard upper limit for Mg is 50 mg/l. No AEP standard exists for Ca.*

### 3.4.2 CHLORIDES

The  $\text{Cl}^-$  ion is present in small quantities on Earth. The main source of chloride in water is solution of sedimentary rocks deposited in a marine environment, which have not been completely leached, and evaporites. Ingress of seawater (where  $\text{Cl}^-$  is present in great quantities) and evaporation phenomena in endoreic basins are also possible sources of chlorides (the smaller the distance from the sea, the more significant the contribution made by precipitation). Human contributions (e.g. from urine) are minor.

*AEP standard upper limit is 200 mg/l.*

*WHO recommendation (taste): <250 mg/l.*

### 3.4.3 IRON

The presence of iron in groundwater has several origins: in the form of pyrites ( $\text{FeS}_2$ ), it is usually associated with sedimentary rocks deposited in a reducing environment (marls, clays) and metamorphic rocks. It is usually found in strong concentrations in the water of weathered bedrock. The following concentrations in groundwater are reported by ACF:

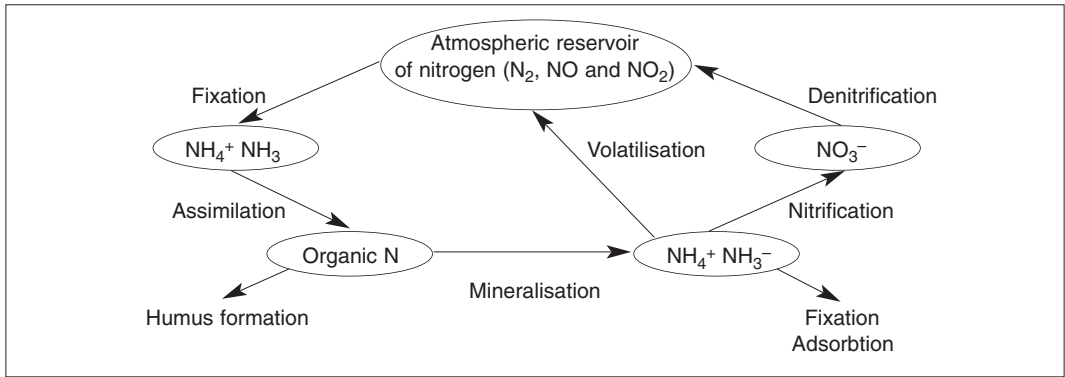
- sedimentary (Cambodia, 1998): 3–15 mg/l;
- bedrock (Uganda, 1996): 0.5–1.5 mg/l.

When present in reduced (ferrous) form ( $\text{Fe}^{2+}$  or  $\text{Fe(II)}$ ), iron is oxidised by atmospheric oxygen and precipitates in oxidised (ferric) form ( $\text{Fe}^{3+}$  or  $\text{Fe(III)}$ ) when water is pumped. This produces rust stains on the slabs of boreholes or wells, and users may not find the water acceptable, because it stains laundry and has a pronounced taste when consumed directly or in hot drinks.

Treatment to remove iron involves aeration of the water in order to oxidise the dissolved  $\text{Fe}^{2+}$  to  $\text{Fe}^{3+}$ , which then precipitates and can be removed by filtration.

*AEP standard upper limit is 0.2 mg/l Fe (in-situ analysis is recommended).*

*WHO recommendation: <0.3 mg/l.*



**Figure 4.5: The nitrogen cycle.**

#### 3.4.4 NITRATES AND NITROGEN COMPOUNDS

Nitrates ( $NO_3^-$ ) are part of the nitrogen cycle. The main nitrogen reservoir is the atmosphere. In natural water, nitrogen comes essentially from rain (1-3 mg/l) and from soil drainage.

Micro-organisms decompose organic matter present in the soil, and the mineral nitrogen thus produced is then transformed into nitrates by aerobic bacteria. This transformation, called nitrification, has two stages: nitritation, which produces nitrites ( $NO_2^-$ ), and nitratation, which transforms the nitrites into nitrates ( $NO_3^-$ ). If the conditions of the environment permit it, the nitrates are used as a source of energy by anaerobic bacteria, and transformed into gaseous nitrogen. Nitrates can also be adsorbed and become fixed on clays and humus.

The content of nitrates in soil, and later in water, is strongly linked to the quantity of organic matter and to environmental conditions. Contributions from human activities (use of nitrate fertilisers and manure) are therefore significant. Also, waste from sewage-treatment plants, latrines and septic tanks contribute organic matter capable of producing nitrates.

Nitrates and nitrites are considered dangerous to health. Nitrates ingested with water are reduced to nitrites in the intestines and become fixed to haemoglobin, thus decreasing oxygen transfer: this is known as methaemoglobinaemia, which affects children in particular (especially under 6 months).

The scale of nitrate concentration in water is very wide. Groundwater, with an environment that facilitates denitrification, can be nitrate free, whereas water 'polluted' by a significant contribution of organic matter, fertilisers or residual water may contain up to several hundreds of mg  $NO_3^-$  /litre.

*AEP standard upper limits are 50mg/l for  $NO_3^-$  and 0.1 mg/l for  $NO_2^-$ .*

*WHO guidelines (health related) are 50 mg/l (nitrate) and 3mg/l (nitrite).*

#### 3.4.5 PHOSPHATE

The main sources of phosphates are rock-leaching (carbonated contexts), faecal contamination, domestic pollution (detergents) and agricultural pollution. They are not toxic, but may lead to acceptance problems (taste and colour). They may also participate in germ proliferation (providing a nutrient salt) and are essentially useful as an indication of faecal contamination.

*AEP standard upper limit is 5 mg/l of  $P_2O_5$ .*

#### 3.4.6 SODIUM AND POTASSIUM

Sodium ( $Na^+$ ) is very abundant on Earth and occurs in crystalline and sedimentary rocks (sands, clays, evaporites). Halite, or rock-salt, is common salt ( $NaCl$ ), highly soluble in water. In



**Table 4.XI: Scale of sodium and potassium concentration.**

Context	Na <sup>+</sup> (mg/l)	K <sup>+</sup> (mg/l)
Groundwater in calcareous formations	1 < C < 4	0.3 < C < 3
Groundwater in crystalline formations	2 < C < 15	1 < C < 5
Seawater	C > 10 000	380

contrast, sodium does not normally occur in carbonated rocks (Table 4.XI). Clays can be saturated in Na<sup>+</sup> by the process of base exchange.

Potassium (K<sup>+</sup>) is quite abundant on Earth but not in water. It is easily adsorbed and recombined in the soil (particularly in clays). Its origin is crystalline rocks (but in minerals less susceptible to weathering than those that contain sodium), evaporites (sylvinite) and clays (Table 4.XI).

*AEP standards for sodium and potassium are 150 mg/l Na and 12 mg/l K.*

*WHO recommendation: <200 mg/l Na.*

### 3.4.7 SULPHATE AND HYDROGEN SULPHIDE

The natural origins of sulphate are rainwater and solutions of sedimentary evaporitic rocks, particularly gypsum (CaSO<sub>4</sub>), but also pyrites (FeS<sub>2</sub>) and, more rarely, igneous rocks (galenite, blende, pyrite). Human origins are mainly the use of chemical fertilisers and detergents. In general, the presence of sulphate in non-polluted natural water indicates the presence of gypsum or pyrites. In anaerobic conditions, sulphate is transformed by bacteria into hydrogen sulphide that is toxic and corrosive. Presence of sulphur in waters may lead to acceptance problems. Hydrogen sulphide (H<sub>2</sub>S) is a gas recognisable by its rotten egg smell at low concentrations. In higher doses, it becomes odourless and very dangerous if inhaled, causing frequent fatal accidents among sewer workers and possible problems in wells (Laos, ACF 1996) when gypsum is present.

*AEP standard upper limit is 250 mg/l SO<sub>4</sub>.*

*WHO recommendation: <250 mg/l for SO<sub>4</sub>.*

## 3.5 Trace-elements and toxic minerals

### 3.5.1 ARSENIC

Natural arsenic is mainly found in recent sedimentary contexts associated with large deltas (Burkina Faso, Cambodia, India, Bangladesh, Nepal, Vietnam, Zimbabwe). Other sources of arsenic are insecticides and chemical industries. Arsenic is a cumulative poison (causing skin cancers, liver cancers, leukaemia). It exists in water as the reduced As(III) form, which is free and toxic, or the oxidised As(V) form, which is less soluble and not toxic.

The presence of As is mainly in groundwaters: in the Cambodian Mekong alluvial basin, the highest concentrations in the aquifer are between 20 and 70m of depth: the upper layers of the aquifers present less free arsenic (oxidation), as well as the deep layers (precipitation). This vertical variability depends on both geological and hydrological conditions, but must be checked to find alternative water resources for long-term projects.

Arsenic concentrations may vary with seasonal events (floods, dry season) and also presents a huge geographical variability (in the same village, some boreholes may be contaminated and others not). The diseases caused by arsenic are generally linked to 10 to 15 years of water consumption.

*WHO guideline value is 0.01 mg/l maximum (some national standards may differ a lot, e.g. Cambodia: 0.05 mg/l). In-situ analysis is recommended.*



### 3.5.2 CHLORINE

Chlorine is a water-disinfection product. Laboratory tests show that chlorine ingestion corresponding to a concentration of 5 mg/l over 2 years does not cause health problems; above this threshold, there is no evidence as yet but WHO proposes a health-related guideline. Chlorine taste threshold: 0.3-0.6 mg/l; odour threshold: 2 mg/l.

*WHO guideline value: 5 mg/l.*

### 3.5.3 FLUORIDE

The main sources of fluoride in groundwater are sedimentary rocks (for example, fluoroapatite from phosphate basins), but also igneous rocks (granites) and veins. Thermal areas are also frequently involved. Rock-groundwater contact time and chemical interactions determine the concentration of free F<sup>-</sup>. Even though these concentrations are extremely variable, they can reach 5 to 8 mg/l in sedimentary basins (Senegal, Travi).

Fluoride is recognised as an essential element for the prevention of tooth decay (fluoride toothpaste). However, regular ingestion of water with a fluoride concentration greater than 1.5mg/l can cause problems such as bone and dental fluorosis (brown colouring of the teeth which can lead to their loss): children are particularly vulnerable to this problem.

*WHO guideline value is 1.5 mg/l maximum of fluoride (F<sup>-</sup>).*

### 3.5.4 LEAD

Lead is frequent in rocks (galena) and in the chemical industry (explosives), and is a cumulative poison, causing neuropsychological disorders and cardio-vascular diseases. It can be measured with a colorimeter.

*The WHO guideline value is 0.01mg/l maximum. In-situ analysis is recommended.*

### 3.5.5 MANGANESE

Manganese in groundwater has mainly natural (pyrite) or agricultural (soil-texture improvers) origins. Presence in drinking water may create acceptance problems (dark-coloured water and taste). Above 0.1 mg/l, manganese causes staining problems (as does iron), and a black deposit can be formed in water pipes. Certain organisms concentrate manganese, which leads to turbidity and taste problems.

*AEP standard upper limit is 0.05 mg/l Mn. In-situ analyses are recommended.*

*WHO guideline 2003 (health): 0.4 mg/l.*

### 3.5.6 OTHER ELEMENTS

Other elements, like cadmium, selenium, bromine etc. may present a serious risk for human health. They are extremely time-consuming and expensive to measure and are only exceptionally tested for in most situations where ACF works.

## 3.6 Biological indices

Some relevant information that is not picked up by chemical analyses can be picked up by using biological indices that characterise an aquatic environment according to the organisms found.

Each living organism has some particular environmental requirement. Aquatic environments are thus colonised by animal and plant populations with structures corresponding to a certain balance.

If the environment is disrupted, a modification of the structure of those populations can be observed.

- Vertebrates (frogs and toads) prefer cleaner water and cannot survive in water depleted of oxygen.
- Massive fish death indicates severe depletion of oxygen (heavy organic load) or toxic pollution.
- A large number of plants and algae (often of a murky green colour) indicates a high nutrient level in water: pollutants such as fertilisers, sewage, industrial wastes.
- Water looking like ‘pea soup’ (light green, murky) contains blue-green algae that secrete substances that make water unfit for drinking.
- The presence of sewage fungus indicates heavy organic pollution.

## 4 Water analysis

Properly-conducted water analysis involves three stages: sampling, analysis and presentation of results/interpretation.

### 4.1 Sampling

#### 4.1.1 METHODOLOGY

Sampling is vital, because it affects the significance of the analysis. Strict procedures should be used, that provide representative samples of what is being analysed. The protocol for sampling will depend on the type of analysis. See Section 4.1.1 and Annex 7C for more details.

#### 4.1.2 CONTAINER MATERIALS

Polyethylene is recommended for all kinds of sampling. Although it is relatively porous to gases, and glass may be preferred for sampling and preservation of highly gaseous water, it is less fragile than glass, and gas diffusion is slow.

Polyvinyl chloride, which is used to make sterile disposable sampling bags, has the disadvantage of liberating chlorine if the bags are exposed to light for too long. Sterile bags are fragile and must be protected during transport of samples.

Glass containers are suitable for most determinations. Brown bottles should be used as they reduce photosensitive reactions.

#### 4.1.3 MODIFICATIONS AND PRESERVATION OF THE SAMPLES

The fact of taking a water sample and removing it from its natural environment inevitably modifies it, to a greater or lesser extent, depending on the parameters of concern. Some of them can be considered stable over the timescale in which we work, but others change very quickly (e.g. oxidation processes, chemical changes): temperature, conductivity, pH, dissolved gas, nitrates, sulphates, arsenic and toxic minerals change quickly.

A variation in temperature causes a modification in the equilibrium constants of elements in solution. In order to establish new equilibriums at the new temperature, several chemical reactions occur, which may cause the precipitation of salts, favour solution of gas etc. Nonetheless, a low temperature (around 4°C) slows reactions down sufficiently.

Contact with the air and decompression can also be responsible for changes in solution.

Each type of ion contributes to the total conductivity of a solution, and any modification of the chemical equilibriums, and therefore of the relative proportions of the dissolved elements, causes a change in conductivity. The higher the temperature of the water, the more dissolved CO<sub>2</sub> tends to

**Table 4.XII: Sample preservation.**

Determination	Sample Container	Preservative	Filtration required?	Max. time before analysis
Acidity or alkalinity	Plastic or Glass	None	Yes	14 days
BOD	Plastic or Glass	None	No	6 hours
Chloride	Glass	None	Yes	28 days
Chlorine (residual)	Plastic or Glass	None	No	<i>In situ</i>
Conductivity, pH	Glass	None	No	28 days / <i>in situ</i>
Fluoride	Plastic	None	Yes	28 days
Hardness	Glass	HNO <sub>3</sub> to pH <2	Yes	6 months
Metals, trace-elements	Plastic	HNO <sub>3</sub> to pH <2	Yes	6 months
Ammonia nitrogen	Glass	H <sub>2</sub> SO <sub>4</sub> to pH <2	Yes	28 days
Nitrate & nitrite nitrogen	Glass	H <sub>2</sub> SO <sub>4</sub> to pH <2	Yes	28 days
Nitrate & nitrite nitrogen	Glass	None	Yes	48 hours
Phosphate, sulphate	Glass	None	Yes	28 days
Sulphide	Glass	None	Yes	7 days

escape. A loss of CO<sub>2</sub> provokes precipitation of carbonate, which modifies the pH. Nitrates and sulphates can be reduced by bacterial activity after the sampling stage.

In adverse conditions, changes can occur in just a few hours. Preservatives prevent these changes, but are sometimes not practical logistically in the field (e.g. concentrated acid). Table 4.XII lists the sample containers and preservatives to be used for the main parameters to be determined.

As a general rule, it is best to analyse the samples as soon as possible after collection. Specific recommendations for field situations are given in Section 4.1.4.

#### 4.1.4 SPECIFIC RECOMMENDATIONS

##### 4.1.4.1 Samples for bacteriological analysis and BOD

Samples for bacteriological analyses and BOD must always be taken and preserved in a sterile container. The use of sterile disposable bags is advisable. Biological analyses are carried out 6 hours maximum after taking the samples if they are kept cool (4°C), or within 1 hour if kept at room temperature, in the dark. Even if it is possible to conduct biological analysis on site (e.g. with a DelAgua kit), the use of a mini-laboratory is strongly recommended.

Specific recommendations for sampling for bacteriological analysis are as follows:

- Use extremely clean containers for sampling (see Section 4.1.2), wash your hands with soap.
- Rinse the container several times with the water to be analysed:
  - for a pump, work the pump for enough time to renew and rinse the inlet and outlet pipes, and the pump body;
  - for a tap, clean the tap (with alcohol or soap), let the tap run fully for about 30 seconds, flame it with a pad soaked in alcohol, let it run again for 30 seconds.
- Always fill sample containers to the brim and stopper them so that no air is left above the sample, since it could favour the emission of some gas dissolved in the water, which would modify the chemical balance in the solution.
- Mark the bottle (or sterile bag).
- Systematically take three samples for bacteriological analysis (due to high variability in the results of this analysis).
- Record in a notebook.
- Keep the sample in cool box (4°C, 6 hours maximum before analysis).

#### 4.1.4.2 Chemical parameters

Temperature, pH, conductivity, alkalinity, free residual chlorine and dissolved oxygen must be systematically measured *in situ*.

If complex preparation is required for transport of samples for carrying out certain chemical tests in a laboratory (for instance, for As, metals, toxic minerals and trace-elements), these tests should be done *in situ*, to avoid this complication.

The analysis must be carried out as soon as possible, not more than 72 h after taking the samples. If this is not possible, the samples must be prepared for preservation (Table 4.XII); the sample is passed through a 0.45 µm filter (the bacteriological analysis filtration system may be used), and then acidified until a pH close to 2 is obtained (see Table 4.XII). The samples can be kept for 3 months at room temperature or, even better, at around 4°C.

## 4.2 Methods of analysis

### 4.2.1 METHODS

#### 4.2.1.1 Bacteriological analysis

Bacteriological analysis mainly involves determining the presence of *faecal coliforms*, as an indication of faecal contamination (see Section 3.2.2).

The method most commonly used in the field is filtration through a membrane and development of bacteria colonies in a favourable environment. It is relatively easy to carry out in the field and consists of:

- Filtering a known volume of water through a porous membrane, designed to retain bacteria (0.45 µm).
- Putting this membrane under conditions that allow the development of thermotolerant (faecal) coliforms but not other bacteria: 16-24 h incubation at 44°C in a favourable nutritional environment for thermotolerant coliforms multiplication. Incubation at 37°C is used for total coliforms identification.
- After 16-24 h, the colonies formed by the bacteria are visible to the naked eye, with a specific colour (Figure 4.6), and can be counted. The results are expressed in number of colonies per 100 ml of water sample.

The timing and temperature for incubation, as well as the colour developed by each type of bacteria colony, is closely linked to the type of culture medium, that can be more or less selective. Refer to the instructions provided with each product used. The characteristics of the most common culture media are presented in Table 4.XIII.

**Table 4.XIII: Characteristics of common culture media used to detect coliforms by incubation.**

Product	Resuscitation process	Incubation process	Detection	
			<i>E. coli</i>	Faecal coliforms
Lauryl sulphate broth	Room temperature 3 to 4 hours	44 °C +/- 0.5 °C 16–18 hours	Yellow	
Millipore MFC Broth	35 °C +/- 0.5 °C 4 hours	44.5 °C +/- 0.2 °C 14–16 hours	Blue	
Coliscan – MF Broth	Room temperature 20-30 min	35 °C +/- 0.5 °C 18-24 hours	Black	Blue-grey, red-pink, cream
Coliscan Easygel	Room temperature 20-30 min	35 °C +/- 0.5 °C 24 hours	Purple-black	Light blue, blue green, white

**Figure 4.6: Example of a bacteriological analysis result.**

*Note.* – Bacteriological analyses are commonly carried out in the field, but results are often highly variable and correct analysis requires sterile conditions. Therefore, three samples per site must be analysed.

*Bacteriological testing equipment*

The DelAgua kit (see Annex 7D) has become widespread as incubator for bacteriological analyses. ACF uses a modified DelAgua kit (with an integrated 220 V and 12 V supply instead of an internal battery).

The culture medium used is the ready-to-use Millipore MFC (membrane faecal coliform) broth, which develops a specific colour with faecal coliforms. ACF also uses disposable plastic sachets for sterile water sampling.

Many countries (including India and Pakistan) produce precise incubators (with temperature control and electronic alarm), with high capacity (about 100 petri dishes) and competitive prices.

*Refrigerator and cool boxes*

Essential for the conservation of both samples and culture media.

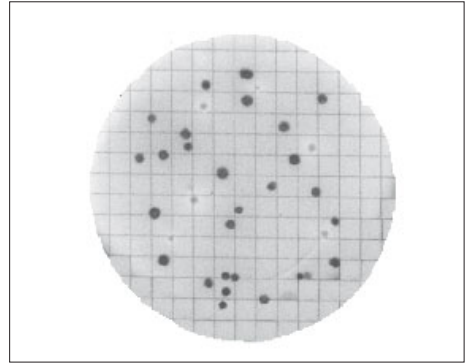
**4.2.1.2 Chemical analysis**

There are different analysis techniques for chemicals (see Table 4.XIV), each with its own purpose.

Colorimetric or visual interpretation techniques (e.g. pH strips) are not very accurate, but are appropriate for situations where speed and simplicity are more important than complete accuracy.

**Table 4.XIV: On-site methods and materials for water analysis.**

Parameter	Measurement by portable electrochemical probe	Photometry (spectrometry)	Titration or colorimetry
pH	X		
Conductivity	X		
Chlorides	X	X	X
Alkalinity			X
Phosphates	X	X	X
Sulphates		X	X
Nitrates/nitrites	nitrate		
Ammonia	X	X	X
Calcium	X	X	X
Magnesium	X	X	X
Sodium	X		
Potassium	X	X	X
Hardness		X	X
Iron		X	X
Manganese		X	X
Fluorides	X	X	
Silica		X	X
Aluminium			X
Chlorine			X
Hydrogen sulphide		X	X
Oxygen	X		
Oxidability			X



Analyses with specific electrochemical probes are simple, but the probes are fragile, have a limited life ( $\approx 1$  year), and are expensive.

In order to obtain accurate results for major ions, it is advisable to contact a laboratory (or a university). This can also be done to verify analyses carried out with on-site equipment (validation of a specific health risk identified with a colorimeter or photometer, e.g. in the case of significant arsenic or fluoride presence).

#### *Basic physical and chemical testing equipment*

*Pool tester, pocket kits:* colorimetric method, where tablets are dissolved in the sample and the resulting colour read on a colour scale (major elements).

*Electronic stick meters:* small portable electronic equipment that gives a digital reading when the electrode is submerged. Needs regular calibration (pH, conductivity). This equipment is cheap, very easy to use and robust but its precision is generally limited.

*Turbidity tube:* the tube is filled, then water is poured out until the reference circle marked on the bottom of the tube appears.

*Comparator with disks:* tablets are dissolved in a small tube. The sample in the tube is viewed in the comparator against a graded colour on an interchangeable disk (pH).

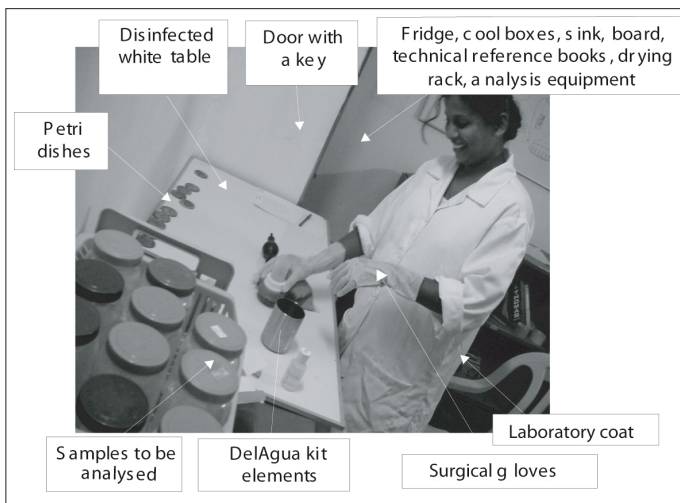
*Photometer:* colorimetric method. Electronic instrument with a digital display. Tablets are dissolved in the sample and the concentration of the colour is read electronically. The instrument uses blank sample and calibration (F, As).

*Note.* – Field analysis equipment (pH meter, GPS) can be seen as dangerous equipment in specific contexts. Staff should adapt their behaviour and be careful in handling this material, especially in areas of conflict.

#### 4.2.2 THE USE OF A MINI-LAB

A mini-lab can be a small room (3 m x 3 m) containing all the equipment required for chemical and bacteriological analyses. It can be attached to an existing facility in the case of long-term programmes. Its use is for all types of off-site analysis, and for safe keeping of chemical products, equipment and samples. It is especially useful for microbiological analyses, which require care and the cleanest environment practical. It contains:

- a refrigerator (for samples and culture media);
- a working surface, such as a white-topped bench or table, that is easy to disinfect with alcohol;



**Figure 4.7: Mini lab for biological analysis (ACF, Sri Lanka, 2000).**

- a sink and draining rack;
- all the necessary technical documentation;
- special medical / laboratory dishes;
- stove and saucepans for sterilisation.

The operator must always wear a laboratory coat and surgical gloves for microbiological analyses. They must remove their shoes and replace them with plastic sandals before entering the mini-lab. The mini-lab is regularly disinfected.

*Note.* – In some countries, it is not appropriate for a woman to work with a man in a closed room.

## 4.3 Presentation of results and interpretation

### 4.3.1 PRESENTATION OF RESULTS

It is essential to record and keep the results of the analysis (mainly if a sanitary risk is identified). Normally, one sheet per site analysed is recommended (see Annex 7E). The information to be reported includes:

- general location (plus GPS data);
- date of sampling / analysis;
- type of site (river, borehole, well, reservoir);
- the person in charge of sampling / analysis;
- the full analysis table;
- comments on the quality of the water and the site.

The full analysis table contains three columns (three samples are taken at each site, systematically for bacteriological analyses, ideally for other elements as well). Each result is given with the mean of the three samples, the maximum value and the standard deviation observed. If the three

**Table 4.XV: Water analysis modalities and their interpretation.**

Purpose of the analysis (programme steps)	1) Regional study of quality of the water resource (feasibility study)	2) Analysis of water quality at the water point (validation)
Location	Region / village	Water point (spring, borehole, well or distribution network)
Timing	During selection of the programme area	During work and after completion of technical work, before handing over
Parameters to be checked	Chemical parameters, toxic minerals, physicochemical characteristics (conductivity, pH etc.) Parallel study on morbidity data must be done	Chemical (toxic minerals) and physicochemical characteristics, microbiological quality
Reporting	Mapping (GPS)	Chemical profile included in contractual handover documents
Body responsible	Implementing agency	Implementing
Interpretation		
Implications for the programme	Validation of the water resource selection; if not: – Choice and design of water treatment – Selection of an alternative type of resource – Application of the precaution principle	Validation of the water point; if not: – Choice and design of water treatment – Abandoning the source & finding another area or kind of water source

samples do not give reasonably homogeneous results, the whole analysis (including sampling) has to be done again, because the variation is probably due to non-representative sampling or a mistake during analysis. A good practice is to register and keep the filtration membranes in a file (in the case of bacteriological analysis), to come back if needed to check suspicious results.

#### 4.3.2 REPRESENTATIVENESS

The analysis is done on water sampled at a specific moment, in a specific place and according to a specific methodology. The question is “How representative is the sample of the source or the water point to be analysed?”. It is important to define clearly what the analysis means and what are the factors that can affect representativeness.

Spatial or temporal variability of chemicals, for instance, can indicate an absence of mineral toxic risks during the dry season; however, during the rainy season, leaching can cause the spread of chemicals. Poor sampling can also reduce the real representativeness of an analysis. See Box 4.5 for two examples of specific representativeness of water analysis.

#### 4.3.3 INTERPRETATION

The interpretation of water-quality analysis can also be questioned in a larger sense; What are we analysing? Why? When and with which frequency? What is the general purpose of the analysis? What are the standards chosen to characterise the water quality? Are the water-quality standards selected for the programme realistic in comparison with the water consumed by the population as a whole? etc.

All these questions show that a water analysis is not representative in itself, but rather it must be read with a critical sense and properly used. An overview of water-analysis interpretation is suggested in Table 4.XV.

3) Monitoring of water quality at the water-delivery point

At the point of delivery of water to the house

On a regular basis after handing over

Microbiological water quality  
Technical and sanitary inspection of the water point must be done in parallel

Water analysis standard format  
Sanitary inspection form

4) Monitoring of water quality between collection and household

In recipients used for water transport, storage and consumption

On a regular basis, after being sure that people use the water point/delivery system

Microbiological water quality  
Hygiene inspection of the recipient used for water transport, storage and consumption must be done in parallel

Water analysis standard format  
Sanitary inspection form

agency, water-point committee, government institutions, local NGOs, private companies

Comparison with relevant standards (adapted to context)

Validation of correct functioning; if not:  
– Repair of water-supply equipment  
– Definition (or adjustment) of treatment process (temporary or permanent)  
– Restructuring of the water point committee  
– Redefinition of maintenance activities

Validation of the hygiene practices; if not:  
– Design of a specific hygiene-promotion programme  
– Hygien kits distribution



#### Box 4.5

##### Examples of specific representativeness.

###### *Wells and boreholes*

An analysis of water that has been stagnant for a long time is not representative of the aquifer, but of the well, at a specific time: the water may also have been affected by casing or pipe material constituents (metal) and exterior elements (pollution, rain etc.). To obtain an average sample of the horizon involved, it is advisable to pump for long enough to renew the water contained in the pipes or tanks. If the work covers several aquifer horizons, the sample will be a mixture of water from different levels, with proportions directly linked to the transmissivity of different levels. To obtain point samples at various depths, it is possible to use ballasted containers, provided with a closing system operated from the surface. To limit water mixing while taking the sample, it is advisable to use sample collectors with a diameter much smaller than that of the borehole, and also to operate them very slowly. Lowering sample collectors in the open position allows them to be rinsed as they go down.

###### *Surface water*

Samples are taken avoiding boundary effects (e.g. for a river, oxygenation near the surface, suspension of solid matter near the bottom, stagnant water near the banks etc.) as much as possible. It may be necessary to make up an 'average' sample by mixing several samples taken in different sections of a stream, to obtain a better understanding of the average chemistry of the water in a given section. Surface waters are often subject to extreme spatial and temporal variability.

Water-analysis interpretation (selection of parameters and standards) will depend mostly on the context. Section 1.2 explains how water quality is considered in emergency or long term projects. It will also depend on the implementation phase of the project (see Section 1.2. and Table 4.XV).

Faecal contamination indicates a risk of water contamination by pathogens (see Section 2.3.1: low risk, significant risk, high risk). But the interpretation does not concern only the sanitary risk: it can also be used to identify technical problems in a water-supply system.

– *Open wells*: faecal contamination can be linked to the use of a dirty bucket or rope. Regular disinfection and hygiene promotion can reduce the risk of contamination.

– *Boreholes or wells equipped with pumps*: faecal contamination is totally unacceptable even if the contamination is low and doesn't present a significant sanitary risk. This contamination often indicates a failure in the installation that allows the contamination of the source by infiltration (e.g. incorrect sealing of headworks), or groundwater contamination (e.g. from a nearby latrine). In such cases, rehabilitation of the installation must be done, or the source of contamination must be removed.

– *Distribution networks*: faecal contamination indicates a technical failure in the system: the pipelines (e.g. buried pipes are cracked or corroded, allowing contaminated water to enter), the treatment plant or the intake (contamination of the source). In all such cases, the system must be inspected in order to identify the source of contamination.

# Groundwater prospecting

## A HYDRO-GEOPHYSICAL STUDIES

<b>1</b>	<b>Questions facing the prospector</b>	131	<i>4.3.1 Principle</i>	160
<b>2</b>	<b>Preliminary actions</b>	132	<i>4.3.2 Measurements</i>	160
2.1	Available information	132	<i>4.3.3 The VLF method</i>	160
2.2	Cartography	133	<i>4.3.4 The Slingram method</i>	165
2.3	Satellite images	134	<i>4.3.5 TDEM soundings</i>	166
2.4	Photo-interpretation	134	<b>4.4 Magnetic Resonance Sounding</b>	168
<b>3</b>	<b>Field survey</b>	135	<i>4.4.1 Principle of the method</i>	168
3.1	The preliminary visit	135	<i>4.4.2 Performing measurements</i>	170
3.2	Technical meetings	136	<i>4.4.3 Interpretation</i>	171
3.3	Additional investigations	136	<b>5 Prospecting procedures</b>	177
<b>4</b>	<b>Hydro-geophysical methods</b>	136	5.1 Exploration boreholes	177
4.1	Introduction to the methods	137	5.2 Assessment of the resource	177
4.1.1	<i>The principle</i>	137	5.3 Storage of results and analytical tools	177
4.1.2	<i>The choice of methods</i>	137	5.4 Prospecting procedures	178
4.1.3	<i>Geophysical procedures</i>	140	<i>5.4.1 Hydrogeological questions</i>	178
4.2	The Electrical Resistivity method	140	<i>5.4.2 The choice of geophysical method(s)</i>	180
4.2.1	<i>The principle</i>	140	<i>5.4.3 Applications of the geophysical methods</i>	181
4.2.2	<i>Measurements</i>	142	<i>5.4.4 Proposing a hydro-geophysical procedure</i>	185
4.2.3	<i>The method in practice</i>	143		
4.3	Electromagnetic methods	160		

The success of a borehole or well depends to a great extent on how and where it is constructed.

Prospecting for groundwater is the process that leads to an understanding of the nature and the dynamics of the water resources. This process is a series of steps, carried out using various tools, enabling the prospector to optimise the borehole or well and to estimate the useful life of the groundwater resources.

### 1 Questions facing the prospector

The principal questions to be considered by the “ACF prospector” are categorised below:

#### *Aquifer geometry*

- Estimation of the depths and surface area of the water-bearing zones.
- Determination of the capping-layer quality (clayey or permeable).
- Definition of the unconfined water static level.

#### *Water storage*

- Estimation of the quantity of water stored (drainage porosity or storage coefficient).
- Estimation of the water quality.

**Table 5.I: General prospecting procedure.**

Phases	Objectives	Principal tools
Preliminary study	To accept or reject groundwater as a supply for the population To determine the technical solutions needed to satisfy the local water requirements	Analysis of available data Maps Satellite images Field study
Construction study	To confirm the utility of the selected aquifer To decide on the precise siting of the borehole or well	Photo-interpretation Geology and geomorphology of the study area Geophysics Piezometry Hydrochemistry
<i>Construction of wells or boreholes</i>		
Evaluation of the resource	To simulate the behaviour of the borehole over time To estimate the quantity of water in the aquifer	Test pumping Piezometry Water balance Hydrodynamic modelling
Perfecting procedures	To evaluate the initial hypotheses in the light of results obtained	Use of all the tools shown to be useful

*Water flow characteristics*

- Estimation of the permeability coefficient.
- Estimation of the transmissivity and of a theoretical exploitable yield.

*Resource life*

- Estimation of the exploitation potential over various time scales.
- Estimation of the vulnerability of the resource in terms of its water quality.

*Equipping boreholes*

- Localisation of water-bearing zones before installing equipment.

The procedure for answering these questions is a series of steps or phases, which can be interrupted in the case of failure, and which can be carried out gradually (Table 5.I).

The prospecting procedure to use in a particular case depends on the hydrogeological context. It is therefore first of all necessary to identify the nature of the system in question, before being able to determine which research methods to apply and choose suitable investigation tools.

## 2 Preliminary actions

Whatever the geological context and the prospecting procedure envisaged, a few simple actions can be rapidly performed, enabling the selection or rejection of groundwater as a supply option. They can also help to identify which technical solutions should be adopted. The aim at this stage is to make a decision and draft a budget.

### 2.1 Available information

In certain urgent and complex situations, the study of the site should start with the collection, compilation and organisation of existing information. Such information may be available locally, or from national institutions, other NGOs and universities, and also at the international level, from the UN, universities, geological research centres etc.

The principal questions which can be answered in this way are summarised in Table 5.II.

**Table 5.II: Main preliminary questions.**

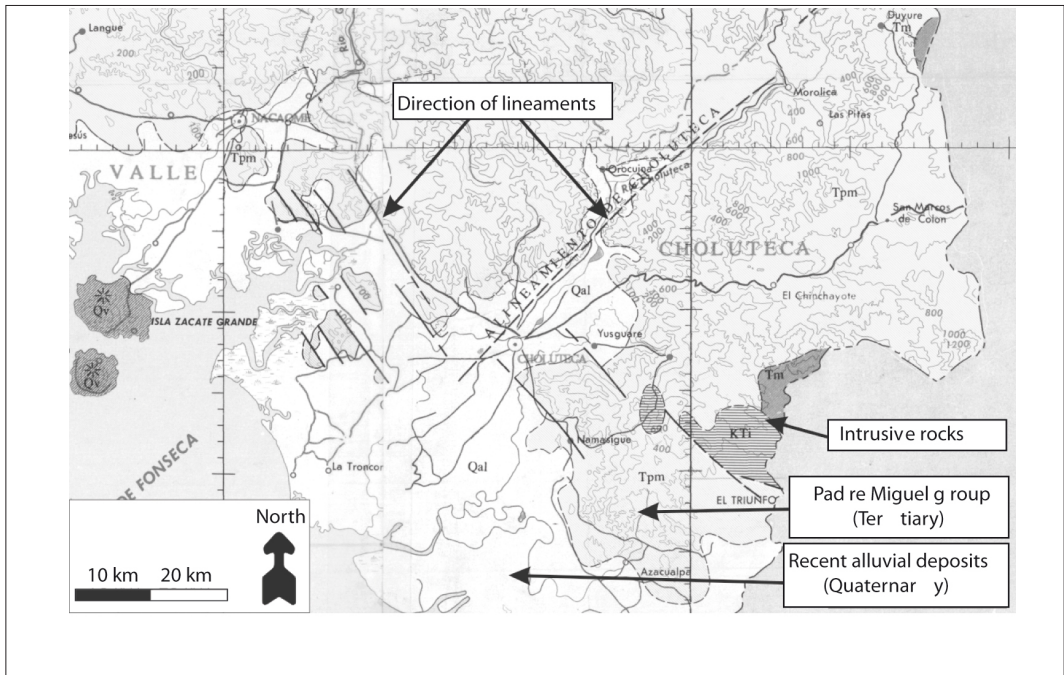
Type of geological formation	Alluvial, sedimentary basin, bedrock zone etc.
Climatic data	Average monthly rainfall and temperatures
Groundwater resource	Average depth, yield of existing installations
Possible technical solutions	Wells or boreholes Construction techniques Average depth and diameter Routine methods of siting and construction
Cost/resources	Technical Human Logistic

## 2.2 Cartography

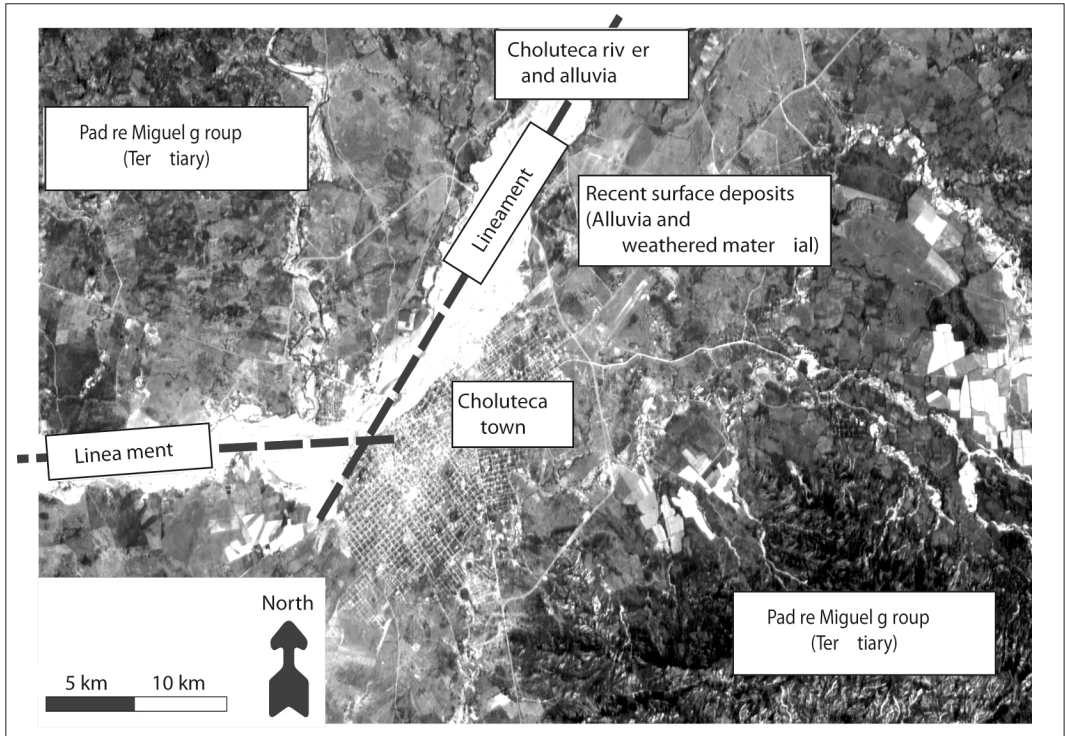
Topographical and geological maps indicate the main characteristics of the zone under study at the regional level, even if their scales are often too small to give a highly detailed picture.

Figure 5.1 shows an extract from a geological map of the Choluteca region of Honduras (from *Mapa Geologico de Honduras*, M.J. Kozuch, 1991) where ACF was planning a borehole-drilling programme. Despite its small scale (1:500 000) this map reveals:

- contact between non-consolidated sediments (quaternary) and consolidated volcanic rocks (tertiary);
- the principal directions of lineaments (N45° and N330°);
- the relief;
- the hydrographic network (on the topographic map of the region, the linear course of the river Choluteca also indicates a consolidated and fractured formation).



**Figure 5.1: Geological map of southern Honduras.**



**Figure 5.2:** Extract from a SPOT (KJ 615-323) image (30/11/1998) centred on the town of Choluteca, Honduras.

### 2.3 Satellite images

The analysis of satellite images is generally concerned with questions about vegetation, structural parameters and geomorphology. Figure 5.2 shows an extract of a SPOT image of the town of Choluteca in Honduras. The information it contains complements that obtained from the geological map (Figure 5.1):

- contrasts in the plant cover indicate different geological/pedological areas, humid zones and dryer zones (alluvia and recent capping, volcanic rocks in the Padre Miguel group);
- lineaments several kilometres long are clearly visible running across the hydrographic network (they are also shown on the topographic maps);
- the drainage networks (concentration of runoff water) and the zones of runoff (slopes) are clearly visible in the topography.

### 2.4 Photo-interpretation

The interpretation of aerial photos is based on the analysis of forms of relief which are identified directly, by stereoscopic imagery, or indirectly, by studying the hydrographic network and variations of the contrast levels in the photograph.

– *In a bedrock zone*, the most useful information is that concerning fracturing and weathering, which are signs of the probable presence of water.

- The hydrographic network is often superimposed on the fracture network: stereoscopic images of this network can thus yield structural information. Generally speaking, a dense, many-branched hydrographic network is the consequence of impermeable terrain. In a basement zone, this gene-



**Figure 5.3: Aerial photo, Marcelinot Champagnat, region of Choluteca, Honduras (ACF 2000).**

rally means that the erosion products are plentiful and clayey. On the other hand, a linear hydrographic pattern indicates a fractured zone, which may have suffered very little weathering.

- The lineaments are not always aligned with by the hydrographic network: they can also be found in terrain running across the relief or vegetation.

- The lineaments identified must be studied in the light of their direction: the best choice is those directions where the fractures are known to be open, or sometimes the intersection points of two lineaments (nodes).

- In bedrock areas, aerial photos can also be used to distinguish preferential infiltration zones (lowlands, *oued*) from draining zones (hydrographic network).

– *In non-consolidated, sedimentary zones*, the information required is different. The key points to identify are:

- the geological units, indicated by the vegetation and the relief;
- floodable and well-drained areas;
- the hydrographic network, whose previous pathways (paleochannels) are sometimes clearly visible: these are favourable sites for siting wells and boreholes.

Figure 5.3 shows a structural analysis performed using aerial photos of Marcelinot Champagnat Camp (in the north-east of the satellite image in Figure 5.2). The geological context is that of tertiary rhyolitic ignimbrites (Padre Miguel group) capped in the northern part of the photo by quaternary alluvia and erosion products (colluvia). The N45° lineament corresponds to a regional principal fracture direction marked on the geological map (Figure 5.1) and on the satellite image (Figure 5.2). The borehole which was drilled on this structure had an air-lift output of 82 m<sup>3</sup>/h for a total depth of 32 metres, whereas the previous boreholes drilled outside the fracture zones had much lower outputs for greater depths (6.5 and 3.5 m<sup>3</sup>/h for 55 and 96 metres depth respectively).

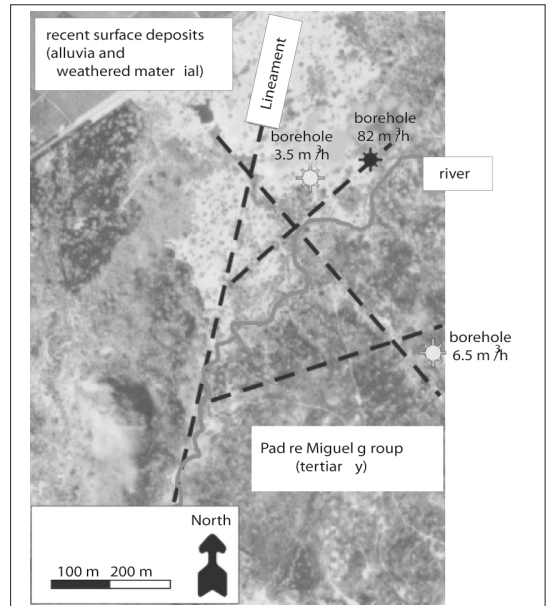
### 3 Field survey

All the analyses carried out in the office must be continued in the field. In practice, the process is iterative between data collection in the field and data analysis in the office.

#### 3.1 The preliminary visit

It is essential to visit the area and meet the authorities (traditional and/or administrative) and the local population. After introductions, the information needed to understand the situation is sought: this is done by observation, listening, questioning without suggesting the answers, reformulating questions etc. A range of factors need to be understood, including human and technical elements (see Chapter 2):

- the climatic context: rainfall and seasonal patterns of rainfall, temperature, wind etc.;



- the geological context: outcrops, tilts, directions of identified fractures, profiles observed in wells etc.;
- the geomorphological context: relief, hydrographic network, potential infiltration zones, floodable zones;
- the hydrogeological context: state of the existing water resources: cleanliness, durability, measurement of static and dynamic levels, and estimation of outputs, localisation of positive *and* negative wells/boreholes, water quality (conductivity measurements), ‘special’ observations such as the alignment of termite mounds in some direction, the association of certain trees with existing water points, the positions of the most productive water points in relation to the geomorphology, the hydrographic network etc.

The results of this preliminary visit can be summarised graphically on maps or digital satellite images (e.g. using a GIS programme).

### 3.2 Technical meetings

At this stage in the investigations, meetings should be held with businesses, regional and national technical departments and any other relevant organisations, in order to complement the information gathered during the preliminary visit: borehole reports, pumping tests, hydrochemistry etc.

Dialogue with the local population remains essential: the inhabitants of the zone have a certain amount of knowledge and are aware of what has already been tried and whether or not it worked.

### 3.3 Additional investigations

Once the potential aquifers have been identified, the next step is to determine in the field the exact sites at which to construct the wells or boreholes.

Existing structures must be visited systematically, in order to measure the total depths, the static and dynamic levels and the production (output:drawdown ratio). The measurement of the water’s conductivity at each site, and that of surface water, can indicate the degree of linkage between the groundwater zones (is there one large homogeneous aquifer, or several isolated systems?). The conductivity can also reveal any problem of excessive mineralisation of the water, or of salinity.

The topography and the plant cover can be used to identify zones of infiltration and run-off.

In bedrock zones, the sites selected by inspection of aerial photos should be visited, to verify the presence of lineaments. An alignment identified on a satellite image or photo may turn out to be a track or a trench, and thus without any particular water-bearing potential. In the field, all the signs which might confirm the presence of an anomaly should be observed: alignments of termite mounds or large trees, changes in vegetation, outcrops etc.

In alluvial zones, the groundwater-river interactions (supply/drainage/silting, should be estimated (see Chapter 3).

## 4 Hydro-geophysical methods

Geophysical methods can be applied to hydrogeology (hydro-geophysical methods). They may be useful at some stage in the hydrogeological procedure, to answer questions concerning the local geology. Such questions are specific to the context of the study, but they can be grouped as a function of aquifer typology and classed in two categories: the first concerns the aquifer geometry; the second concerns the parameters describing the storage and flow characteristics. Where the salinity of the groundwater may be an issue, the prospector may also wish to measure electrical conductivity.

From 2000 to 2003, ACF ran a research and development programme to appraise the aptitude of geophysical methods to characterise aquifers in the principal geological types (non-consolidated

formations, bedrock zones and carbonated rocks). This work included, notably, a study of the new “MRS” method, whose principal results are presented in this chapter (Vouillamoz, 2003).

## 4.1 Introduction to the methods

### *Notation used*

Direct Current method	DC method
Resistivity Profiling	RP
Vertical Electrical Sounding	VES
Electrical Resistivity Imagery	ERI
Spontaneous Potential	SP
Electromagnetic method	EM method
Very Low Frequency	VLF
Time Domain Electromagnetic	TDEM
Magnetic Resonance Sounding	MRS
Borehole Electrical Logging	BEL
Transmitter	Tx
Receiver	Rx

### 4.1.1 THE PRINCIPLE

Hydro-geophysical methods measure the spatial and temporal variations in the physical properties of underground rocks. The physical properties studied are influenced by the nature of the reservoir, the volume of empty space it encloses (its porosity) and the volume, the degree of saturation and quality of the water it contains.

– With all the traditional geophysical methods, the groundwater affects certain measured parameters, but it is never the only influencing factor. The physical quantities recorded by the geophysicist do not enable a direct determination of the presence of groundwater or its quality, but in favourable cases they help to consider the nature and the structure of any aquifers present.

– In comparison with traditional methods, Magnetic Resonance Sounding (MRS) can be classed as a *direct* geophysical method, because it measures a signal emitted by atomic nuclei present in each water molecule. The contribution of MRS to hydrogeology is thus the ability to measure directly a signal indicating the existence of groundwater.

Among the numerous geophysical methods used in hydrogeology, three have been selected by ACF on the basis of the particular requirements of humanitarian programmes:

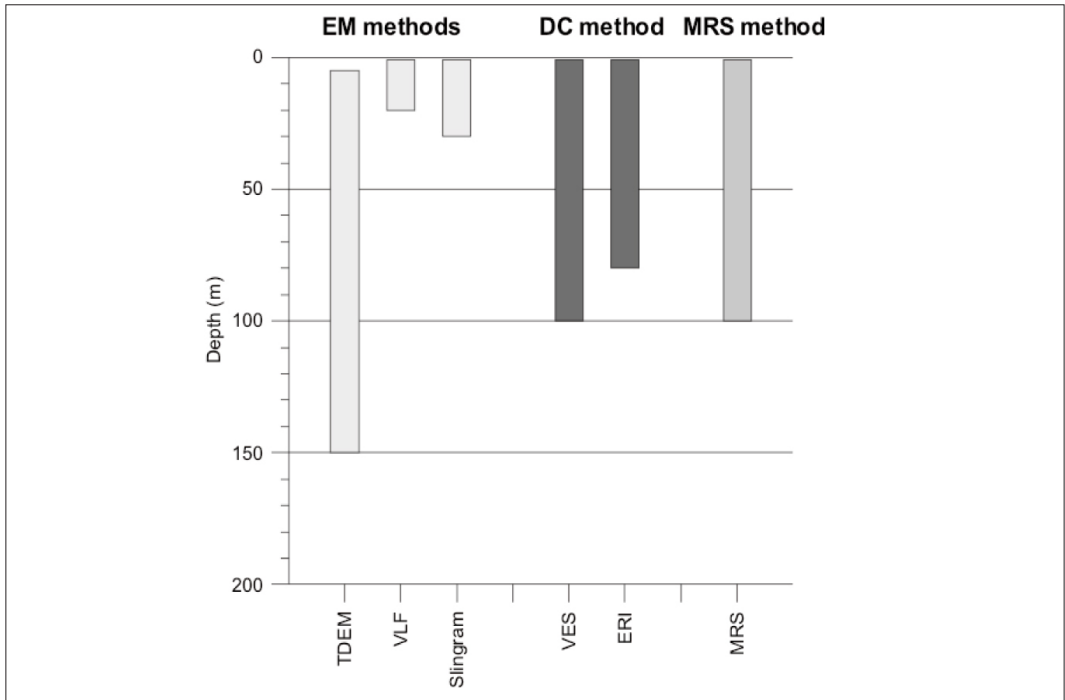
- electrical resistivity measurement is the reference method, because it can be used in a wide range of contexts and can also give 2-dimensional data;
- electromagnetic methods, notably the VLF method, the Slingram method and TDEM soundings, are easier to use than electrical resistivity measurements but are less versatile;
- MRS is rather difficult to use, but it is the only method that gives direct information on the existence of groundwater.

Finally, it should be noted that whatever the geophysical method used, the validity of the study depends on the quality of the measurements performed in the field, and on the number and variety of other observations and complementary analyses performed.

### 4.1.2 THE CHOICE OF METHODS

The choice of geophysical methods depends on the geological context in question and the information required. The method, or the combination of methods used must form part of an overall prospecting procedure, the determination of which is presented in Section 5. The principal criteria of choice are the following.





**Figure 5.4: Typical sounding depths of the methods and equipment used by ACF.**

*The nature of the water source being sought*

It must have a sufficient effect on the quantity measured in the experiment, which will itself depend on the physical properties of the probed volume (Table 5.III). For example, alluvial groundwater tends to generate proton magnetic relaxation signals that can be detected by MRS. Also, salinity variations in groundwater can cause variations in electrical resistivity that can be detected in TDEM soundings. Table 5.III shows clearly that only MRS measures geophysical parameters directly linked to groundwater.

*The required precision*

This cannot exceed the resolution of the method, or more specifically, that of the equipment to be used. The resolution determines the capacity of a method to detect and characterise a water reserve. It is a function of the sensitivity of the apparatus, but it is also limited by the sensitivity of the equipment used and by the conditions of measurement (signal-to-noise ratio). It is thus not possible to quote a standard resolution for each method. Instead, a typical range of depth of resolution for each hydrological method is usually given (Figure 5.4).

*The scale of the study*

This determines a framework for the practical application of the method, which requires the deployment of equipment in the field. Each type of equipment has its particular modes of operation and can be deployed in various configurations, depending on the type of information sought. Table 5.IV summarises all the various possibilities and presents the principal applications of the main apparatuses used by ACF.

*Cost*

This is best considered as the impact of the geophysical method used on the total cost of the project. Two principal factors must thus be evaluated: on one hand, the cost of carrying out the measurements, and on the other, the savings their use generates, through the reduction in the number

**Table 5.III: Principal geophysical methods used in hydrogeology (the properties whose effects are secondary are in brackets) (from Kearey & Brooks 1984, modified).**

Method	Measured geophysical parameter	Operational physical property	Influence of groundwater
Electrical	Potential difference due to electric currents	Electrical resistivity	Indirect
Electromagnetic	Electromagnetic signals due to induction	Electrical conductivity (magnetic susceptibility and dielectric permittivity)	Indirect
MRS	Proton magnetic relaxation signal in water	Spin and magnetic moment of the hydrogen nucleus	Direct

**Table 5.IV: Typical geophysical methods and domains of hydrogeological application.**

Method	Array	Application	Domain of use
DC METHODS	RP (single and double line)	Preliminary study: resistivity profile qualitative 1D interpretation	All formation types, but possible difficulties implanting electrodes and assuring good electrode-earth contact Sounding depth limited if surface is highly conducting (clay, saltwater)
	VES (Schlumberger, Wenner, pole-dipole; pole-pole)	Complementary study: log of resistivity quantitative 1D interpretation	
	Multidirectional soundings	Complementary study: directional log of resistivity qualitative 2-3D interpretation	
	ERI (Wenner, pole-pole, pole-dipole, dipole-dipole)	Complementary study: section of resistivity quantitative 2D interpretation	
EM METHOD	VLF (pole-dipole, dipole-dipole)	Preliminary study: profile and map of iso-resistivity qualitative 1-2D interpretation	All except highly resistive formation types Sounding depth limited if surface is highly conducting for VLF and Slingram
	Slingram (multi-frequency)	Preliminary study: profile and map of iso-conductivity qualitative 1-2D interpretation	
	TDEM sounding	Preliminary & complementary study: log of resistivity quantitative 1D interpretation	
MRS	1D sounding	Complementary study: qualitative 1D interpretation or quantitative if calibrated (log of storativity and hydraulic conductivity)	Continuous formations  Impossible in the presence of magnetic rocks

of negative wells and boreholes. Knowing the cost of the geophysical studies and of that of a negative borehole calculated on the same basis, one can define the economic domains of use of the various methods, or combinations of methods. The relation can be written:

$$r \cdot bh = r \cdot bh^+ + (1 - r) \cdot bh^- + \rho$$

$$bh = bh^+ \frac{1 - r}{r} \cdot bh^- + \frac{\rho}{r}$$

where  $r$  is the borehole success rate (%),  $bh$  the average cost of an exploitation borehole,  $bh^+$  the average cost of a positive borehole,  $bh^-$  the average cost of a negative borehole and  $\rho$  the average cost of geophysical studies per borehole. Systematic geophysical studies will save money in the programme if:

$$\rho \leq bh^- \cdot \left[ \frac{r_p}{r} - 1 \right]$$

where  $r$  is the borehole success rate without geophysical studies, and  $r_p$  the borehole success rate with geophysical studies. These rates can be estimated from the experience of local people or from previous ACF programmes.

However, the cost evaluation of programmes alone is not sufficient to decide what actions should be undertaken in an ACF programme. The calculation does not take into account the fact that geophysical studies often enable the construction of successful boreholes in difficult zones in which the population's water requirements are substantial. ACF's objective is to respond to the needs of vulnerable populations, even where this may not seem 'economically' justified.

#### 4.1.3 GEOPHYSICAL PROCEDURES

Using the criteria of choice of methods, and with ACF's experience, standard geophysical procedures can be constructed. However, these procedures must form part of a hydrogeological investigation strategy, whose conception is explained in Section 5. These standard procedures are thus suggestions, which can be modified (Table 5.V). Examples of real cases are given in Chapter 5B.

## 4.2 The Electrical Resistivity method

To improve readability, the scientific references used in the following Section are not noted, but they can be found in the reference list.

### 4.2.1 THE PRINCIPLE

The principle is to feed a direct current flow into the ground, and use it to measure the apparent resistivity of the formation. The nature and structure of the aquifers are then deduced on the basis of the variations (contrasts) in the calculated resistivity.

The electrical resistivity of a medium is the physical property that determines its capacity to oppose the passage of electric current. In rocks, the flow of current by electron movement is rare ('electronic' or 'metallic' conductivity in certain mineral seams) and the charge transport is essentially due to ions moving in solution (electrolytic conductivity). Thus, the resistivity of the rocks depends essentially on:

- the nature and the weathering of the rock (electrolyte distribution in the ground);
- the water concentration (saturation of the rock with electrolyte);
- the water quality (mineralisation of the electrolyte);
- the temperature (electrolyte viscosity and ion mobility).

The ranges of real resistivity values found generally in the field are presented in Table 5.VI.

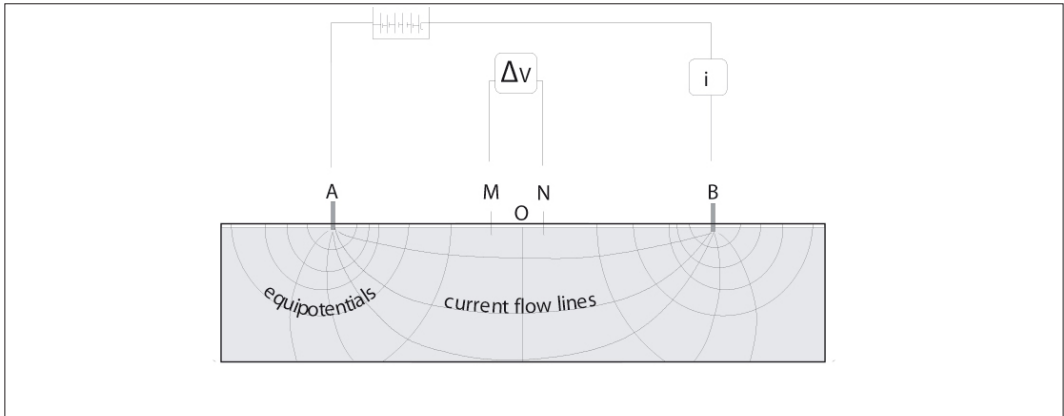
**Table 5.V: Standard geophysical procedures.**

FORMATION	Continuous (sedimentary non-consolidated)	EM Resistivity mapping VLF or Slingram	Delimitation of hydrogeological domains Characterisation of the capping layer (clay content)
		VES if formation is resistive TDEM if formation is conducting	1D description of the structures Estimation of the water mineralisation
		ERI Estimation of the water mineralisation	2D description of the structures
		MRS	Confirmation of the presence of groundwater Characterisation of the storativity and transmissivity of the aquifers
		BEL	Localisation of productive zones Choice of borehole drilling equipment
	Discontinuous (basement)	Resistivity Slingram or RP profile	Estimate of the thickness and the nature of weathering
		VES (occasionally TDEM)	1D description of the structures
		ERI MRS	2D description of the structures Confirmation of the presence of groundwater Characterisation of the storativity and transmissivity of the aquifers
		BEL	Localisation of productive zones Choice of the borehole drilling equipment
		Karstic	EM Resistivity mapping VLF or Slingram
ERI	2D estimation of the structures		
MRS	Localisation of saturated zones (epikarst and shallow dissolution patterns)		

**Table 5.VI: Real resistivities generally encountered in various formations.**

Formations	Resistivity of saturated formations* ( $\Omega\text{m}$ )	Resistivity** ( $\Omega\text{m}$ )
Clays	5 to 10	0.5 - 5
Sands	50 to 400	40 to 300
Gravels	150 to 500	200 to 500
Crystalline shales	100 to 10 000	
Solid gneiss		1 000 to 10 000
Weathered dry gneiss		300 to 600
Weathered wet gneiss		120 - 200
Solid granites	100 to 50 000	1 000 to 10 000
Weathered dry granite		300 to 1 000
Weathered wet granite		100 - 300
Chalk	100 to 10 000	50 - 300
Seawater	< 0.2	
Saline groundwater	< 1	
Fresh surface-water	0 to 300	
Limit of potability	2 to 6	

\* According to Meyer 1991. \*\* ACF experiments.



**Figure 5.5: Principles of geophysical electrical measurements.**

#### 4.2.2 MEASUREMENTS

To measure resistivity, a direct current is fed into the ground via two electrodes A and B, and the potential difference ( $\Delta V$ ) generated is measured between two electrodes M and N (Figure 5.5).

The electrical resistivity of the formation through which the current passes is calculated using the formula  $\rho_a = K \cdot \Delta V_{MN} / I_{AB}$  with  $\rho_a$  the apparent resistivity in ohm-metres ( $\Omega m$ ),  $\Delta V_{MN}$  the potential difference in volts (V),  $I_{AB}$  the direct current in amperes (A) and K a geometric factor such that:

$$K = \frac{2\pi}{1/AM - 1/BM - 1/AN + 1/BN}$$

The resistivity  $\rho_a$  is called the “apparent resistivity”, because it corresponds to the resistivity of the whole set of formation types through which the current flows, which may be different from the real resistivities of each formation type. These are calculated later, from the apparent resistivities, during the data analysis phase of the work.

The penetration depth of the current-flux lines (and consequently the depth probed) is a function of the separation of electrodes A and B.

There are four types of measurement, each associated with a particular area of investigation:

- Vertical Electric Sounding (VES) explores the layers of ground lying between electrodes M and N. It can therefore measure the resistivity as a function of depth, by progressively increasing the distance AB (one-dimensional sounding);
- Resistivity Profiling (RP) identifies the horizontal development (at constant depth) of a set of formations along a profile. It is therefore possible to measure variations in thickness of a formation along a profile. The thickness of formations being tested is given by length AB, which is maintained constant throughout the profile;
- Electrical Resistivity Imagery (ERI) gives a cross-section of resistivity measured and interpreted in two dimensions. It therefore collates information given by the sounding (vertical variation) and by the traverse (horizontal variation);
- Square Sounding reveals anisotropy. A coefficient and direction of anisotropy can thus be calculated, as well as average resistivity.

A number of electrode arrays are commonly used:

- the *Schlumberger array*, with four electrodes placed in line such that  $AB > 5 MN$  (Figure 5.6), is the most frequently used for VES. It offers the advantage over the Wenner method of having to move only two electrodes (A and B) and offering a good depth of penetration;

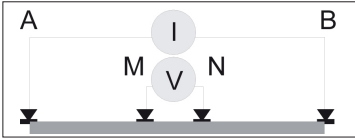


Figure 5.6: Schlumberger array.

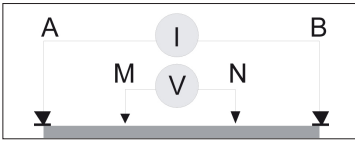


Figure 5.7: Wenner array.

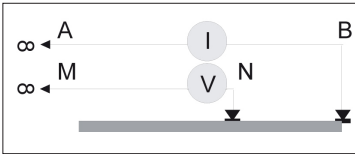


Figure 5.8: Pole-pole array.

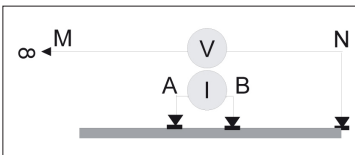


Figure 5.9: Half-Schlumberger array.

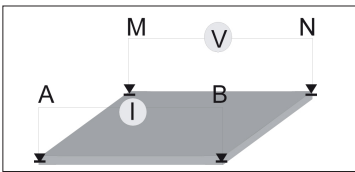


Figure 5.10: Square array.

- the Wenner array, with four in-line electrodes such that  $AM = MN = NB$  (Figure 5.7), is widely used for electrical resistivity imagery (symmetrical array);
- the pole-pole array consists of placing two electrodes (M and A) at ‘infinity’ and only moving B and N (Figure 5.8). It offers a high signal-to-noise ratio and thus allows considerable investigation depths to be reached, and is more sensitive to vertical anomalies than the quadrupole array;
- the pole-dipole or half-Schlumberger array can be used in VES and ERI. By doing two ‘inverted’ measurements, it is possible rapidly to obtain information about the heterogeneity of the formation (Figure 5.9);
- the square array, with  $AB = MN = AM = BN$  (Figure 5.10), is mainly used to perform soundings. It allows anisotropy to be estimated, notably directions of fracture, but it is difficult to carry out in the field.

For all these configurations, exchanging the positions of the current electrodes A & B with those of the of potential electrodes M & N does not in theory affect the results. A large spacing between the potential electrodes gives a strong measured signal ( $\Delta V$ ): this is an advantage in environments without much noise, in which the signal-to-noise ratio will thus be enhanced, but it is a disadvantage in noisy zones (stray currents, telluric currents) in which noise will also be increased.

#### 4.2.3 THE METHOD IN PRACTICE

##### 4.2.3.1 Equipment and personnel

ACF has developed a device suited to the particular conditions in which it operates: the  $\Omega$ mega resistivity-meter (Figure 5.13). Instructions for use are given in Annex 8A. The operating method

**Box 5.1**  
**Electrical geophysics.**

*Resistivity*

The current across a conductor is equal to the voltage, divided by a constant – the resistance. Ohm’s Law is expressed as:

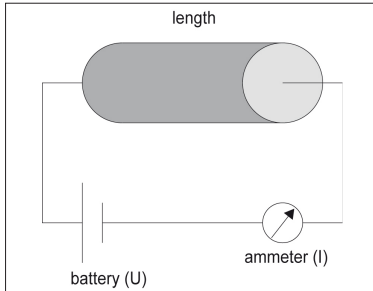
$$U = RI$$

where U is voltage (volts), R resistance (ohms), and I current (amperes). This law is only strictly valid for metallic conduction, but it is an acceptable approximation for electrolytic conduction.

The relation between resistance R and resistivity is:

$$R = \rho \cdot \frac{L}{S}$$

where R is resistance ( $\Omega$ ),  $\rho$  resistivity ( $\Omega \cdot m$ ), L conductor length (m) and S conductor cross-sectional area ( $m^2$ ) (Figure 5.11).



Most rocks are isotropic – they have the same resistivity in all directions. However some, e.g. metamorphic rocks, have oriented structures, and are sufficiently anisotropic for this simplification not to be valid.

**< Figure 5.11: Resistivity, function of the conductor geometry.**

*Geometric coefficient K*

A current I passing through an electrode located in an infinite and isotropic space (Figure 5.12) creates a potential V at point M, such that:

$$V_M = \rho \cdot \frac{I}{4\pi r}$$

**< Figure 5.12: Infinite and semi-infinite spaces.**

In the semi-infinite space of a hemisphere defined by the ground surface:

$$V_M = \rho \cdot \frac{I}{2\pi r}$$

If a current I passes through two electrodes A and B, it is possible to measure the potential difference between two other electrodes M and N due to the joint action of A and B as:

$$V_M = V_A + V_B = \frac{\rho I}{2\pi AM} - \frac{\rho I}{2\pi BM} = \frac{\rho I}{2\pi} \left( \frac{1}{AM} - \frac{1}{BM} \right)$$

$$V_N = V_A + V_B = \frac{\rho I}{2\pi} \left( \frac{1}{AN} - \frac{1}{BN} \right)$$

$$\Delta V_{MN} = V_M - V_N = \frac{\rho I}{2\pi} \left( \frac{1}{AM} - \frac{1}{BM} - \frac{1}{AN} + \frac{1}{BN} \right)$$

The resistivity is therefore obtained by:

$$\rho = \frac{\Delta V_{MN}}{I} K$$

where K is a geometric coefficient:

$$K = \frac{2\pi}{1/AM - 1/BM - 1/AN + 1/BN}$$



**Figure 5.13:  $\Omega$ mega-resistivity-meter (ACF, Cambodia, 1998).**

consists of taking successive measurements for different electrode spacings. The measurement files given in Annex 8B show values of current,  $\Delta V$ , and apparent resistivity ( $R_{oa}$ ) calculated for every measurement point in the field. Values of the geometric coefficient are pre-calculated for standard proposed measurement steps. It is nevertheless possible to modify them in the light of experience, and to prepare a sheet of values adapted to local conditions. It is important to calculate the apparent resistivity values and to draw curves directly in the field to check the consistency of the measurement. This equipment is used to perform one-dimensional measurements (soundings and profiles).

It is of course possible to perform measurements in the field with other equipment. In particular, ACF has successfully used Syscal resistivity-meters and Iris Instruments multi-electrode systems (Figure 5.14). With this equipment, the measurements can be automated, the values of  $I$ ,  $\Delta V$  and  $R_{oa}$  are recorded in an internal memory and the quality of the measurements is improved considerably (higher voltmeter sensitivity, advanced spontaneous potential (SP) correction, measurement dispersion analysis etc.). In view of these possibilities, this equipment is particularly well suited to two-dimensional measurements (ERI).



**Figure 5.14: Syscal R1 resistivity-meter (ACF, Mozambique, 2000).**



A compass is needed to determine the measurement direction, as well as two 100-m measuring tapes strong enough to be used to measure the spacing of electrodes.

To carry out a sounding or a profiling, about twenty electrodes allow part of the array to be put in place before taking measurements. This helps to avoid induced currents created when the electrodes are set up. When setting up ERI, the number of electrodes required depends on the length of the section to be measured and the capacity of the equipment: 64, 72 or 96 electrodes are generally necessary.

A team of five people can perform between 2 and 10 measurement sessions per day, depending on local constraints: when safety requires short days on site, it is difficult to carry out more than two sets of measurements per day. An engineer must define the parameters of the measurement and interpret the data. Four operators are put in charge of setting up the electrodes and spacing the coils.

#### 4.2.3.2 Constraints

Studies in the field are limited by the extent of the exploration zone: it is therefore essential to choose a potentially favourable zone rather than to attempt to cover a very large sector. Similarly, it is necessary to try to carry out studies in a relatively flat area, where vegetation and constructions do not prevent the placing of sufficiently long A-B lines (300 to 800 m). Flooded zones and periods of heavy rain should also be avoided, because the electric measurements may be disrupted in such conditions.

The nature and thickness of capping layers are sometimes limiting factors in the use of this technique. Conducting surface formations require significant injection powers to permit the current to penetrate very deeply into the ground. Thus, resistivities of 5 to 10  $\Omega\text{m}$  allow survey depths of 30 to 50 m with the  $\Omega$ mega-resistivity-meter in Schlumberger surveys (ACF Cambodia, 1998).

Conversely, in some unconsolidated sands it is necessary to wet the contact pegs in order to improve contact and facilitate passage of the current.

#### 4.2.3.3 Vertical Electrical Sounding (VES)

##### Implementation

Schlumberger soundings are carried out by progressively separating electrodes A and B, without changing M and N: this increases the volume of ground through which the majority of the current passes, thereby increasing the depth of investigation (Figure 5.15).

Increasing the investigation depth while maintaining the same injection power causes the measured  $\Delta V$  value to decrease progressively. To maintain it at an acceptable level (typically between 1 and 5 mV), the injection power is increased. When the power of the resistivity-meter is no longer sufficient to obtain adequate  $\Delta V$  values, overlapping measurements are carried out. This consists of increasing the separation of electrodes M and N, and measuring  $\Delta V$  over a greater volume of earth. The values obtained can be compared with those recorded with the initial spacing. It is essential to carry out the overlap on a minimum of two measurement points in order to check for accuracy.

The example shown in Figure 5.16 corresponds to the survey performed in a gneiss rock area in Sudan. Two overlaps were carried out:

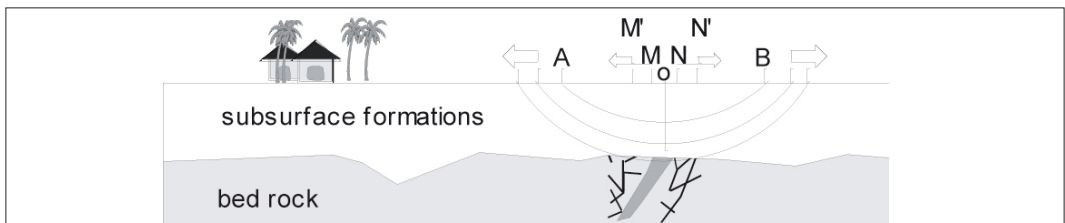


Figure 5.15: Implementation of Schlumberger VES.

- the first, at  $\Delta V = 26$  mV for MN = 2 m, and  $\Delta V = 266$  mV for MN = 10 m. This overlap was carried out at three measurement points (AB/2 = 15, 20 and 25 m);
- the second at  $\Delta V = 5.6$  mV for MN = 10 m and  $\Delta V = 24.6$  mV for MN = 40 m. This overlap was carried out at two points.

The two overlaps are satisfactory, in that the apparent resistivity values and slopes of curves before and after the overlap are close (Figure 5.16).

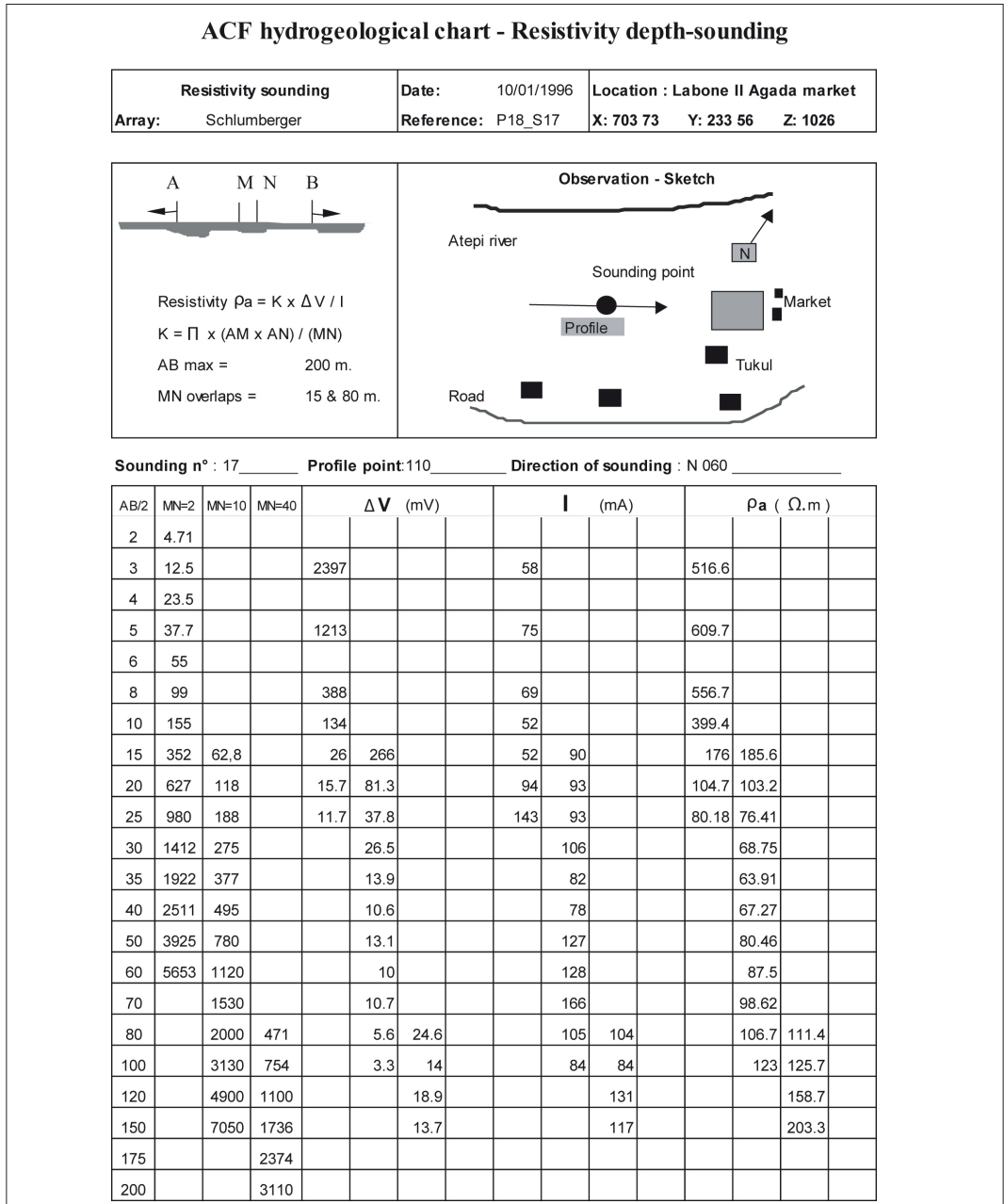


Figure 5.16: Example of Schlumberger VES in bedrock (ACF, Sudan, 1996).

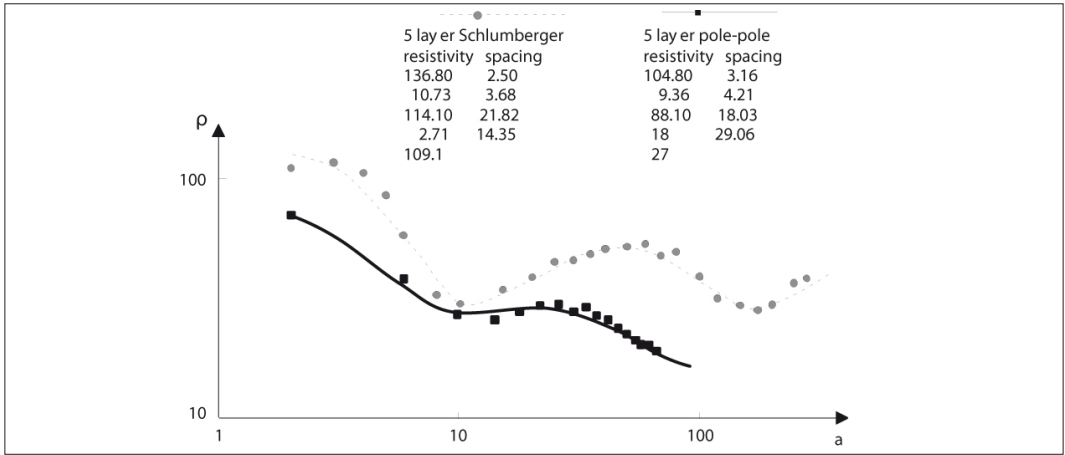


Figure 5.17: Example of a pole-pole survey (ACF, Siem Reap, Cambodia, 1998).

The Wenner array avoids the need for overlaps because between each measurement the distance MN is progressively increased along with AB.

The pole-pole array is rarely used in Vertical Electric Sounding, because its resolution is not as good as that of quadrupole arrays (Schlumberger or Wenner). Additionally, it requires the electrodes to be located at 'infinity' (A and M), which means a distance of at least 20 times the largest B-N spacing which is not always easy in the field. The investigation depth is given by the spacing (a) of mobile electrodes B and N.

The main advantage of the pole-pole survey method lies in its rapidity (only 2 electrodes to move, no overlap) and its depth of penetration, which is greater than that of a Schlumberger survey of the same line length.

Examples of pole-pole and Schlumberger soundings taken by ACF in Cambodia are shown in Figure 5.17. The results prove to be comparable for the two configurations. It is also noticeable that, for a = 80 m, the investigation depth of the pole-pole method is much greater than that of the Schlumberger method for AB/2 = 40 m. On the other hand, contrasts are much more clearly defined by the Schlumberger method.

The pole-dipole array, or half-Schlumberger sounding has the advantage over the other arrays of enabling two soundings to be taken at the same location by simply reversing the position of the infinite distance electrode (Figure 5.18).

In a one-dimensional medium the two soundings are identical; any difference means that the medium is heterogeneous and one-dimensional soundings are inadequate (see Box 5.2).

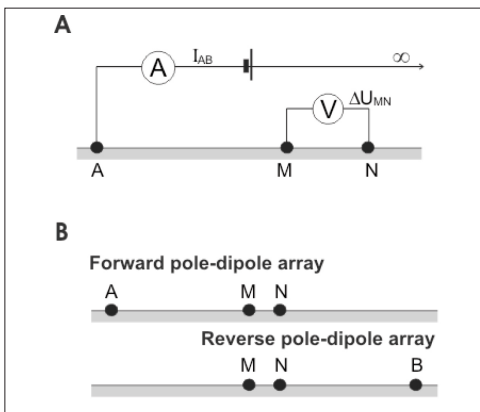


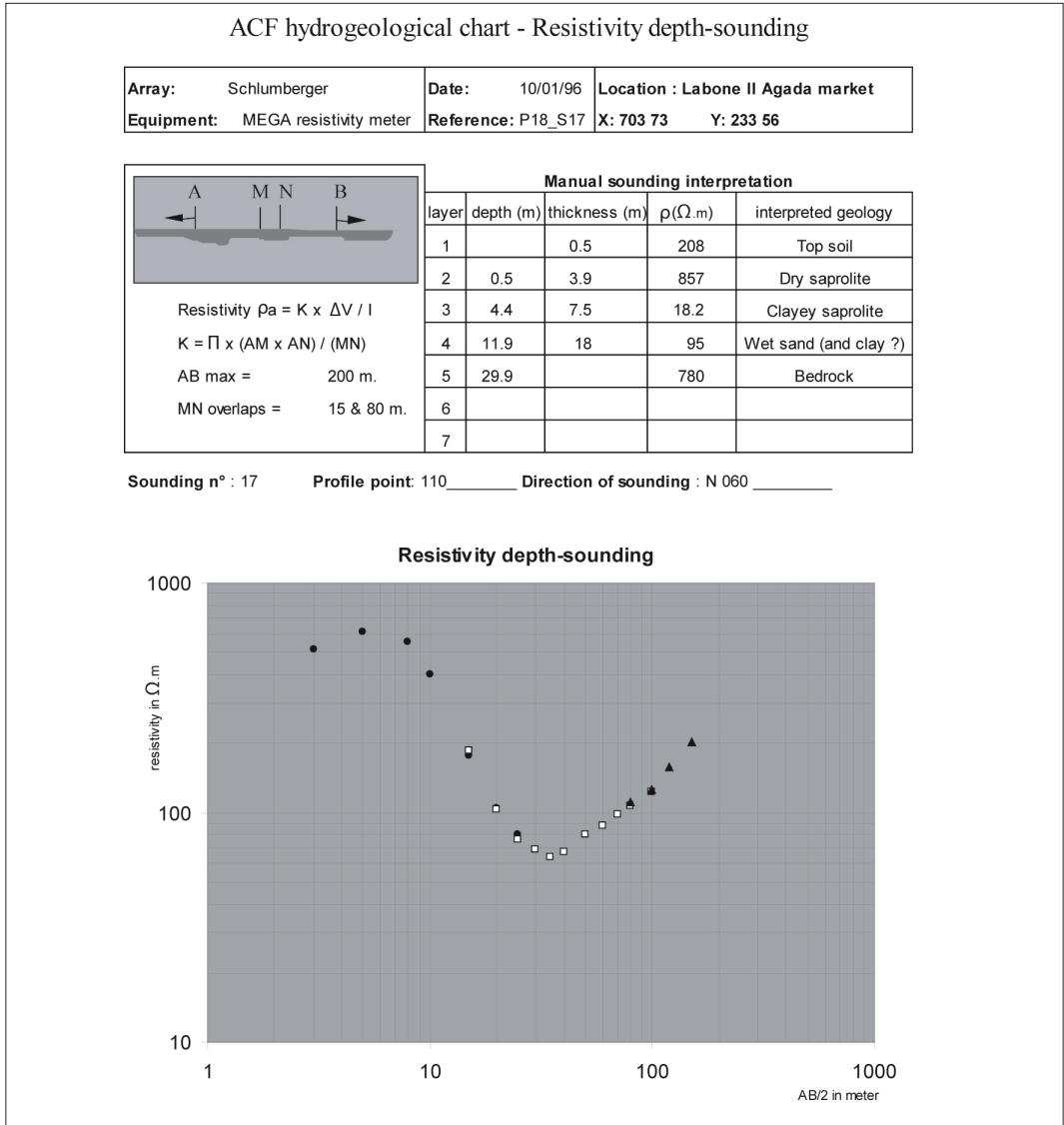
Figure 5.18: Half-Schlumberger sounding. A: principle. B: arrays.

*Interpretation*

The number of layers, their true resistivities, and their respective thicknesses may be estimated from the apparent resistivity measurements. There are several methods of interpretation. The simplest is the auxiliary curve or Hummel method, but interpretation software is also available (see Box 5.2).

Whatever the interpretation method, a calibration process has to be applied for every new geological zone. This means taking soundings from existing boreholes, and also on visible outcrops, to calibrate the results of the interpretations (number of layers, calculated resistivities and thicknesses) with the lithological data. Only after this calibration process can the interpretation of the geophysical measurements have any meaning.

The example shown in Figure 5.19 is from a crystalline bedrock context in Sudan. The aquifer potential is provided by an 18-m thick layer with a resistivity of 95 Ωm. Its calculated resistivity



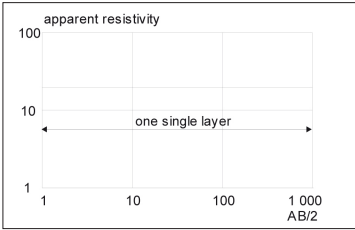
**Figure 5.19: Results of VES interpretation (ACF, Sudan, 1996).**

**Box 5.2**  
**Interpretation of VES.**

Results are plotted on log-log paper with values of  $AB/2$  (abscissa in meters) plotted against apparent resistivity values measured in the field (ordinate in  $\Omega.m$ ). The experimental curve of the survey is obtained in this way. This curve is then compared with the theoretical curves in order to estimate the true resistivities and formation thickness.

*Nomenclature*

- Apparent resistivity:  $\rho_a$
- Calculated resistivity of formation n:  $\rho_n$
- Calculated resistivity of theoretical formation:  $\rho_f$
- Thickness of formation n:  $e_n$

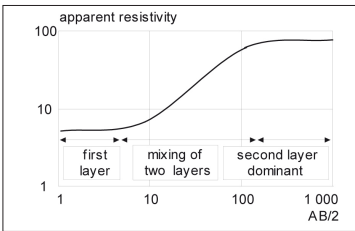


*Curves*

An electrical survey carried out on a single isotropic layer gives an experimental curve (Figure 5.20) that is simply a horizontal straight line ( $\rho$  is constant as a function of depth, which is given by  $AB/2$ ).

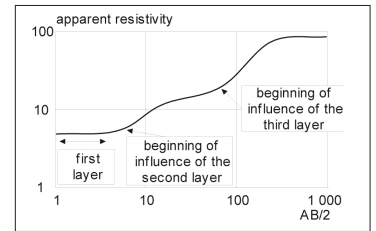
<  
**Figure 5.20: Single-layer curve.**

A survey carried out on a two-layer profile gives a relatively simple curve (Figure 5.21). The first section corresponds to the first layer (curve from one layer), and the slope of the zone of influence of the two formations is given by the ratio  $\rho_2/\rho_1$ . When  $\rho_1 < \rho_2$ , the curve is rising; if  $\rho_1 > \rho_2$ , it is falling. The end of the curve, as  $AB/2$  tends towards infinity, tends to a value corresponding to the resistivity of the second formation.



A survey of three layers is also characterised by the ratio of the resistivities. The example corresponds to a curve for which  $\rho_1 < \rho_2 < \rho_3$  (Figure 5.22).

<  
**Figure 5.21: Two-layer curve.**



>  
**Figure 5.22: Three-layer curve.**

*Principles of manual interpretation, nomograms*

The idea is to compare the experimental and theoretical curves replotted as nomograms. There are various types of nomogram used in the interpretation of electrical surveys. The operating methods however are very similar for all. The Cagniard nomograms, used for the Schlumberger array, are included in Annex 8 C. There are in fact two sets of nomograms: the 'two-formation' nomogram and the three auxiliary nomograms.

The two-formation nomogram is a set of theoretical curves drawn on log-log paper that indicate  $\rho_a$  as a function of  $AB/2$  for different values of the ratio  $\rho_2/\rho_1$ .

When the ground includes more than two layers, the auxiliary nomogram method is used. This consists of reducing any survey of  $n$  layers to a succession of soundings of two layers: all soundings start with the interpretation of a survey of the first two layers. These two layers are then replaced by an electrically-equivalent theoretical layer. With the third layer, this theoretical layer forms a pair of theoretical layers (principle of reduction). This then continues as an iterative process until the last layer is reached.

*Operational method*

The experimental curve is drawn in the same way on transparent log-log paper at the same scale as the nomograms ( $AB/2$  as abscissa,  $\rho_a$  as ordinate).

The values of  $\rho_1$ ,  $\rho_2$  and  $e_1$  are then estimated by simple superposition of the "two-formation" nomogram and the beginning of the experimental curve, selecting the theoretical curve that best corresponds to the experimental curve, while maintaining the axes parallel. The origin of the curves in the nomogram, termed the left cross, gives as abscissa the thickness of the first formation  $e_1$  and as ordinate the true resistivity of the first formation  $\rho_1$ . On the theoretical curve selected, ratio  $\rho_2/\rho_1$  enables  $\rho_2$  to be calculated. The position of the left cross is indicated on the experimental curve.

To evaluate  $\rho_3$ , the auxiliary nomogram is taken as a function of ratio  $\rho_3/r_1$ . The experimental curve is superimposed on the auxiliary nomogram with its origin coinciding with that of the previously-drawn left cross. On the experimental curve is traced the curve of the auxiliary nomogram corresponding to the previous ratio  $\rho_2/\rho_1$ ; this curve represents the geometric location of the origin of the two-formation nomogram. The two-formation nomogram is then taken while maintaining its origin on this curve and adjusting it to the form of the experimental curve. By marking a new cross as the origin of the two-layer nomogram, the value  $r_f$  of the theoretical formation (electrically equivalent to the first two formations) is obtained as ordinate. From the ratio  $\rho_3/\rho_f$  read from the selected theoretical curve,  $\rho_3$  is obtained.

$e_2$  is estimated by replacing the auxiliary nomogram on the experimental curve, ensuring that its origin coincides with the origin of the first left cross. The site of the second cross of the two-formation nomogram has as abscissa the ratio  $e_3/e_f$ . The value of  $e_f$  is given as the abscissa of the first left cross position.

This process is iterated up to the end of the experimental curve in order to obtain all the true resistivity values ( $\rho_n =$  ordinate of the left cross x ratio  $\rho_{fn}/\rho_f$ ) of layers and all their thicknesses ( $e_n =$  abscissa left cross x ratio  $e_n/e_f$ ), except for the last layer.

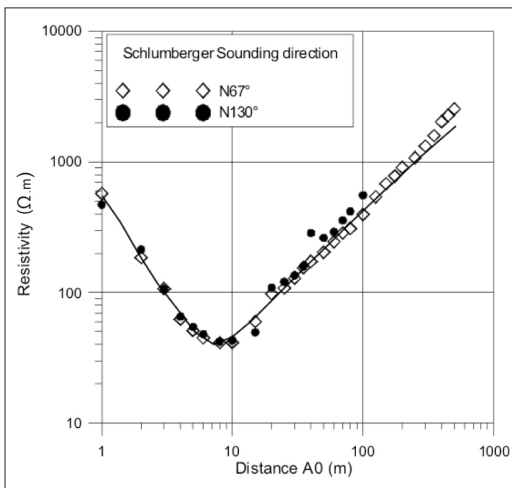
#### Errors of interpretation

A little practice in the use of nomograms quickly makes them easy and practical to use. One of the common mistakes made in the early stages is to try to superimpose the experimental curve perfectly on the nomogram, which leads to a multiplication of the number of formation types. In practice, it is preferable to retain a theoretical curve that includes a maximum number of points on the experimental curve, and that also follows its trend well. If this proves difficult, it is always possible to select a curve that corresponds to an intermediate ratio  $\rho_2/\rho_1$  not actually present in the nomogram.

The solution obtained after interpretation is not unique. There are in fact several solutions, known as equivalences, corresponding to different thicknesses and resistivities of layers that give the same experimental curve ( $\rho/e$  or  $\rho.e$ ). It is not possible to choose the correct solution without extra information (thickness of a formation ascertained by borehole, resistivity determined by measurement on an outcrop etc.).

It is also possible that a formation type which is present may not be revealed by the interpretation: this phenomenon of 'suppression' sometimes occurs for formation layers that are not very thick, contained between two other formations of similar resistivity. Again, this can only be discovered through external information.

Also, many soundings lead to erroneous interpretations, because they are carried out in an anisotropic environment (non-parallel and non-horizontal layers, or large lateral variations). It is often possible to account for these during interpretation, when rising curve slopes are greater than  $45^\circ$  or curvatures of maxima and minima are too pronounced to be handled by nomograms. Carrying out a second sounding rotated by  $90^\circ$  and centred precisely on the same point confirms this problem of anisotropy (different curves obtained) and offers a more exact solution (Figure 5.23).



Finally, interpretation using common sense often eliminates certain solutions (aberrant value of  $\rho$ , number of different formations not corresponding to known geological context etc.) and enables the proper solution to be obtained.

**Figure 5.23: Verification of the homogeneous nature of the zone. Two Schlumberger soundings centred on the same point (o) but in almost perpendicular directions bedrock zone in Burkina Faso, ACF, 2003).**

#### Computer interpretation

There are a number of computer programmes which provide rapid interpretation of electrical soundings, although they are all confronted with the same problems as manual interpretation (suppression, equivalence, number of formation types). Software does not provide the same 'feeling' as manual interpretation, but it does have several advantages, notably speed and flexibility, that make it easy to change models and to visualise equivalences and suppressions.

For those with little experience therefore, their use is recommended only for checking the validity of manual solutions. Staff who are experienced

in manual interpretation can, on the other hand, take full advantage of the speed of direct computer interpretation.

ACF has chosen to use the IPI2WIN programme, developed by Moscow State University's Geophysical Laboratory. It is well suited to use in the field, and can be downloaded as freeware ([http://geophys.geol.msu.ru/rec\\_lab3.htm](http://geophys.geol.msu.ru/rec_lab3.htm)). The programme has been modified to suit ACF's requirements, and it is now a very user-friendly, high performance package (comparison between soundings, exploration of the domains of equivalence etc.). It can also interpret data acquired using any of the principal equipment set-ups (Schlumberger, Wenner, pole-pole, pole-dipole).

is however a little low, and it may be that this formation, which corresponds to a fissured/weathered bedrock zone, may be only slightly argillaceous, or that the water is not very mineralised. Only experience and observations in a zone can allow these hypotheses to be confirmed or rejected. It is also possible that this potential aquifer is covered by an argillaceous layer (resistivity 18  $\Omega\text{m}$  on 7.5 m) that provides good protection of the groundwater from surface pollution: it is therefore probable that the aquifer is confined.

#### 4.2.3.4 Square sounding

##### Implementation

A square survey can be used to complement the standard survey in an anisotropic environment. The principle is the same as for the Wenner survey. The main difference is the fact that, for every depth investigated, the apparent resistivity is measured in different directions, the array being turned before separating electrodes A and B to probe to a greater depth.

The array is defined by  $AB = MN$  and  $OA = OB = OM = ON$ . It is located as follows (Figure 5.24), directions being measured from the centre O:

- electrode A positioned at N315;
- electrode N positioned at N135;
- electrode B positioned at N045;
- electrode M positioned at N225.

While carrying out measurements in this configuration, the direction of measured resistivity is N090/N270 (parallel to the AB direction and MN). The angle between North and the direction of measured resistivity is then  $\alpha = 90^\circ$ . Reversing the connections of electrodes M and B on the resistivity-meter (Figure 5.25), a new configuration is obtained so that the apparent resistivity direction is N000°. The angle  $\beta = 0^\circ$  is then defined. To obtain supplementary directions, the square array is rotated through an angle, e.g.  $30^\circ$  (Figure 5.26).

The array A1,B1,M1,N1 gives apparent resistivities for directions  $\alpha_1 = 90^\circ$  and  $\beta_1 = 0^\circ$ , the A2,B2,M2,N2 array for directions  $\alpha_2 = 120^\circ$  and  $\beta_2 = 30^\circ$ , and the A3,B3,M3,N3 array for directions  $\alpha_3 = 150^\circ$  and  $\beta = 60^\circ$ .

In the field, the angle of rotation of the array depends on the required degree of precision: in general,  $30^\circ$  or  $45^\circ$  is used. If the direction of fracture considered is N 000°, and the angle chosen between each measurement is, for example,  $30^\circ$ , the parameters specified in Table 5.VII are obtained.

When measurements have been taken for a given length AB in all directions, the side of the square may be increased in order to investigate greater depths.

##### Interpretation

The resistivities are calculated by the standard formula:

$$\rho_a = \frac{\Delta V \times K}{I}$$

**Table 5.VII: Parameters of the square array in rotation.**

Direction of lines implemented (direction OB)	Direction of lines obtained by reversing M and B (direction OB)	Direction of resistivities measured with respect to N000°
N 045	N 225	$\alpha_1 = 90^\circ, \beta_1 = 0^\circ$
N 075	N 255	$\alpha_2 = 120^\circ, \beta_2 = 30^\circ$
N 105	N 285	$\alpha_3 = 150^\circ, \beta_3 = 60^\circ$

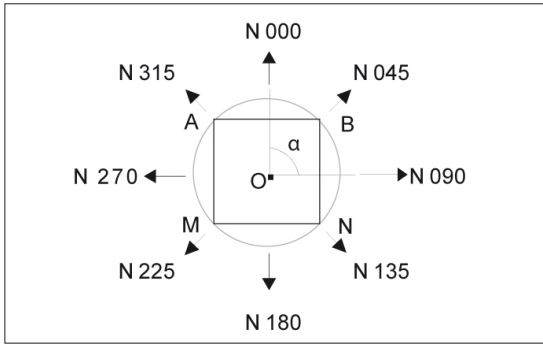


Figure 5.24: Layout for square survey.

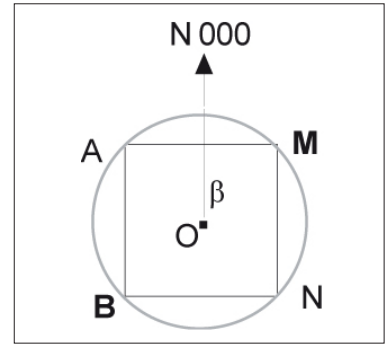


Figure 5.25: Inverted square layout.

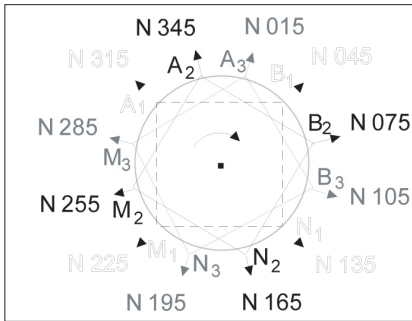
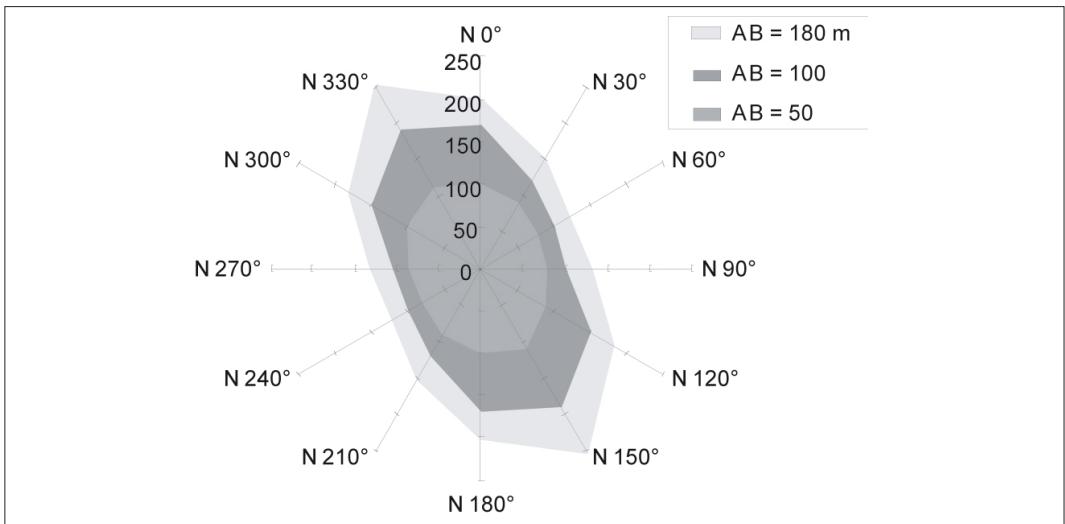


Figure 5.26: Rotation of square layout.

Figure 5.27: Result of square survey.



And:

$$K = \frac{2 \cdot \pi \cdot AB}{2 - \sqrt{2}}$$

Table 5.VIII gives several values of K for lengths AB normally used. Values of resistivity are plotted as a function of direction (Figure 5.27). The direction of anisotropy at various depths is clearly shown graphically. In Figure 5.27 the anisotropy (corresponding to a fractured bedrock zone) in direction N 60° increases with depth.



**Table 5.VIII: Values of K.**

AB (metres) (= MN = AM = BN)	K
180	1 931
140	1 502
100	1 073
70	751
50	536

The descriptive parameters are defined as follows:

- direction of the anisotropy  $\theta$ ;
- coefficient of anisotropy  $\lambda = \rho_a/\rho_b$  (the higher the value of this coefficient, the greater the anisotropy);
- mean resistivity  $\rho_m = (\rho_\alpha \rho_\beta)^{1/2}$ .

For every direction and depth of investigation, it is therefore possible to know the magnitude of the anisotropy ( $\lambda$ ), its direction ( $\theta$ ) and the mean resistivity ( $\rho_m$ ).

#### 4.2.3.5 Resistivity profiling (RP)

##### Implementation

By moving a device of fixed length AB–MN in a given direction (Figure 5.28A), a profile of apparent resistivities of a slice of ground of approximately constant thickness is obtained.

The direction of the profile is chosen on the basis of the supposed directions of the anomalies detected in the field or by photo-interpretation. The ideal procedure is to take a perpendicular slice through the anomaly, in order to determine its width and to estimate its tilt angle (Figure 5.28B).

The profile  $\rho_a'$  shown in Figure 5.28B is obtained for a small length AB, whereas profile  $\rho_a$  corresponds to a larger AB ( $\rho_1 < \rho_2$ ). The electrode spacing AB is therefore determined by the depth under investigation. The measurement step-sizes are a function of the desired precision: a step of 10 m may be taken as standard.

##### Interpretation

The apparent resistivity measurements are plotted on millimetre graph paper, with the length AB/2 as abscissa and the apparent resistivities as ordinate (Figure 5.29).

In bedrock zones, a study by *Burgeap* (1984) shows that anomalies indicated by ER are increasingly favourable when:

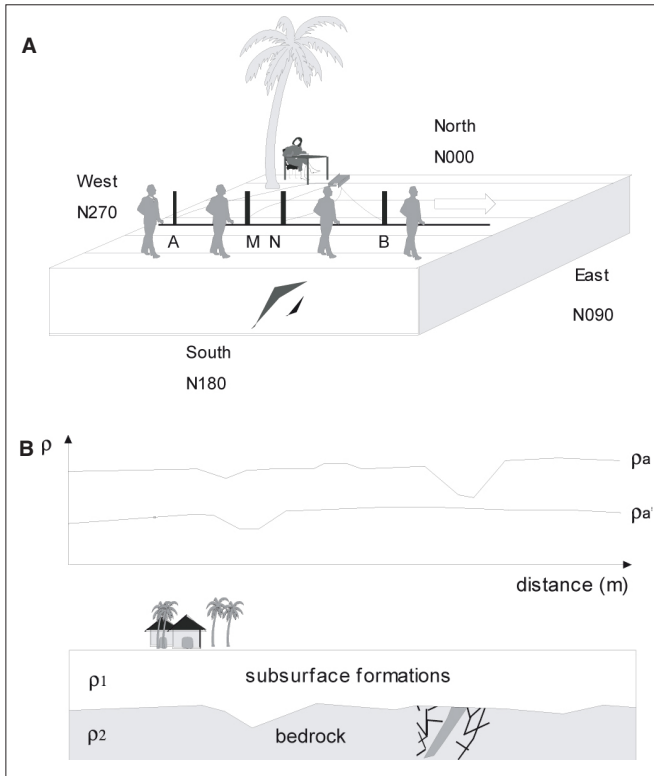
- the width of the anomaly (measured between the two points of inflection) is less than about 50 m;
- the minimum apparent resistivity is between 50 and 120  $\Omega\text{m}^*$ ;
- the resistivity contrast (ratio of apparent resistivity of the surrounding rock to the minimal resistivity of the anomaly) is greater than 1.5. (This value must be larger for wider anomalies.)

#### 4.2.3.6 Electrical resistivity imagery (ERI)

##### Implementation

Electrical resistivity imagery is performed by carrying out a series of measurements in two dimensions. For this purpose, a number of pegs are placed along the profile. Whereas a normal VES needs 4 electrodes, the example shown in Figure 5.30 uses 64 pegs. Each peg is connected to the resistivity-meter via a particular address, and can therefore be used as an electrode for injection (A or B)

\* This spread of resistivity is approximate because it is a function of local conditions. With a little experience of a given zone, it is easy to redefine it.



**Figure 5.28: Resistivity profiling.**  
**A: setting up. B: example.**

or for potential measurement (M or N). A sequence is first recorded in the resistivity-meter memory, defining which pegs will be used for each measurement: all possible combinations of electrodes are thus used for exploring at different depths and at various points along the section. Symmetrical arrays are generally used, such as the Wenner (sensitivity to both lateral and vertical variations) and the dipole-dipole (higher sensitivity to vertical anomalies).

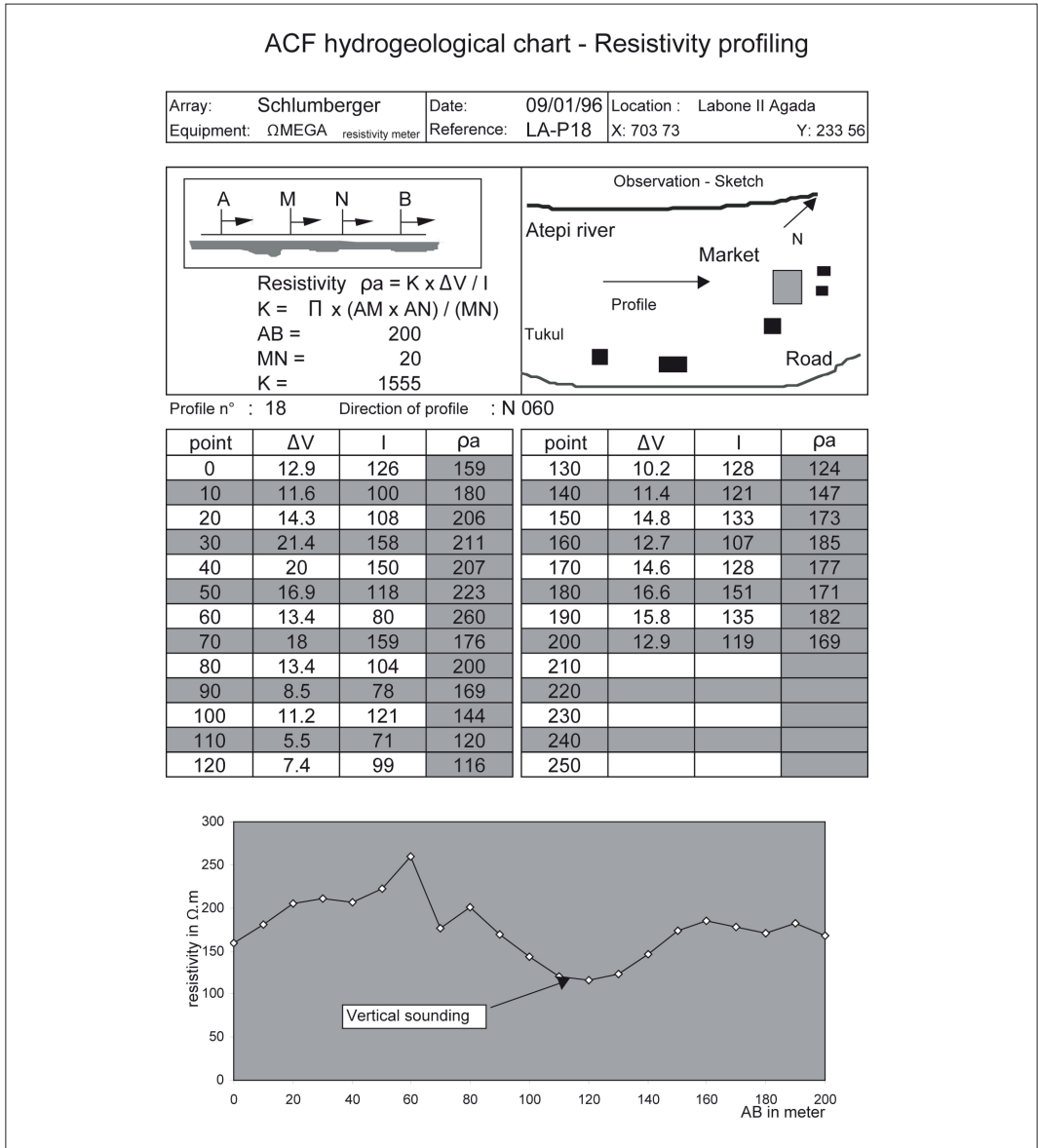
### *Interpretation*

The series of measurements is interpreted using software to calculate the resistivity cross-section of the formation. Figure 5.31 shows a cross-section obtained using resistivity imagery performed by ACF in Mozambique, with a Wenner array (128 electrodes, 4-metre spacing) in a clayey sandstone formation. The usefulness of this method is evident in this type of heterogeneous formation: the calculated resistivity contrasts reveal the geological structures that are interpreted on this example as a zone of clayey sandstone without aquifers in the north-west and a sandy, potentially water-bearing zone to the south-east.

ERI is the only operational method which can be used routinely in humanitarian programmes to perform two-dimensional measurements. It is therefore the method of choice in all heterogeneous environments.

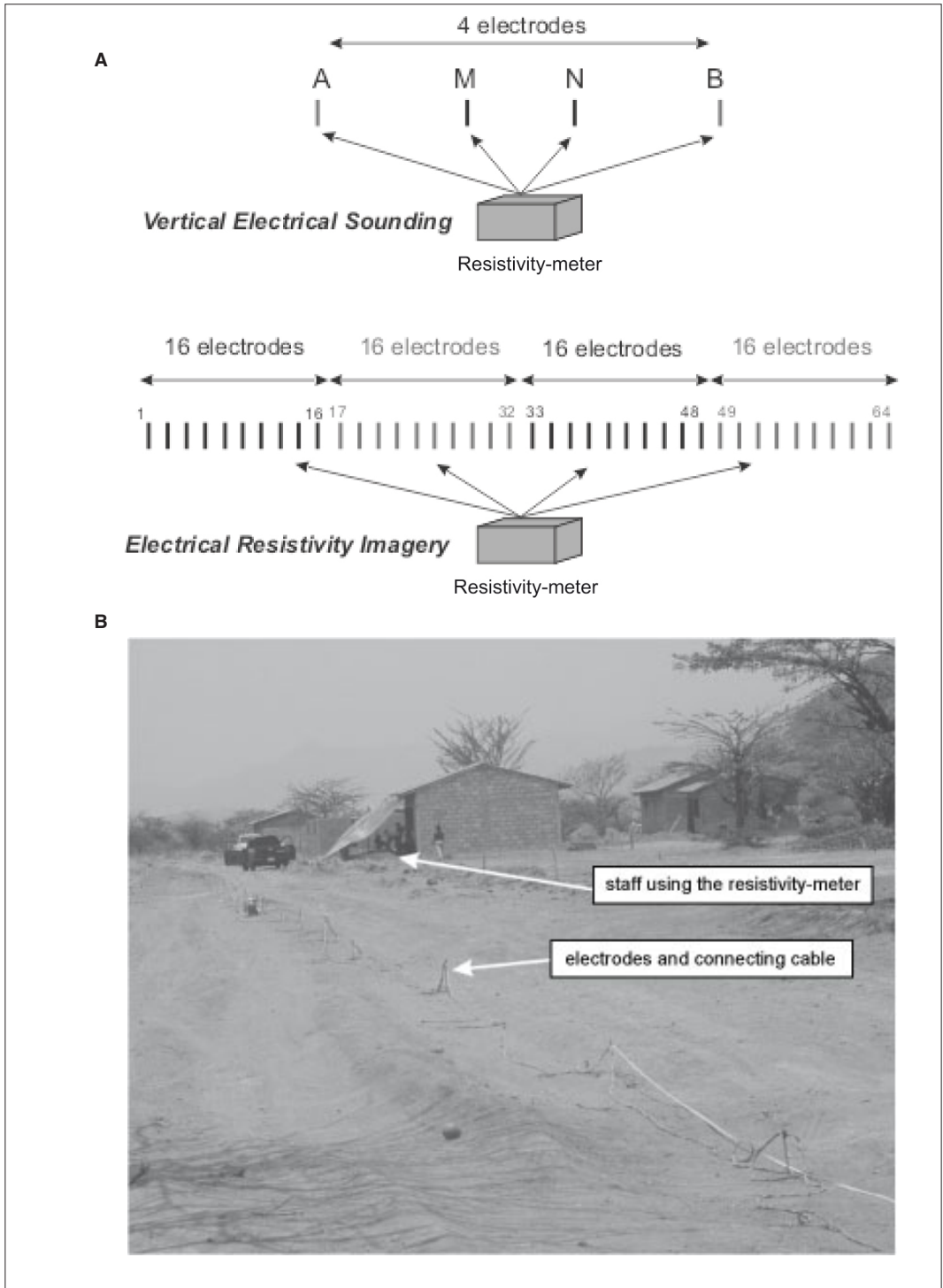
Two programmes are used by ACF to perform ERI. The freeware programme X2IPI developed by the Geophysics Laboratory of Moscow State University ([http://geophys.geol.msu.ru/rec\\_lab3.htm](http://geophys.geol.msu.ru/rec_lab3.htm)) is used to prepare the sequences of measurements which will be recorded by the resistivity-meter and to control and analyse the recordings (analysis of measurements, suppression of noisy data etc.). The RES2DINV programme is used to interpret the apparent resistivities (measurements previously analysed by X2IPI) and to obtain a cross-section of calculated resistivity (Figure 5.31). A basic version of this programme, sufficient for simple data interpretation, is available as freeware (<http://www.goelectrical.com>).

Setting up an ERI survey differs from a standard VES in that all the electrodes must be positioned before beginning the measurements, which take about 45 minutes for a 64-electrode Wenner sequence.



**Figure 5.29: Example of a traverse in a bedrock zone (ACF, Sudan, 1996).**

This example concerns granito-gneissic formations. The Schlumberger array chosen was AB = 200 m, MN = 20 m, with measurement points every 10 m. In the bedrock zone studied, the objective was to identify the largest zones of weathering, as these are the most likely to be an aquifer. Solid (and sterile) bedrock has a high resistivity, while the weathered water-bearing sections are conductive, so that it is possible to identify, at a distance of about 110m in the profile, a zone where the apparent resistivity is lower and which is therefore likely to be weathered to a much greater depth. The VES presented in Figure 5.16 was performed at this 110m point.



**Figure 5.30: ERI measurement array.**

**A: comparison between a normal VES array and an ERI array. B: Wenner array, 64 electrodes and 4-metre spacing used in Honduras (ACF, 2000).**

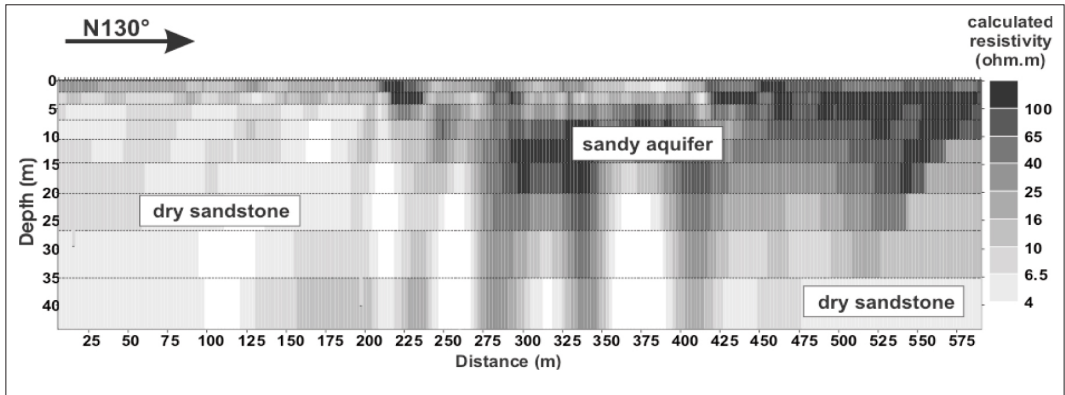


Figure 5.31: Electrical Resistivity Imagery (ACF, Mozambique, 2000).

#### 4.2.3.7 Borehole Electrical Logging (BEL)

Borehole logging is not strictly speaking a method of groundwater exploration, but it forms a part of electric geophysical methodology. Based on the same principle as surface methods, it consists of using different arrays of electrodes to measure resistivities directly in the borehole. When carried out right at the end of the drilling operation, it provides high-precision localisation of water-generating zones, and therefore defines the optimal position of screens.

The main value of this method lies in obtaining the maximum amount of information from reasonably productive boreholes in sedimentary zones, where the passages from sandy to argillaceous zones are progressive. It also provides a clear indication of water mineralisation problems, and therefore of salinity.

#### Implementation

Various types of measurements are possible in electrical logging. The experience of ACF in Cambodia showed that normal probe and fluid resistivity surveys enable the collection of the main information being sought.

Normal probes (Figure 5.32) use a pole-pole configuration: the electrodes B and N are therefore set at infinity (according to Chapellier (2000), B and N can be regarded as infinite when  $MN > 14 AM$ ). The AM spacing determines the 'lateral depth' of investigation. A spacing of 20 cm (N20 probe) gives acceptable precision at layer boundaries, but will be greatly affected by drilling mud. The N80 probe corresponds to a spacing of 80 cm, less accurate in vertical definition, but with a measured resistivity that approximates to the true resistivity.

The fluid resistivity measurement probe uses the Wenner configuration ( $a = 2$  cm) with the four electrodes immersed in the fluid. The fluid resistivity measurement is essential for the interpretation of the other logging measurements. Also, it can indicate, where necessary, the zone of water-intake (which generally exhibits resistivity variations).

The probe developed by ACF can perform temperature and fluid resistivity measurements, spontaneous potential (SP), mono and 8, 16 and 32-cm normal electrodes. This probe is manually lowered into the borehole. The measurement intervals are 50 cm, or less if a more precise definition is required. Measurements are taken at the surface using a specific resistivity-meter.

Direct on-site completion by an operator of an Excel spreadsheet furnishes curves of the measured parameters as a function of depth. It is important to measure the resistivity and the temperature of the fluid and the SP during the descent, when the water in the borehole has not been agitated too much, and that of the normal and mono probes during the ascent.

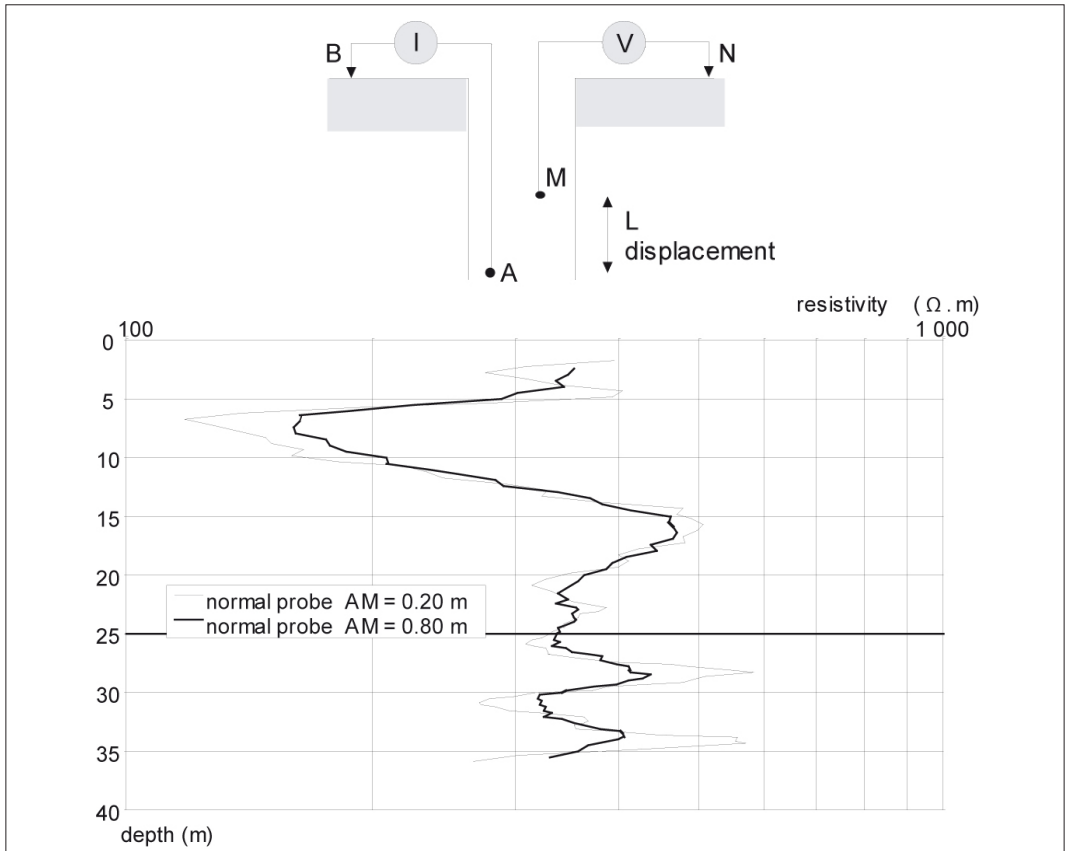


Figure 5.32: Electric logging (ACF, Siem Reap, Cambodia, 1998).

### Interpretation

Resistivity values are calculated *in situ*. Note: the geometric coefficient K corresponds to a complete sphere and not to a hemisphere; it is therefore given by:

$$K = \frac{4\pi}{1/AM - 1/BM - 1/AN + 1/BN}$$

An example of curves for N20 and N80 probes is shown in Figure 5.32. It is from a borehole sunk by rotary drilling (see Chapter 8) using a polymeric mud (ACF Cambodia, 1998) in a clay-sand zone. During the descent, the fluid-resistivity probe did not show any strong contrast at 35 m depth in the borehole (logging carried out some minutes after withdrawal of the drilling pipes) and took one measurement of the resistivity of the drilling mud of 280 Ωm (about 35 μS/cm). The normal probes used during the ascent indicated two zones: a conductive zone centred around 7 m depth, interpreted as argillaceous (= 150 Ωm), and a more highly resistive zone (= 350 Ωm) at 12 to 35 m. Within this more resistive zone, three passages proved to be distinctly more resistive (> 400 Ωm) and are interpreted as aquiferous sands. This interpretation, confirmed by the analysis of cuttings, enabled optimal exploitation of the borehole (Q = 5 m<sup>3</sup>/h).

To exploit BEL information to the full, the results should be interpreted only after applying a certain number of corrections (layer thicknesses, resistivities etc). Then the various measurements should be correlated with each other. See bibliography for more details.

## 4.3 Electromagnetic methods

### 4.3.1 PRINCIPLE

Electromagnetic (EM) methods use those physical properties of the ground that affect the magnitudes of time-varying currents, to study the distribution of conductivity values in the ground (conductivity is the inverse of resistivity).

EM phenomena are classically described by Maxwell's equations, which state that any time-varying electric current produces an electromagnetic wave, which consists of an electric field and a magnetic field propagating in space and oscillating at the same frequency, perpendicular to each other.

In contrast to the method of electrical resistivity measurements, which uses DC current and requires the use of electrodes, EM methods use the induction properties of electromagnetic waves, and do not require direct contact with the ground. They can thus be implemented very quickly. These methods generally have a higher resolution than DC methods in conducting formation types (the phenomenon of induction is much stronger in conducting formations), but resistive formation types are less well defined.

### 4.3.2 MEASUREMENTS

Many techniques can be used to measure the response of the underground formations to an EM stimulus. However, most are based on the same sequence of events:

- *Stimulus*: the 'primary', time-varying (generally oscillating) electric current is created in an electric cable. This current generates a 'primary' magnetic field.
  - *Reaction*: when this primary magnetic field traverses the underground formations, an electromotive force and an associated current are created by induction in these formations. This 'secondary' current, in turn, generates a secondary magnetic field.
  - *Reception*: the secondary magnetic field also traverses the underground rock formations and induces a signal in a receptor placed at the surface. Various quantities can thus be recorded: the resultant field of the primary and secondary fields, the secondary field on its own, the electric or magnetic components etc. These data are then analysed to yield information about underground conductivity.
- ACF programmes have employed several EM methods:
- the VLF method;
  - the Slingram method;
  - TDEM soundings.

### 4.3.3 THE VLF METHOD

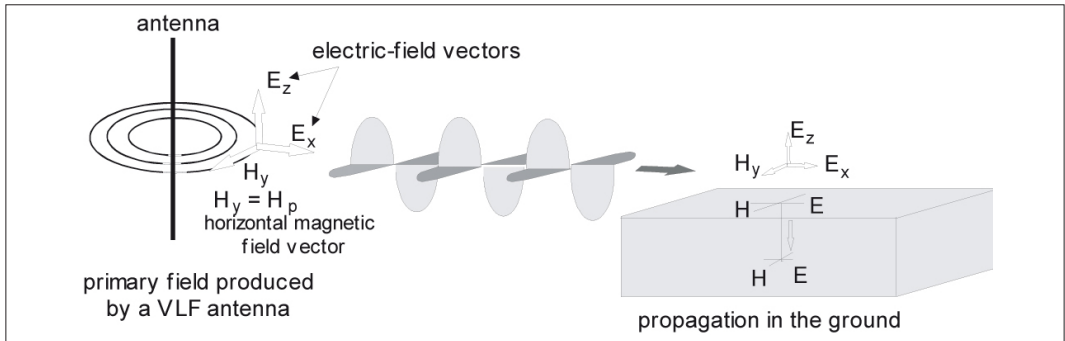
VLF (very low frequency) antennas carry alternating electric current oscillating at frequencies between 15 and 30 kHz, which are used by the military for long-distance communications.

Maxwell's equations show that all oscillating electric currents generate electromagnetic waves, which appear as an electric field and a perpendicular magnetic field of the same frequency (Figure 5.33).

#### *Difficulties with the method*

The principal limitation of the VLF method is its dependence on the primary field. The use of VLF transmission appears to be diminishing (certain transmitters have been shut down) and this method may no longer be operational in a few years time. In addition, the profile directions of VLF measurements are determined by the position of the primary-field-emitting antenna, which can be a severe limitation in the field.

Moreover, the sounding depth of the VLF method is rarely more than 20 metres, and may only be a few metres if the surface layer is highly conducting (clay, saltwater).



**Figure 5.33: Primary electromagnetic field.**

Vector  $E_x$  corresponds to the horizontal component of the primary electric field (same direction as the antenna). Vector  $E_z$  corresponds to the vertical component of the same field. Vector  $H_p$  (or  $H_y$  in a system of  $x, y, z$  co-ordinates) corresponds to the horizontal component of the primary magnetic field (at right-angles to the direction of the antenna).

However, the rapidity of VLF measurements means they are still quite widely used, particularly to measure profiles in fractured media (using ‘Wadi’ equipment), or to map apparent iso-resistivity in sedimentary media (using ‘TVLF’ equipment).

#### *Magnetic field measurements using Wadi equipment*

Originally designed for ore exploration, the Wadi equipment (from the ABEM Company) has been adapted for use in exploration for water, notably in fracture zones, where discontinuities are significant. It does not give useable results in sedimentary zones (sedimentary structures are too laminar and discontinuities insufficiently marked). As with other VLF equipment, the anomaly signal becomes too weak to be measured when argillaceous cover is significant (recorded values are around 0).

When the primary electromagnetic field intersects a target conductor, this conductor creates in turn a secondary electromagnetic field ( $H_s$ ) of the same frequency, but out of phase with the primary field. When the joint effect of the primary and secondary fields is measured (Figure 5.34), the resulting field, instead of oscillating in a linear manner, describes an ellipse (the ‘ellipse of polarisation’).

Measurement devices give:

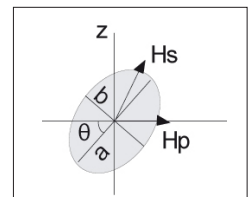
- the ratio  $b:a$  of the minor and major axes of the ellipse (in%), which provides information on the conductivity of the anomaly (defined as the real/imaginary ratio of the Wadi signal).
- the angle  $\theta$  between the horizontal and the major axis of the ellipse of polarisation. The cosine of this angle multiplied by the major axis will give an approximation to the real component, which is used to locate anomalies.

Wadi is essentially used for the location of fractures in lightly-covered bedrock zones, implementing profiles as RP. Compared to electrical methods, implementation is much more rapid, allowing larger exploration zones to be defined.

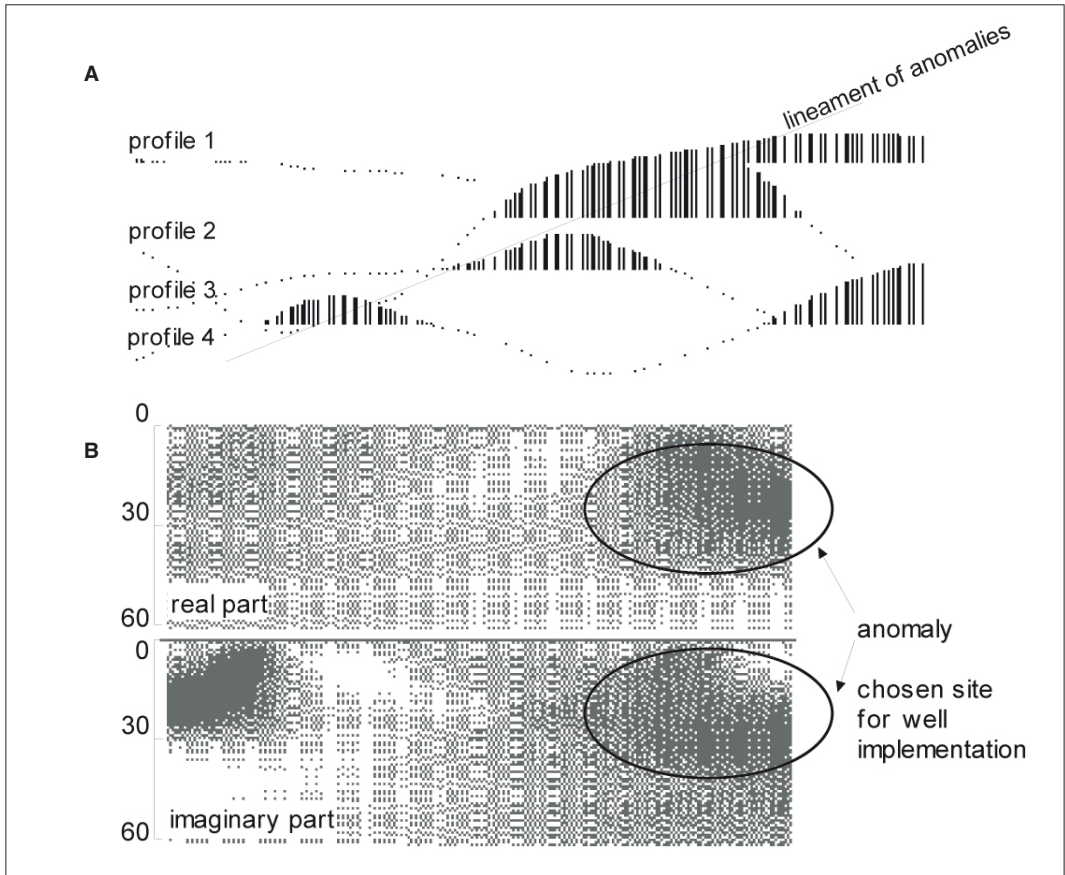
The interpretation software gives information on the depths and shapes of anomalies (Box 5.3). The equipment gives the same information in a more schematic form directly in the field. Whatever the information obtained, it is strongly recommended that VES measurements should be carried out on anomalies to confirm their potential and to specify depths.

An example of well location in Mali using Wadi is shown in Figure 5.35.

**Figure 5.34: Ellipse of polarisation of the field resulting from the interaction between primary and secondary fields.**







**Figure 5.35: Well sunk after Wadi survey (ACF, Mali, 1998).**  
**LS = 10.2 m; depth = 15.2 m. A: multiple profiles Re. B: vertical section.**

#### *Electric-field measurements using TVLF equipment*

The measurement of the horizontal components of the resulting electric ( $E_x$ ) and magnetic ( $H_y$ ) fields allows one to calculate the apparent resistivity of layers traversed, using the relation:

$$\rho_a = \frac{1}{2\pi \cdot \mu_0 \cdot f} \times \frac{E_x^2}{H_y^2}$$

where  $\mu_0$  is the magnetic permeability in vacuum ( $= 4\pi \cdot 10^{-7}$ ) and  $f$  the antenna frequency.

The TVLF (from Iris Instruments) can simultaneously measure  $E_x$  and  $H_y$ , and calculates the apparent resistivity for the antenna frequency used. To measure  $E_x$ , two electrodes planted in the ground at every station are used: if the measurement point is electrode 1, electrode 2 is planted at a distance of 10 m, in line with the direction towards the antenna (and therefore of the profile).  $H_y$  is measured perpendicular to the direction of the profile.

The phase shift between  $E$  and  $H$  is also measured and is represented by the value  $j$ . In homogeneous environments, its value is  $45^\circ$  or  $-135^\circ$  depending on the sense of the profile or the angle of the electrodes. It indicates how the resistivity varies. When  $j < 45^\circ$  (or  $-135^\circ$ ), resistivity increases with depth; conversely, when  $j > 45^\circ$  (or  $-135^\circ$ ), resistivity decreases with depth.

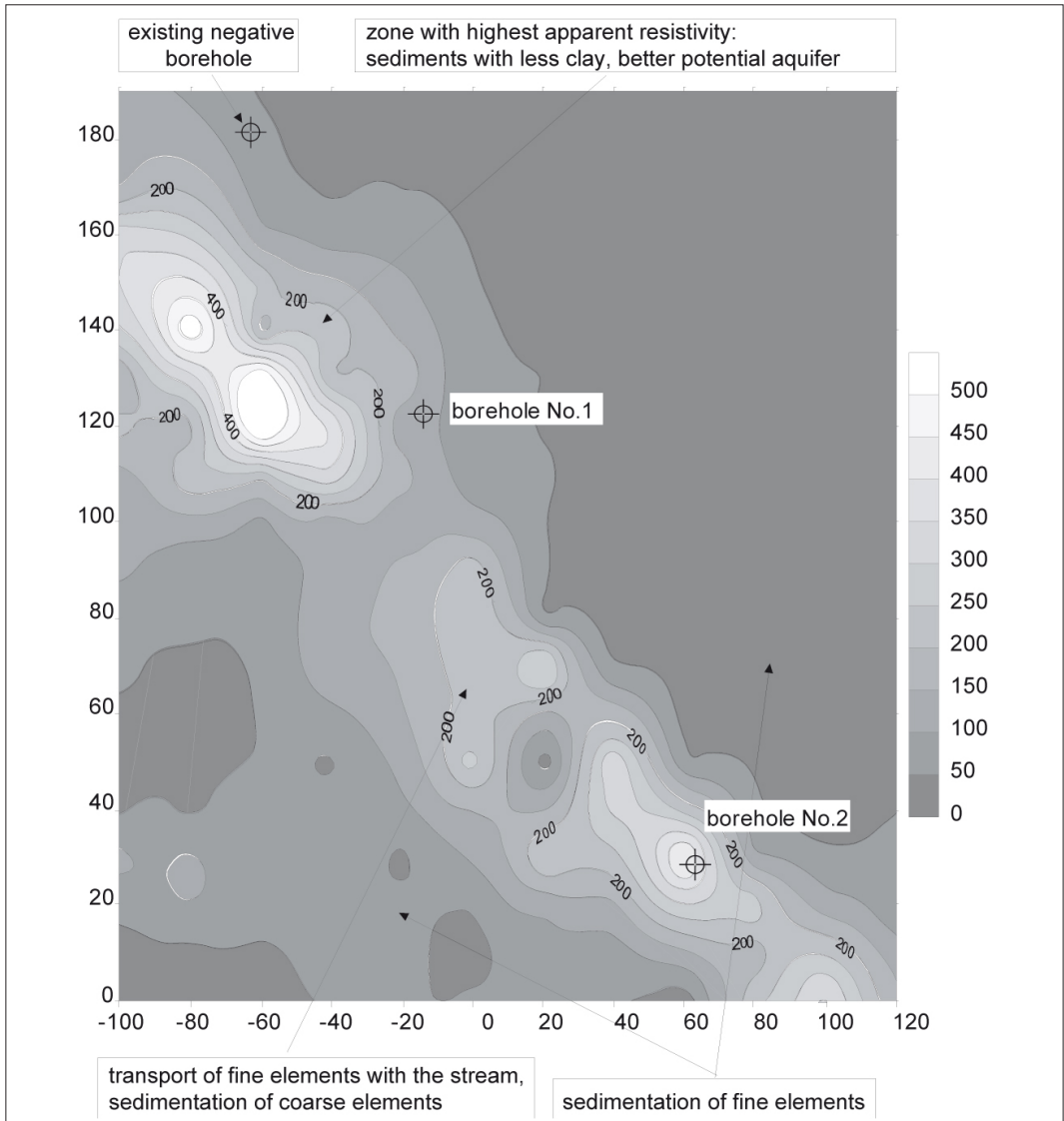


Figure 5.36: Iso-resistivity map (ACF, St André Farm, France, 1995).

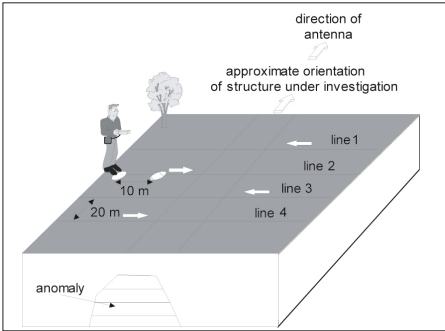
TVLF in the resistive mode is mainly used in sedimentary environments to map variations in apparent resistivity. An example of borehole implementation in alluvial deposits from the farm at St André (France, ACF, 1995) is given in Figure 5.36. Borehole No. 1 was abandoned (formations included silt-sand sediments with gravel passages of widely varying thicknesses, and also including pebbles). Borehole No. 2 revealed the same type of profile (more pebbles), with incoming water at a depth of 44 to 52 m. The old borehole had encountered neither pebbles nor gravel, but much more clayey deposits down to a depth of 60 m. The iso-resistivity map can be interpreted as indicating the presence of an old riverbed, with deposits of coarse elements (pebbles, gravel, sand) where the current was strongest. The deposit of finer elements (silt) occurs at the riverbanks.

## Box 5.3

### Operating the Wadi

The Wadi measures the magnitude of the resultant of the primary and secondary fields, which is transformed into a complex number function with imaginary and real components. The imaginary component is 90° out of phase with the primary field, whereas the real component is in phase with this field.

To be able to detect a conductive anomaly, the primary magnetic field must pass perpendicularly through the anomaly, i.e., the direction of the transmitter is the direction of the anomaly. In other words, the antenna must be perpendicular to the direction of the displacement and parallel to that of the anomaly. It is necessary to take multiple profiles in order to confirm the information (Figure 5.37). It is important to maintain the same measurement direction for a series of profiles, but the direction itself is unimportant.

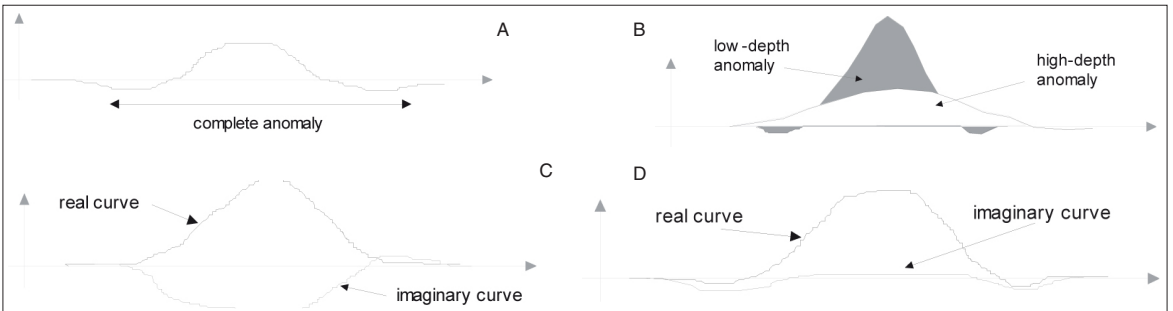


The distance between profiles depends on the width of the anomaly, the area to be covered, and the precision required. A distance of 10 m between each measurement is a good compromise between precision and time taken to make the measurement.

It should be noted that the Abem-Wadi software has its own system of coordinates, and it is therefore recommended that the programmed distances should be maintained, and that the 'north' of the Wadi should be made to correspond to the direction of the initial measurement.

**Figure 5.37: Anomaly/antenna/profile directions, VLF.**

Results can appear in two forms, real or imaginary, each being either filtered or unfiltered. The filtered real curve gives an initial interpretation and indicates the observed anomalies in the field. For a good interpretation (Figure 5.38), the anomaly must be completely covered. The sign (+ or -) of the imaginary curve depends largely on the thickness of surface formations and their conductivity. It is therefore necessary to try to observe the amplitude of the curve rather than the sign.



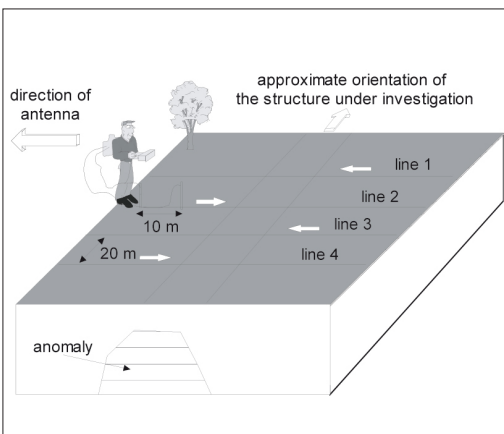
**Figure 5.38: Real and imaginary curves of anomalies detected by Wadi.**

**A:** real curve of an observed anomaly.

**B:** modification of the shape of the real curve according to anomaly depth.

**C:** comparison of real and imaginary curves in the case of an imaginary part of high amplitude indicating an anomaly of high conductivity (saline water, clay etc.).

**D:** comparison of real and imaginary curves in the case of an imaginary part approaching zero which indicates the presence of poorly conductive ground (fracture full of lightly mineralised water).



### Operating the TVLF

A parallel series of profiles oriented in the direction of the antenna is taken perpendicular to the structure of interest. In the absence of any indications as to the direction of structures (no geomorphological clues, outcrops etc.), a pair of profiles is taken using two antennas set at right angles, and the frequency which gives the most information is used.

In all cases, it is preferable to select only one frequency (antenna) per series of measurements. The profile directions must be verified using a compass, and the data must be rigorously entered in the TVLF. For example, to record a 300-m profile, station intervals of 10 m, with 20 m between each profile is suggested (Figure 5.39). If profile no. 1 is defined as LINE = 00100 m, profile no. 2 will be LINE = 00120 m. At the time of data capture, STATION 10 of LINE 00120 will correspond to STATION 290 (300 m profile) of LINE 00100.

**Figure 5.39: TVLF profile in resistivity mode.**

#### 4.3.4 THE SLINGRAM METHOD

This method consists of measuring the ratio of the signal emitted by an transmitter to that detected in a receiver a few metres or tens of metres away (Figure 5.40).

The transmitter and the receiver used by ACF (Geonics EM34) are coils of cable about one metre in diameter. Measurements can be made at 3 frequencies (6.4, 1.6 and 0.4 kHz) corresponding to 3 transmitter-receiver distances ( $a = 10, 20$  and  $40$  m) and using 2 orientations: the horizontal dipole (HD), in which transmitter and receiver are placed vertically in the same plane, and the vertical dipole (VD) with transmitter and receiver horizontal in the same plane.

These various configurations give a variation in the investigation depth from a few metres (HD and  $a = 10$  m) up to a few tens of metres (VD and  $a = 40$  m).

This method can be used to construct profiles of apparent resistivity or maps of apparent iso-resistivity.

Figure 5.41 shows two maps made by ACF in northern Uganda (Gulu), in a weathered, granito-gneiss bedrock zone. The measurements were all performed with the same receiver/transmitter spacing ( $a = 20$  m), but using the two configurations, horizontal dipole (HD) and vertical dipole (VD). These maps clearly reveal the presence (at a depth of about 20 m as measured by VD) of a conducting zone to the East, which probably corresponds to an argillaceous weathered area, whereas the more resistive zone to the West could be an aquifer.

Figure 5.42 corresponds to two profiles made using the EM 34 equipment on the abscissa  $x=0$  of Figure 5.41. On the same graph is also shown an RP recorded using the Wenner configuration with the distance  $AB/2=40$  m. The investigation depths of the RP and the EM34 VD measurements are comparable, and the information furnished by the profiles is similar. But the EM profile acquisition is much quicker (500 m per hour in these conditions compared with 200 m per hour for the RP) and requires only 2 people (1 for the receiver, 1 for the transmitter) compared with 4 for the RP (1 for each electrode)

The Slingram method may be preferable to the RP method at shallow investigation depths (10 to 40 m maximum) when the surface formation is not too conducting. But if this is not the case, the sounding depth is generally too low to reach typical hydrogeological structures of interest. On the other hand, this method is more versatile than VLF (measurements easily made at different depths, no problem of profile orientation etc.) and does not rely, like VLF, on an external transmitter whose signal may be difficult to pick up.

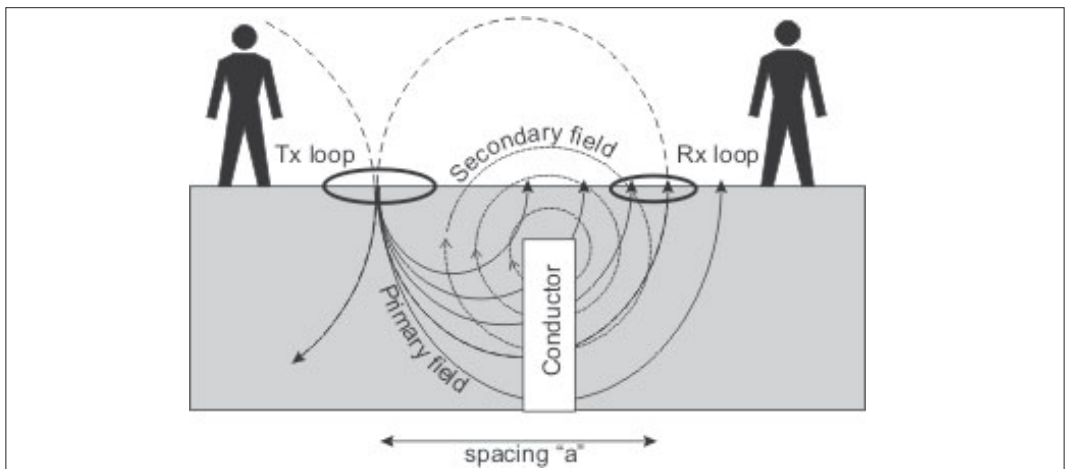


Figure 5.40: Slingram configuration (VD), EM 34.

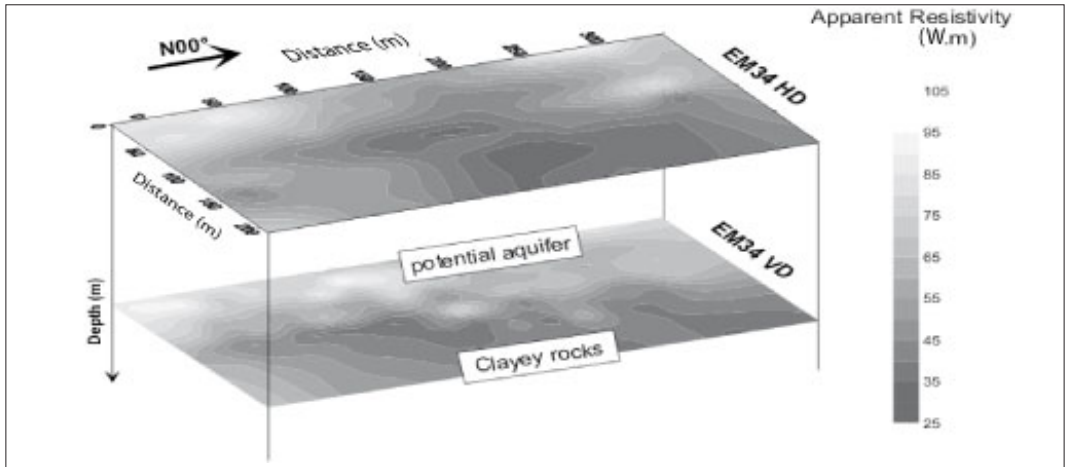


Figure 5.41: Apparent isoresistivity map (ACF, Uganda, 1999).  
EM34 a = 20 m, 20-m steps.

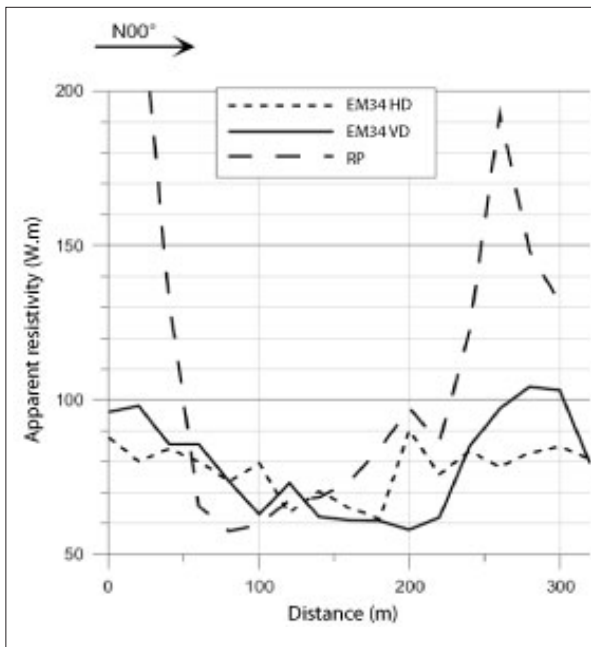


Figure 5.42: Comparison between RP and EM34 profile.  
Profile recorded on the abscissa  $x=0$  of Figure 5.41. EM34 a = 20 m, RP a = 40 m, 20-m steps.

#### 4.3.5 TDEM SOUNDINGS

The TDEM (Time Domain Electro-Magnetism) method is different from the EM methods described above, in that the investigation depth changes with time (rather than with frequency, as in the other methods presented). It is the easiest way in which to perform very deep soundings.

A square loop of electrical cable is usually used as a transmitter (Tx) (Figure 5.43). It is placed on the ground, and its dimensions are chosen to suit the required investigation depth (usually from 40 m on a side for shallow investigations and up to 200 m on a side for deep surveys). A square-wave current (from 1 to 30 A) is passed through the loop; it is cut off suddenly to produce a variation in the

**Figure 5.43: TDEM sounding principle.**

The dashed lines represent the secondary current at different delay times ( $t_1$ ,  $t_2$ ,  $t_3...$ ) after the cut-off of the primary current ( $t_0$ ).

flux of the primary magnetic field, which in turn produces induced currents in the ground (Foucault currents). The amplitude of these induced currents decreases quickly with time. This decrease itself generates another induced current, but at a greater depth. The primary excitation is therefore capable of propagating itself to great depths.

These induced currents generate secondary magnetic fields that can be measured at the surface. As the currents penetrate more deeply with time, measurement of the secondary field at the surface at different times gives information from different depths. The receptor (Rx) is usually a pre-wound multiple loop, a simple loop of cable placed on the ground that could be the same loop as that used previously as Tx.

The injection rate of the primary current is chosen according to the required investigation depth. In practice, measurements start as soon as possible after primary current cut-off in order not to lose the initial information representing the shallow formations.

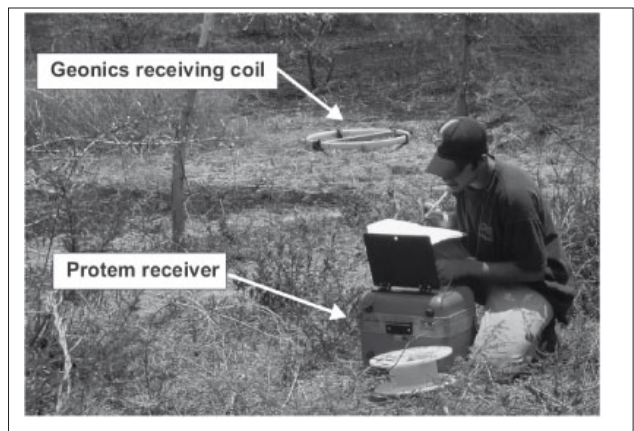
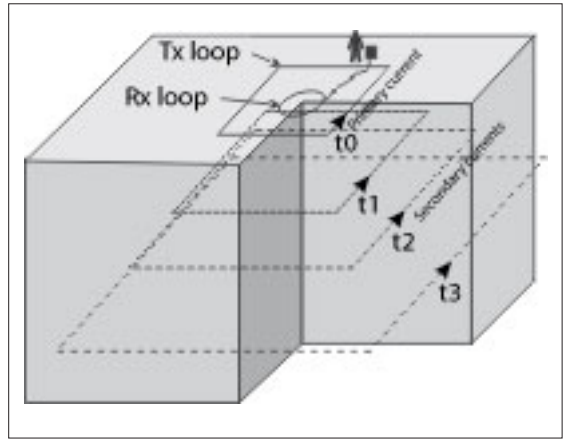
The process is controlled from a transmitter/receiver box that records the set of measurements. The approximate set-up time for a TDEM survey is about 30 minutes for 2 people, and the measurement time is about 15 minutes. The maximum investigation depth ranges from 100 to 300 m, depending on the Tx loop dimensions, the primary current amplitude and the local EM noise level.

Two types of equipment have been used by ACF: the Protém system (from Geonics, Figure 5.44) and the Temfast system (<http://www.aemr.net>). The Protém can be more powerful (1 to 30A depending on the generator) but has a total weight ranging from 50 kg (12V battery as generator) to 100 kg (220V AC generator), while the Temfast produces a primary current of 1 or 4 A, depending on the model, for a total weight of under 10 kg.

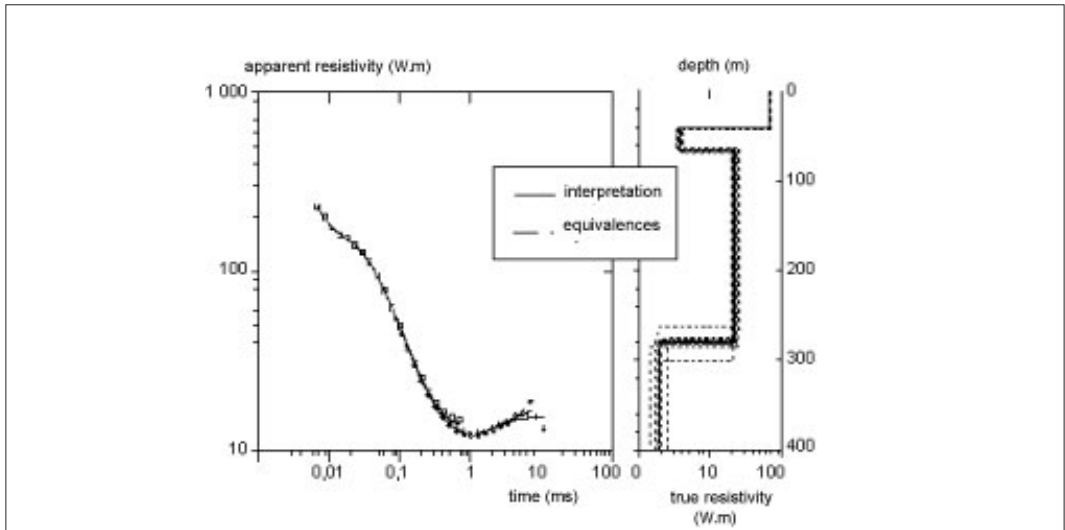
The interpretation of results is performed at the base, using software. The procedure is similar to that used for interpreting electric soundings, and gives families of curves: field records (voltage/time and apparent resistivity/time), and interpreted curves (calculated resistivity/depth and equivalences).

Figure 5.45 shows an example of a TDEM survey carried out by ACF in Cambodia in a clay-sand formation type, using a Tx loop 75 m on each side, and a receiver coil of area 31.4 m<sup>2</sup>. This survey covers four levels, the first of which, 0 to 40 m depth, shows the highest resistance (= 80 Ωm) and could be water-bearing, whereas the others are very conductive and are probably argillaceous (20 to 2 Ωm).

**Figure 5.44: Protém equipment (ACF, Honduras, 2000).**







**Figure 5.45: Example of TDEM sounding (ACF, Cambodia, 1998).**

This example clearly illustrates the advantages and disadvantages of the method in the configuration used by ACF. It is fast and easy to carry out and can provide fairly deep soundings (with no pegs to plant or cable to deploy), and it gives better resolution in conductive formations than DC methods. However, TDEM does not distinguish the uppermost level because primary signal cut-off times, even when very short, do not allow measurements of the induced field to begin instantaneously. In Figure 5.45, for example, the first layer analysed is 40-m thick with a resistivity of 80  $\Omega\text{m}$ , but is in fact composed of different levels. The use of a smaller transmitter loop allows the primary signal cut-off time to be reduced, and therefore to begin measurements earlier, but even then it is not possible to obtain a detailed image of the first 5 to 10 m. TDEM does not work well in resistant environments, in which little or no induction occurs.

## 4.4 Magnetic Resonance Sounding

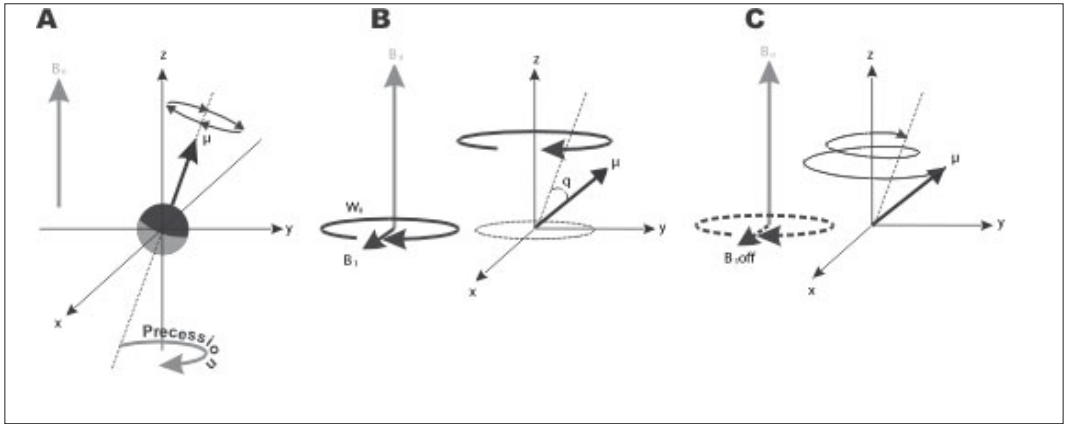
The main advantage of the Magnetic Resonance Sounding (MRS) method, compared to other geophysical methods for groundwater prospecting, is that the measured signal is from groundwater molecules: this reduces the degree of ambiguity in interpreting the data, since any measured signal proves the presence of groundwater.

Developed in the early eighties in Russia, MRS initially provided only the geometry and the water content of water-saturated layers. From 1999 to 2003, ACF conducted a research programme on MRS, in collaboration with various partners, showing that it is also possible to estimate the storativity and transmissivity of aquifers from MRS records calibrated using hydrogeological data.

ACF considers MRS now to be a very useful (and specific) tool for characterising the saturated zones of aquifers.

### 4.4.1 PRINCIPLE OF THE METHOD

It is known from nuclear physics that the hydrogen nucleus (proton) possesses an angular momentum and a magnetic moment  $\mu$ . In a homogeneous magnetic field  $B_0$  (such as the earth's geomagnetic field) the proton acts as a magnetic dipole and experiences a torsional moment that attempts to align it with the direction of the field. Therefore the angular momentum of the proton causes a precessional motion of  $\mu$  around  $B_0$  with an angular velocity  $\omega_0$  known as the Larmor frequency (Figure 5.46A).



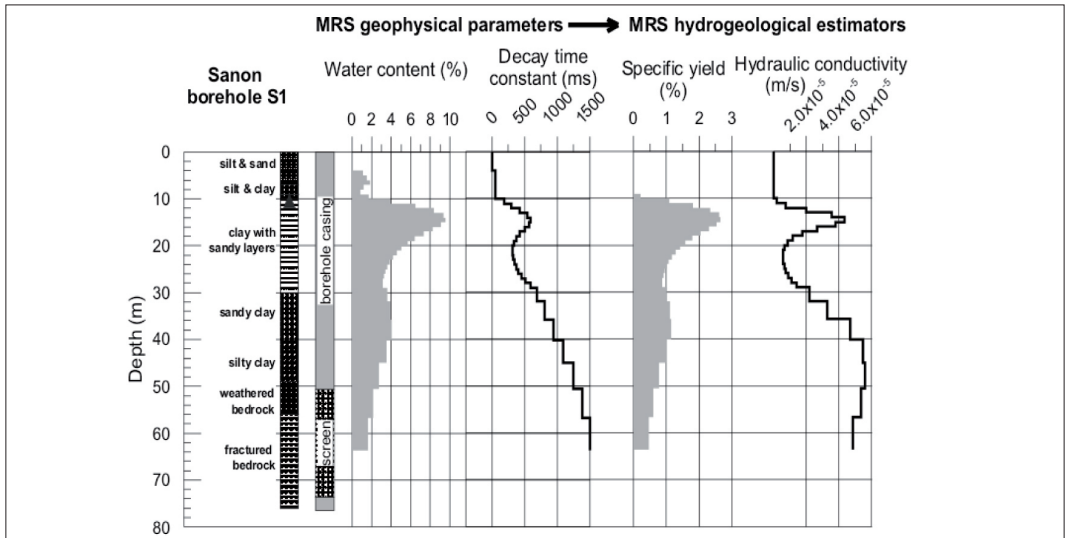
**Figure 5.46: MRS principle.**

**A:** hydrogen nucleus's precessional motion around the static field  $B_0$ . **B:** hydrogen nucleus excitation by an oscillating field  $B_1$ . **C:** hydrogen nucleus relaxation.

To carry out a sounding, an energizing field  $B_1$  is created in a transmitter loop by a pulse of current oscillating at the Larmor frequency. At resonance, i.e. when the energizing frequency is the local Larmor frequency, an interaction between the nuclear angular momentum and the excitation field  $B_1$  occurs, which deflects the magnetic moment  $\mu$  from its equilibrium position (Figure 5.46B).

When the excitation field  $B_1$  is cut off, the magnetic moment goes back to its equilibrium position, sending out a magnetic resonance signal, which is detected by a receiver loop (Figure 5.46C). This signal has an exponential envelope decaying with time (Box 5.4). Three types of information can be obtained from this relaxation signal:

- its initial amplitude is directly related to the number of hydrogen nuclei and therefore to the quantity of groundwater;



**Figure 5.47: MRS geophysical parameters (the presented decay time is  $T_1$ , see Box 5.4) and hydrogeological indicators, example of Sanon S1 Borehole in Burkina Faso, weathered granite (ACF, 2002).**



- the time decay constant of the relaxation signal is related to the mean size of water-containing pores, and therefore to porosity;
- the phase shift between the relaxation signal and the excitation current is linked to the ground resistivity.

After interpretation of MRS field data, two geophysical parameters are obtained: the variation of the water content and of the decay time with depth (Figure 5.47). If a calibration process is performed, i.e., if some MRS measurements are performed around boreholes with known lithology and pumping-test results, two hydrogeological estimators can be obtained from the geophysical parameters: the aquifer's local storativity and transmissivity.

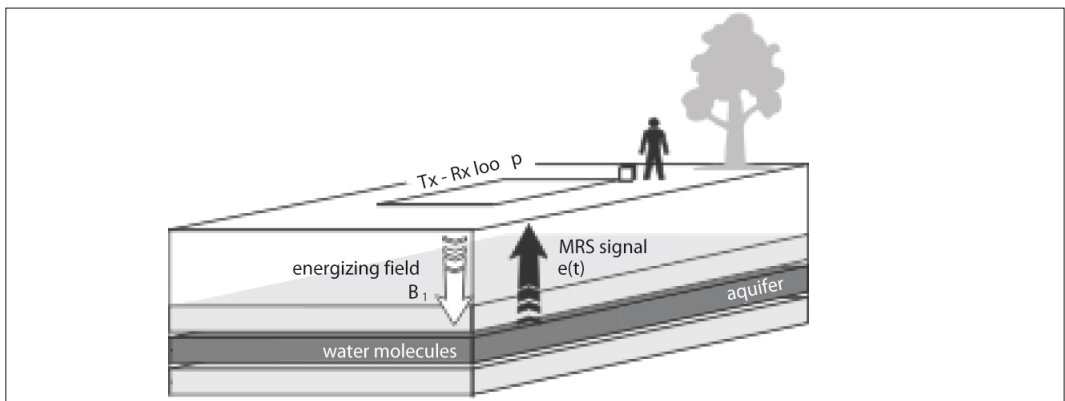
#### 4.4.2 PERFORMING MEASUREMENTS

To generate the excitation pulses, an electric wire loop is placed on the ground and is energized by a pulse of alternating current at the Larmor frequency (Figure 5.48). The Larmor frequency depends on the local geomagnetic field amplitude (Box 5.4) which needs to be measured at the sounding location using a common proton magnetometer (Figure 5.49A). Figure 5.50 shows the theoretical Larmor frequency calculated for the year 2002 at sea level.

To carry out a sounding, i.e. to perform measurements at various depths, the amplitude of the excitation current is increased: the higher its amplitude (the current intensity), the greater the sounding depth. Sixteen depth steps are used in a typical sounding. When the excitation pulse is switched off, the magnetic resonance signal is recorded through the same loop for each depth step. The only commercial MRS equipment available is the Numis range (from Iris Instruments, Figure 5.50B). The model used by ACF for hydrogeological purposes is the powerful system called Numis Plus. It is driven by a laptop computer, which commands both the excitation and the recording sequences.

The Tx/Rx loop is typically square in shape (easy to set up in the field) with a side length of between 40 and 150 m. At a given location, this length determines the maximum depth of investigation, which is in fact roughly equal to the side length.

The implementation time for an MRS measurement depends mainly on the local signal to noise ratio: it was about 1 hour in Cambodia (non-consolidated sediments) and but around 20 hours in Burkina Faso (weathered granite). The total weight of the equipment used is about 350 kg, so that a vehicle is required for transportation. A team of 4 people is the most convenient, 2 unskilled workers, 1 field geologist to direct the setting up of the loop and 1 hydro-geophysicist to manage the whole MRS process. ACF's experience is that a local team can be trained to implement standard MRS independently in about 1 month.



**Figure 5.48: Schematic diagram of MRS measurement array.**



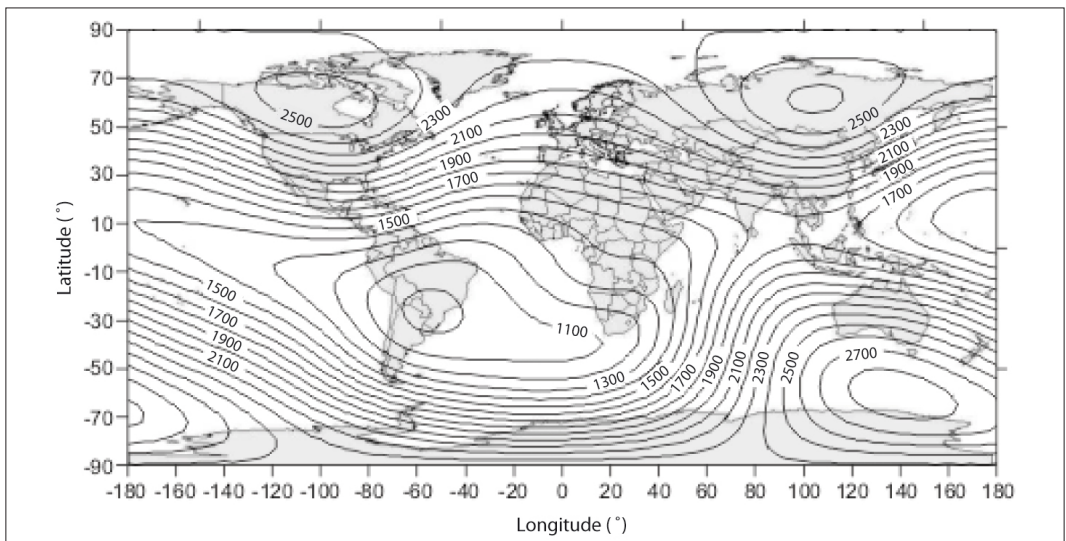
**Figure 5.49: MRS equipment.**

**A: geomagnetic field measurement using a proton magnetometer. B: Numis Plus equipment, ACF 2002.**

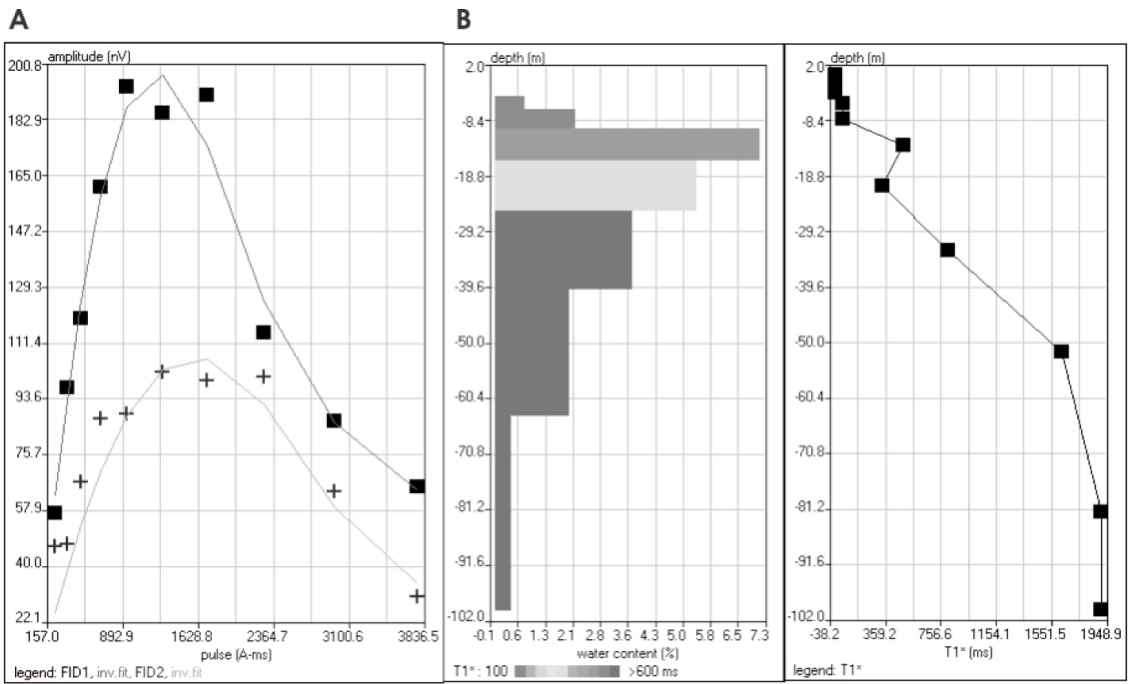
#### 4.4.3 INTERPRETATION

At the end of the data-gathering period, it takes only a few seconds to interpret the records directly on site using inversion software included in the equipment package (Samovar). The main curves obtained are:

- the sounding curve, which is the initial amplitude of the relaxation signal as a function of the pulse moment (i.e., depth step, see Box 5.4). This gives, in qualitative terms, the amount of groundwater as a function of pseudo-depth (Figure 5.51A);
- field record curves, which help to check the records' quality and the quality of the model fit;
- geophysical interpretation curves, showing the water-content and the relaxation decay time as a function of depth (Figure 5.51B).



**Figure 5.50: Theoretical Larmor frequency, year 2002 at sea level.**



**Figure 5.51: MRS curves.**

**A: field records (raw data). B: geophysical interpretation curves, example of Sanon S1 Borehole in Burkina Faso, weathered granite (ACF 2002).**

If a calibration process is performed, hydrogeological estimators can be obtained from geophysical parameters, i.e., the local storativity and transmissivity of the aquifer (Figure 5.47).

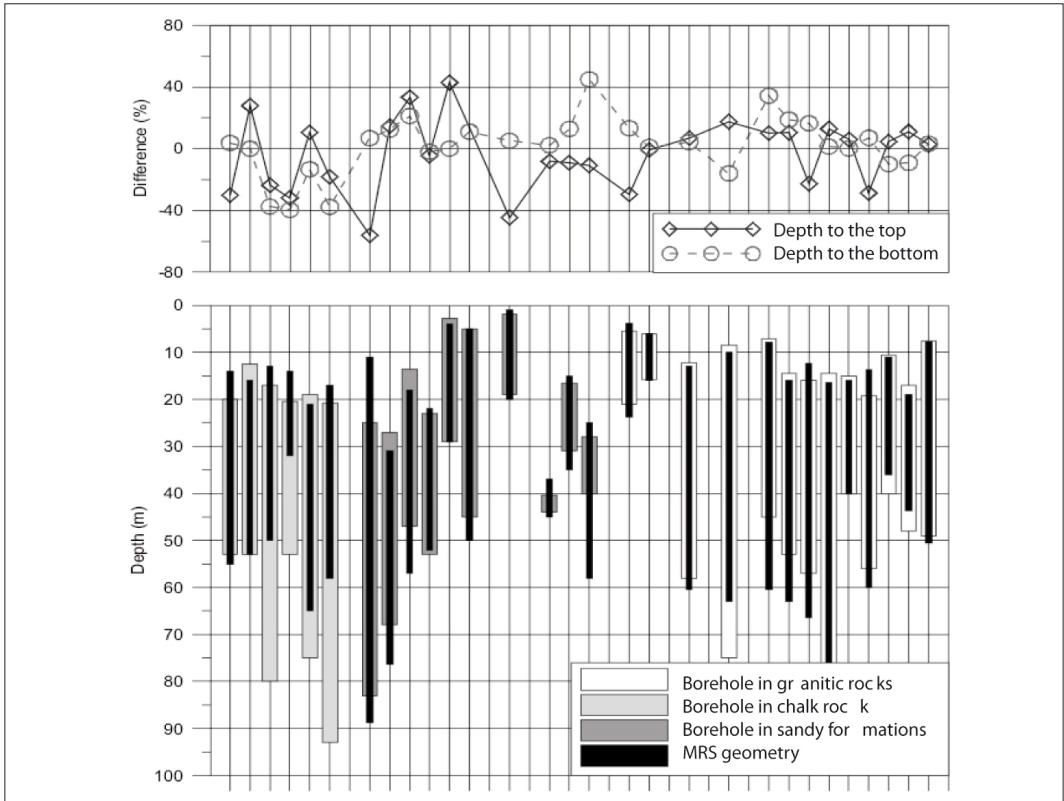
ACF has evaluated the quality of aquifer characterisation by MRS in several geological contexts. The MRS-measured saturated-reservoir geometry, storativity and transmissivity have been compared to those obtained from boreholes and pumping tests. The main results are presented below.

#### *Saturated-reservoir geometry*

Figure 5.52 compares the one-dimensional geometry of saturated reservoirs estimated from MRS with the geometry estimated from the borehole lithology. The location of the top of the saturated reservoir is estimated by MRS with an average difference of 24%, i.e. 3.9 m, from that given by the borehole, and the bottom of aquifer is estimated with an average difference of 13%, i.e. 11.4 m. These results show that MRS gives a sufficiently accurate picture of the geometry of the saturated zone, but cannot replace genuine piezometers. In fact, MRS does not give any information about static levels, only about the depths of the saturated zones: the two are equivalent in unconfined aquifers, but are of course different in confined aquifers.

#### *Geophysical parameters: water content and relaxation time*

By comparison with the total porosity, the MRS water content is defined as  $w = V_{\text{long}}/V_{\text{total}} \cdot 100$ , where  $V_{\text{long}}$  is the volume of water with sufficiently long relaxation constant ( $T_2^*$ , see box 5.4), and  $V_{\text{total}}$  is the total volume of the sample. The MRS water content differs from the total porosity of saturated media because the relaxation effect can make the MRS signal too short for the equipment to detect (currently the instrumental ‘dead time’ is 40 ms). Because the relaxation time is longer for flowing water (some tens to thousands of ms) than for non-flowing water (some units to tens of ms), the MRS water content is a rough estimation of the aquifer’s kinematic porosity.



**Figure 5.52: Comparison between saturated reservoir geometry as estimated from MRS and from boreholes.**

Two decay-time constants can be estimated from MRS records (Box 5.4). ACF's experience is that  $T_1$  is the more useful for hydrogeological purposes and should be estimated.  $T_1$  is linked to the mean size of the pores containing water: the larger the mean pore size, the longer  $T_1$ .

*Hydrogeological parameters: storativity, permeability (hydraulic conductivity) and transmissivity estimators*

The water content  $w(z)$  and the relaxation time  $T_1(z)$  derived from MRS records can be used to estimate the storativity  $S$ , the hydraulic conductivity  $K$  and the transmissivity  $T$  of aquifers:

- In confined aquifers, the storativity can be represented by the storage coefficient:

$$S_{MRS} = (w \cdot \Delta z) \cdot C_1.$$

- In unconfined aquifers, the storativity is almost exactly equal to the specific yield, represented by  $n_{eMRS} = w \cdot C_2$ .

- The hydraulic conductivity can be estimated as  $K_{MRS} = C' \cdot w(z) \cdot T_1^2(z)$ .

- The transmissivity is therefore calculated as:

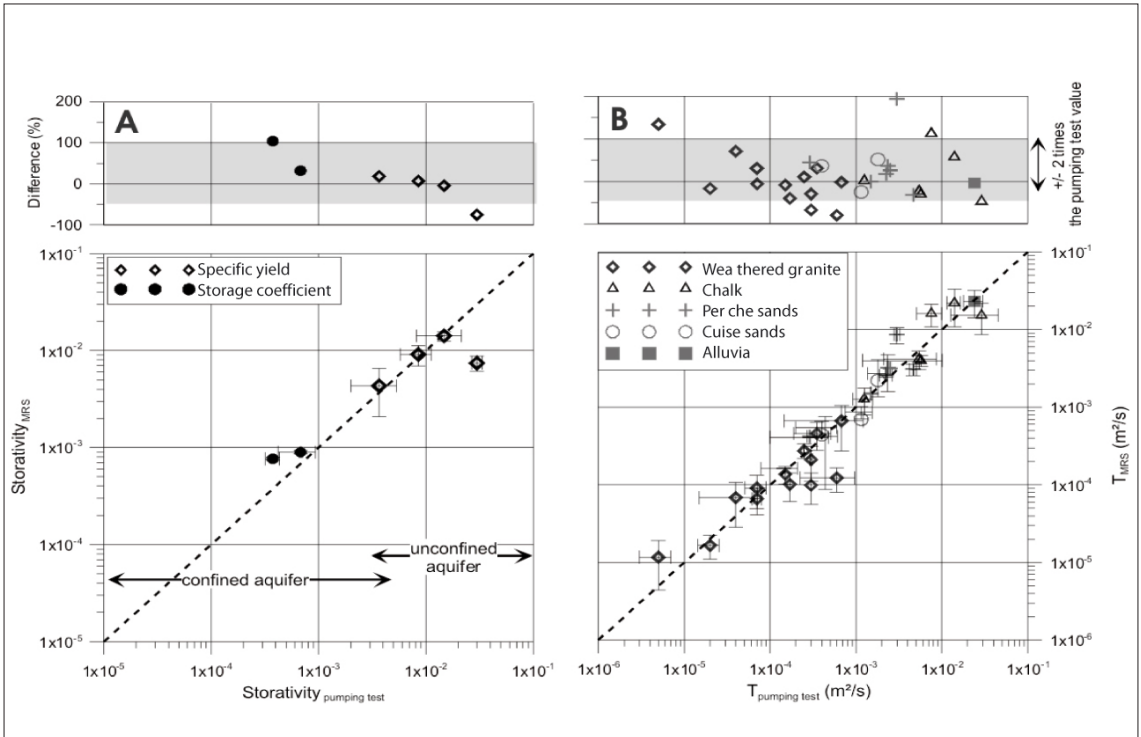
$$T_{MRS} = \int_{\Delta z} K_{MRS}(z) \cdot dz$$

where  $w$  is the MRS water content,  $T_1$  the MRS longitudinal decay constant,  $\Delta z$  the aquifer thickness and  $C_1$ ,  $C_2$  and  $C'$  empirical constants that need to be determined from pumping-test data.

Some empirical constant values are proposed by ACF, but new calibrations need to be performed for new geological contexts and site locations (Table 5.IX and Figure 5.53).

**Table 5.IX: Empirical constants used for MRS hydrogeological estimator calibration.**

	C1	C2	C'
Weathered granite in Burkina Faso	$4.3 \cdot 10^{-2}$	0.28	$1.3 \cdot 10^{-9}$
Unconsolidated sediments (silt, sand, gravel) in France			$4.9 \cdot 10^{-9}$
Chalk in France			$3.5 \cdot 10^{-8}$



**Figure 5.53: MRS hydrogeological estimators. A: storativity estimators for weathered granite in Burkina Faso. B: transmissivity estimator.**

The transmissivity estimator is fairly robust – it gives an estimate of the productivity that is equal, within a factor of 2, to the value given by the test pumping in 75% of cases. In addition, its range of transmissivity values is wide, corresponding to outputs from a few hundred litres per hour ( $T = 10^{-6} \text{ m}^2/\text{s}$ ) to several hundred cubic metres per hour ( $T = 0.1 \text{ m}^2/\text{s}$ ).

The storativity estimators require further confirmation (insufficient calibration data) and are more difficult to use, since one needs to know *a priori* whether the aquifer is confined or unconfined in order to use the correct estimator (specific yield or storage coefficient).

*Qualitative analysis: permeability and transmissivity estimators*

If the calibration process cannot be carried out, either because the geological context is obviously not one-dimensional at the observed scale, or because no pumping-test data are available, a qualitative approach using two estimators can still be used to characterize the groundwater.

A permeability estimator can be calculated as:

$$k_x(z) = \frac{w_x(z) \cdot T_{lx}^2(z)}{w_r(z) \cdot T_{lr}^2(z)}$$

A transmissivity estimator can be calculated as:

$$T_x = \frac{\int_{\Delta z} w_x(z) \cdot T_{lx}^2(z) \cdot dz}{\int_{\Delta z} w_r(z) \cdot T_{lr}^2(z) \cdot dz}$$

where x and r are two of n MRS stations (1, x, r, n). The reference station r can be selected so that  $k_{x\max}(z) \leq 1$  or  $T_{x\max} \leq 1$  for all soundings ( $x = 1$  to  $x = n$ ).

The estimators  $k_x$  (k-estimator) and  $T_x$  (T-estimator), which are normalized estimators for the permeability and the transmissivity, can be used as contrast indicators to compare several (n) soundings. An example of such a qualitative approach is presented in Chapter 5B.

#### *Principal limiting factors in MRS*

Like all geophysical methods, MRS has various limitations:

– *Equivalences*: two models are equivalent when they give the same signal. In MRS, layers 1 and 2 are equivalent if the product of saturated thickness and water concentration are similar in both. In other words, one cannot determine at the same time both the water concentration and the saturated layer thickness.

– *Resolution and probing depth*: the resolution is the capacity of the method to detect and characterise a saturated level. It is a function of various factors, including principally the intensity, the tilt angle of the geomagnetic field, the electrical resistivity of the formation and the size of the Tx-Rx loop used. Taking the example of a small reservoir, equivalent to a 1-m thick layer of pure water, i.e. a 6.5-m thick layer of fine sand with 15% kinematic porosity, or – a geologically equivalent model – a water-filled cylindrical pipe 10 m in diameter, crossing a Tx-Rx loop with 100-m sides. In the most unfavourable conditions (close to the magnetic equator and on conducting ground) this aquifer could be detected by MRS down to a depth equivalent to 40% of the diameter of the Tx-Rx loop. In the most favourable conditions (close to the magnetic poles and on insulating ground) this same aquifer could be detected down to a depth equivalent to 150% of the diameter of the Tx-Rx loop. However, detection and characterisation are not the same thing: the errors in the estimate of the water concentration and the thickness of the saturated zone can be large, even at small depths, but the error in the estimate of their product (equivalence) is less than 5% for depths equivalent to half the size of Tx-Rx loop and 15% beyond that depth. In the context of ACF programmes, this means that it is generally possible to detect saturated levels down to depths of about 100 m, and to characterise them properly down to about 70 m.

– *Sensitivity and one-dimensional nature*: the maximum volume integrated in an MRS measurement is given approximately by a circular area of diameter 1.5 times that of the Tx-Rx loop multiplied by a depth equal to the loop diameter. For a 100-m diameter loop, this volume is roughly 1.8 million m<sup>3</sup>. The fact that the signal is integrated over this volume means of course that the method cannot reveal any heterogeneity inside such a volume, nor can it detect signals generated by small numbers of hydrogen nuclei.

– *Suppression*: when the volume of water is very small compared to the volume explored by the sounding, the signal is too weak to be measured: this is known as suppression. It can occur in fractured media or in dissolution patterns, which contain only small volumes of water but which are nevertheless highly productive.



**Box 5.4**  
**Principle of MRS.**

The hydrogen nucleus, i.e. a proton, possesses an angular momentum  $S$  and a magnetic moment  $\mu$ . The two quantities are related through the expression  $\mu = \gamma \cdot S$ , where the gyromagnetic ratio  $\gamma$  is a constant characteristic of the hydrogen nucleus. In a homogeneous magnetic field  $B_0$ , the angular momentum of the proton causes a precessional motion of  $\mu$  around  $B_0$  with an angular velocity known as the Larmor frequency  $\omega_0 = \gamma B_0 / 2\pi$ .

To meet the resonance condition, an energizing field  $B_1$  of frequency equal to the local Larmor frequency is created in a transmitter loop by a pulse of alternating current  $i(t) = I_0 \cos(\omega_0 t)$ ,  $0 < t \leq \tau$ , where  $I_0$  and  $\tau$  are respectively the pulse amplitude and duration. Therefore, an interaction between the nuclear angular momentum and the excitation field  $B_1$  occurs, deflecting the magnetic moment  $\mu$  from its equilibrium position.

When the excitation field  $B_1$  is cut off, the magnetic moment goes back to its equilibrium position, sending out a relaxation signal, which is recorded in a receiver loop. This signal oscillates at the Larmor frequency and has an exponential envelope decaying with time, which can be approximated by (Figure 5.54A):

$$e(t,q) = E_0(q) \exp(-t/T_2^*(q)) \cos(\omega_0 t + \phi_0(q)) \tag{1}$$

where  $q = I_0 \tau$  is the energising pulse parameter,  $\phi_0$  is the phase,  $T_2^*$  is the signal decay time (called the transverse relaxation time in the usual terminology) and  $E_0(q)$  is the initial signal amplitude:

$$E_0(q) = \omega_0 M_0 \int_{\mathcal{V}} B_{1\perp} \sin(1/2 \gamma_p B_{1\perp} q) w(r) dV(r) \tag{2}$$

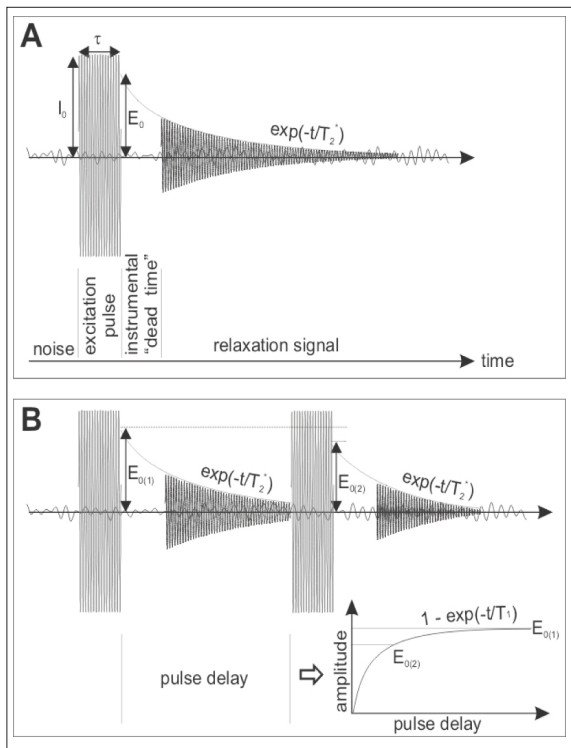
where  $M_0$  is the nuclear magnetisation for the protons,  $B_{1\perp}$  is the primary magnetic field component (normalised to 1A) perpendicular to the static field  $B_0$ ,  $r$  is the co-ordinate vector and  $w(r)$  the water content.

From equations (1) and (2) it can be understood that:

- The initial amplitude of the signal  $E_0$  is related to the water content  $w(r)$ . Solving equation (2) leads to a direct estimate of the water content of the investigated volume.
- The spatial contribution of the signal is determined by  $q$ , i.e. the depth of investigation is controlled by the pulse intensity  $I_0$  (maintaining the pulse duration constant).
- The signal decays with time at a rate governed by  $T_2^*$ . This constant is linked to the mean water-containing pore size, but it is also influenced by local inhomogeneities in the static field, often induced by the magnetic properties of rocks.

To access a more reliable parameter linked to the pore size, a modified excitation sequence using two pulses, known as saturation recovery, can be used (Figure 5.54B). It gives an estimate of  $T_1$ , (usually called the longitudinal relaxation time), which is linked to the mean pore size of the aquifer:  $T_1 = V_p / \rho \cdot S_p$ , where  $V_p$  and  $S_p$  are the volume and surface area of the pore, and  $\rho$  the surface relaxivity of the rocks.

When the excitation pulse is switched off, the magnetic resonance signal is recorded through the antenna for each pulse  $q$ . Assuming a horizontal stratification, a modified form of equations (1) and (2) is used to convert the recorded quantities  $E_0(q)$  and  $T_2^*(q)$  into water content  $w(z)$  and decay times  $T_2^*(z)$  and  $T_1(z)$  as a function of depth.



**Figure 5.54: Time sequence of the MRS signal.**

- A: single-pulse sequence (estimation of  $T_2^*$ ).**
- B: two-pulse sequence (estimation of  $T_1$ ).**

– *Magnetic rocks*: current MRS equipment measures a macroscopic signal, which is the sum of the signals emitted by each hydrogen nucleus. When the geomagnetic field is heterogeneous on the scale of the sounding, the hydrogen nuclei have different Larmor frequencies, and this generates phase differences between the individual signals, which can reduce the measured time constant sufficiently to prevent the measurement of the resultant signal. ACF was thus unable to measure MRS signals in very productive reservoirs in Honduras (2000), since the magnetic properties of the volcanic rocks present greatly perturbed the geomagnetic field. One should therefore estimate the feasibility of the measurements before carrying out the sounding (variations in the measured field at the surface, magnetic susceptibility of outcrops and stability of the Larmor frequency).

## 5 Prospecting procedures

The sequence of investigation proceeds as a dynamic process that allows the hypotheses advanced on the basis of the results obtained to be tested. It is also at this stage that deeper investigation into the water resource begins.

### 5.1 Exploration boreholes

An exploration borehole verifies hypotheses and furnishes information essential for tasks such as checking VES interpretations and calibrating MRS hydrogeological estimators. It also facilitates logging and pumping tests.

Every result is used as a source of information: a dry borehole must be “used” in the same way as one that produces water, since the reasoning that led to sinking the borehole must be reviewed or developed. The feedback between the previously-envisaged presence of water and the results obtained increases the accuracy of the overall picture.

### 5.2 Assessment of the resource

Pumping tests help to estimate the potential of the boreholes (well tests), and the hydraulic characteristics of the aquifers (aquifer tests, see Chapter 6). At this stage it becomes possible to draw a map of zones of potential groundwater based on the parameters (transmissivity and storativity) obtained from both the pumping tests and the MRS.

Piezometric monitoring must also be implemented at this stage. It acts as a check on the development of resources that are the object of new exploitation, and gives an estimate of seasonal variations. A sketch of the piezometric map can be drawn in order to visualise groundwater flows. This monitoring can be carried out at the same time as measuring water quality (see Chapter 4).

The groundwater chemistry survey can also reveal a great deal about the water-flow system, as well as the relationships between different aquifers, recharge mechanisms and links between groundwater and surface-water bodies (see Chapter 4).

Finally, bases for the construction of a hydrological balance can also be created: rainfall and piezometric monitoring measurements, surface flow-rate studies, and determination of the survey catchment basin should be carried out.

### 5.3 Storage of results and analytical tools

To avoid significant information loss when key staff change, and also to capitalise on the experience gained by staff and share information in the most effective way, it is essential to archive results in a relatively standardised manner. Furthermore, proper storage ensures that information is managed with more care.

ACF has developed tools for managing and analysing hydrogeological information. This process is in constant evolution and the main tools shown in Table 5.X are only a guide.



**Table 5.X: Tools for managing and analysing hydrogeological information.**

Existing documentation	Technical libraries of reference material on various subjects in Paris and Madrid Reports and programme descriptions archived at various sites ACF technical experience collected in the form of manuals and specific reports
Geological maps	Geological map base available at the Paris office of ACF, showing most countries where the agency works, generally at small scales
Well-test and aquifer-test Interpretation software	WHI AquiferTest_Pro software tested and recommended (from Waterloo Hydrogeologic Inc.)
VES and RP Package	Developed by ACF, contains land measurements, maps of presentation of results and sets of Cagniard nomograms IPI2Win freeware included for VES interpretation and results presentation
Interpretation software for geophysical surveys	IPI2Win freeware for interpretation and visualisation of VES recommended QWSEL® software also available for VES interpretation X2IPI freeware recommended for ERI protocol construction and ERI data processing RES2DINV software recommended for ERI data interpretation
Database and geographical information system	Models carried out using Excel® software (limited amounts of data, good system user-friendliness) Mapinfo® software for geographical analyses (thematic map)
Equipment kit	Set of materials and equipment tested and developed by ACF: Ωmega resistivity-meter, electrical-probe logging, drilling rigs, pumping-test kit (see Chapter 6)

## 5.4 Prospecting procedures

To decide the best prospecting procedure to use, all the elements presented in this chapter should be considered, including: what are the hydrogeological questions? which methods and tools will best answer them? how to compare the usefulness of the various possible techniques?

Each context is of course unique, but, using the example of an ACF project in Mozambique, this section illustrates how to set about finding the best procedure to apply when prospecting for underground water.

### 5.4.1 HYDROGEOLOGICAL QUESTIONS

ACF ran a programme to set up a drinking water supply in the Sofala province of Mozambique from 1994 to 2001. By December 2000, 178 water points had been constructed (143 boreholes and 35 wells) with an average success rate of 44.5%. The high number of negative boreholes includes constructions which were dry or whose output was insufficient ( $Q < 500$  l/h), but also boreholes whose water was too mineralised for human consumption (12% of the boreholes).

A study was performed from October to December 2000, with the aim of improving knowledge of the aquifers, in order develop a prospecting method that might increase the borehole success rate.

*The general context of the study: collating available information, and additional investigations*

The districts of Caia and Chemba are in the northern part of Sofala province, on the west bank of the Zambezi River (Figure 5.55).

The region is in the sedimentary basin 'Nord of Save'. The 'Sena' geological formations date from the upper Cretaceous and are composed of continental sandstone up to 2 500m thick (information from Mozambique's National Directorate for Water Affairs, Figure 5.56). Sandstone samples prepared by ACF in the form of thin slices reveal a siliceous formation containing calcic cement, with little or no porosity. This observation is confirmed by the high failure rate of boreholes sunk in the sandstone.

**Figure 5.55: Location of the study zone in Mozambique.**

The region is traversed by temporary rivers flowing from west/south-west to east/north-east; its eastern limit is the Zambezi river. Analysis of the information from ACF's borehole drilling programs shows that the sediments deposited by these surface waters constitute reservoirs of highly variable quality. The Zambezi's alluvia are clayey in some places, but generally provide lightly mineralised water; the sediments deposited by the temporary rivers are coarser but can contain highly mineral-rich water in the north, while in the south they are less permeable and the water is often less highly mineralised.

Samples of the water in the region (rainwater, surface water and groundwater) were collected by ACF, and analyses of the major ions were performed. The interpretation of these analyses shows that the high mineral levels in the groundwater (electrical conductivity in the range 1 500 to 9 000  $\mu\text{S}/\text{cm}$ ) are due to the dissolution by the infiltration water of recently formed minerals present in the superficial horizons. This interpretation is confirmed by the observation *in situ* of carbonated precipitates in superficial cracks in the sandstone, and by the presence of halite in the dead zones of the temporary rivers where water loss by evaporation is intense.

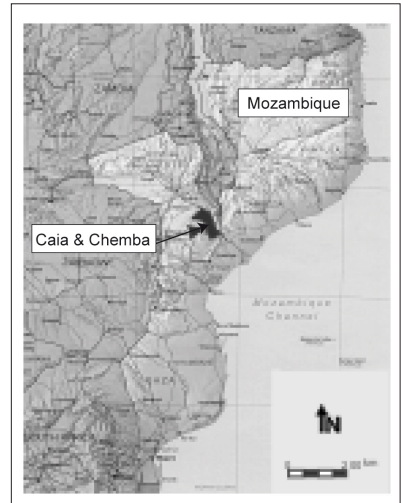
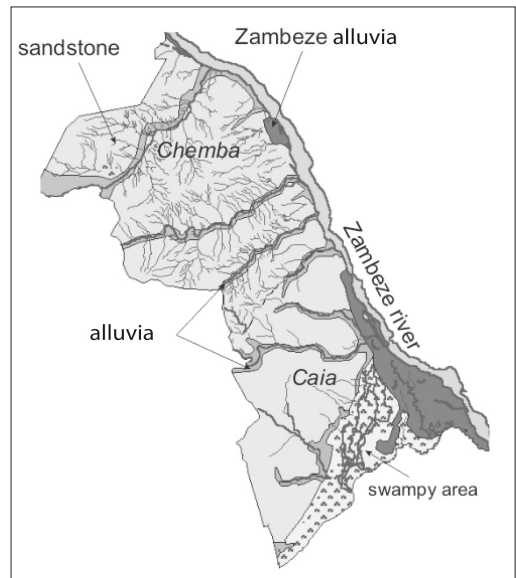
The hydrological balances measured by ACF, using data collected from local partners, are also in agreement with the observations above. They indicate that the northern zone is subject to high rates of evapotranspiration, which explains why the underground water there is highly mineralised (Table 5.XI).

It was not possible to measure the surface run-off, and therefore the fraction of effective infiltration in the total run-off could not be estimated. However, it seems, from the (admittedly incomplete) information available, that the use of low-output (handpump) systems does not significantly affect the replenishment of the water resources, since no borehole ran dry and no excessive drop in the static levels was reported in the period from 1994 to 2000.

According to the results of an exhaustive study carried out by ACF in 1999 and 2000, the districts of Caia and Chemba have populations of 157 000 and 52 000 respectively, of whom 27% and 15% respectively have access to drinking water. In this context, access to drinking water is defined as the possibility for a family to take its water from a properly constructed water point, delivering drinkable-quality water, situated less than 1 hour's walk away and serving a maximum of 300 users (i.e. an average of 20 litres of water available per person per day for a well or borehole equipped with a handpump).

Access to water is of crucial importance to these rural populations, and the only resource used all year round is groundwater.

**Figure 5.56: Geological sketch of the districts of Caia and Chemba (Mozambique).**



**Table 5.XI: Electrical conductivity of water and hydrological data (Thornwaite’s formula, steps of one month, period: 1946 to 1955).**

Zone	Average electrical conductivity of the groundwater ( $\mu\text{S}/\text{cm}$ )	Average yearly rainfall (mm)	Average yearly temperature ( $^{\circ}\text{C}$ )	Total yearly run-off (mm)
North (Chemba)	3700	728	34	56
South (Caia)	1500	954	32.3	200

*Hydrogeological questions facing the prospector*

The aquifers required for the establishment of new water facilities are those permeable layers of alluvia and fissured and weathered zone of sandstone where water mineralisation levels are low enough to provide water fit for human consumption.

In searching for water, the questions facing the prospector were the following:

- which zones in a radius of about 1 km around the villages contain aquifers?
- in these zones, what is the reservoir geometry (where to drill the boreholes)?
- what are its hydraulic characteristics (what will the borehole’s output be)?
- what is the electrical conductivity of the water (is it drinkable)?

The standard methods can not satisfactorily answer these questions – the average borehole success rate is low (<50%), even reaching zero for certain zones (sandstone plateaux). Geophysical methods may sometimes prove better able to clarify the situation. The first step is to select which geophysical methods to use. The next is to take the results of experiments in the field to assess the technical and economic utility of the methods, used on their own or in combination with others. Finally a tested hydro-geophysical procedure can be chosen.

**5.4.2 THE CHOICE OF GEOPHYSICAL METHOD(S)**

This choice is guided *a priori* by the nature of the reservoirs being sought, the required precision and the size of the zones to be prospected (see Section 4).

In the region considered, highly variable water mineralisation levels exist, and so resistivity is the physical parameter most likely to furnish the relevant information, because it is highly sensitive to the electrical conductivity of the water.

The high probability of encountering clayey layers inside the alluvia, and the *a priori* knowledge of the existence of highly mineralised groundwater indicate that the formations studied are good electrical conductors. In these conditions, electromagnetic resistivity measurements are preferable to direct current methods.

The precision must be sufficient to enable a borehole to be sunk with certainty on the extension of the anomaly. TDEM soundings in the light-equipment configuration can measure to depths of around 100 m in this conducting environment. On the other hand, they integrate signal over a large volume (depending on the size of loop used), and in the presence of complex structures, they cannot give a sufficiently precise picture of the lateral variations.

The only method that can routinely be used to perform the two-dimensional resistivity measurements necessary to describe complex geological structures is electrical resistivity imaging (ERI).

MRS can provide information on the presence of groundwater and on the characteristics of the reservoirs.

A TDEM sounding takes only 30 to 45 minutes to perform (including setting up the equipment and taking the readings), compared with 2 or 3 hours for a conventional ERI and 2 to 20 hours for an MRS.

For the specific context of Mozambique, the methods ultimately chosen were:

- TDEM soundings to map the resistivity as a function of depth and indicate the likely aquifer zones (Figure 5.57);



**Figure 5.57: Setting up a TDEM measurement (Mozambique, 2000).**



**Figure 5.58: Traditional well in Nhamago (Mozambique, 2000).**

- ERI to map the resistivity in two dimensions and thus determine the geometry of the potential reservoirs and the electrical conductivity of the water contained;
- MRS to confirm the existence of the reservoirs and determine their hydraulic characteristics.

#### 5.4.3 APPLICATIONS OF THE GEOPHYSICAL METHODS

##### *Searching for potential sites: TDEM soundings*

After some field reconnaissance, the geophysical prospecting zones were chosen as near as possible to the villages that were considered as top priority in terms of the population's water requirements. Aerial photos were of limited use, since it was often impossible to identify any location on the images! (The area had been a war zone for a long time and none of the infrastructure visible on the photos, including the roads, was identifiable on the ground any longer.) So it was mainly the geomorphology and discussions with the villagers that informed the choice of potential aquifer zones.

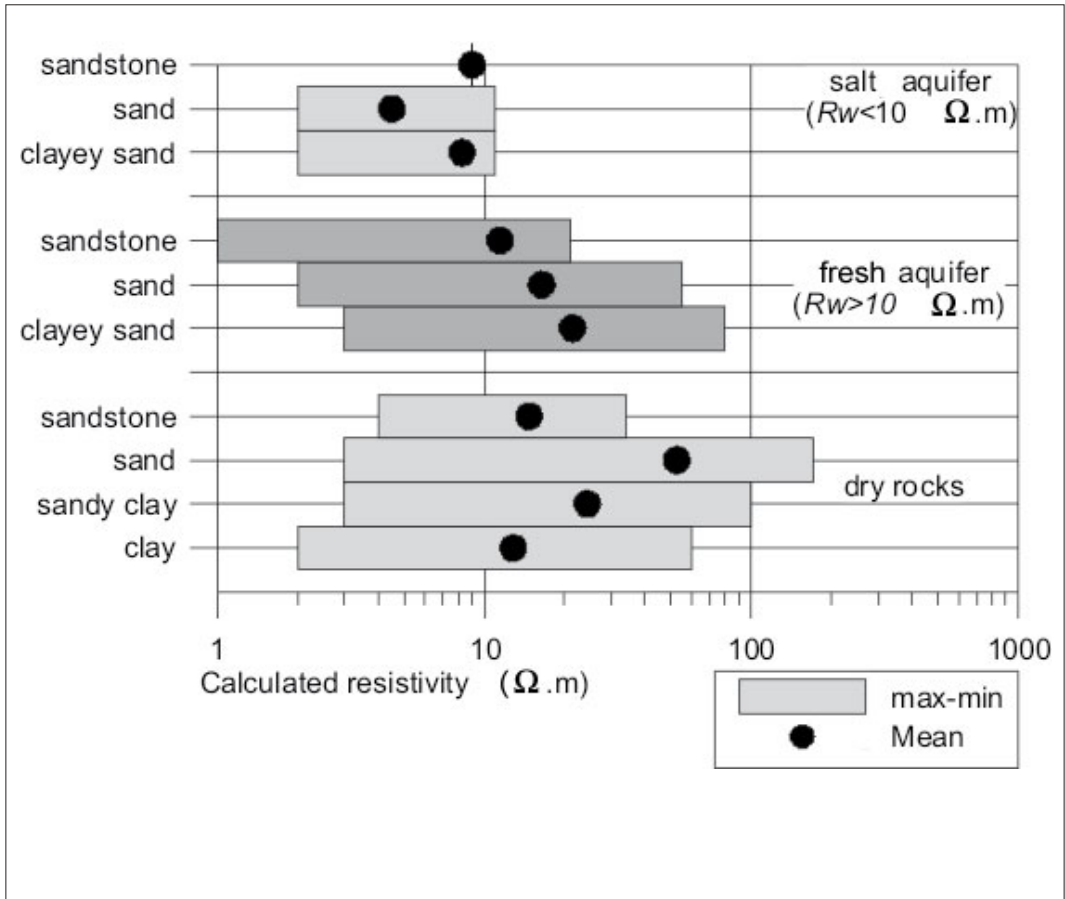
When the zones to be prospected are extensive, it is advisable to perform some quick measurements in order to class the various sites according to their aquifer-bearing potential.

In the region concerned, TDEM soundings were well adapted to this purpose. They are easy to set up and their results are sufficient to indicate the zones on which more detailed (but more difficult) research should be concentrated.

Figure 5.59 shows the example of the village of Nhamago situated in a uniform sandstone environment. A calibration sounding was first performed around the traditional well used by the local people (shown in Figure 5.58 and marked as 'Nm well' in Figure 5.59), and the calculated resistivity values were compared to direct measurements and observations in the well:

- The resistivity of the sandy aquifers was ill-defined because the TDEM method is insensitive to the first few metres in depth. These sands are nevertheless noted as being much more resistive than the material lying underneath them.
- The electrical conductivity of the water (at 25°C) was 770  $\mu\text{S}/\text{cm}$ , or 13  $\Omega\cdot\text{m}$ .
- A clayey layer identified at the bottom of the well showed a calculated resistivity of less than 10  $\Omega\cdot\text{m}$ .
- The sandstone substratum crops out near the well. It is also highly conducting and presents a calculated resistivity of less than 15  $\Omega\cdot\text{m}$ .

The geophysical target zone was thus identified as a resistive mass resting upon a conducting substratum.



**Figure 5.59: TDEM soundings, village of Nhamago (Mozambique, 2000).**  
 **$R_w$  is the resistivity of the water.**

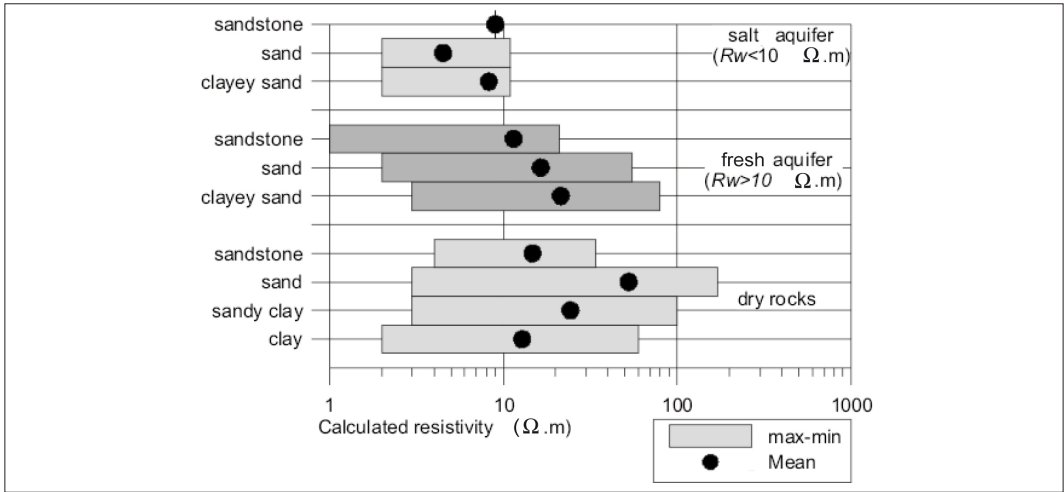
Eleven TDEM soundings were performed over two days on suspected anomalies (determined by the geomorphology). The results of the interpretations are presented in Figure 5.59. Two groups of curves can be distinguished: the first group, for which the calculated resistivities are under  $10 \Omega.m$ , is interpreted as clayey sandstone; the second represents the more resistive surface formation lying above the conducting substratum. The most favourable sites are those whose resistive layers are the most clearly evidenced, in terms both of their thickness and their calculated resistivity value (e.g. Nm3 and Nm4).

#### *Revealing complex structures: ERI*

Even if the calculated resistivity values are difficult to correlate with rock types, it may still be possible to use the resistivity contrasts to show up geological structures.

Figure 5.60 presents the calculated resistivity values obtained from 43 soundings performed in Mozambique. The dispersion of the values around the mean and the overlap of the different ranges (dry rocks, freshwater aquifers and saltwater aquifers) mean that a resistivity value cannot solely be associated with a particular type of rock. The presence of clay and contrasted mineralised water explains this phenomenon.

In these circumstances, two-dimensional measurements can furnish additional information through the qualitative interpretation of the variations in resistivity.

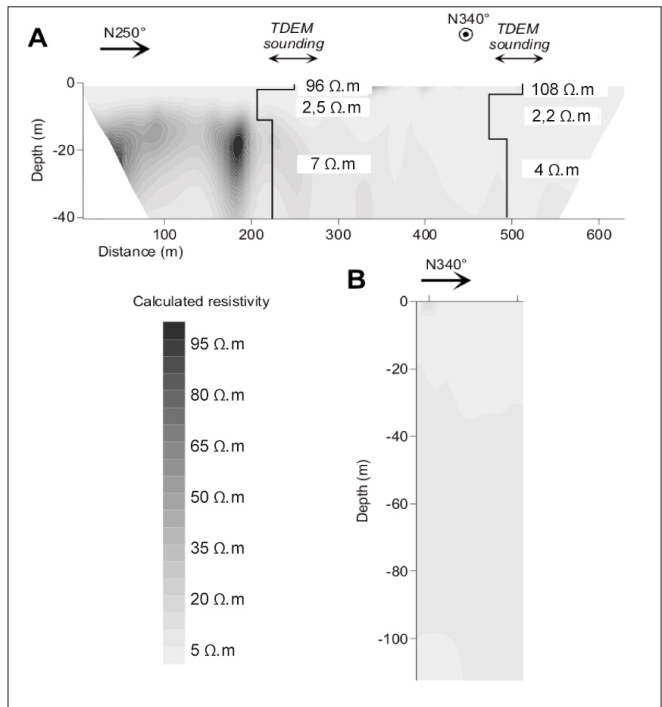


**Figure 5.60: Calculated resistivity as a function of rock type, population of 43 measurements.  $R_w$  is the resistivity of the water (Mozambique, 2000).**

Figure 5.61 shows the resistivity measurements performed in the village of Chivulivuli, situated in the north of the zone, at the limit between a sandstone zone and the alluvial capping layer from the Zambezi river 3.5 km away. The set of TDEM soundings carried out for the preliminary study did not exhibit any highly-marked contrast — the results of two typical soundings are presented in graph A. However, an ERI was performed to see whether this weak contrast might nevertheless prove significant.

Resistivity variations (contrasts) are clearly revealed by the two-dimensional measurement; they suggest the following structures (Figure 5.61, graph A):

- The shallow, highly conducting (1 to 5  $\Omega.m$ ) layer present across the whole section clearly indicates a clayey stratum.
- In the western part of the ERI, the low resistivities continue at depth and may be indicative of a clay-silt medium.
- Finally, the deeper resistive zone to the east of the ERI (30 to 80  $\Omega.m$ ) is certainly more sandy.



**Figure 5.61: TDEM soundings and ERI, Chivulivuli site (Mozambique, 2000). A: section of the calculated Wenner alpha resistivities (RMS = 2.9%). B: perpendicular cross-section of the calculated pole-pole resistivities (RMS = 2.3%, inversion performed with the RES2DINV programme).**



**Table 5.XII: Boreholes and MRS, Chivulivuli site (Mozambique, 2000).**

Borehole	Total depth (m)	Screen position (m)	Static level (m)	Air-lift discharge (l/h)	MRS water concentration (%)	Time constant $T_2^*$ (ms)	Water electrical conductivity ( $\mu\text{S/cm}$ )	Aquifer resistivity ( $\Omega\cdot\text{m}$ )
8/FCH/98	28.5	22-27	2.2	1000	17	230	650	40
2/GCH/00	36	4-9	2.2	1200	8	200	33000	2
9/FCH/98	10.5	4-9	4.5	1000	3	180	11000	2
1/GCH/00	37	3-8	4.5	1200	3	180	10000	2

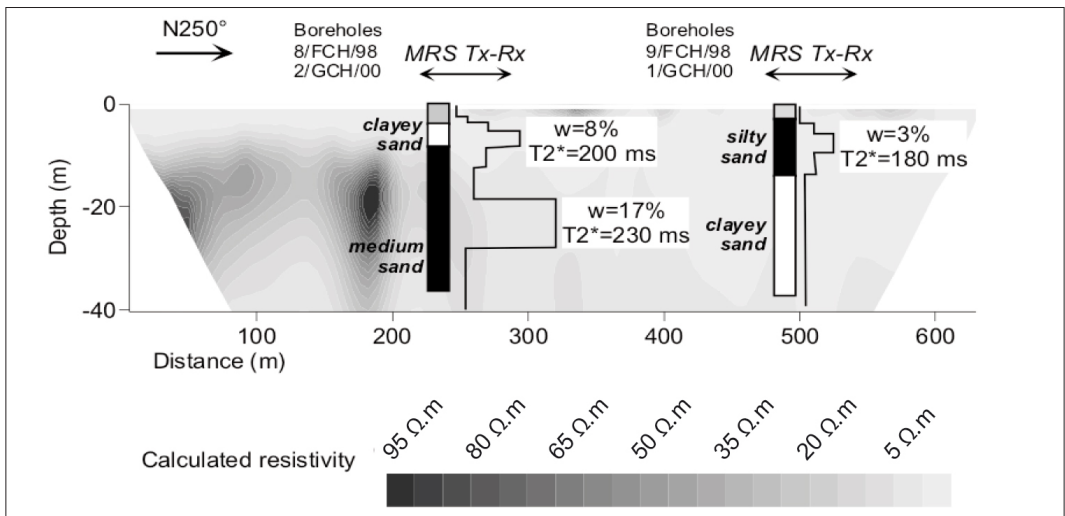
A second measurement, perpendicular to the first and centred on a point 470 m from the first ERI measurement was performed using a pole-pole apparatus, giving a greater penetration depth (all other parameters remaining constant – graph B). The resulting image is much more uniform, confirming that the structures are two-dimensional (east-west) and that the domain of validity of the method is respected.

In conditions such as these, ERI thus yields additional information about the existing structures, and enables the hydrogeologist to envisage the geometry of the potential reservoirs. But the existence of underground water remains uncertain because resistivity values alone do not unambiguously indicate the presence of water.

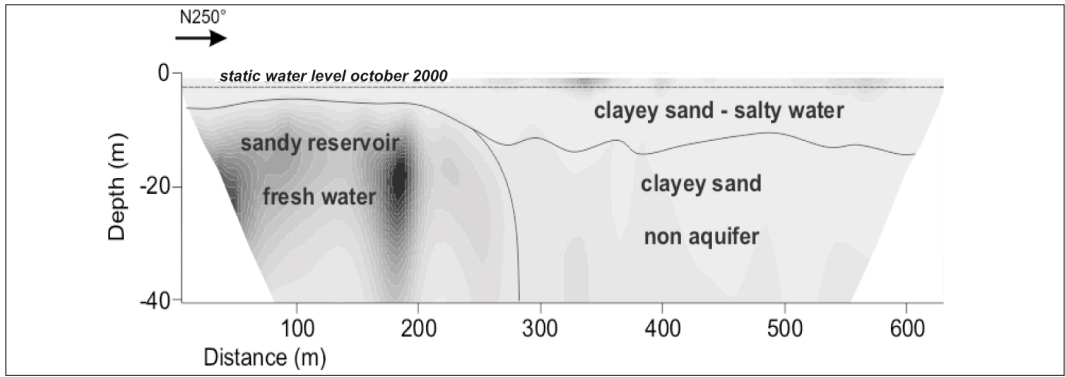
*Confirmation of the presence of underground water: MRS*

On this same site at Chivulivuli, MRS tests were carried out on the two formations revealed by the calculated cross-sectional resistivity. The interpretation of these tests was checked by drilling two pairs of boreholes. The results are presented in Table 5.XII and Figure 5.62.

MRS reveals the presence of a reservoir over the whole profile, between 2 and 10 m in depth. The very low resistivity of this horizon ( $2 \Omega\cdot\text{m}$ ) clearly indicates highly mineralised water (and not a clayey layer as one might initially imagine from the ERI results). The three boreholes which exploit this aquifer confirm these findings: the reservoir exists (air-lift yield of about  $1 \text{ m}^3/\text{h}$ ) and the water is highly mineralised (10 000 to 33 000  $\mu\text{S/cm}$ ).



**Figure 5.62: ERI and MRS, Chivulivuli Site (Mozambique, 2000).**  
**W is the water fraction and  $T_2^*$  the measured decay constant.**



**Figure 5.63: Representation of the Chivulivuli aquifer (Mozambique, 2000).**

A second reservoir is revealed by MRS to the east of the profile. The much higher water concentration, for a slightly longer signal decay time, indicates a more productive formation than the surface reservoir. The resistivity of this volume is much higher and one may expect it to contain moderately mineralised water.

Two boreholes were drilled to confirm these findings, but only one could be used because the other one, situated to the west, collapsed and so was not finished (1/GCH/00). The remaining borehole, which exploited the formation to the east of the profile, confirmed the geophysical information: the aquifer exists and delivers water that is only lightly mineralised for this region (650  $\mu\text{S}/\text{cm}$ ).

#### *Aquifer characterisation by ERI+MRS*

Using the complementary information given by MRS and the ERI, it is possible to propose a hydrogeological model for the site (Figure 5.63). This model is qualitative rather than quantitative, because the number of measurements is not sufficient to enable a calibration of the MRS hydrogeological estimators. Examples of calibrations are given in Chapter 5B.

#### 5.4.4 PROPOSING A HYDRO-GEOPHYSICAL PROCEDURE

Geophysical tools can be useful for two reasons:

- They provide information which enable positive boreholes to be drilled in failure zones, thereby meeting the water requirements of the population.
- They can save money for the programme, by reducing the number of salty, dry or low-output boreholes drilled.

#### *The overall success rate*

ACF built 178 water access points between 1994 and 2000. The negative boreholes have only been recorded systematically since 1997. Since this date, the annual averages are:

- 11.3 negative boreholes and 9 positives (55.6% failure rate);
- 7.3 dry boreholes (35.8% of the negative boreholes);
- 2.5 salty boreholes (12.3% of the negatives);
- 1.5 boreholes abandoned because of drilling problems (7.4% of the negatives).

In 1999, the introduction of one-dimensional geophysical techniques (Schlumberger VES) increased the borehole success-rate from 29 to 54% in similar geographical zones. This improvement is essentially due to a reduction of 16% in the number of salty boreholes, whereas the number of dry boreholes scarcely diminished. There are thus limits to the usefulness of resistivity measurements in this context: the resistivity values enable identification of reservoirs containing highly mineralised water (low resistivity), but do not signal the simple presence of water.



A geophysical programme using new methods was therefore organised from October to December 2000. The study-sites selected (4 sites with a total of 15 boreholes) corresponded to zones in which all the boreholes previously drilled had been negative. These were thus the most difficult sites encountered since the beginning of the project in 1994. The combined use of the TDEM, ERI and MRS methods yielded a success-rate of 66%.

*Economic analysis of geophysical studies*

Table 5.XIII presents the cost of geophysical studies per site in Euros. The calculation is performed using real ACF costs in 2000, on the following basis:

- 4x4 vehicle, used partly for geophysical studies, bought new, depreciation to 0 over 5 years;
- geophysics equipment bought new, depreciation to 0 over 5 years (except the VES equipment: over 3 years);
- team of technicians and full-time geophysics workers;
- 9 months work in the year, with 10 days per site, giving 27 sites per year.

**Table 5.XIII: Cost of geophysical studies in Euros (ACF, Mozambique, 2000).**

Method	National staff		International staff		Geophysical equipment				Vehicle		Number of studies per year	Admin. cost %	Cost per site (€)
	number	cost/study	number	cost-study	purchase cost	amortisation (year)	misc. cost/study	cost/study	number	cost/study			
VES	4	327	1	311	4 200	3	10	56	1	218	27	48	649
ERI	5	373	1	311	30 000	5	10	227	1	218	27	65	883
ERI + MRS	8	691	1	311	141 000	5	20	1 053	1	218	27	157	2 119
ERI + MRS + TDEM	10	840	1	700	183 510	5	30	1 373	1	327	27	203	2 743

The cost of a negative borehole calculated on the same basis is 3 655 Euros, and the cost of a positive borehole is 4 483 Euros. Using these costs, one can determine the domain of economic utility of the various methods or combinations of methods as a function of the improvement in the borehole success-rate they produce (Figure 5.64).

On the scale of ACF programmes, and for the geophysical campaign in 2000, it can be noted that:

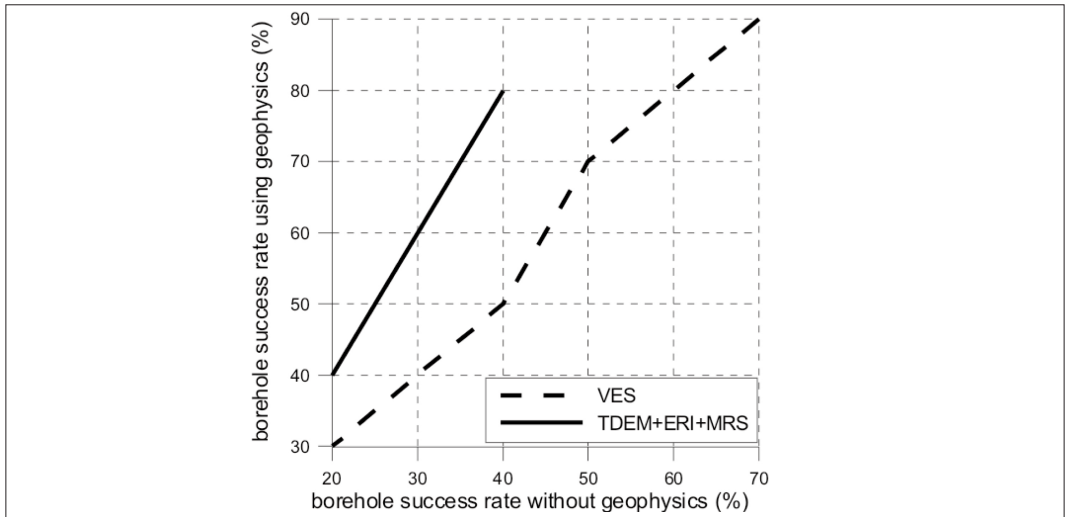
- the use of the VES method, which increased the borehole success-rate by 24% on its introduction 1999, is economically viable whatever the borehole failure-rate;
- the combined use of the 3 methods (TDEM, ERI and MRS) is justified financially on difficult sites (success-rate below 40%) if the success-rate is doubled, which seems realistic.

*Recommendation*

The decision concerning the type of geophysical procedure to use as part of a hydrogeological study (Table 5.XIV) is based on technical evaluations and economic analysis.

Technically, the merits of the combined use of several geophysical methods in this region are illustrated by the examples cited above:

- TDEM soundings enable rapid prospecting over vast zones judged promising in the land survey (photo-interpretation, geomorphology and geology). They indicate the sites on which to perform ERI.
- Two-dimensional resistivity measurements are used to trace underground structures and reveal the potentially aquifer-bearing zones on which MRS can be performed.
- MRS confirms the presence of groundwater and furnishes information on the hydraulic parameters of the reservoir.
- Finally, the interpretation of the MRS parameters combined with the electrical resistivity of the aquifers provides an estimate of the electrical conductivity of the water.



**Figure 5.64: Economically favourable domain of geophysical methods (ACF, Mozambique, 2000).**

**Table 5.XIV: Hydro-geophysical procedure (Mozambique, 2000).**

Phase of study	Methods and tools	Objective
Preliminary study	Photo-interpretation (when zone location is possible)	Identification of the geological domains (sandstone/alluvia) Identification of lineaments in the sandstone zones
Field reconnaissance	Geological & geomorphological observations Visit existing water access structures	Confirmation of the local geology and of the hydrogeological targets
Geophysical study	TDEM Soundings ERI MRS	Identification of potential aquifers Definition of the potential reservoir's geometry and the water mineralisation level Confirmation of aquifer's existence and hydraulic characterisation
Complementary study	Reconnaissance borehole Water analysis MRS Pumping test Piezometric measures	Elucidation of the groundwater dynamics Reservoir and groundwater characterisation Evaluation of the borehole's impact on the water resources

## B FIELD EXAMPLES

<b>1</b>	<b>Implementing boreholes in unconsolidated sediments</b>		<i>2.1.1 Crystalline bedrock aquifers</i>	199	
		188	<i>2.1.2 Equipment and methods</i>	199	
1.1	Background	188	2.2	Main results	200
1.1.1	<i>Physical environment</i>	189	2.2.1	<i>Reservoir typology</i>	200
1.1.2	<i>Human environment and drinking-water coverage</i>	190	2.2.2	<i>Reservoir geometry</i>	201
1.1.3	<i>Hydrogeological environment</i>	190	2.2.3	<i>Reservoir hydraulic parameters</i>	202
1.1.4	<i>Test-survey methodology</i>	190	2.2.4	<i>Improvement of the aquifer characterisation</i>	203
1.2	Results example	191	2.2.5	<i>Main limiting factors</i>	203
1.2.1	<i>A high-yield borehole: ACPI school</i>	191	2.3	Conclusion	203
1.2.2	<i>A heterogeneous site example: Mukpen village</i>	194	<b>3</b>	<b>Localisation of saturated karst aquifers</b>	204
1.3	Discussion	196	3.1	Background	204
1.3.1	<i>Technical analysis</i>	196	3.1.1	<i>Physical environment</i>	204
1.3.2	<i>Cost analysis</i>	197	3.1.2	<i>Survey objective and methodology</i>	205
1.3.3	<i>Conclusion: geophysical implementation methodology</i>	198	3.2	Field example	207
<b>2</b>	<b>Characterisation of crystalline bedrock aquifers</b>	199	3.2.1	<i>MRS saturated-karst localisation</i>	207
		199	3.2.2	<i>ERI karst structure estimation</i>	208
2.1	Background	199	3.3	Conclusion	208

To illustrate the way hydro-geophysical procedures are carried out by ACF when investigating groundwater, three examples are presented that correspond to some of the main geological contexts: recent unconsolidated sediments in Cambodia, crystalline bedrock in Burkina Faso and karstic limestone in France as an example of a highly heterogeneous context.

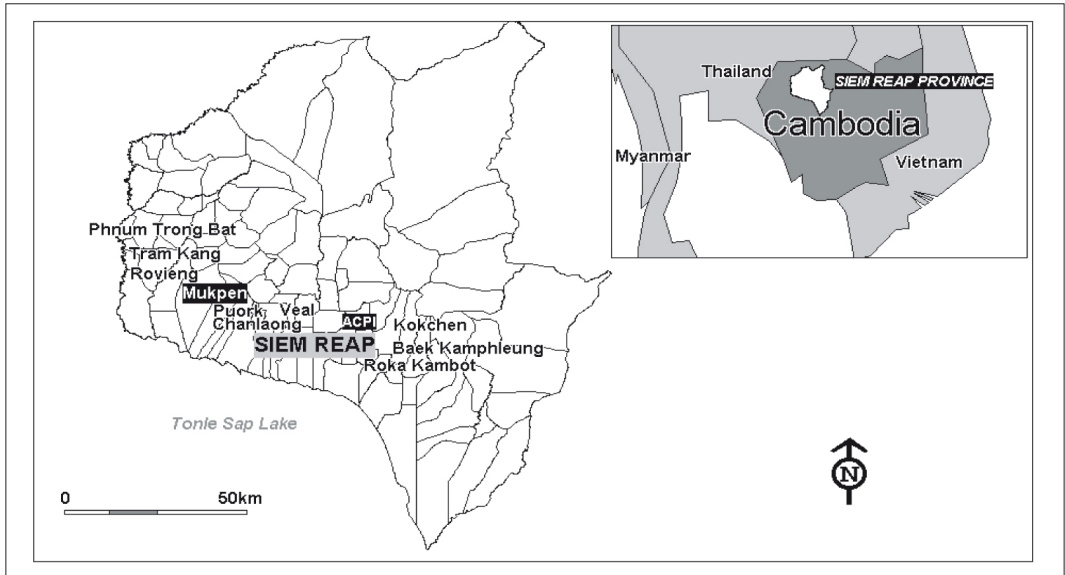
To improve readability, the scientific references used in Chapter 5B are not noted, but they can be found in the main reference list.

### 1 Implementing boreholes in unconsolidated sediments

Unconsolidated sediments are a common geological context for ACF programmes. They are of great potential for supplying water for many people because they are widely represented all over the world, and their development is usually easy and accessible to users. However, these groundwater resources can also be difficult to develop because of their clay content, and because they are commonly vulnerable to surface pollution and sometimes subject to excessive mineralisation. To improve its procedures for studying these resources, ACF conducted a test project in Cambodia with the support of a French research institute, IRD (*Institut de Recherche pour le Développement*), and a geophysical equipment company, Iris Instruments.

#### 1.1 Background

ACF started its programme in Siem Reap province of Cambodia in 1992 (Figure 5.65). Its objective was to support the people who had fled into Thailand to return and resettle in their previous home area. By the end of 1998, 900 boreholes had been drilled in rural areas to supply the population



**Figure 5.65: Siem Reap Province and main investigated site.**

with drinking water. Of these 900 boreholes, 180 were unsuccessful, most of these in particular areas, where the failure rate reached more than 70%.

The province is highly affected by human activities (paddy fields, irrigation infrastructure etc.) and the traditional hydrogeological tools of photo interpretation or field cartography are not useful to site boreholes. Furthermore, the cuttings analysis of the drilled boreholes shows high lithological heterogeneity at the provincial scale (kilometres range) or at the village scale (hundreds-of-metres range). Geophysics is a good technique in this kind of context and several different tools were selected to survey the province for the following reasons:

- 1) The rock resistivity provides geological and groundwater-quality information in many instances. An electromagnetic method, such as TDEM sounding (time-domain electromagnetic) is more efficient in conductive environments than common VES (vertical electrical sounding) because of its high sensitivity to conductive layers.
- 2) The use of one-dimensional measurement is unsuitable in complex geological areas where two-dimensional measurement such as ERI (electrical resistivity imagery) is more effective.
- 3) The resistivity of an aquifer is related to the EC (electrical conductivity) of its water. When the groundwater EC is high, the resistivity of the aquifer can reach the same range as a clayey medium and the resistivity parameter is of no use in determining the aquifer. Here, the MRS (magnetic resonance sounding) method is most appropriate, because of its effectiveness in determining groundwater occurrence, whatever its conductivity.
- 4) To answer the fundamental questions of hydrogeologists implementing boreholes (Where is the groundwater? What could be the expected yield of a drilled borehole? What is the water quality?), the joint use of resistivity measurements and MRS methods could be helpful.

As a consequence, a 6-week test survey was organised at the end of 1998 at 12 sites, using VES, TDEM, ERI, and MRS jointly.

### 1.1.1 PHYSICAL ENVIRONMENT

Siem Reap province is located North of Tonle Sap Lake, in the North-Western part of Cambodia (Figure 5.65). The total surface area of the province is 15 270 km<sup>2</sup>. Except for the Kulen

mountains in the north (maximum 487 m ASL) and several isolated peaks (known as Phnom), the province is flat. The main rivers flow from the North to the Tonle Sap Lake in the South. The province has a tropical monsoon climate, with two rainy seasons (May-June and August-October), an average annual rainfall of 1 500 mm and an average air temperature of 26.7°C.

### 1.1.2 HUMAN ENVIRONMENT AND DRINKING-WATER COVERAGE

The population of the province is about 650 000 (1993). The different economic activities are farming and fishing (90%), trading (7%) and services (3%). The main agricultural activity is paddy rice farming.

The potable drinking-water coverage of the province is estimated to be about 25%, provided by shallow wells (3 to 6 m deep) and boreholes (20 to 80 m deep), mostly equipped with handpumps. The 75% of people who don't have access to potable drinking-water draw water from ponds, rivers and open wells. The health statistics shows that 40% of the hospital admissions and 64% of the known deaths in the province are due to water and environmental diseases.

### 1.1.3 HYDROGEOLOGICAL ENVIRONMENT

The province is mainly located in a sedimentary basin that consists of 20 to 100 m thick layers of late Tertiary to Quaternary sediments that range from coarse sand to clay. These rocks lie on older consolidated sediments (Secondary to Tertiary sandstone to mudstone) and igneous rocks (diorite, granodiorite, basalt and andesite) which outcrop in the Kulem and Phnom mountains.

The aquifers can be subdivided into:

1) Shallow unconfined aquifers (alluvium deposits) which range from 2 to 5 m deep on average. These aquifers are used by the population through shallow wells, which are sometimes temporary and almost always polluted by organic matter.

2) The aquifers targeted by the drilling programme, ranging from 20 to 80 m deep. They are often confined and heterogeneous:

- in the East of the province, the aquifers are often clayey (clayey sand). The average transmissivity is  $10^{-6}$  m<sup>2</sup>/s and the average drilling success rate is 35%;
- in the central part of Siem Reap, the sediments are more sandy (less clay) and the average transmissivity is  $10^{-2}$  m<sup>2</sup>/s. The drilling success rate reaches almost 90%;
- in the Western region, the aquifers are mainly sandy silt and the average transmissivity reaches  $10^{-5}$  m<sup>2</sup>/s. The average drilling success rate is 60%.

### 1.1.4 TEST-SURVEY METHODOLOGY

Twelve sites were chosen according to human and technical parameters: the water needs of the people, sites where the aquifer was well identified and sites where several boreholes were unsuccessful. The field surveys were conducted using the four geophysical methods: VES, ERI, TDEM sounding and MRS. The interpretation of the field data was conducted firstly independently for each method, and then jointly, using the available tools (Table 5.XV). Based on these results, boreholes were drilled and tested by electrical logging and pumping tests.

The pumping tests implemented were step tests. The objective was to estimate the specific capacity, the linear and the quadratic head loss, and the maximum exploitation yield of the boreholes. Recovery analyses were also done to estimate the aquifer local transmissivity. The pumping tests were interpreted using the Jacob formula. The technical contribution of geophysics to the borehole success rate was estimated from these twelve sites, and the financial contribution of geophysics to the borehole programme was calculated with ACF figures.

Finally, combining the technical and the cost analyses, a geophysical methodology for borehole siting, drilling and testing was proposed.

**Table 5.XV: Methods, equipment and interpretation tools.**

Method	Array	Equipment	Interpretation tools
VES	Schlumberger and pole-pole	$\Omega$ mega (Aquifer)	Cagniard curve and 'QWSEL' software
ERI	Pole-pole	SYSCAL R2(IRIS Instruments)	'RES2DINV' software
TDEM	Tx: 100 x 100 m & 75 x 75 m Central Rx: 31.4 m <sup>2</sup>	PROTEM 47 (Geonics Ltd.)	'TEMIX' software
MRS	TX/Rx: 75x 75 m & 37.5 x 37.5 m	NUMIS (IRIS Instrument)	'Samovar' software
DC logging	Normal probe 8" & 32" Fluid resistivity	ACF	
Drilling / borehole	Mud rotary 6" PVC casing 4" Screen 0.8 mm slot & 7.5% opening area Gravel pack 1-5 mm	PAT-ACF 201	
Pumping test	1 to 4 pumping steps	4" submersible pump	'Jacob' equation

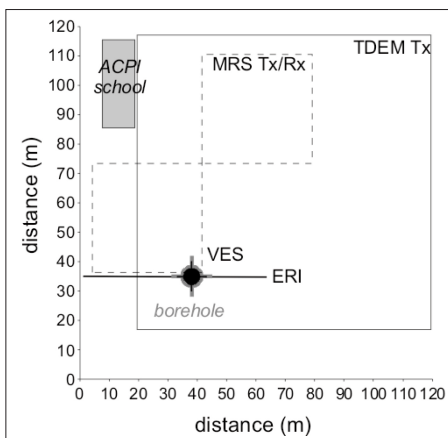
## 1.2 Results example

### 1.2.1 A HIGH-YIELD BOREHOLE: ACPI SCHOOL

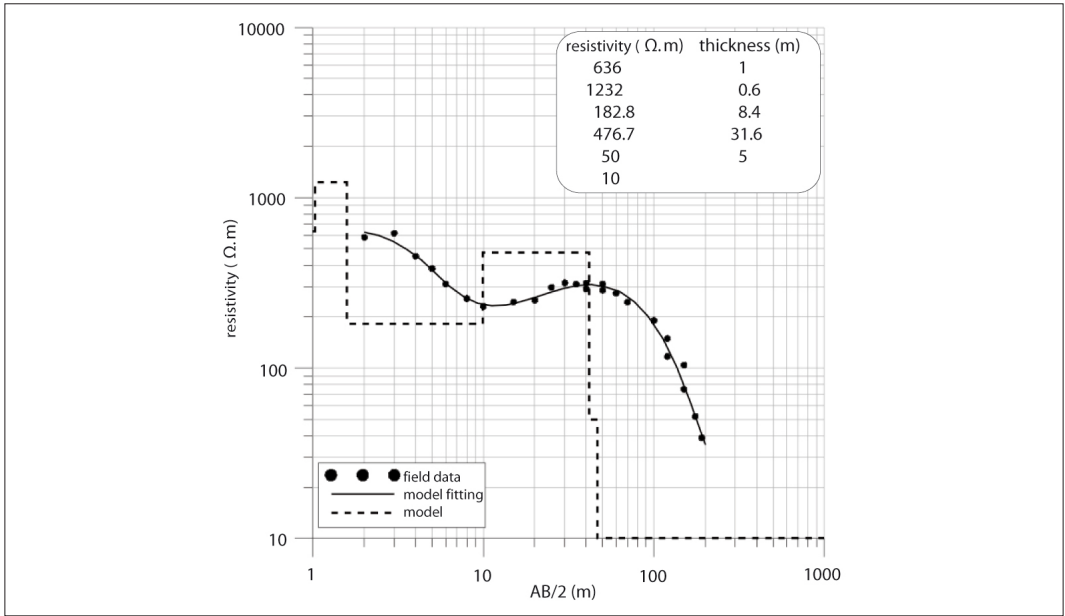
The objective was to construct a borehole to supply water to a school (Figure 5.66).

*One-dimensional resistivity measurement: VES and TDEM*

The inversion of the Schlumberger VES is presented in Figure 5.67. The geological interpretation of the VES is that the resistive layer of 477  $\Omega$ .m could be a sandy aquifer from 10 to 42 m deep, which overlies a clayey substratum dropping down to 10  $\Omega$ .m. The equivalence problems do not allow separate determination of the resistivity and the thickness of this potential aquifer (only its transverse resistance can be determined), and the thickness can range from about 26 to 36 m, which has a great influence on its transmissivity.



**Figure 5.66: Location map of geophysical survey at ACPI school.**



**Figure 5.67: VES Schlumberger (rms = 7.5%), ACPI School.**

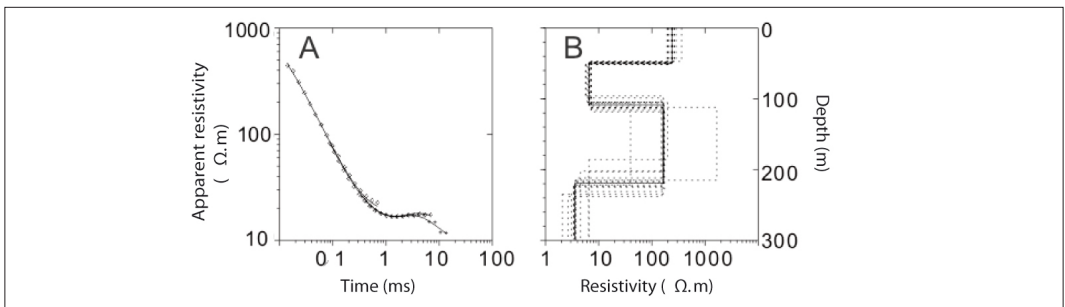
The inversion of the TDEM sounding (Figure 5.68) is similar to that of the VES but: (1) the TDEM enables a better definition of the interface between the top resistive layers and the conductive one to be obtained – the estimation of the bottom of the potential aquifer is then improved; (2) the first 10 m below ground level are defined with less accuracy due to the integration of the shallow information with the TDEM method; (3) the penetration over 200 m is deeper (with the arrays used).

*Two-dimensional electrical imaging: ERI*

The inversion result is in good agreement with the Schlumberger sounding, but it is smoother (Figure 5.69). It also gives additional information that is important for drilling the borehole: the potential aquifer (resistive layer) seems to be quite homogenous.

*MRS*

The raw data (Figure 5.70) shows reliable measurements: the signal-to-noise ratio is high (average of 10.6), the Rx frequency of the magnetic resonance signal is very close to Tx frequency (less than 0.5 Hz of difference) and the signal phase changes smoothly as the pulse moment increases.



**Figure 5.68: TDEM sounding, ACPI school.**  
**A: field data. B: inversion (equivalent models, best fit rms error = %).**

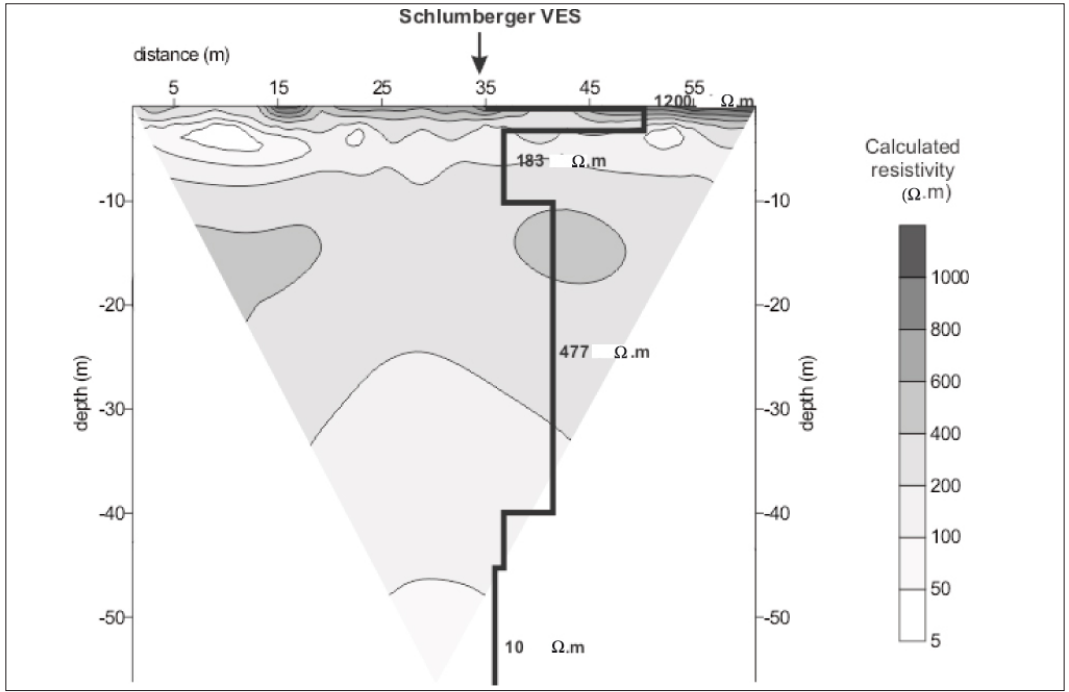


Figure 5.69: ERI (rms error = 3.1%) and VES inversion results, ACPI school.

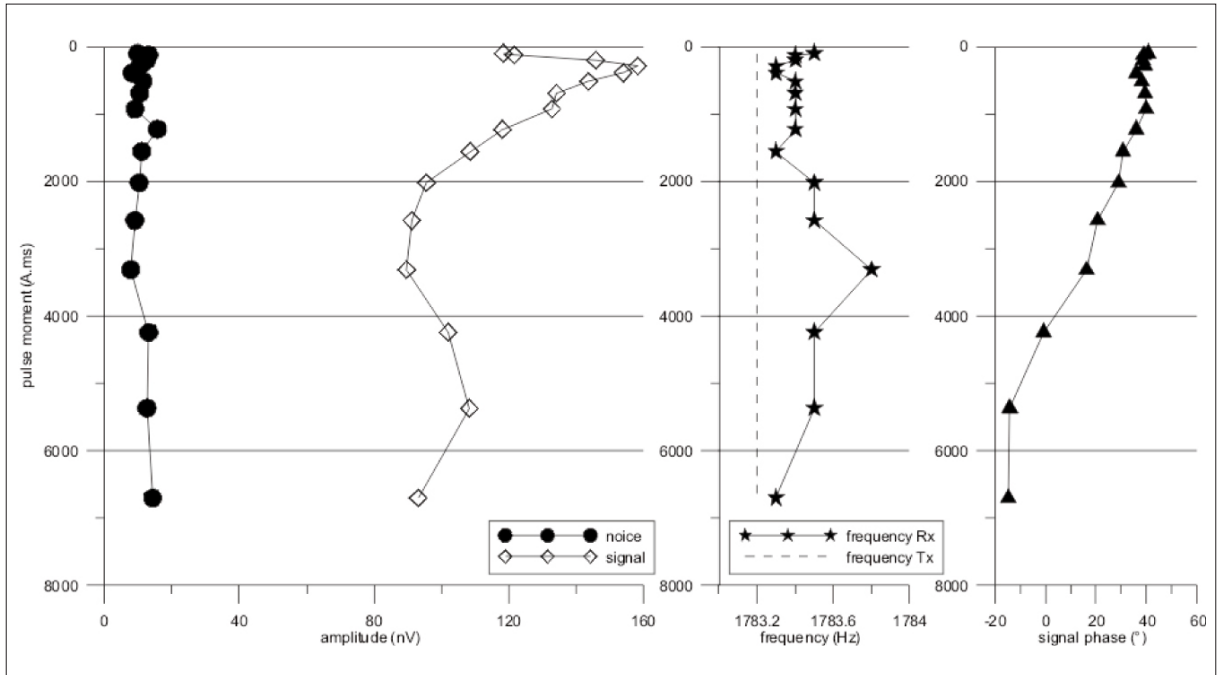
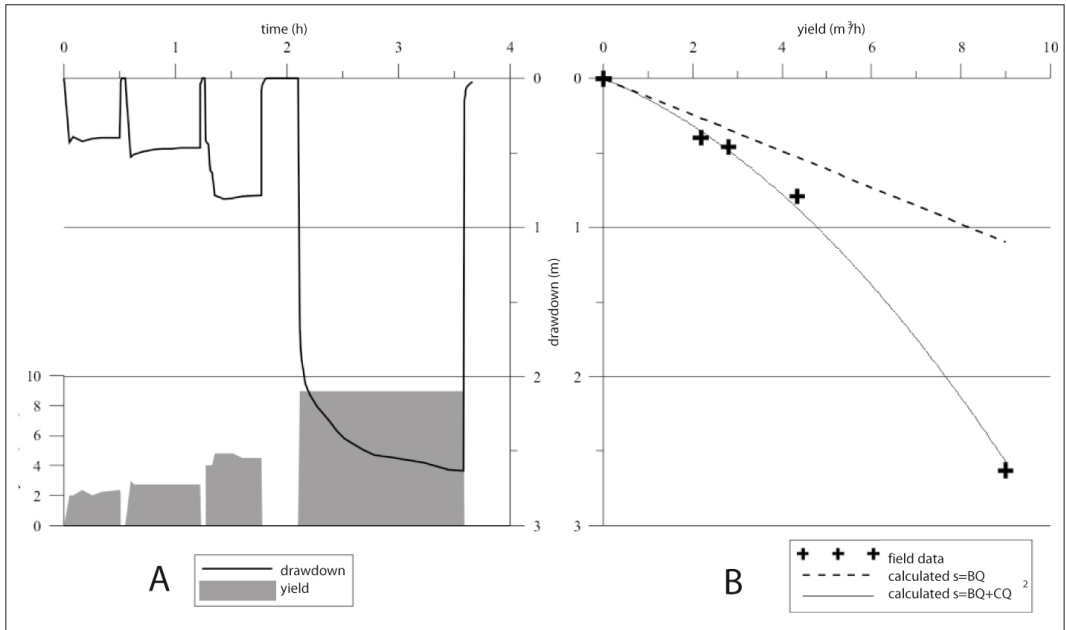


Figure 5.70: MRS raw data, ACPI school.





**Figure 5.71: Pumping test, ACPI school.**  
**A: field measurements. B: head-loss calculation.**

The MRS inversion (Figure 5.72) shows a water-bearing formation from 1 m to the bottom on the investigated depth. The water content ranges from 5 to 20% and the decay time from 160 to 280 ms.

#### *Borehole drilling and pumping test*

The drilled borehole was surveyed with by electrical logging that was mainly used to choose the best screen location. After the development of the borehole by air-lift, a 4-step pumping test was conducted (Figure 5.71). The critical yield was not reached during the test, but the quadratic headloss increased strongly when the pumping yield was increased to 9 m³/h. The maximum exploitation yield was fixed at 6 m³/h (beyond this point the quadratic headloss become higher than the linear one).

The local transmissivity was estimated from the recovery analysis to be  $1.8 \cdot 10^{-2} \text{ m}^2/\text{s}$  and the relative specific capacity was  $1.4 \cdot 10^{-3} \text{ m}^2/\text{s}$ . The groundwater resistivity at the end of the pumping test was  $350 \text{ } \Omega \cdot \text{m}$  ( $29 \text{ } \mu\text{S}/\text{cm}$ ), which was close to that of the local rainwater.

#### *Comment*

For this particular site, it can be seen (Figure 5.72) that the Schlumberger VES gives enough information to site the borehole successfully, even if the existing doubt regarding the aquifer thickness could only be removed with TDEM information. The ERI does not allow more accurate borehole siting, because the reservoir seems to be quite homogeneous. The MRS inversion gives realistic water contents regarding the lithology, but the  $T_2^*$  decay times is more difficult to correlate with the rock type.

### 1.2.2 A HETEROGENEOUS SITE EXAMPLE: MUKPEN VILLAGE

Three unsuccessful boreholes (yield  $\approx 300 \text{ l/h}$ ) were drilled in Mukpen village. A geophysical survey was conducted to locate a new site. Figure 5.73 shows a summary of the surveys carried out both on a previous unsuccessful borehole (Northern site) and on the new site selected for drilling (Western site).

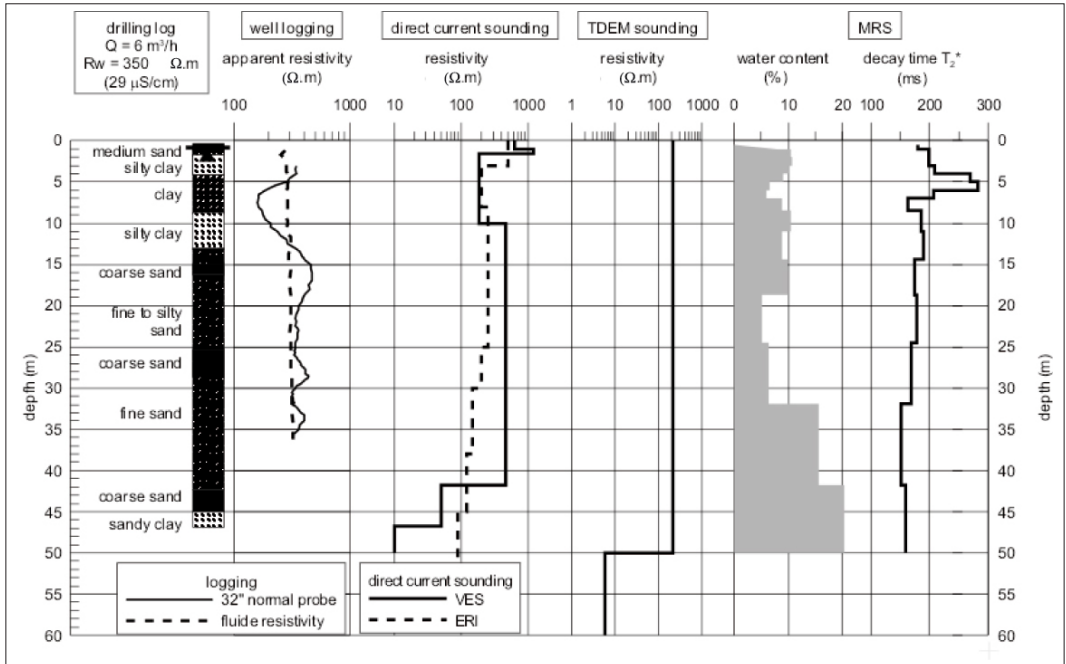


Figure 5.72: Geophysical results summary, ACPI site.

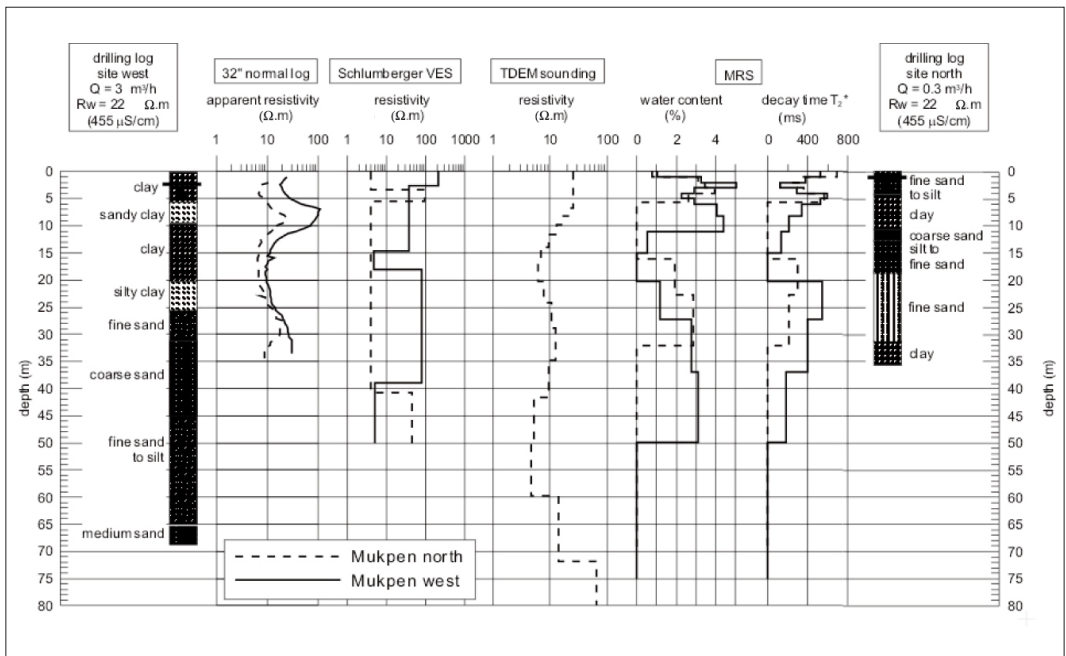


Figure 5.73: Geophysical results summary, Mukpen village.

### *Northern site: low-yield borehole*

The resistivity values indicate a conductive area (less than 10  $\Omega\cdot\text{m}$ ) which could not be interpreted as an environment with high hydrogeological potential. The MRS inversion gives a realistic estimate of water content corresponding to the lithology and the borehole yield, but the  $T_2^*$  decay time does not fit with the expected values (longer time for silty sand than for fine sand).

### *Western site: medium-yield borehole*

The Schlumberger sounding indicates a resistive layer of 80  $\Omega\cdot\text{m}$  between 18 and 39 m deep. This value corresponds to a sandy formation but is much lower than the one at the ACPI school site which was about 480  $\Omega\cdot\text{m}$ . This could be explained by a small clay content which had not been noticed or the low water resistivity of 22  $\Omega\cdot\text{m}$  (455  $\mu\text{S}/\text{cm}$ ) comparing to the 350  $\Omega\cdot\text{m}$  (29 $\mu\text{S}/\text{cm}$ ) at the ACPI school site. The thickness of the resistive layer is poorly defined by the Schlumberger sounding according to the borehole lithology.

The MRS indicates a water-bearing formation from 20 to 50 m deep, in good agreement with the lithology for the water content, but the  $T_2^*$  decay time does not fit with the expected values. As for the ACPI school site, some water with long decay time in a shallow clayey layer is measured.

### *Comment*

In this context of a sandy and clayey formation with conductive water, it can be noted that without *a priori* information on the groundwater electrical conductivity (EC), the resistivity methods do not enable reliable borehole siting because the aquifer resistivity is about the same as a sandy clay material. The MRS indicates higher potentiality, that is higher water content, longer relaxation time and a thicker saturated layer, for the western site. It enabled the successful siting of a borehole in Mukpen village.

## 1.3 Discussion

The application of geophysics to site a borehole could be useful for two reasons: (1) it helps ACF reach its objective of supplying people with drinking water, (2) it allows money to be saved within the programme by reducing the number of dry boreholes.

### 1.3.1 TECHNICAL ANALYSIS

#### *MRS*

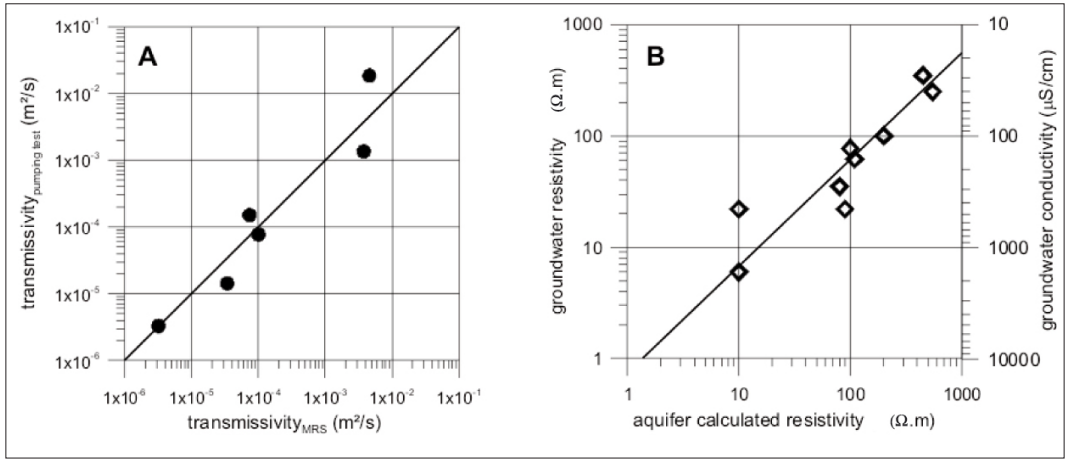
The MRS gave accurate information of water content according to the lithology. There was no clear link found between  $T_2^*$  decay time and the aquifer grain-size. According to the literature, the  $T_2^*$  decay time varies from 30 ms in clay to 400-600 ms in gravel formations. However, decay times of 100 to 200 ms were often found for clayey material, and less than 150 ms for coarse sand. This could be explained by variations in the magnetic properties of rocks which create local inhomogeneities in the geomagnetic field. The  $T_1$  decay time, which depends mainly on pore size, was not yet available at the time of the survey (1998).

However, MRS is the only method that enabled successful drilling of a borehole in a conductive environment. Figure 5.74 shows the links between the MRS data and local transmissivity of aquifers estimated from pumping tests. The MRS transmissivity was estimated as  $T = 1.6 \cdot 10^{-6} \cdot w^4 \cdot (T_2^*)^2 \cdot \Delta z$ , where  $w$  is the MRS water content in % and  $\Delta z$  the MRS saturated-aquifer thickness in m.

#### *Joint use of the methods*

On one hand, the main limitation of resistivity methods in Siem Reap is their high sensitivity to the water EC; on the other hand, this is their main advantage compared to MRS, which is not sensitive to the water quality (the water electrical conductivity is related to the ions which are present in solution).

As a consequence, resistivity methods and MRS can complement each other quite effectively: MRS can be used to locate groundwater, and resistivity methods can be used to check the mineralisation of the water (Figure 5.74).



**Figure 5.74: MRS hydraulic characterisation.**  
**A: local aquifer transmissivity B: groundwater electrical conductivity.**

TDEM is the most convenient method to integrate with MRS in this conductive environment as it can use the same transmitter coil, reducing the set-up time. In a heterogeneous area, an ERI could be used to look for the most convenient site where integrated TDEM/MRS could be carried out.

*Technical impact of geophysics*

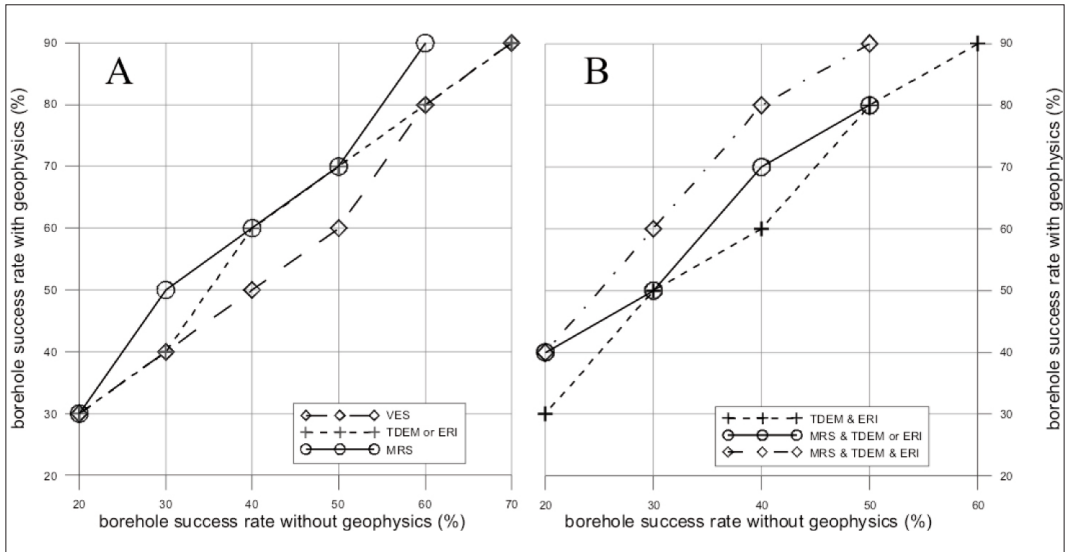
Within the 12 investigated sites, the use of geophysical methods increased the borehole success rate from 56 to 90% for a total of 36 boreholes that were used for this particular test survey. This improvement of success rate was due to: (1) better choice of the drilling sites, (2) better management of the drillers who received guidelines regarding the depth they had to drill, (3) better borehole installation, i.e. screen setting.

**1.3.2 COST ANALYSIS**

The cost analysis aims to measure the financial impact of geophysics on a drilling programme. Table XVI shows the average costs of geophysical surveys in Siem Reap province. The calculation includes the cost of staff (engineer, technician and labourers), logistics (vehicle purchase, running and depreciation costs) and the geophysical equipment (purchase, maintenance and depreciation). It was

**Table XVI: Cost of geophysical surveys, in Euro (€).**  
**cps = cost per survey. dd = duration of depreciation.**

	Staff No	cps	Geophysical equipment purchase cost	dd years	cps	Vehicle No	cps	Survey number per year	Admin. cost (8%)	Total cost per survey
VES	4	105	4 615	3	21	1	94	80	18	238
ERI	4	105	30 769	4	98	1	94	80	24	321
TDEM	3	74	53 846	4	151	1	83	90	25	333
MRS	3	74	92 307	4	258	1	83	90	33	448
MRS & ERI	5	136	123 076	4	413	1	100	75	52	701
MRS & TDEM	5	127	146 153	4	460	1	94	80	54	735
MRS & TDEM & ERI	7	188	176 922	4	557	2	187	80	75	1 007



**Figure 5.75: Cost-effectiveness boundaries of geophysical methods.**

**A: use of a single method. B: joint use of methods.**

done on the basis of 8 working months per year (dry period), 2 to 3 sites investigated per week, and cost calculated on real ACF expenses in 1998. Using the same calculation method, the average cost of a successful borehole is 2 380 €, compared with 1 260 € for an unsuccessful one.

Figure 5.75 shows the cost-effectiveness boundaries of using geophysical methods for siting and designing boreholes (it was prepared using the formula presented earlier in Chapter 5A, Section 4.1.2). Starting from the borehole success rate without geophysics, the figure shows the minimum success rate which needs to be reached, using geophysics, to save money. For example, for a situation where the borehole success rate without geophysics is 40%: (1) the integrated use of MRS, TDEM and ERI saves money when it increases the success rate to 80%; (2) the joint use of TDEM and MRS saves money when it increases the success rate to 70%.

### 1.3.3 CONCLUSION: GEOPHYSICAL IMPLEMENTATION METHODOLOGY

Integrating the technical and the cost analyses, it is possible to propose a geophysical methodology for borehole siting and design Siem Reap province. According to the different areas of the province and their known borehole success rate, the following methodology could increase the borehole success rate and save money at the programme scale.

*Very difficult area: borehole success rate without geophysics less than 30%*

The joint use of ERI, TDEM and MRS could reduce significantly the number of dry boreholes and could save money if the success rate is at least doubled. An average of one site could be surveyed per day.

First, ERI is used to choose the best site according to the vertical and lateral contrasts of resistivity and thickness.

Then MRS is carried out on the potential aquifer site to estimate the borehole productivity using Figure 5.74A. The TDEM sounding is used to accurately define the interface between the resistive aquifer and the conductive clayey substratum (to give recommendations to the driller). The electrical conductivity of the water can be estimated using the resistivity value of the layer identified as the aquifer by the MRS (Figure 5.74B).

*Difficult area: borehole success rate without geophysics between 30 and 50 %*

The joint use of MRS and resistivity methods (either ERI, to focus on local heterogeneity if necessary, or TDEM, which is easier to integrate with the MRS) is recommended. This joint use of methods could save money if the success rate is increased by at least 20 to 30%. An average of two sites could be surveyed per day.

*Common area: borehole success rate without geophysics more than 50 %*

VES could be used as a standard method saving money if the success rate is improved by 10 to 20%, which seems to be realistic up to a success rate without geophysics of 60 or 70%. An average of two sites could be investigated daily.

## 2 Characterisation of crystalline bedrock aquifers

Bedrock aquifers are of particular importance in tropical regions because of their wide spread and accessibility and because there is often no readily available alternative source of water supply. Even in humid tropical regions where surface water is readily available, water quality considerations can favour their use. To improve the current procedures to investigate groundwater resources in crystalline rocks contexts, a methodological survey was conducted in Burkina Faso by ACF with the support of IRD and Iris Instruments.

### 2.1 Background

#### 2.1.1 CRYSTALLINE BEDROCK AQUIFERS

Bedrock aquifers are developed within the weathered overburden and fractured bedrock of crystalline rocks which are mainly of Precambrian age. The usual conceptual model of the bedrock aquifer describes several zones in the lithological sequence. The alterites (regolith) consist of weathered and decayed rock; their permeabilities vary in accordance with lithology but are usually low; they play the major part of the storativity in the aquifer. The underlying weathered-fissured zone (saprock) and the fractured bedrock present typically low storativity, but permeability commonly increases at lower levels due to a lesser development of secondary clay minerals and a high permeability of open fractures.

There are a number of important constraints to the development of bedrock aquifers. The failure rate of low-yield boreholes for rural water supply is high in the drier regions (typically in the range of 40 to 50%), and the implementation of high-yield boreholes for urban or irrigation purposes is always a challenge for hydrogeologists. Furthermore, the low storativity of bedrock aquifers often leads to unsustainable yield of boreholes.

Therefore, there is an important need both to improve the current methodology for high-yield borehole implementation and to assess more accurately the overall resources and aquifer occurrence to assist development efficiency and sustainable long-term use of the aquifer.

#### 2.1.2 EQUIPMENT AND METHODS

Bedrock aquifers are of significant extent in Burkina Faso (around 80% of the total country surface area). To measure the contribution of the MRS method to characterise these aquifers, a survey was conducted from November 2002 to January 2003 in granite and associated rocks of Precambrian age.

MRS were carried out around recent boreholes drilled in the alterites, in the weathered-fissured zone and in fractured bedrock. All of the 13 boreholes were tested with well-test pumping tests (total pumping duration of 4 hours), and 6 of them were used to conduct aquifer tests (pumping duration of 72 hours).

The aquifers' local transmissivities were calculated from the recovery period of well-tests, and the storativities were calculated from piezometer records with Theis and Jacob methods. The geometry of the aquifers was deduced from borehole reports and the static water level was measured while implementing the MRS. The NumisPlus® equipment was used to set up the MRS with a square loop of a typical 150 m side. The adapted saturation recovery method was used to measure the longitudinal relaxation time, and the storativity and transmissivity of the aquifers were estimated from MRS as:

$$n_{e_{MRS}} = 0.28 \cdot w$$

$$S_{MRS} = 4.3 \cdot 10^{-3} \cdot (w \cdot \Delta z)$$

$$T_{MRS} = 3 \cdot 10^{-7} \cdot (S_{MRS} \cdot (T_1^*)^2)$$

where  $n_{e_{MRS}}$  is the specific yield of unconfined aquifer (%),  $S_{MRS}$  is the storage coefficient of confined aquifer,  $T_{MRS}$  is the MRS transmissivity ( $m^2/s$ ),  $w$  and  $\Delta z$  are respectively the MRS water content (%) and saturated thickness (m), and  $T_1^*$  is the observed longitudinal relaxation time (ms).

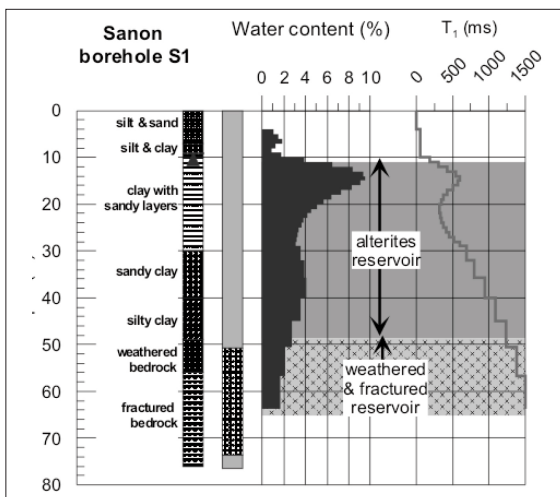
## 2.2 Main results

### 2.2.1 RESERVOIR TYPOLOGY

Field results obtained in Burkina Faso show that the reservoir type could be estimated from MRS data. Table 5.XVII and Figure 5.76 indicate that the average value of water content is higher and the average value of longitudinal relaxation time shorter for water in alterite reservoirs than for water in fissured-fractured reservoirs. It means that the storativity is higher and the transmissivity is lower for the alterites than for the fissured-fractured zones, which is in accordance with the typical hydrogeological conceptual model. However, the values margins are large and ambiguity still remains when interpreting the MRS data alone.

**Table 5.XVII: MRS parameter and reservoir type.**

Reservoir	Water content (%)			Max.	$T_1^*$ (ms)	
	Max.	Average	Min.		Average	Min.
Alterites	6	3	1	600	400	180
Fissured-fractured bedrock	2.5	1	0.2	1 500	650	350



**Figure 5.76: MRS and reservoir units, example of Sanon S1 borehole.**

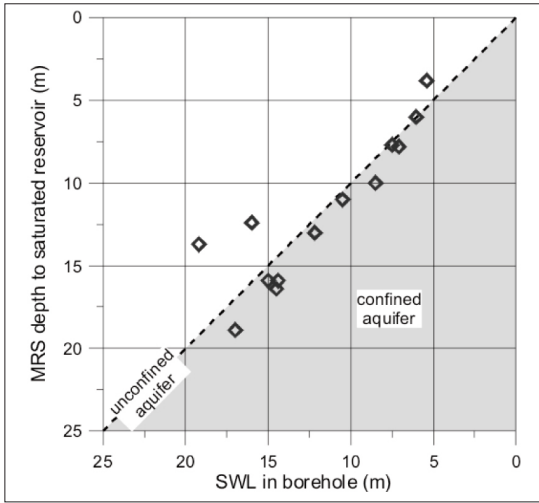


Figure 5.77: MRS and static water level (SWL).

### 2.2.2 RESERVOIR GEOMETRY

The depth to water-saturated layers obtained by MRS could be compared with the borehole static water level for an unconfined aquifer (Figure 5.77). The average difference with borehole data is +/- 12%, and +/- 17% for the depth to the unweathered bedrock (Figure 5.78). This characterisation can be used to contribute to both a better implementation of a borehole (thickest alterites reservoir) and an evaluation of the resource (spatial extent of reservoir).

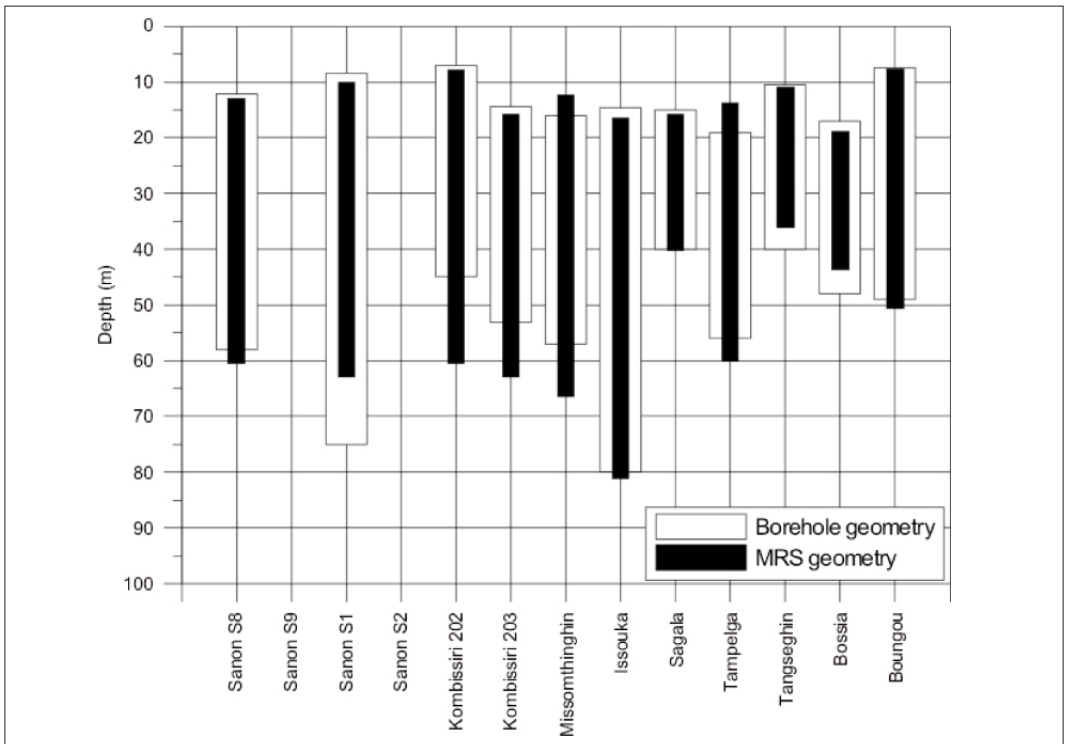
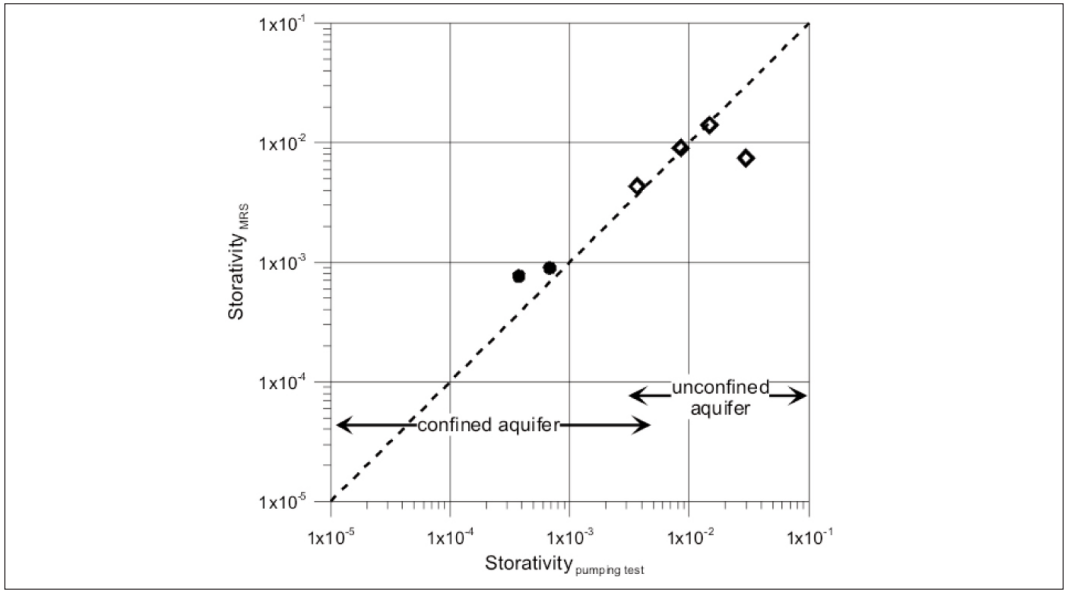


Figure 5.78: MRS and reservoir geometry.



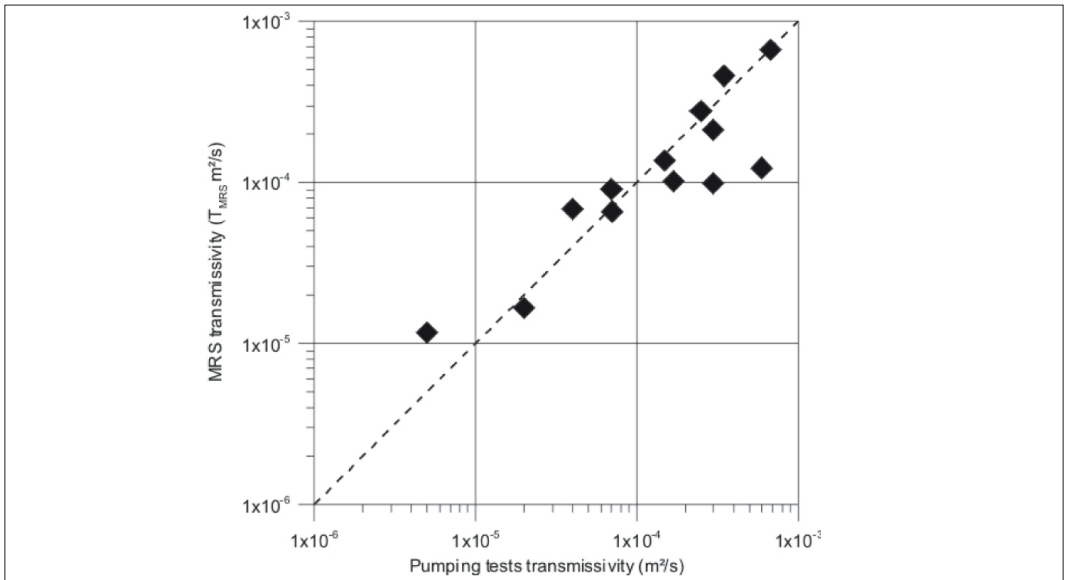


**Figure 5.79: Aquifer storativity.**

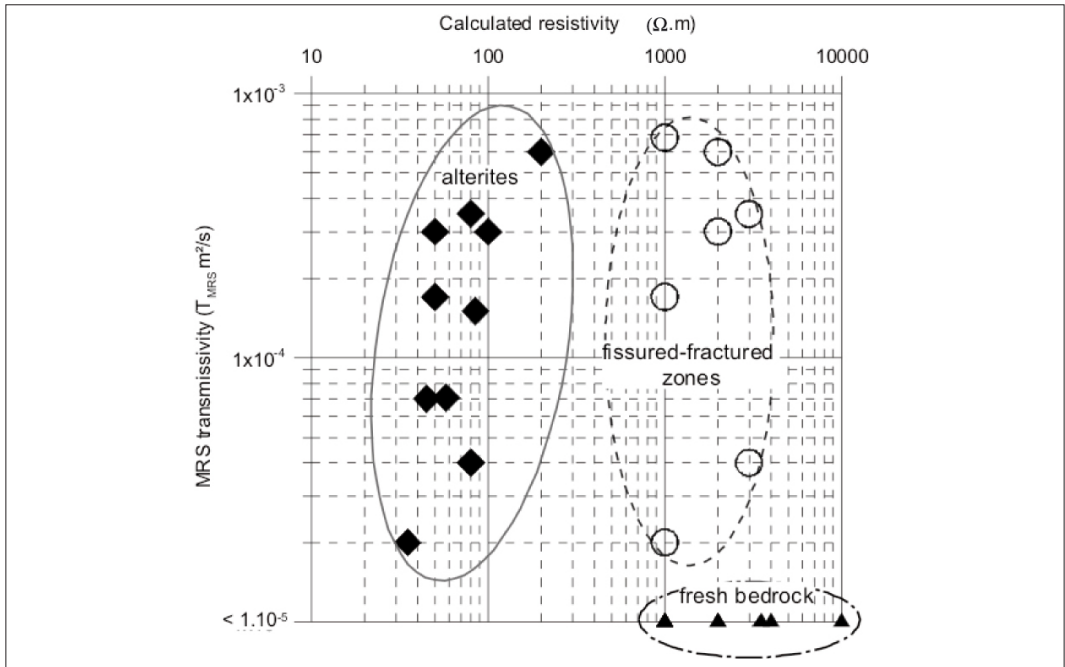
### 2.2.3 RESERVOIR HYDRAULIC PARAMETERS

The hydraulic properties of the aquifer were estimated after a calibration process with the borehole pumping-test results.

The average difference with properties calculated from pumping-test data are  $\pm 80\%$  for the storativity (Figure 5.79) and  $\pm 41\%$  for the local transmissivity (Figure 5.80). These first results still need to be confirmed with more data, but they are very encouraging and allowed ACF to propose using MRS as an interpolation tool between boreholes to estimate the hydraulic characteristics of the reservoirs.



**Figure 5.80: Aquifer local transmissivity.**



**Figure 5.81: Joint use of resistivity and MRS transmissivity to characterise reservoirs.**

#### 2.2.4 IMPROVEMENT OF THE AQUIFER CHARACTERISATION

The characterisation of an aquifer is improved if the MRS results are jointly interpreted with electrical resistivity methods. If MRS resolution is not sufficient in depth, one-dimensional electrical soundings are often able to measure the depth of the substratum. In heterogeneous contexts, ERI can highlight the structures of the aquifers.

With the available data, the type of reservoir is well estimated when it is jointly characterised with its electrical resistivity and its MRS transmissivity (Figure 5.81).

#### 2.2.5 MAIN LIMITING FACTORS

The main limiting factors of MRS in such geological contexts are (1) the time required for data collection, which ranges from 6 to 20 hours due to the low signal-to-noise ratio, (2) the one-dimensional measurement, which does not allow description of the reservoir structure over a scale corresponding to the loop size, and (3) the loss of resolution with depth, which does not allow measurement of small signals coming from deep productive fractures (Figure 5.82).

This suppression effect particularly affects the fractures deeper than half of the Tx/Rx side length, with low weathered development. Figure 5.82 shows an example where the fractures identified from an electrical borehole log below 40 m deep are not measured by the MRS carried out with a 75 m side loop (square shape).

### 2.3 Conclusion

- The main conclusions of the comparison between the MRS results and the borehole data are:
- the geometry of the weathered part of the aquifer is well described by MRS;
  - storativity and transmissivity can be reasonably estimated from MRS data after calibration with borehole pumping-test results;

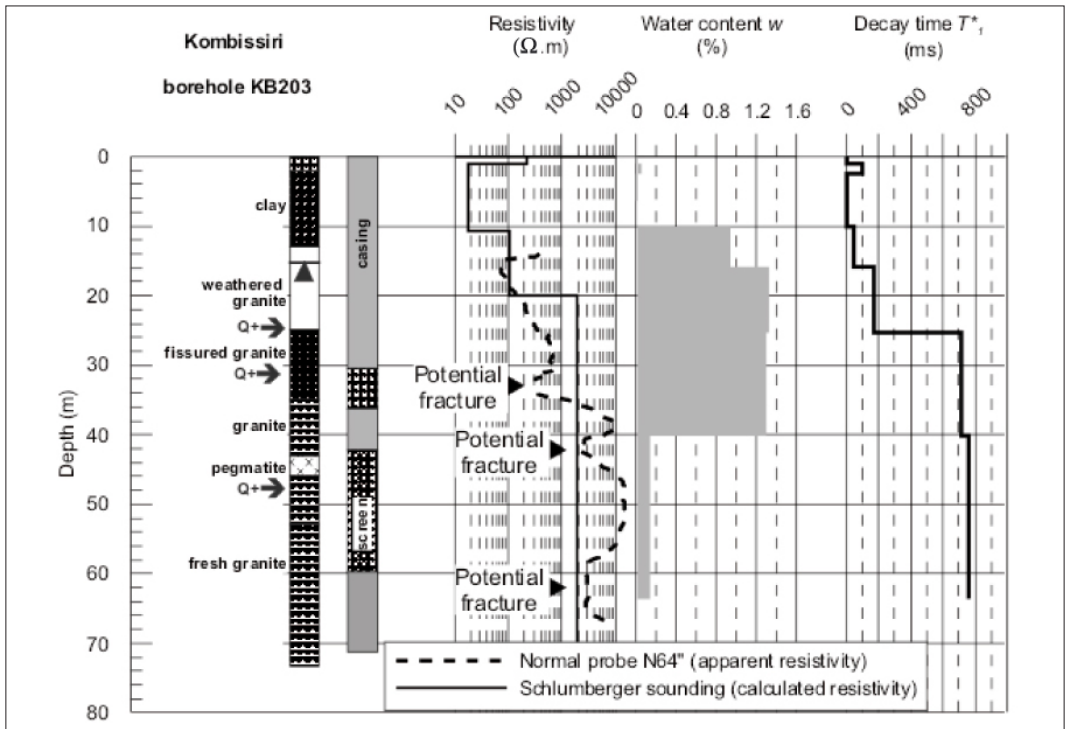


Figure 5.82: Suppression, example of Kombissiri borehole #203.

- the main limitations of MRS are the one-dimensional approximation in highly heterogeneous contexts and the loss of resolution when looking for deep narrow fractures;
- MRS is a useful tool to characterise aquifers in a crystalline context. Its use within a hydrogeological process is a promising support for hydrogeologists for both borehole implementation and estimation of water reserves (see Chapter 5A).

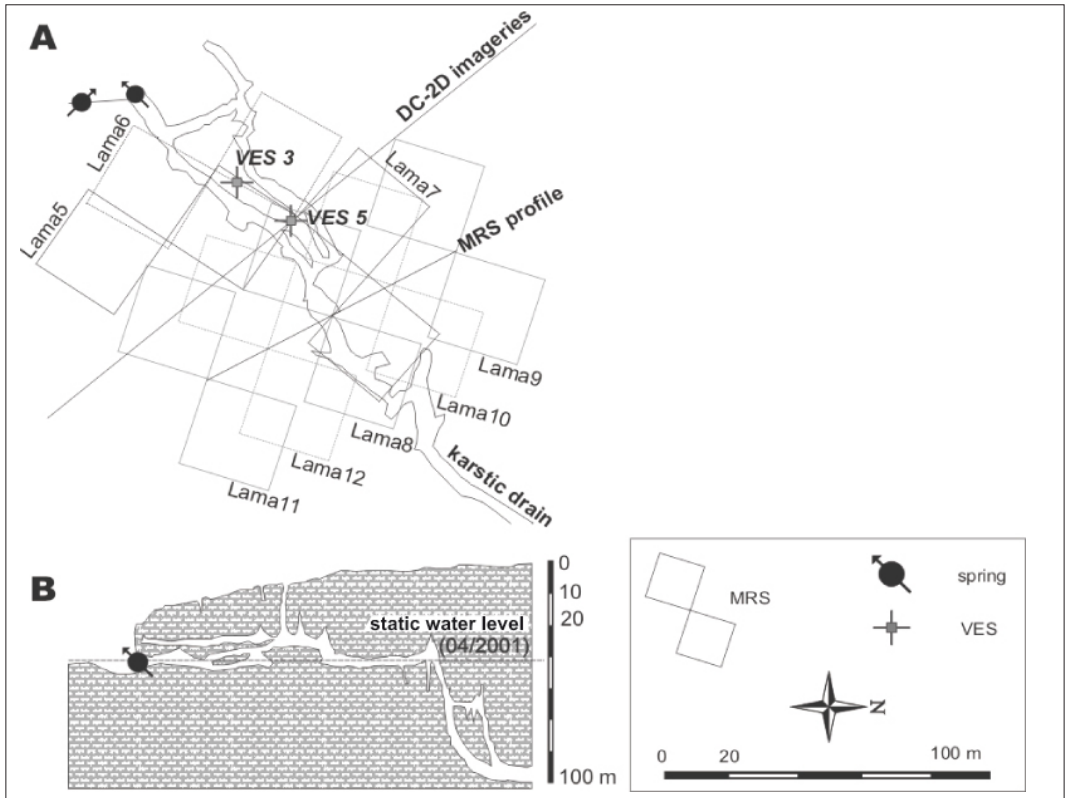
### 3 Localisation of saturated karst aquifers

The exploitation and management of a karstic aquifer is often a challenge to hydrogeologists. Whatever the stage is when karstified, the heterogeneous structure of karstic systems leads to a complex hydrodynamic behaviour, and this groundwater resource is difficult both to explore for borehole implementation and to protect from pollution. Therefore, specific surveys need to be done to develop and protect these resources for the benefit of everyone. With this in mind, a methodological project was set up between ACF, IRD, the *Bureau de Recherche Géologique et Minière* (BRGM) and the University of Montpellier to evaluate the impact of geophysics on karstic-aquifer investigation.

#### 3.1 Background

##### 3.1.1 PHYSICAL ENVIRONMENT

The Lamalou site is located on the Hortus karstic area, 40 km north of the French city of Montpellier. This limestone plateau covers an area of about 50 km<sup>2</sup>, and its elevation ranges from 195 to 512 m above sea level. It mainly features limestone outcrops, and soil only exists in rock fissures. It is covered with Mediterranean shrubby vegetation. There is no regular surface-water running on the plateau.



**Figure 5.83: The known conduit system of Lamalou karst, and location of geophysical surveys. A: map. B: cross-section along the conduit.**

The Hortus area consists of Upper Valanginian limestone, 80 to 110 m thick, which lies on Upper Berriassien to Lower Valanginian marl. The main recharge area of the Hortus plateau discharges at the Lamalou spring.

The main aquifer is the Upper Valanginian limestone. Its upper part (several metres thick) is highly fissured and weathered: this is the epikarst, which can be saturated in places (see Chapter 3). Under the epikarst, an infiltration zone about 20 m thick drains the water through micro-fissures and joints down to the saturated karst. The porosity of the limestone is very low (1.8%) and the groundwater mainly flows through fissures, fractures and karst conduits. Part of the main conduit was explored and mapped by speleologists (Figure 5.83).

### 3.1.2 SURVEY OBJECTIVE AND METHODOLOGY

A methodological test was conducted, jointly using MRS and ERI. The main objective was to check how MRS and ERI could help the hydrogeologist to look for groundwater in karst. The specific objectives were to check if MRS could measure and differentiate between the water in the epikarst and the water in the saturated karst, and ERI sensitivity to karstic caves.

Eight MRS and two ERI were carried out on a known system where the depth and the geometry of the main conduit and a cave are mapped (Figure 5.83). Two boreholes were used to measure the static water level and the lithology was known through the drilling logs.

The common hydrogeological parameters, such as permeability or porosity, that are defined for porous media are not usable for karstic systems, which are highly heterogeneous. However, a

qualitative approach could be used to identify the karstic structures because all karstic zones have their own particular geophysical response: the MRS water content and relaxation time are higher for conduits and caves containing water (secondary porosity) than for compact rocks (primary porosity), and the electrical resistivity of empty caves should be infinite compared to the high resistivity of carbonate rocks or to the medium resistivity of saturated structures.

Thus, two MRS estimators  $k_x$  (permeability estimator) and  $T_x$  (transmissivity estimator) that are normalised MRS permeability and transmissivity could be used to differentiate water in saturated dissolution features (i.e. conduits and caves) from unsaturated and epikarstic zones (Figure 5.84) :

$$k_x(z) = \frac{w_x(z)T_{1x}^2(z)}{w_r(z)T_{1r}^2(z)}$$

$$T_x = \frac{\int_z w_x(z)T_{1x}^2(z)dz}{\int_z w_r(z)T_{1r}^2(z)dz}$$

where  $x$  and  $r$  are two of  $N$  MRS soundings ( $1, \dots, x, \dots, r, \dots, N$ ). The reference  $r$  is selected as  $\{k_{x_{\max}}(z) \leq 1\}$  or  $\{T_{x_{\max}} \leq 1\}$  for all soundings ( $x = 1, \dots, N$ ).

The capability of MRS to detect water according to depth and volume of saturated zone was investigated using  $T_1 > 400$  ms as the indicator of dissolution features. Model results show that water in saturated dissolution features can be easily identified at shallow depths (Figure 5.85). For deeper investigation, a larger volume of water is necessary: 100 m<sup>3</sup> of water is detectable at 5 m deep, whereas at 15m, at least 250 m<sup>3</sup> is required for MRS detection.

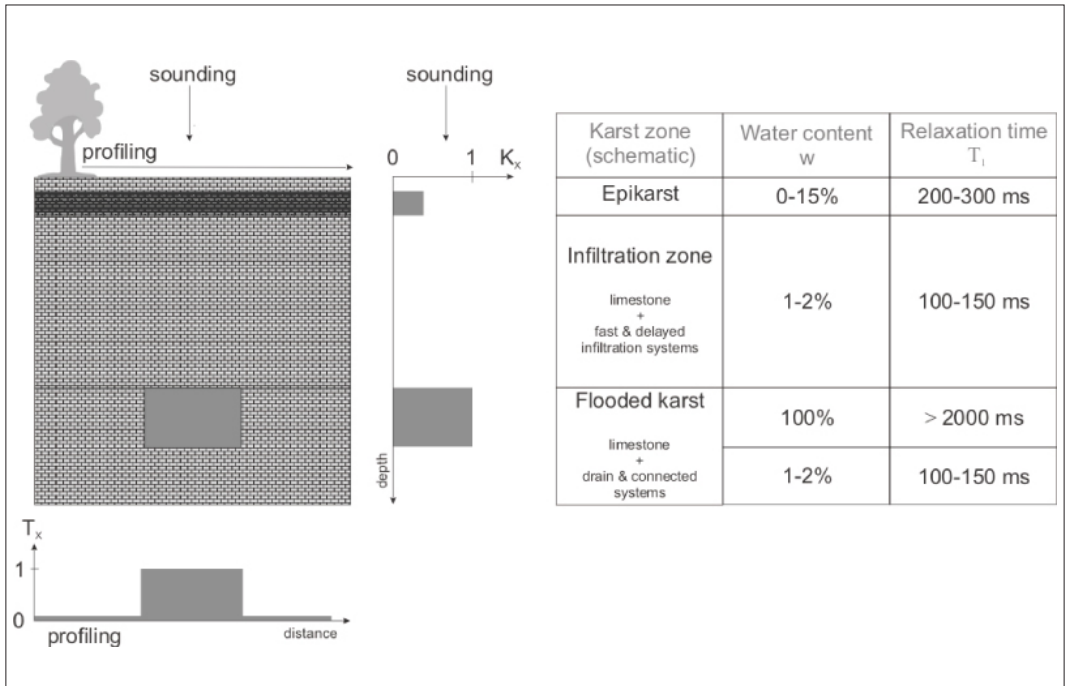


Figure 5.84: MRS estimators as tools to detect saturated karst structures.

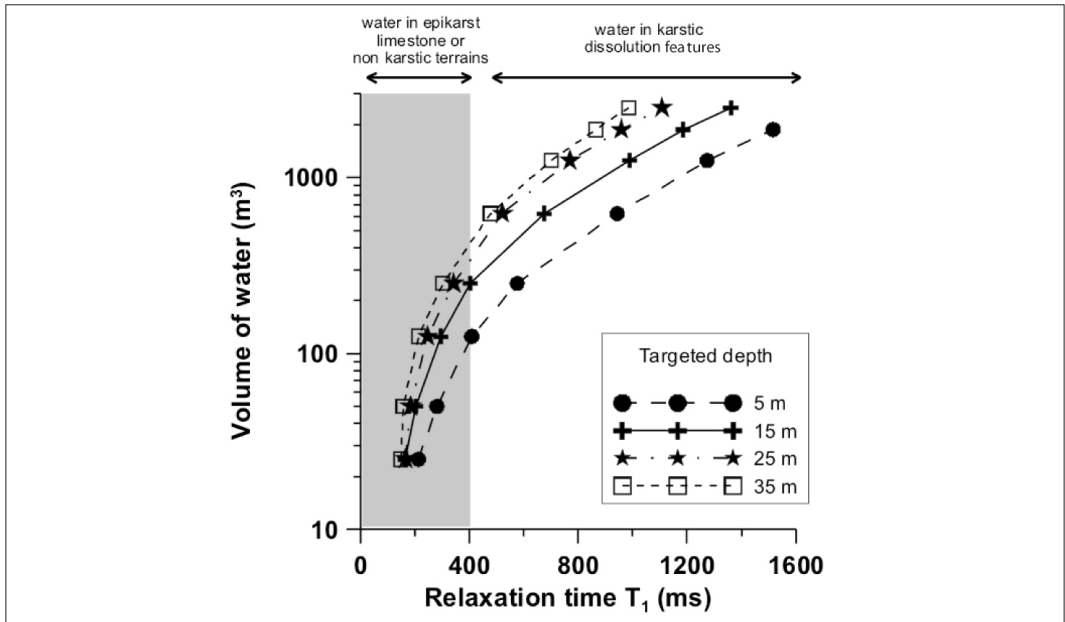


Figure 5.85: Required volume of free water ( $w=100\%$  &  $T_1=1500$  ms) for MRS measurements in a karstic environment ( $w=1\%$  &  $T_1=150$  ms).

## 3.2 Field example

### 3.2.1 MRS SATURATED KARST LOCALISATION

The NumisPlus® equipment developed by IRIS Instruments and BRGM, and the inversion software ‘Samovar’ were used. An eight-shape loop was used to improve the signal-to-noise ratio, leading the estimation of the investigated volume to be a parallel pipe of 120 x 50 x 50 m. A clear limitation of using MRS, which is a one-dimensional sounding method, to investigate a two-or three-dimensional target, is that it averages the information over the antenna size. To obtain two-dimensional pictures, triangulations with linear interpolation of MRS data were prepared (Figure 5.86).

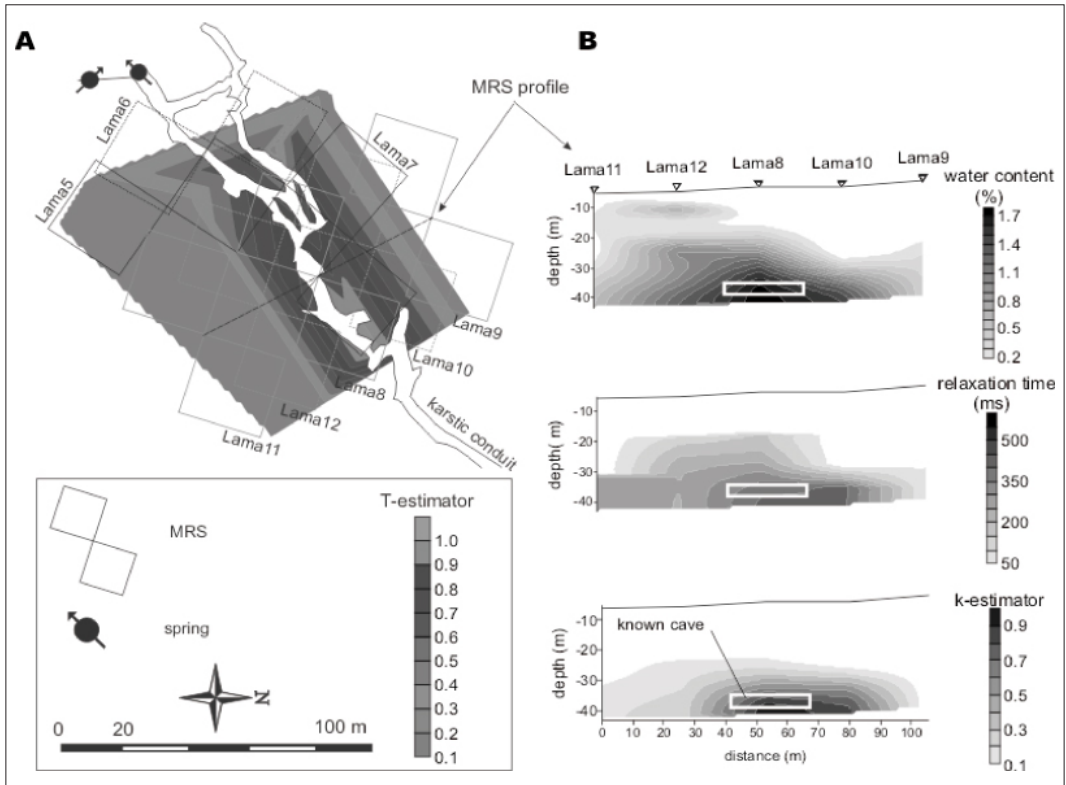
#### *Karst mapping*

The map was drawn using a T-estimator calculated with the MRS Lama7 as reference (Figure 5.86A). It clearly shows a high-transmissivity channel which fits well with the known karstic conduit. The contribution of the different MRS to the map, i.e. their ability to measure groundwater, is linked to the location of the Tx-Rx loop. If the loop surface-area covers enough groundwater, the magnetic-resonance signal can be measured (Lama7, 8, 10), but if the loop only partly covers groundwater, the signal can be too low to be measured (Lama5 and 6).

#### *Karst pseudo section*

The water content ranges between 0 and 1.7% (Figure 5.86B). The maximum is reached around the known conduit and represents a thickness of about 1.5 m of water filling the width of the conduit. A second domain extends a few metres below the ground surface for a maximum water content of 0.6% reached around the Lama12 MRS. It could represent the well-known perched saturated area in the epikarst.

The relaxation time section (Figure 5.86B) indicates relaxation times longer than 400 ms for



**Figure 5.86: MRS Karst localisation.**

**A: conduit mapping using T-estimator. B: cross-section using k-estimator.**

the known conduit area, and shorter than 400 ms for the epikarst and the limestone.

### 3.2.2 ERI KARST STRUCTURE ESTIMATION

Two ERIs were carried out with the Syscal® R2 system from IRIS instruments with 64 electrodes and an inter-electrode spacing of 4 m. The data was interpreted with RES2DINV software.

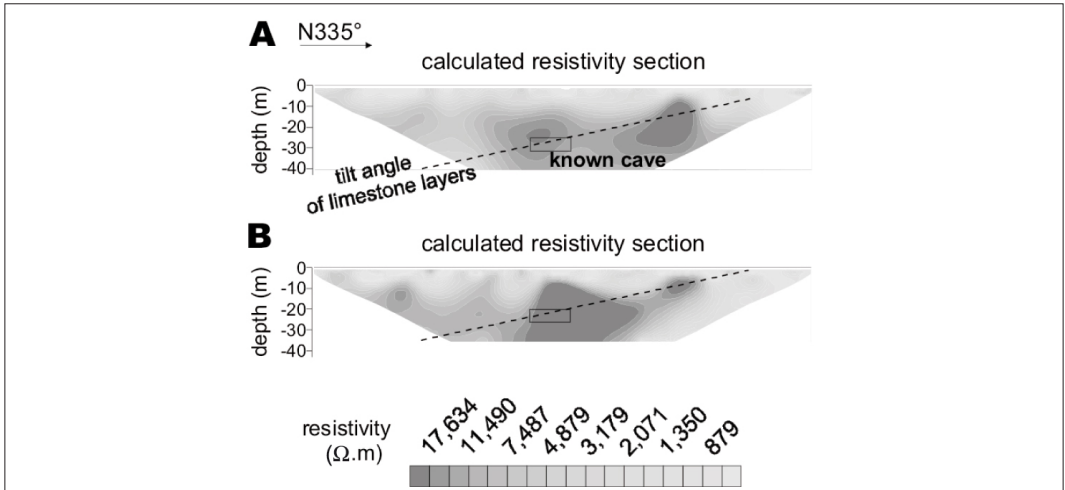
Figure 5.87 presents the inversion of the Wenner imageries. Two resistive anomalies of 20 000  $\Omega$ .m located at between 10 and 30 m depth fit quite well with the known cave and with the tilt angle of limestone layers measured both on the outcrops and in the cave itself. However, forward modelling was conducted, which showed that the cave itself could not be identified by ERI. What could be identified was the fracture that stretched from the top of the cave to the surface, and which created an identifiable resistivity anomaly.

## 3.3 Conclusion

MRS is a useful tool which could have a place in the hydrogeologist's toolbox for karst applications because it can estimate the spatial variations of permeability and transmissivity which underline karstic structures bearing water (such as epikarst, conduits and caves). However, the groundwater quantity has to be enough to send out a signal which can be measured. For practical purposes, the hydrogeologist can use Figure 5.85 to estimate if the geological target can be detected with MRS, i.e. if the groundwater quantity and depth lead to a measurable signal.

One should also keep in mind that the geometry of the three-dimensional structures can only





**Figure 5.87: ERI interpretation.**  
**A: Wenner array. B: dipole-dipole (Wenner beta).**

be approximated with one-dimensional soundings.

For low magnetic signals, i.e. small amounts of water, or water at great depths, the measurement duration of a MRS can reach up to 20 hours (several hundreds of stacks): in a karstic environment, an average of one sounding per day should be planned.

In such a highly resistive context, ERI can measure the signal induced directly by the geological structures down to about 10 m (with the array used). Deeper dissolution structures such as a cave or conduit can be localised if they are associated with shallower anomalies such as fractures.

At the Lamalou site the ground surface is basically limestone. Therefore, to set up the electrodes properly, it was necessary to drill holes into the rocks and fill them with a clayey mixture to secure a proper contact. This was time-consuming, and an average of only one image could be completed per day.





# Pumping test

<b>1</b>	<b>Aquifer test</b>	212	2.2.1	<i>Simplified method</i>	229
1.1	Diagnostic graphs	212	2.2.2	<i>Calculation of corrected drawdowns</i>	230
1.1.1	<i>Aquifer categories</i>	212	2.2.3	<i>Graphical estimation of corrected drawdowns</i>	231
1.1.2	<i>Boundary conditions</i>	213	2.2.4	<i>Data validation and interpretation</i>	231
1.1.3	<i>Data validation</i>	214	<b>3</b>	<b>Pumping-test procedure</b>	233
1.2	Choice of model	215	3.1	Design of test	233
1.3	Jacob's method	215	3.1.1	<i>Maximum drawdown and pumping rate</i>	233
1.3.1	<i>The logarithmic approximation</i>	216	3.1.2	<i>Well test: number and duration of steps</i>	233
1.3.2	<i>Estimation of the hydraulic parameters</i>	216	3.1.3	<i>Aquifer test: duration of pumping</i>	235
1.3.3	<i>Superposition principle</i>	217	3.1.4	<i>Number and position of piezometers</i>	235
1.4	Theis's recovery method	218	3.2	Test implementation	236
<b>2</b>	<b>Well test</b>	219	3.2.1	<i>Verification of site</i>	236
2.1	Non-connected steps	219	3.2.2	<i>Equipment required</i>	236
2.1.1	<i>Standard method</i>	219	3.2.3	<i>Human resources</i>	237
2.1.2	<i>Data validation and interpretation</i>	220	3.2.4	<i>Test monitoring</i>	237
2.1.3	<i>Examples</i>	225	3.3	Reporting	238
2.2	Connected steps	228			

When a borehole or a well has been completed, it is essential to verify that its capacity meets the water needs of the population. When a well or borehole is to be exploited, there are recurrent questions as to how much water can be pumped, at what intervals, with what type of pump, and at what depth. A well-conducted pumping test generally provides the answers to these questions.

Also, observation of the effects of pumping is one of the best investigative methods in hydrogeology. Pumping tests enable better knowledge of the aquifer and better targeting of activities.

There are two types of test aiming to fulfil different objectives:

- The aquifer test (also known as the constant-discharge test) estimates the hydraulic parameters of the aquifer. The information obtained is usually the transmissivity of the aquifer (subsequently used to calculate the hydraulic conductivity), the storativity (the storage coefficient if the aquifer is confined, or the specific yield if it is unconfined), the radius of influence of pumping, and the boundary conditions.

This test requires pumping at a constant rate and monitoring of the water level in an observation well over several days. It is therefore difficult and relatively expensive to implement. In the context of humanitarian programmes, it is justified on boreholes intended for high flow-rates, or in investigations to determine the hydrodynamics of a zone.

- The well test (also known as step test or step-drawdown test) evaluates the characteristics of the well and its immediate environment. Unlike the aquifer test, it is not designed to produce reliable information concerning the aquifer, even though it is possible to estimate the transmissivity of the immediate surroundings of the catchment. This test determines the critical flow rate of the well, as well as the various head-losses and drawdowns as functions of pumping rates and times. Finally, it is designed to estimate the well efficiency, to set an exploitation pumping rate and to specify the depth of installation of the pump.

This type of test is especially useful in determining whether the well meets users' needs. It also helps to specify limits of exploitation of the well and to obtain data relevant to the consideration of possible rehabilitation, or of new extraction methods (for example, replacement of a handpump by an electric submersible pump).

Whatever the pumping test, the main field data recorded are the pumping rate, the water level and the time (or duration). These data need to be verified before interpretation. Interpretation consists of comparing the field record with theoretical well-flow equations.

## 1 Aquifer test

The aquifer test is used to determine the aquifer hydraulic characteristics and, in some instances, boundary conditions :

- transmissivity;
- storativity, that is specific yield for an unconfined aquifer, storage coefficient for a confined aquifer or specific drainage for a confined aquifer that is desaturated by water abstraction;
- boundary conditions such as recharging or barrier boundaries;
- heterogeneity and anisotropy of reservoirs.

An aquifer test involves pumping from a well at a constant discharge rate and measuring the drawdown in the pumping well and in piezometers (observation wells) at known distances from the well. The interpretation of these field measurements involves entering the observed data into an appropriate well-flow equation to calculate the hydraulic characteristics of the aquifer.

There is a wide range of methods and equations that could be used according to the aquifer type, boundary conditions and test procedure. The appropriate method can be selected with the support of diagnostic graphs.

### 1.1 Diagnostic graphs

Theoretical models used to interpret field data take into account the type of aquifer, the well conditions and the boundary conditions. These parameters affect the drawdown behaviour of the system in their own individual ways, so that to identify an aquifer system, one must compare its drawdown behaviour with that of various models. The model that compares best with the data should be selected to calculate the hydraulic characteristics of the aquifer.

System identification includes the construction of diagnostic log-log and semi-log plots, while interpretation of the data includes construction of specialised semi-log plots. The diagnostic graphs represent drawdowns against time (or against distance); they help to identify the flow regime and their shape leads to selection of the appropriate model of interpretation.

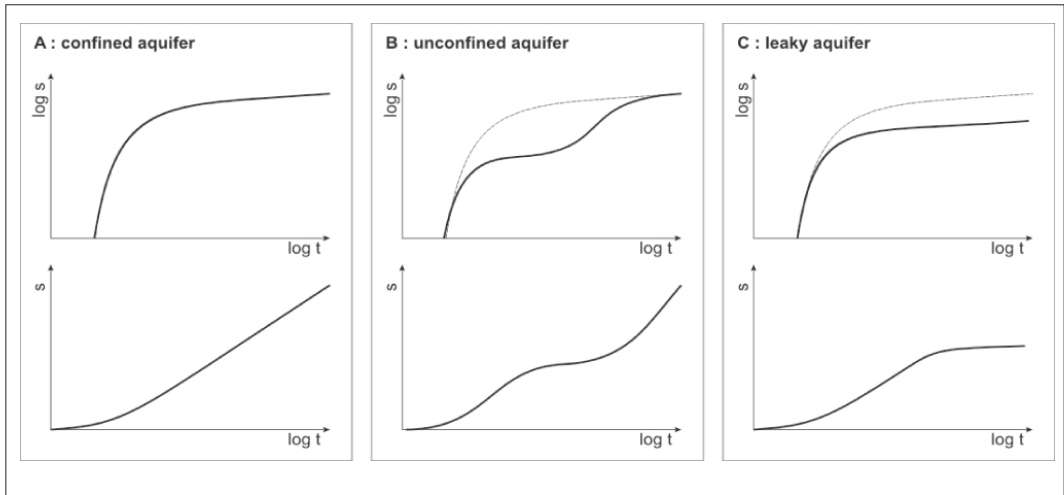
It is therefore recommended that diagnostic graphs are drawn before selecting an interpretation method.

#### 1.1.1 AQUIFER CATEGORIES

For pumping-test analysis, the aquifer can be classified as follows: unconsolidated or fractured; and confined, unconfined or leaky. Figure 6.1 shows diagnostics graphs of the main unconsolidated categories of aquifer.

Graph 6.1A represents an unconsolidated, confined, homogeneous and isotropic aquifer. This represents the ideal curve that is the reference used to understand others. From a semi-log plot, one can see that the time/drawdown relationship becomes linear. This linearity is used to calculate hydraulic characteristics accurately (see Jacob's method).

Graph 6.1B shows diagnostic graphs obtained in an unconfined, homogenous and isotropic aquifer. Initially, typically for the first few minutes of pumping, the curve is the same as that for a



**Figure 6.1: Theoretical diagnostic graphs of aquifer type showing drawdown ( $s$ ) against time ( $t$ ). The dashed curves are those of the ‘ideal confined aquifer’ as represented on graph A (Kruseman & de Ridder, 2000).**

confined aquifer because the release of water is dominated by the storage coefficient. The flat segment midway along the curve corresponds to the delayed yield-effect characteristic of an unconfined aquifer: this reflects the recharge from overlying horizons by a specific-yield effect that takes more time than the storage coefficient to release water. Finally, the curve follows a similar path to graph 6.1A as the flow is again mainly horizontal.

This drawdown development is also one of a double-porosity system. Initially, the flow comes mainly from storage into fractures until the storage in the matrix starts to feed the fractures.

Graph 6.1C shows a leaky aquifer. After the initial stage, which is similar to that in a confined aquifer, more and more water is produced by the aquitard, and this reduces the development of drawdown.

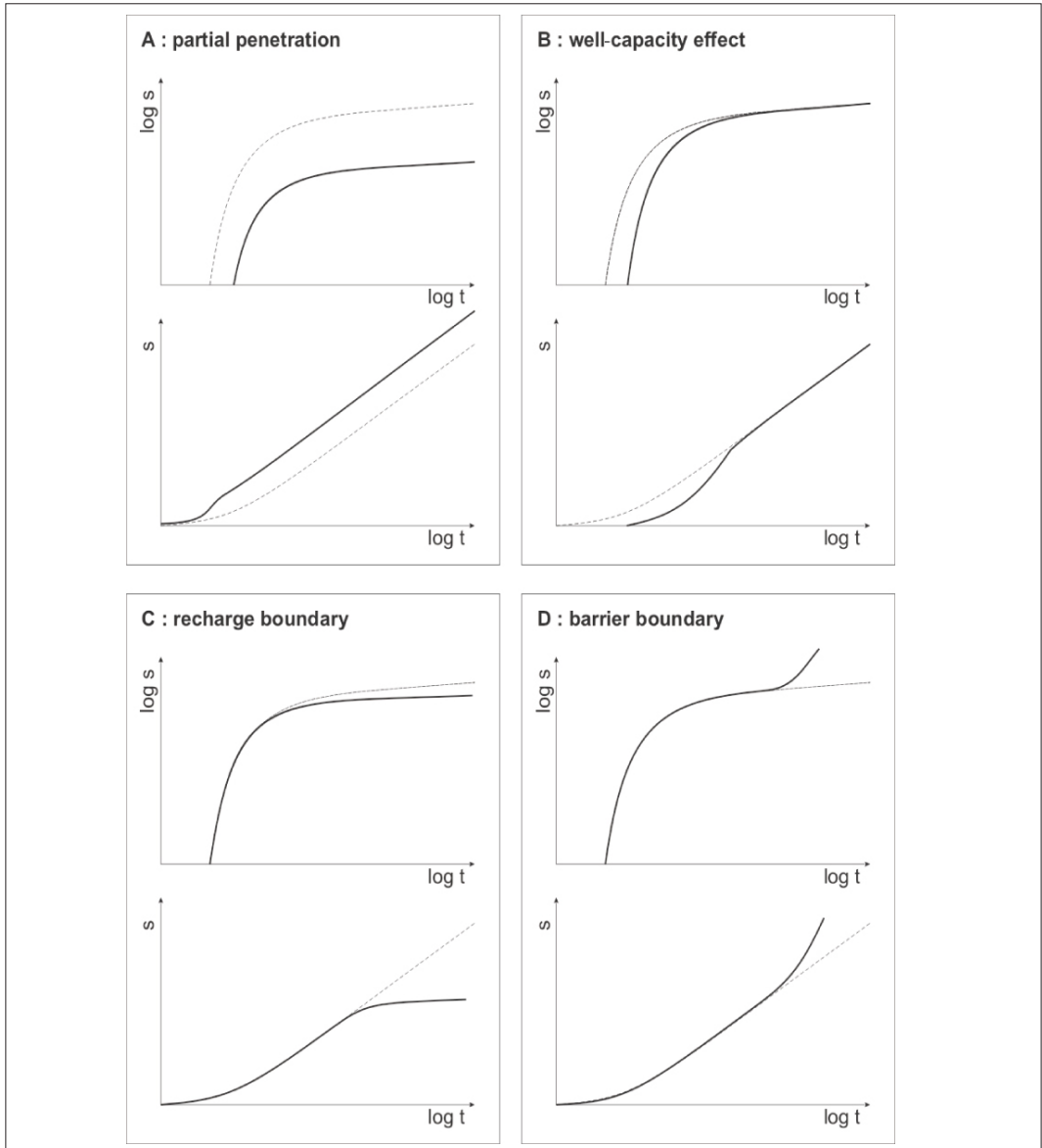
### 1.1.2 BOUNDARY CONDITIONS

When field data curves deviate from those of theoretical aquifer types, the deviation is usually due to specific boundary conditions (Figure 6.2).

Graph 6.2A shows the effect of a partially penetrating well. In this case, the condition of horizontal flow in the vicinity of the well does not apply, and vertical flow induces extra head-losses.

The well-capacity effect measured at a piezometer (observation well) is shown in graph 6.2B. This corresponds to the difference between the drawdown due to pumping in an ideal well of negligible diameter, and drawdown in a real well containing a non-negligible volume of water. At the beginning of pumping, the capacity effect is induced by the delay in demand on the aquifer, because it is water stored within the well that is extracted first. The capacity effect therefore results in a delay of drawdown at the beginning of pumping if the water level is measured in a piezometer (observation well). On the other hand, the capacity effect can be seen as an exaggeration of the drawdown at the beginning of pumping if the water level is measured directly in the pumping well. Its duration depends on the dimensions of the well and the transmissivity of the aquifer (see Section 3).

When the cone of depression reaches a hydraulic boundary, the field curve deviates from the theoretical one according to the type of boundary. For a recharge boundary, such as a river for example, the drawdown will stabilise (graph 6.2C); for an impermeable boundary, such as a dike, the slope of the drawdown on the semi-log plot will double (graph 6.2D).



**Figure 6.2: Theoretical diagnostic graphs of boundary conditions showing drawdown ( $s$ ) against time ( $t$ ). The dashed curve are those of the ‘ideal confined aquifer’ of Figure 6.1A (Kruseman & de Ridder, 2000).**

Heterogeneity and anisotropy of aquifers have effects on drawdown development as the cone of depression reaches zones of different hydraulic characteristics. The effects can be in both directions: either drawdown slows down if the newly reached hydraulic properties are higher, or it speeds up if the hydraulic properties are lower.

### 1.1.3 DATA VALIDATION

Before interpreting the field data, it should be examined to see if measurements have been affected by external changes other than the test pumping, or if some are obviously wrong.

The observation of the diagnostic graphs  $s=f(t)$  together with the plot  $Q=f(t)$  is the best way to verify data. The most likely external effects are barometric changes, tidal effects, pumping from other wells and short-term rainfall recharge. These affect the water level and invalidate simple analysis. External effects should be avoided, or if this is impossible (i.e. tides) the measured water levels should be corrected.

## 1.2 Choice of model

The appropriate interpretation method is selected according to the type of system and the boundary conditions previously known, or shown by the diagnostic plots (Table 6.I).

It is often helpful to test different methods on the same data set to get a feel of the context. For this purpose, the use of software such as AquiferTest Pro is interesting because it is time-saving (<http://www.flowpath.com>). This commercial software is recommended by ACF because it is easy to use and offers several interpretation methods including forward modelling for both well tests and aquifer tests. It allows for the testing of different interpretation solutions with the same data set, and beside the common automatic fitting, the user can always take back the control of the interpretation.

However, manual interpretation by drawing specialised curves and using adapted nomograms is always an efficient and easy process.

**Table 6.I: Some of the main methods used for non consolidated aquifer test interpretation.**

Flow	Type of aquifer	Boundary conditions	Main methods
Steady -state	Confined	—	Thiem
Unsteady-state	Confined	—	Theis Jacob
		Partially-penetrating well Large-diameter well	Hantush modification of Theis method Papadopulos
	Unconfined	—	Neuman Jacob with some restrictions
		Partially-penetrating well Large-diameter well	Neuman Boulton-Strelsova
	Leaky	—	Walton Hantush
	Recovery	Confined	—
Unconfined		—	Theis recovery
Leaky		—	Theis recovery

The methods are described in the main references cited in this chapter, and their detailed explanation is beyond the scope of this book. The only methods which are presented here are the ‘Jacob’ and ‘Theis recovery’ methods because they can be used in several contexts with some precautions.

## 1.3 Jacob’s method

This method of pumping-test interpretation is frequently used because it is simple to handle: it does not need specific type curves, and the only specific graphs needed for interpretation are semi-log graphs which will already have been drawn for diagnostics. However, the following conditions under-

lying the method need to apply to obtain realistic interpretation results:

- The method can be used rigorously only if the aquifer is confined. If it is unconfined, Jacob's method can still be used:
  - if the maximum drawdown is negligible compared to the thickness of saturated layers;
  - if the measured drawdowns are corrected with the appropriate formula  $s_c = s - (s^2/2 \cdot D)$  where  $s_c$  is the corrected drawdown,  $s$  is the measured drawdown and  $D$  is the original saturated thickness (Kruseman & de Ridder, 2000).
- The aquifer is homogeneous, isotropic, of the same thickness throughout the area affected by pumping and of infinite area extent. These ideal conditions are rarely fulfilled in the field, but the diagnostic graphs can show if this assumption is reasonably met.
- The piezometric surface before pumping is almost horizontal.
- The release of water by the porous environment is instantaneous.
- The well is perfect, in that it penetrates the entire thickness of the aquifer, and its radius is small enough not to be affected by the well-capacity effect. The diagnostic graphs can show if this assumption is reasonably met.
- The pumped flow rate is constant.
- The flow state is unsteady.
- The pumping time is sufficiently long. This condition always needs to be checked (see following section).

These conditions are rarely all fulfilled on site. It is therefore wise to be careful in the application of this method, and to use common sense in the interpretation of diagnostic graphs.

### 1.3.1 THE LOGARITHMIC APPROXIMATION

Under transient flow conditions (when flow is variable over time and drawdown is not stabilised), drawdown at any point in the aquifer is given by the so called unsteady-state or Theis's equation:

$$s = \frac{Q}{4 \cdot \pi \cdot T} \cdot W(u)$$

where  $u = r^2 \cdot S / 4 \cdot T \cdot t$ ,  $W(u)$  is a known and tabulated function (table, nomogram),  $s$  is drawdown measured in a piezometer at a distance  $r$  from the pumping well (m),  $Q$  is pumped flow rate ( $m^3/h$ ),  $T$  is transmissivity ( $m^2/h$ ),  $t$  is pumping time (h),  $S$  is the storage coefficient, and  $r$  is the distance of a given point from the axis of the pumped well (m).

When  $t$  is sufficiently large, a logarithmic approximation known as Jacob's approximation can be applied to the Theis equation such that:

$$s = \frac{0.183 \cdot Q}{T} \cdot \log \left( \frac{2.25 \cdot T \cdot t}{r^2 \cdot S} \right)$$

Jacob's approximation is taken to be satisfactory at 5% from the moment when  $t > 10 \cdot r^2 \cdot S / 4 \cdot T$ . This condition is easy to verify in the context of an aquifer-test. With a well-test, the storage coefficient is not known and Jacob's approximation can reasonably be considered to be fulfilled when the time/drawdown relationship on the semi-log diagnostic graph becomes linear. Note that the invalidation of Jacob's approximation due to too short a pumping time should not be confused with the well-capacity effect.

### 1.3.2 ESTIMATION OF THE HYDRAULIC PARAMETERS

According to Jacob's logarithmic approximation, if  $Q$ ,  $T$  and  $S$  are constant with reference to the initial assumptions, the plot of drawdown versus the logarithm of time forms a straight line (as

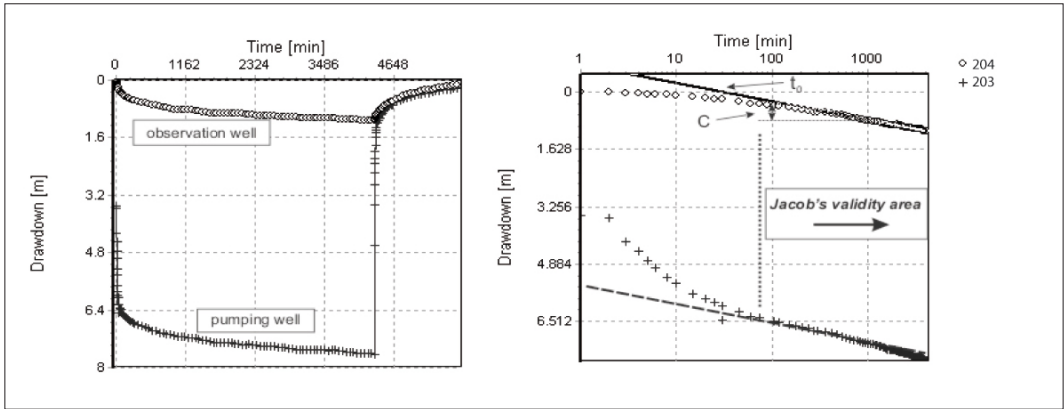


Figure 6.3: Aquifer-test interpretation using Jacob's method.

soon as the duration condition is fulfilled). The slope of this line is:

$$C = \frac{0.183 \cdot Q}{T}$$

$$\Leftrightarrow T = \frac{0.183 \cdot Q}{C}$$

If this line is extended until it intercepts the time axis where  $s=0$ , we obtain a value of  $t$  called  $t_0$ . Substituting this value into Jacob's logarithmic approximation gives:

$$0 = \frac{0.183 \cdot Q}{T} \cdot \log \left( \frac{2.25 \cdot T \cdot t_0}{r^2 \cdot S} \right)$$

$$\rightarrow \frac{2.25 \cdot T \cdot t_0}{r^2 \cdot S} = 1$$

$$\rightarrow S = \frac{2.25 \cdot T \cdot t_0}{r^2}$$

Figure 6.3 illustrates the used of Jacob's method on a borehole drilled in a weathered granitic formation. Well 203 is the pumping well and well 204 is the observation well situated at a distance of 84 m. The test was conducted with a constant discharge of 6 m<sup>3</sup>/h. The slope  $C$  of the Jacob's straight line is calculated from the observation-well data: when plotted on the same graph as the pumping-well data, it confirms the similar development of both drawdowns. Using the graphical value of  $C$  and  $t_0$ , the calculated hydraulic characteristics of the aquifer are  $T=5.8 \cdot 10^{-4}$  m<sup>2</sup>/s and  $S=1.6 \cdot 10^{-4}$ .

The calculation of Jacob's method validity gives  $t > 10 \cdot r^2 \cdot S / 4 \cdot t \rightarrow t > 1.3$  hours, that confirms the validity of the interpretation that considers the data point after 80 minutes.

### 1.3.3 SUPERPOSITION PRINCIPLE

Assuming pumping at flow rate  $Q$  for a period  $t$ , followed by a pause of duration  $t'$ , the superposition of flow principle is such that after pumping stops it is as if pumping were to be continued at flow rate  $Q$  which would lower the level such that:

$$0.183 \cdot Q \quad 2.25 \cdot T \cdot t$$



$$s = \frac{Q}{T} \cdot \log \left( \frac{2.25 \cdot T \cdot t'}{r^2 \cdot S} \right)$$

But at the same time, the well is recharged at flow rate  $Q$  which would raise the levels so that:

$$s' = \frac{0.183 \cdot Q}{T} \cdot \log \left( \frac{2.25 \cdot T \cdot t'}{r^2 \cdot S} \right)$$

**Table 6.II: Drawdown equations.**

Step	Flow	Duration	Equation for theoretical drawdown at end of step
Pumping 1	+ $Q_1$	$t_1$	$s_1 = [(0.183Q_1)/T] \log [(2.25Tt_1)/(r^2S)]$
Recovery 1	- $Q_1$	$t'_1$	$s'_1 = [(0.183Q_1)/T] \log [(2.25Tt_1)/(r^2S)] - [(0.183Q_1)/T] \log [(2.25Tt'_1)/(r^2S)]$ $s'_1 = [(0.183Q_1)/T] \log (t_1/t'_1)$
Pumping 2	+ $Q_2$	$t_2$	$s_2 = [(0.183Q_1)/T] \log (t_1/t'_1) + [(0.183Q_2)/T] \log [(2.25Tt_2)/(r^2S)]$
Recovery 2	- $Q_2$	$t'_2$	$s'_2 = [(0.183Q_1)/T] \log (t_1/t'_1) + [(0.183Q_2)/T] \log (t_2/t'_2)$
Pumping i	+ $Q_i$	$t_i$	$s_i = \sum_{j=1}^{i-1} [(0.183Q_j)/T] \log (t_j/t'_j) + [(0.183Q_i)/T] \log [(2.25Tt_i)/(r^2S)]$

For pumping in steps of  $n$  flow rates, results represented in Table 6.II are obtained, where  $t_i$  is the elapsed time since the beginning of pumping  $Q_i$ , and  $t'$  the elapsed time after pumping  $Q_i$  is stopped. It is assumed that the head losses are negligible.

#### 1.4 Theis's recovery method

The transmissivity of the aquifer can be calculated by interpreting the curve of recovery after pumping has ceased. It provides an important check of the transmissivity calculation with Jacob's method, and allows estimation of transmissivity when no observation wells or piezometers are available. Indeed, with well tests the accuracy of transmissivity estimation while pumping (Jacob's method) is not as good because of the variations in flow rate and because of quadratic head losses in the pumping well (see well test information in Section 2).

The analysis of a recovery test is based on the superposition principle: after the pump has been switched off, the well continues to be pumped at the same discharge rate while an imaginary recharge equal to the discharge is injected into the well. Discharge and recharge cancel each other.

The conditions underlying the method are the same as that for Jacob's method. According to Jacob's approximation and superposition principle, the equation for residual drawdown after pumping stops is written:

$$s_r = \frac{0.183 \cdot Q_i}{T} \cdot \log \left( \frac{t_i}{t'_i} \right)$$

where  $s_r$  is the residual drawdown (m),  $Q_i$  the flow rate at the last pumping  $i$  ( $m^3/h$ ),  $T$  the transmissivity ( $m^2/h$ ),  $t_i$  the elapsed time from the beginning of pumping  $i$  (h), and  $t'_i$  the elapsed time from the end of pumping  $i$  (h).

The experimental pairs ( $s_r, t/t'$ ), plotted on semi-logarithmic paper, are aligned when the Jacob regime is reached. The slope of the fitted straight line is  $C = 0.183 \cdot Q / T$ .

Figure 6.4 illustrates the Theis recovery procedure. The transmissivity obtained is  $3.9 \cdot 10^{-4} m^2/s$  for the observation well (204) and  $4.2 \cdot 10^{-4} m^2/s$  for the pumping well (203). These values are close to

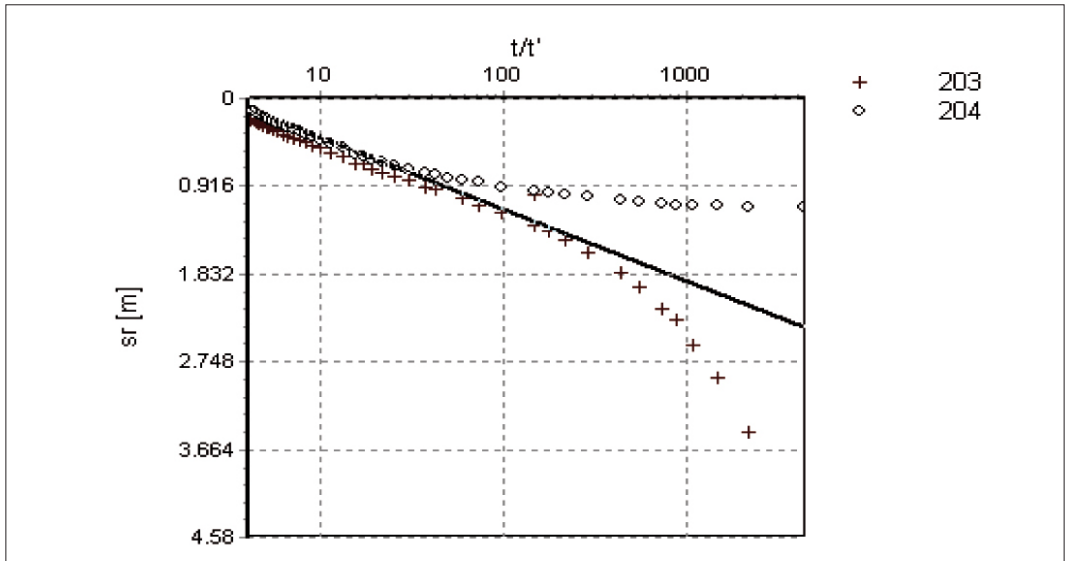


Figure 6.4: Aquifer-test interpretation using Theis's recovery method.

the one obtained with the Jacob method ( $5.8 \cdot 10^{-4} \text{m}^2/\text{s}$ ), and the interpreted transmissivity of the aquifer chosen is the average i.e.  $4.6 \cdot 10^{-4} \text{m}^2/\text{s}$ .

## 2 Well test

The well test is used to determine the conditions of well exploitation:

- operating yield and pumping schedule;
- installation depth of the pump;
- depth of well-borehole connection when a combined well is planned (see Chapter 8B).

Two well-test methods are frequently used. They are based on the same principle: pumping at different flow rates (known as pumping steps) is carried out, and the effect on water level (known as drawdown) is observed.

In the case of pumping in non-connected flow-rate steps, after every pumping step there is an observation time for the rise in water level (known as recovery). This recovery time is at least equal to that of the pumping-step time. It takes an average of 14 hours of field measurements to carry out a test, and the interpretation of field records is easier and more thorough than that of the other method.

For pumping in connected flow-rate steps, no recovery time is allowed. This method is quicker than the non-connected method (an average of 6 hours of field measurements), but for accuracy it requires correction of measured drawdowns after the first step. Its interpretation is therefore a bit more difficult and sometimes less thorough.

### 2.1 Non-connected steps

#### 2.1.1 STANDARD METHOD

A minimum of three successive pumping periods of 2 hours each are carried out at increasing flow rates. Each pumping period is separated by a pause at least as long, in order to allow the initial water level in the well to be approximately recovered (Figure 6.5).

The test includes the following phases:

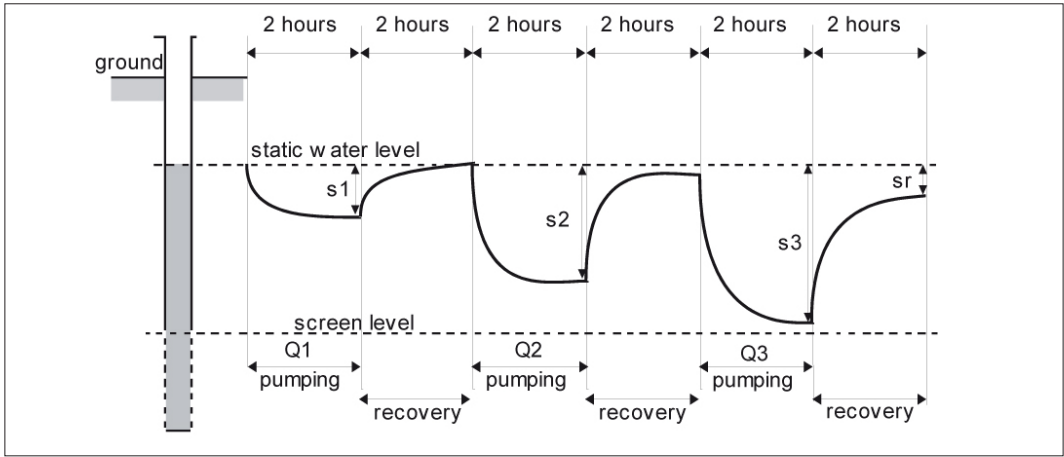
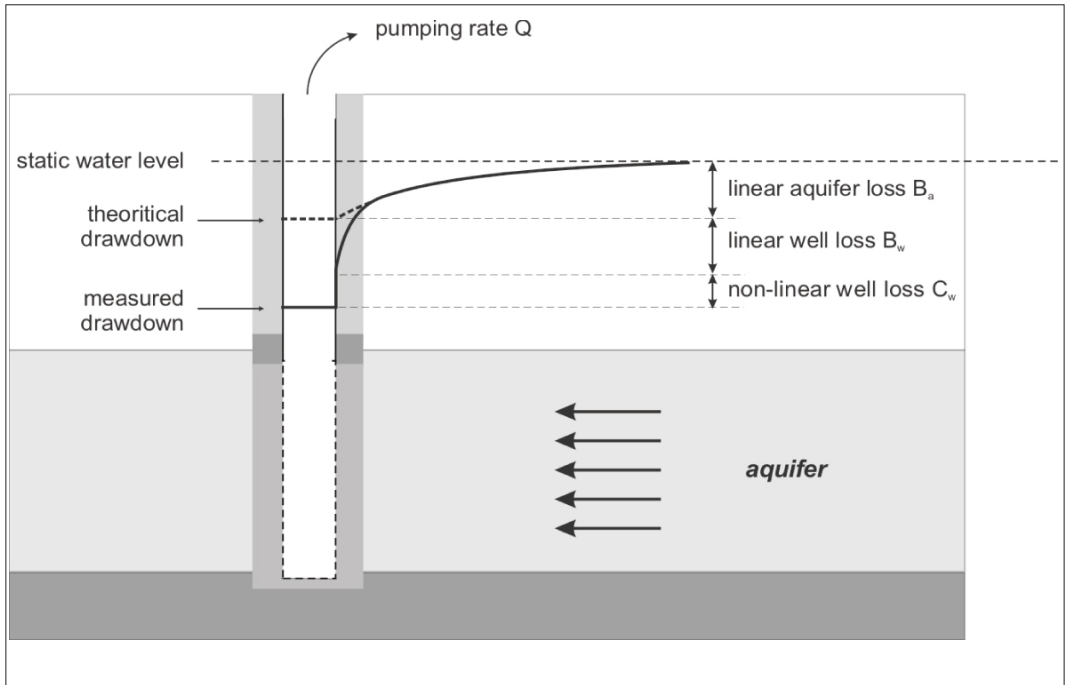


Figure 6.5: Well test with non-connected steps.

0	Rest phase	No work should take place for a period of at least 24 h, so that the level of the water measured before the first pumping step is actually the static level.
1	Pumping step No 1	Flow rate $Q_1$ of the first step is near to the future operational flow rate. In the case of manual pumping, the flow rate is: $0.7 \text{ m}^3/\text{h} < Q_1 < 1.0 \text{ m}^3/\text{h}$ Pumping time is 2 h Drawdown $s_1$ is the drawdown measured at the end of pumping
	Recovery No 1	The observation time for water-level recovery after pumping is 2 h
2	Pumping step No 2	Flow rate $Q_2 = (Q_1 + Q_3)/2$ Pumping time is 2 h $s_2$ is the drawdown measured at the end of pumping (2 h)
	Recovery No 2	The observation time for water-level recovery after pumping is 2 h
3	Pumping step No 3	$Q_3 = Q_{\max} \cdot Q_{\max}$ is the previously-determined maximum flow rate which should not induce the dewatering of the well. In practice $Q_{\max}$ can prove to be difficult to evaluate: an arbitrary value of $Q_3$ is therefore taken as equal to 70% of the value of the maximum flow rate at the time of well development Pumping time is 2 h $s_3$ is the drawdown measured for a pumping time of 2 h
4	Recovery No 3	The observation time for water-level recovery after pumping is at least 2 h, but should last until the water level approaches the initial static water level The difference between the initial water level and that measured after the observation of recovery is called residual drawdown ( $sr$ )

The drawdowns and pumping rates as functions of time are recorded during the whole process. The inter-related flow rate/maximum drawdown pairs  $(Q_1, s_1)$   $(Q_2, s_2)$   $(Q_3, s_3)$  are recorded at the end of each step.



**Figure 6.6: Various head-losses in a pumped well.**

### 2.1.2 DATA VALIDATION AND INTERPRETATION

Before interpreting the field data, the records should be verified as presented in Section 1: any external changes, other than the test pumping, should be identified and any obviously wrong records should be removed or corrected.

There are several methods for analysing the data that may be found in the cited references. Two simple and easy-to-use methods are presented in this chapter: the Jacob's drawdown method is used to calculate the head-losses, and the Theis's recovery method is used to estimate the local transmissivity of the aquifer.

#### *The Jacob's drawdown equation*

For the drawdown in a pumped well, the Jacob's equation is (Kruseman & de Ridder, 2000):

$$s = (B_a + B_w) \cdot Q + C_w \cdot Q^p$$

where  $s$  is the measured drawdown,  $Q$  is the pumping yield,  $B_a$  is the linear aquifer head-loss coefficient,  $B_w$  is the linear well head-loss coefficient,  $C_w$  is the non-linear well head-loss coefficient and  $p$  can vary between value of 1.5 to 3.5.

Jacob's equation tells us that drawdown measured in a pumped well consists of two components (Figure 6.6): the aquifer head-losses and the well head-losses. Aquifer head-losses occur in an aquifer when the flow is laminar. They are time-dependent and they vary linearly with the pumping rate. They are quantified with  $B_a$  coefficient. Well losses are divided into linear and non-linear head-losses. The linear head-losses are caused by damage to the aquifer during drilling and completion of the well ( $B_w$  coefficient); the non-linear head-losses occur mainly in the gravel pack and the screen where the flow is turbulent ( $C_w$  coefficient).

In practice, it is not possible to differentiate  $B_a$  and  $B_w$  coefficients and Jacob's equation is simplified as  $s = B \cdot Q + C \cdot Q^2$ . The interpretation method makes possible to evaluate the linear head-

losses coefficient B and the quadratic head-losses coefficient C. Knowing B and C, it is possible to predict the drawdown for any discharge Q at a certain time t (B is time dependant). From the relationship between s and Q, it is also possible to determine an optimum operating yield for the well. Finally, the relative value of C is used to evaluate the well efficiency.

This method is only theoretically valid when the following conditions apply:

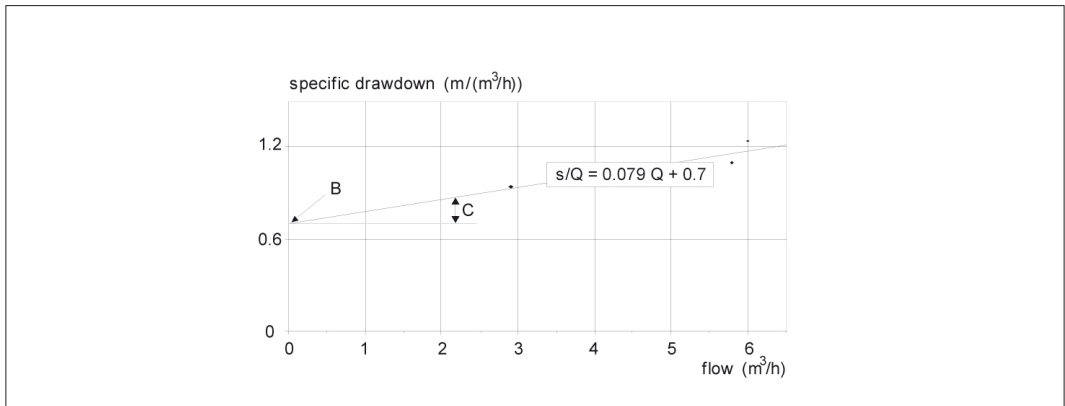
- the aquifer is confined, unconfined or leaky;
- the aquifer has an infinite area extent;
- the aquifer is homogeneous, isotropic and of uniform thickness over the area influenced by the test;
- the piezometric surface is horizontal over the area influenced by the test, before the beginning of the test;
- the well penetrates the entire thickness of the aquifer so that the flow is horizontal in the aquifer;
- the non-linear head-losses vary according to  $C \cdot Q^2$  ( $p=2$ ).

These ideal conditions are not always encountered in reality: it is thus essential to be vigilant concerning the interpretation of results, and to use common sense and accuracy in taking measurements, in order to remain within an acceptable range of approximation.

The interpretation can be carried out manually (using graph paper), with support software such as Excel (prepared worksheets with formulas), or using specific interpretation software such as WHI AquiferTest Pro (<http://www.flowpath.com>).

*Well-efficiency estimation: head-loss calculation*

According to Jacob's equation, a plot  $s_i/Q_i = f(Q_i)$  will yield a straight line of slope C and ordi-



**Figure 6.7: Calculation of head losses.**

**Well test: borehole F1 – Estimation of head-losses using Jacob's method. Linear head-losses: B = 0.7 m/(m³/h). Quadratic head-losses: C = 7.9 10<sup>-2</sup> m/(m³/h)<sup>2</sup>.**

nate at the origin B ( $s = B \cdot Q + C \cdot Q^2 \Leftrightarrow s/Q = B + C \cdot Q$ , Figure 6.7). Values of B and C provide the equation of the borehole for all flow rates for which the pumping time is that of the test. Note that this procedure is completely valid when the steady state is reached at the end of each step. In practice, it is important to maintain pumping until the drawdowns vary little with time (quasi-steady state).

Another parameter, called J, is used to estimate the borehole quality (Forkasiewicz 1972). J is a coefficient that represents the ratio between linear and quadratic head-losses as  $J = \Delta Q/s / Q/s$ .

B, C, and J cannot be interpreted on their own, but they can be compared between several actual wells. It is useful to estimate the quality of a well in a rehabilitation programme or when planning the installation of a submersible pump. According to De Marsily (1986) and Forkasiewicz (1972) a first approximation of well efficiency can be made from the values in Table 6.III.

**Table 6.III: Order of magnitude of head-losses.**  
**C is expressed in  $m/(m^3/h)^2$ .**

C	$C < 1.9 \cdot 10^{-2}$	Good well, highly developed
	$1.9 \cdot 10^{-2} < C < 3.7 \cdot 10^{-2}$	Significant head-losses
	$3.7 \cdot 10^{-2} < C < 1.5$	Clogged or deteriorated well
	$C > 1.5$	Well that cannot be rehabilitated
J	$J < 10\%$	Quadratic head-losses negligible compared to linear head-losses
	$J > 10\%$	Quadratic head-losses significant compared to linear head-losses

*Evaluation of maximum pumping rate: the well curve*

At the end of every step, the pairs  $(s_1, Q_1)$ ,  $(s_2, Q_2)$  and  $(s_3, Q_3)$  are recorded. By plotting these values in an linear diagram, with  $s$  as ordinate and  $Q$  as abscissa, the link between the pumped flow rates and the drawdown created is illustrated (Figure 6.8). From the head-loss equation,  $s = BQ + CQ^2$ , it is possible to plot on the same graph the straight line  $s = BQ$ , in order to visualise the linear and quadratic head-losses of the drawdown.

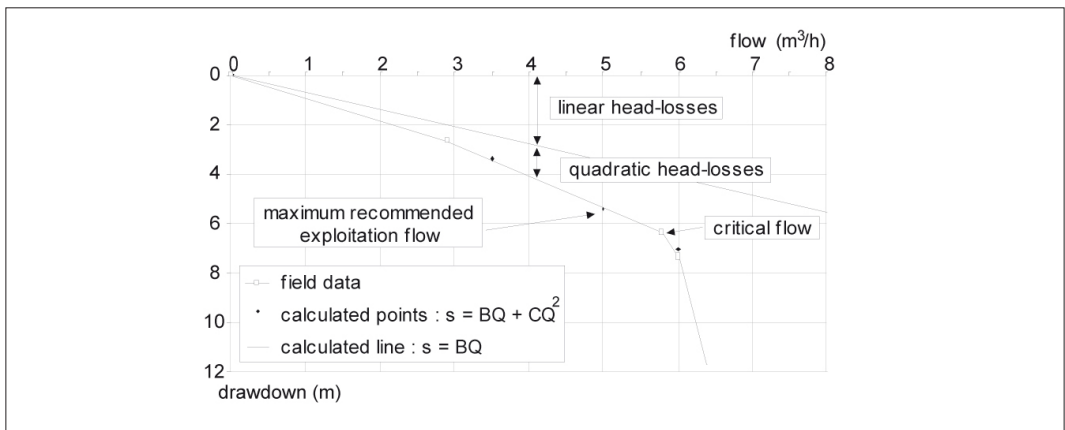
A significant increase in quadratic head-losses creates a point of inflection on the curve, which allows the critical flow rate to be determined. Such a point of inflection is due to an over-pumping that creates important turbulent flow and heavy non-linear head-losses, but it can also be caused by

$$Q = \frac{\sqrt{B^2 + 4 \cdot C \cdot s} - B}{2 \cdot C}$$

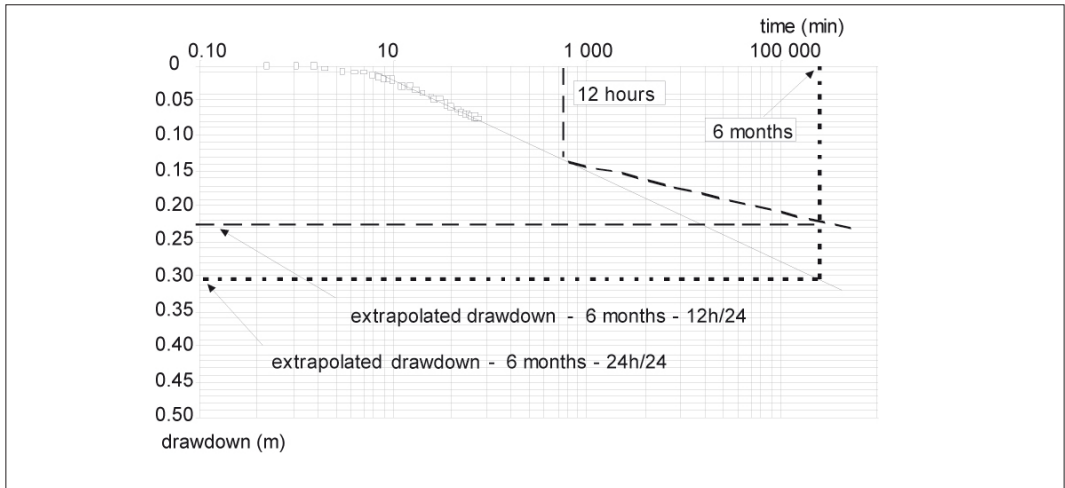
the dewatering of a particularly productive horizon. The maximum flow rate is set slightly lower than the critical flow rate. If there is no clear break in the slope of the well curve, the maximum flow rate is set according to the possible maximum drawdown, that is generally 1 m above the pump screens. Jacob's equation  $s = B \cdot Q + C \cdot Q^2$  has a positive real solution

By inserting the maximum permissible drawdown in place of  $s$ , the maximum flow rate is obtained.

Note that if values  $(s_i, Q_i)$  are aligned in a slightly concave curve, it may be that the measurements had not been taken properly, or that well development occurred during pumping (gravel-pack clearing, improvement of water circulation in the immediate neighbourhood of the well). In this case, the test must be repeated.



**Figure 6.8: Well curve  $s = f(Q)$  of borehole F1.**



**Figure 6.9: Extrapolation of drawdown as a function of time.**

*Evaluation of possible future drawdown: link between drawdown, yield and time*

To estimate drawdown induced by pumped flow-rates differing from those of the tests, it is possible to use the head-loss equation  $s = B \cdot Q + C \cdot Q^2$ . Drawdowns estimated in this way are only valid for pumping times equivalent to the durations of the test steps.

In a well test, it is not possible to make a reliable estimate of drawdown induced by pumping times longer than those of the tests. Indeed, the effects of several hours' pumping are only appreciable in a restricted part of the aquifer surrounding the pumping well (see Section 3). Nevertheless, various solutions have been proposed and have been used on a large scale in Africa, to optimise information from well tests. Some of these results are presented here because they seem to have been consistent in the field. However, they must be used while being aware of their limitations: the extrapolation of data to predict operations over 6 months from a well test of some hours is not really reliable.

Drawdowns measured during the test (ordinate, linear) are plotted against pumping time (abscissa, logarithmic) on a semi-logarithmic graph. The curve  $s = f(t)$  must be a straight line after some time (see the section on Jacob's method). It is possible to extend this straight line to estimate the drawdown induced by the same flow rate but for a longer pumping time (Figure 6.9).

If the pumping period is  $n$  hours per day, the drawdown after 6 months can be estimated as follows:

- from test data, extrapolate drawdown induced by  $n$  hours of pumping by extending the straight line  $s = f(t)$  to  $n$  hours;
- extend this straight line beyond  $n$  hours (up to 6 months for example) by correcting its slope by the ratio  $n/24$ .

The first straight line of Figure 6.4 is an extrapolation of drawdown for a pumping time of 6 months, 24 h per day. The second one is an example of drawdown extrapolation for pumping 12 h per day for 6 months.

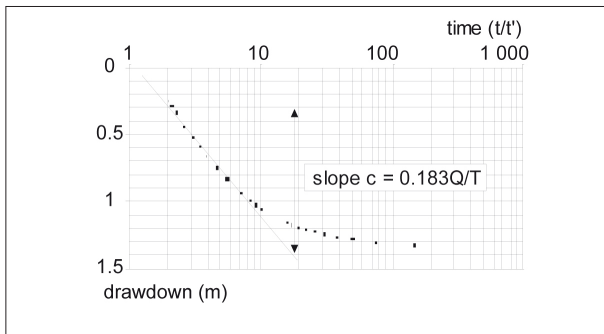
Proceeding in this way for the various steps, new pairs ( $s_i$  extrapolated,  $Q_i$ ) are obtained, enabling a new well curve of  $s_{\text{extrapolated}} = f(Q)$  to be constructed. A theoretical operational flow rate can then be set on the basis of permissible maximum drawdown.

*Depth of installation of the pump: prediction of dynamic level*

The depth of installation of the pump inlet screen is a function of the predicted dynamic level. This level is given by the drawdown induced by the rate of abstraction, increased by annual piezometric variations. For accuracy, a correction taking into account year-to-year variations of static level should also be applied.

**Table 6.IV: Fluctuations (m) in static water level, raised in formations of weathered bedrock in various countries of the Sudan-Sahel zone.**

Static level	Foreseeable static level fluctuations									
	Sept	Oct	Nov	Dec	Jan	Feb	Mar	Apr	May	Jun
5 m	6	5.40	4.80	4.20	3.60	3	2.40	1.80	1.20	0.60
10 m	4	3.60	3.20	2.80	2.40	2	1.60	1.20	0.80	0.40
15 m	2.50	2.25	2	1.75	1.50	1.25	1	0.75	0.50	0.26
20 m	1.50	1.35	1.20	1.05	0.90	0.75	0.60	0.45	0.30	0.15
25 m	1	0.90	0.80	0.70	0.60	0.50	0.40	0.30	0.20	0.10



**Figure 6.10: Recovery curve, borehole F4 –  $s = f(t/t')$ .**

The drawdown must be estimated for an operational flow rate of a duration equivalent to that of the dry period (4 to 8 months, depending on context) and for a length of daily pumping to be established (4 to 20 h). It must be increased by seasonal variations in piezometric level (Table 6.IV). The pump inlet screen is then generally installed at 2 or 3 m below the dynamic level so established.

For example, in a pumping test on a borehole intended to be equipped with a handpump, interpretation of the test predicts an drawdown of 5.50 m after 8 months of pumping at 1 m<sup>3</sup>/h for 8 h per day. The static level measured before the test of February 15 is 17.5 m. According to Table 6.IV, the foreseeable decrease in static level before the next rains (June) is 1 m. The proposed installation of the pump is therefore : 17.5 + 1 + 5.5 + 3 = 27 m

Note that this procedure is also used to estimate the depth of a well when a combined well is under construction (see Chapter 8D). At the time of sinking the well after drilling the borehole, the minimum depth of the well will be about 1 or 2 m lower than the foreseeable dynamic level.

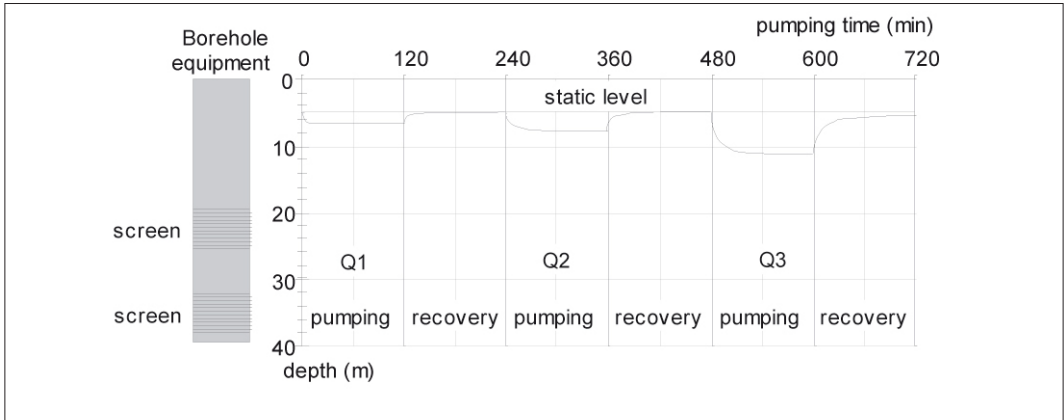
*Local transmissivity estimation: recovery analysis*

A well test does not provide a representative value of the transmissivity of an aquifer. Pumping times are not long enough to concern a sufficient volume of aquifer. The transmissivity calculated from a well test is therefore a local feature, but it is still of interest in that it gives a comparison between wells.

The most reliable evaluation of transmissivity comes from the interpretation of the recovery curve (rise in water level after the final pumping step). The common interpretation method, called Theis's recovery method (Kruseman & de Ridder, 2000) is presented Section 1. The procedure is to plot the experimental pairs (t/t', s) on semi-logarithmic paper, and to fit a straight line through them considering mainly the late time. The transmissivity is calculated from the slope of this straight line that is  $C = 0.183 \cdot Q / T$  where Q is the flow rate of the last pumping i (m<sup>3</sup>/h), T is the transmissivity (m<sup>2</sup>/h), with t and t' the elapsed times since the beginning and end of pumping i respectively (h). An example of a recovery curve is given in Figure 6.10.

**2.1.3 EXAMPLES**





**Figure 6.11: Water level as a function of time.**

These examples concern Sierra Leonean refugee camps in the Forecaria region of Guinea Conakry. The 1998 ACF borehole programme was implemented to supply the camps with drinking water. The geological context is weathered and fractured crystalline rock (mesocrates, diorites or gabbros).

The objectives of well tests were to decide the installation depth of foot pumps (Vergnet HPV60 type) and to check if boreholes were capable of being equipped with small pumping stations (to provide a rapid increase in water abstraction in case of a new influx of refugees).

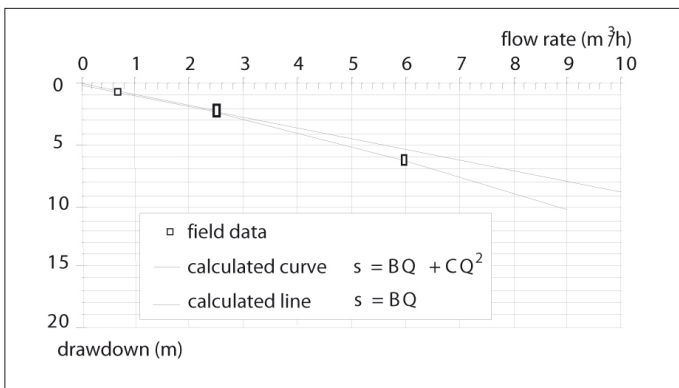
*High-productivity well: borehole No.1 (Kaleah I)*

The main results of this test are shown in Figures 6.11 and 6.12 and Tables V and VI.

This borehole can reliably be equipped with a Vergnet HPV 60 pump. The pump inlet screen is fixed at 12 m deep (taking account of static level fluctuations and allowing a 3-m safety factor).

This borehole can also be selected for the installation of a small pumping station if the number of refugees were to increase over the next months: indeed a flow rate of 6 m<sup>3</sup>/h seems to be possible. The final level was achieved at the maximum capacity of the submersible pump used. However, a flow rate greater than 6 m<sup>3</sup>/h could be considered if the drawdown does not deviate from the calculated curve  $s = f(Q)$  (so as not to exceed the critical flow rate that could not be observed yet) and drawdown does not go below the top of the screens (in order to avoid dewatering of the productive zone).

The top of the borehole screens lies at 19.5 m and the deepest static water level is estimated as 6.5 m; the foreseeable maximum drawdown is 13 m. Taking a safety margin of 3 m, a maximum



**Figure 6.12: Curve of flow rate vs drawdown [ $s = f(Q)$ ].**

**Table 6.V: Test conditions.**

Date	Water	Turbidity	T	pH	EC	Maximum exploitation flow (m <sup>3</sup> /h)
22/01/1998	clear no sand (stain test < 0.5 cm)	< 5 NTU	27.5°C	7.8	205-220 µS/cm	6-8.8

**Table 6.VI: Test results.**

Flow/step (m <sup>3</sup> /h)	Pumping time (h)	Drawdown (m)		Specific capacity (m <sup>3</sup> /h)/m	Value of quadratic head-losses m/(m <sup>3</sup> /h) <sup>2</sup>
		max at end of step	residual after 2 h		
0.7	2	0.65	0.02	1.077	6 · 10 <sup>-3</sup>
2.5	2	2.33	0.05	1.073	
6	2	6.29	0.09	0.954	

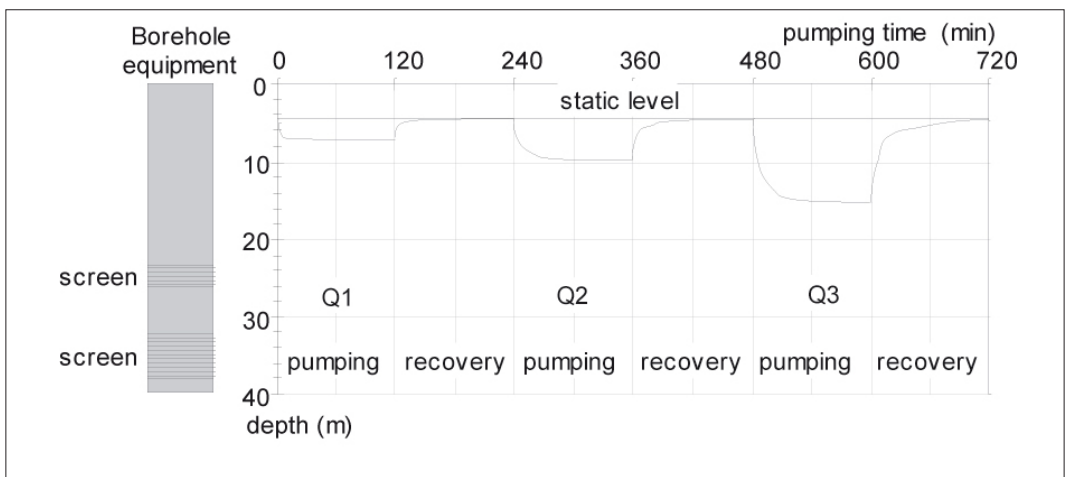
drawdown of 10 m can be estimated. Referring to the curve  $s = f(Q)$ , this drawdown corresponds to a flow rate of about 8.8 m<sup>3</sup>/h. These values must be verified at the time of installation of any possible pumping station, and a regulating valve may have to be used to adjust the flow rate to conform with observations on measured drawdown values.

*Low-productivity well: borehole No. 2 (Kaleah I)*

The results of this test are shown in Figures 6.13 and 6.14 and Tables 6.VII and 6.VIII.

This borehole is productive enough to be equipped with a Vergnet HPV 60 pump. The pump inlet screen is fixed at 15 m deep.

In spite of a flow rate measured at 5 m<sup>3</sup>/h at the time of the borehole drilling, it is not advisable to install a small pumping station at this borehole because the head-losses are relatively significant compared to that of the borehole No.1. The stabilisation of drawdown was not fully reached

**Figure 6.13: Water levels as a function of time.**

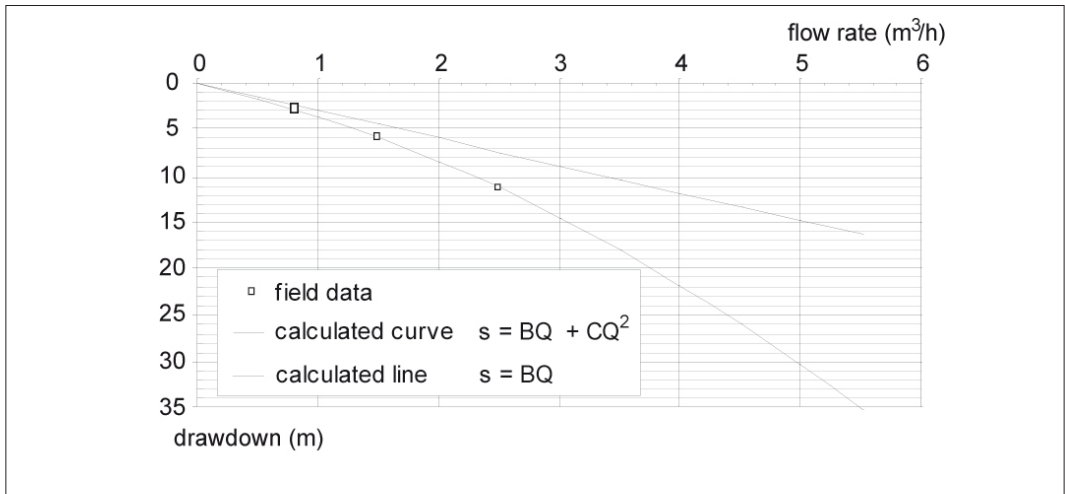


Figure 6.14: Curve of flow rate against drawdown [ $s = f(Q)$ ].

Table 6.VII: Test conditions.

No variation in these values during the test.

Date	Water	Turbidity	T	pH	EC
22/01/1998	clear no sand (stain test < 0.5 cm)	< 5 NTU	28°C	7.8	205-220 $\mu\text{S/cm}$

Table 6.VIII: Test results.

Flow/step (m³/h)	Pumping time (h)	Drawdown (m)		Specific capacity (m³/h)/m	Value of quadratic head-losses $\text{m}/(\text{m}^3/\text{h})^2$
		max at end of step	residual after 2 h		
0.8	2	2.79	0	0.287	$2.2 \cdot 10^{-2}$
1.5	2	5.81	0.09	0.258	
2.5	2	11.34	0.09	0.220	

at the last step, and exploitation flow rates greater than 3.6 m³/h would induce drawdown lower than screen level (top of screens = 23.1 m, static level = 4.4 m, permissible maximum drawdown = 18.7 m,  $Q = 3.6 \text{ m}^3/\text{h}$  if critical flow rate is not reached). Thus the maximum flow rate is estimated at 3 m³/h.

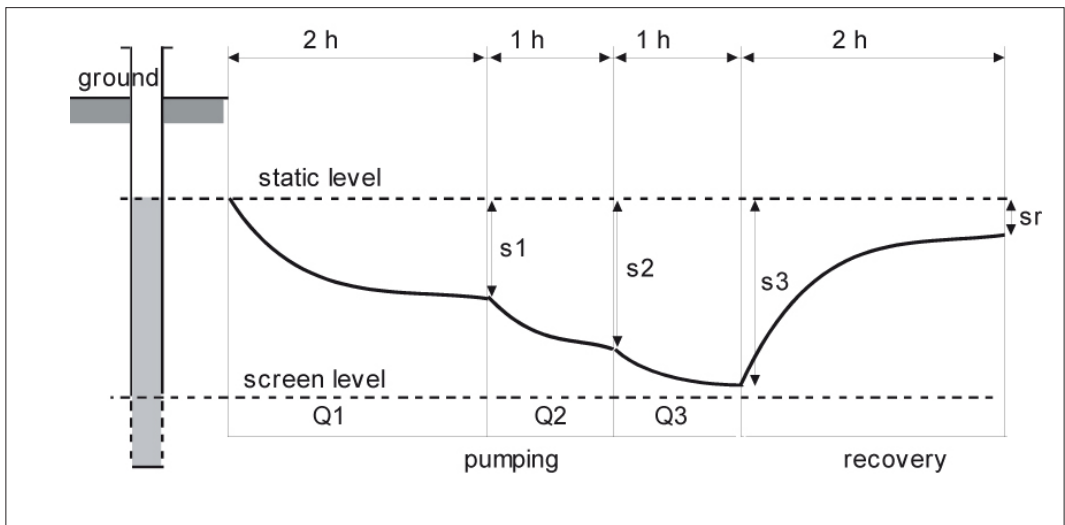
## 2.2 Connected steps

Pumping steps are carried out without recovery time in between. This results in the measured

drawdown being affected by all the previous pumping series, and not only by the last pumping step. To allow strict interpretation, the measured drawdowns need to be corrected so that they reflect only the current pumping step. There are two main methods to conduct this correction: the mathematical calculation of corrected drawdown and the graphical analysis of drawdown.

**Table 6.IX: Test phases.**

0	Rest phase	No work should take place for a period of at least 24 h, so that the level measured before the first pumping is actually the static level
1.	Pumping step No 1	Flow rate $Q_1$ of the first step is near to the future operational flow rate In the case of manual pumping, the flow rate is $0.7 \text{ m}^3/\text{h} < Q_1 < 1.0 \text{ m}^3/\text{h}$ Pumping time is 2 h Drawdown $s_1$ is the drawdown measured at the end of pumping
2	Pumping step No 2	Flow rate $Q_2 = (Q_1 + Q_3)/2$ Pumping time is 1 h $s_2$ is the drawdown measured at the end of pumping (2 + 1 = 3 h)
3	Pumping step No 3	$Q_3 = Q_{\text{max}}$ . $Q_{\text{max}}$ is the previously-determined maximum flow rate which should produce the maximum drawdown In practice $Q_{\text{max}}$ can prove to be difficult to evaluate: an arbitrary value of $Q_3$ is therefore taken as equal to 70% of the value of the maximum flow rate at the time of well development Pumping time is 1 h $s_3$ is the drawdown measured for a pumping time of (2 + 1 + 1 = 4 h)
4	Recovery	The observation time for water-level recovery after pumping is at least 2 h, but should last until the water level reaches a level of about the initial static water level The difference between the initial water level and that measured after the observation of recovery is called residual drawdown ( $s_r$ )



**Figure 6.15: Well test in connected steps.**

### 2.2.1 SIMPLIFIED METHOD

Three connected pumping steps are carried out at increasing flow rates, and the recovery in water level in the well is observed until a level close to the static level before the test is reached (Figure 6.15). The test phases are given in Table 6.IX:

### 2.2.2 CALCULATION OF CORRECTED DRAWDOWNS

To calculate the drawdown corresponding to the one that would have been created by the current step alone, Jacob's method is used according to the superposition principle (see Section 1.3.3). Considering a non-connected well test, if recovery times are at least as long as pumping times, and the progression of flow rates is meaningful, terms under the  $\Sigma$  sign of drawdown equation given in Table 6.II rapidly become negligible compared to the isolated term. Equations of drawdown are then simplified  $S_i = [(0.183Q_i)/T] \log[(2.25Tt_i)/(r^2S)]$  where  $i$  is the step number. The theoretical drawdowns at the end of each step of a non-connected well test are therefore induced only by the last pumping. A set of pairs ( $s_i/Q_i$ ) is then obtained, measured directly on site and comparable with one another.

When pumping steps are connected, it is no longer possible to disregard the terms under  $\Sigma$ . Drawdowns obtained at the end of steps are therefore induced by the total previous steps, and they

$$s_2 = \frac{0.183 \cdot Q_1}{T} \cdot \log \left( t_2 \frac{2.25 \cdot T}{r^2 \cdot S} \right) - \frac{0.183 \cdot Q_1}{T} \cdot \log \left( (t_2 - t_1) \frac{2.25 \cdot T}{r^2 \cdot S} \right) + \frac{0.183 \cdot Q_2}{T} \cdot \log \left( (t_2 - t_1) \frac{2.25 \cdot T}{r^2 \cdot S} \right) + J_2$$

$$\rightarrow s_2 = \frac{0.183 \cdot Q_1}{T} \cdot \log \left( \frac{2.25 \cdot T}{r^2 \cdot S} \right) + \frac{0.183 \cdot (Q_2 - Q_1)}{T} \cdot \log \left( (t_2 - t_1) \frac{2.25 \cdot T}{r^2 \cdot S} \right) + J_2$$

$$s_3 = \frac{0.183 \cdot Q_1}{T} \cdot \log \left( t_3 \frac{2.25 \cdot T}{r^2 \cdot S} \right) + \frac{0.183 \cdot (Q_2 - Q_1)}{T} \log \left( (t_3 - t_1) \frac{2.25 \cdot T}{r^2 \cdot S} \right) + \frac{0.183 \cdot (Q_3 - Q_2)}{T} \cdot \log \left( (t_3 - t_2) \frac{2.25 \cdot T}{r^2 \cdot S} \right) + J_3$$

need to be corrected to be compared.

For a well test of three connected steps, the measured drawdowns are:

$$s_1 = \frac{0.183 \cdot Q_1}{T} \cdot \log \left( t_1 \frac{2.25 \cdot T}{r^2 \cdot S} \right) + J_1$$

By definition the corrected drawdowns are:

$$s_{1-c} = \frac{0.183 \cdot Q_1}{T} \cdot \log \left( t_1 \frac{2.25 \cdot T}{r^2 \cdot S} \right) + J_1$$

$$s_{2-c} = \frac{0.183 \cdot Q_2}{T} \cdot \log \left( t_2 \frac{2.25 \cdot T}{r^2 \cdot S} \right) + J_2$$

$$s_{3-c} = \frac{0.183 \cdot Q_3}{T} \cdot \log \left( t_3 \frac{2.25 \cdot T}{r^2 \cdot S} \right) + J_3$$

By combining the two systems of equation, we obtain:

$$s_{1-c} = s_1$$

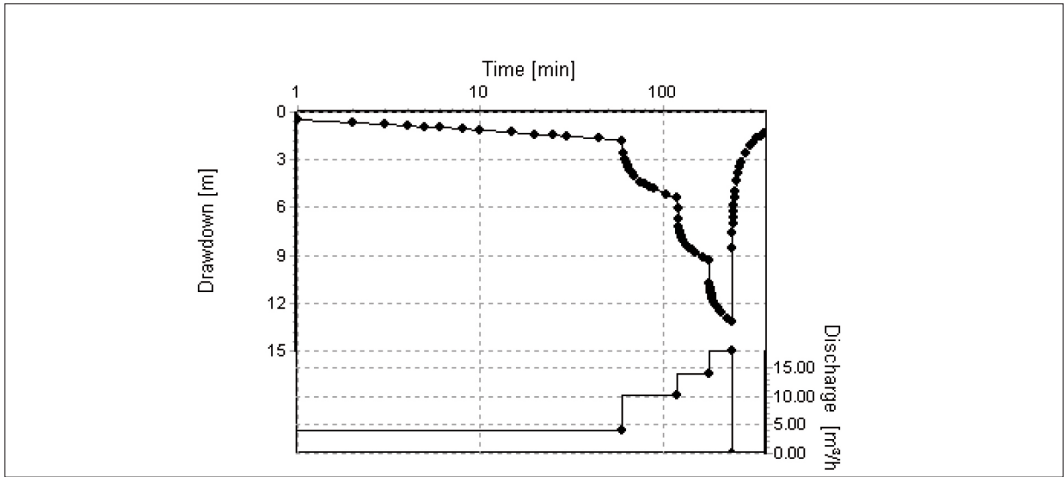


Figure 6.16: Four connected pumping steps, borehole 204.

$$s_{2-c} = s_2 + \frac{0.18}{T} \cdot \left( Q_2 \cdot \log \frac{t_1}{t_2 - t_1} - Q_1 \cdot \log \frac{t_2}{t_2 - t_1} \right)$$

$$s_{3-c} = s_3 + \frac{0.183}{T} \cdot \left( Q_3 \cdot \log \frac{t_1}{t_3 - t_2} - Q_2 \cdot \log \frac{t_3 - t_1}{t_3 - t_2} - Q_1 \cdot \log \frac{t_3}{t_3 - t_1} \right)$$

Whatever the test protocol, it is possible to correct the measured drawdowns using the same calculation. For example, the corrected drawdowns of the simplified method of 2 hours for the first step, 1 hour for the second step and 1 hour for the last step:

$$s_{1-c} = s_1$$

$$s_{2-c} = s_2 + \frac{0.183}{T} \cdot (0.3 \cdot Q_2 - 0.48 \cdot Q_1)$$

$$s_{3-c} = s_3 + \frac{0.183}{T} \cdot (0.3 \cdot Q_3 - Q_2 - Q_1)$$

T can be determined using Theis's recovery method (Section 1) or its modified form given in the following section.

### 2.2.3 GRAPHICAL ESTIMATION OF CORRECTED DRAWDOWNS

A graphical analysis can also be conducted to estimate the corrected drawdowns. This method needs careful data processing to be accurate.

Figure 6.16 presents a test conducted in borehole drilled in a granitic bedrock formation. Four connected steps have been carried out: the last one was stopped because the dynamic water level reached the pump inlet level.

The graphical analysis consists of estimating the drawdown of each particular step using the slope of the previous drawdown development. Figure 6.17 shows the graphical estimation of the cor-

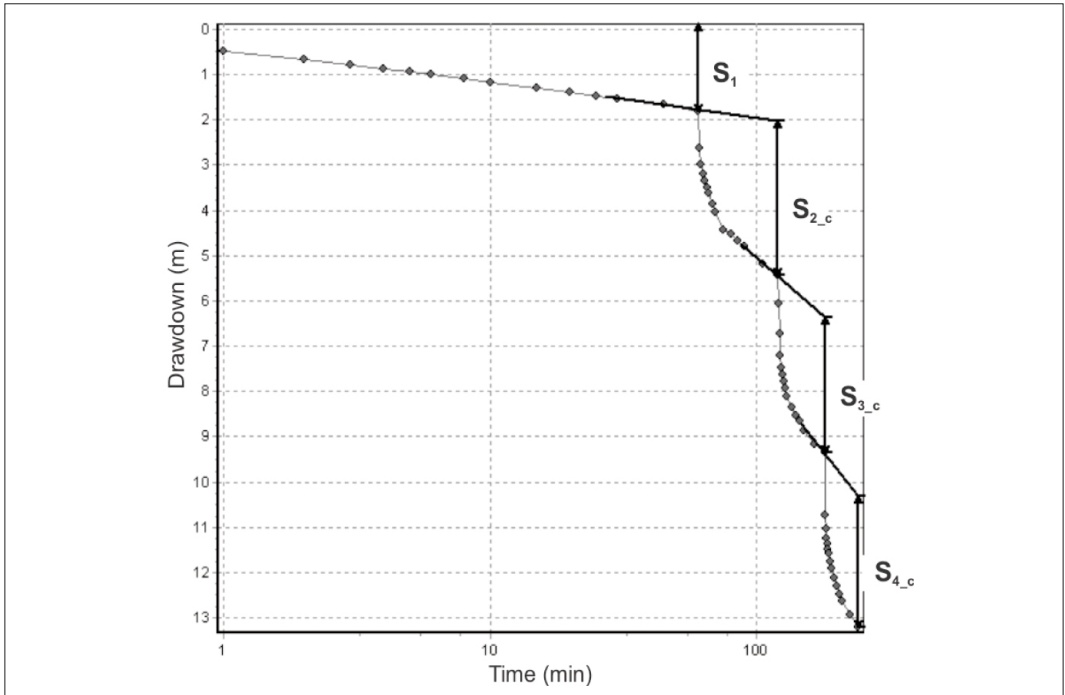


Figure 6.17: Graphical estimation of the corrected drawdown  $s_{i_c}$ , borehole 204.

rected drawdown for the borehole test presented Figure 6.16. The slope has to be chosen carefully because it obviously has a great influence on the drawdown estimation.

#### 2.2.4 DATA VALIDATION AND INTERPRETATION

Data validation and interpretation are carried out in a similar manner to that for the non-connected flow-rate tests, but using the corrected drawdowns. However, some differences exist

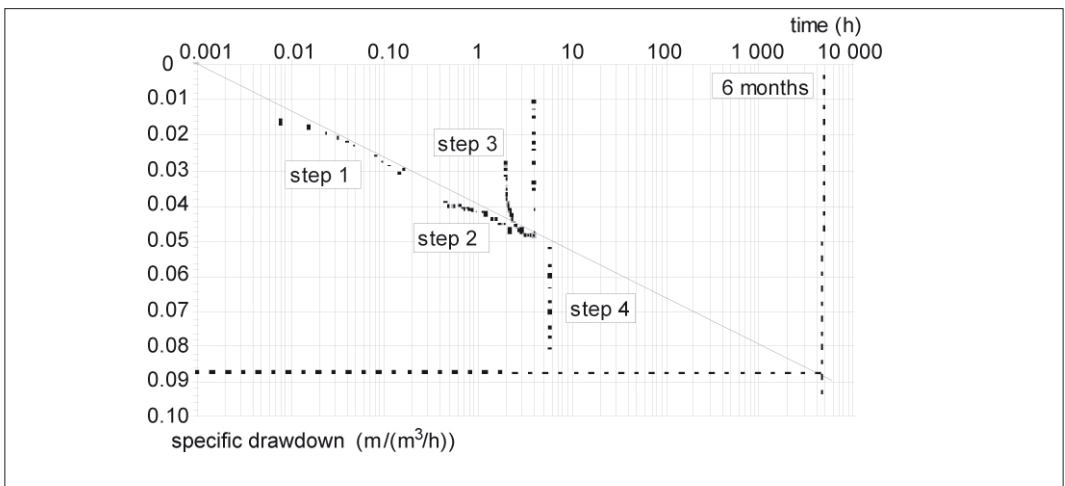
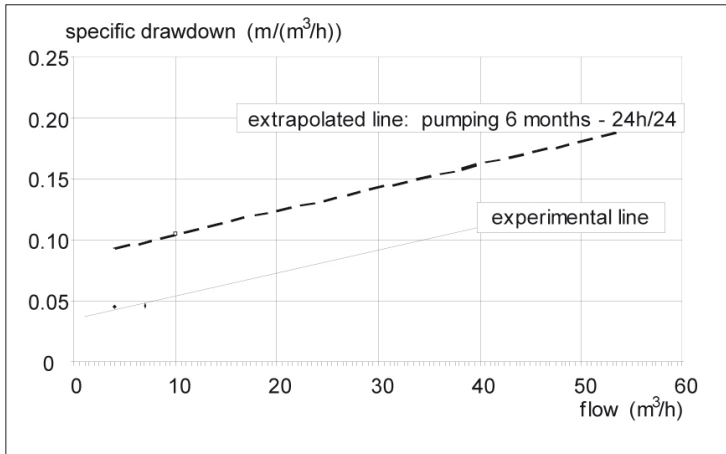


Figure 6.18: Extrapolation of specific drawdown, well P1.



**Figure 6.19: Extrapolation of drawdown, well P1.**

concerning the dynamic level prediction and the local transmissivity estimation.

#### *Prediction of dynamic level*

Recommendations for the extrapolation of data at the time of the interpretation of non-connected well tests also need to be taken into account. It is right, therefore, to be sceptical and to be critical of these somewhat daring extrapolations.

To estimate drawdown induced by a pumping time longer than that of tests, a semi-logarithmic graph of specific drawdown  $s_i/Q_i$  (ordinate, linear) of the set of steps against time (abscissa, logarithmic) is used. The theory is that these points should have a same asymptote that can be represented with a well-fitted straight line (Figure 6.18). This straight line can be extended for longer pumping times than those of the tests. A new value  $s/Q$  corresponding to a new pumping time is then obtained. Plotting this value in the graph  $s/Q = f(Q)$  and drawing a straight line parallel to that obtained in the test gives a new value of  $B$ . It is then possible to define the equation of the well ( $s = BQ + CQ^2$ ) for a new pumping time (Figure 6.19).

#### *Estimation of local transmissivity*

For pumping periods in non-connected steps, it is recommended that local transmissivity is calculated from a survey of the recovery curve.

It is possible to draw this curve of under the form  $(s_3-s) / Q_3 = f(t')$  where  $t'$  is time elapsed since the end of pumping, on the same diagram as that for connected steps  $s / Q = f(Q)$ . The two straight lines (pumping and recovery) must have the same slope  $C$ , such that  $T = 0.183 \cdot Q / C$ .

## 3 Pumping-test procedure

### 3.1 Design of test

Before the test is carried out, it is necessary to collect information on the local geology, the well lithology, the aquifer type and the well (diameter, depth, position of screens, estimated flow rate at the time of development and corresponding drawdown).

This information enables the preparation of the programme of the pumping test and the definition of maximum permissible drawdown, pumped flow rates, number and duration of each pumping step for a well test, number and position of piezometers and pumping duration for an aquifer test.

#### 3.1.1 MAXIMUM DRAWDOWN AND PUMPING RATE



**Table 6.X: Estimated number and duration of steps according to the maximum pumping yield.**

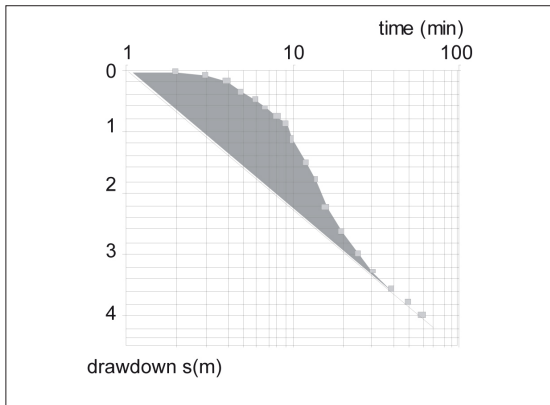
Maximum yield expected (from borehole development or nearby well)	Minimum number of steps	Expected duration of steps
$Q < 2 \text{ m}^3/\text{h}$	1	4 hours
$2 \text{ m}^3/\text{h} < Q < 3 \text{ m}^3/\text{h}$	2	2 + 2 hours
$Q > 3 \text{ m}^3/\text{h}$	3 and more	1.5 + 1.5 + 1.5 hours +...

Indications obtained at the time of the development of the borehole determine the maximum flow rate (that is the last step of a well test). This must equal the maximum permissible drawdown, so that the thickness of the saturated zone should remain constant all over the test duration if the aquifer is confined, and the final drawdown is less than 60% of the saturated thickness if the aquifer is unconfined.

### 3.1.2 WELL TEST: NUMBER AND DURATION OF STEPS

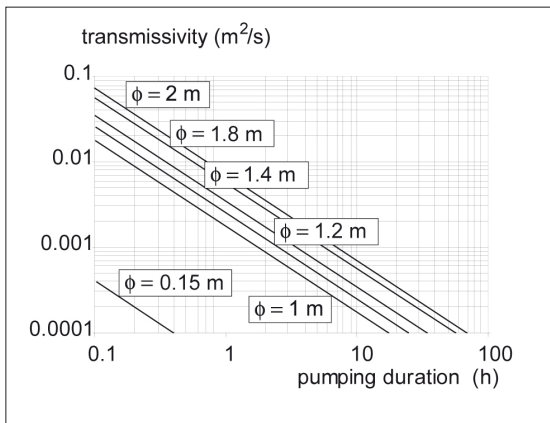
The maximum permissible flow rate allows the number of steps to be estimated according to Table 6.X. It also influences the step duration, which depends on the well and aquifer characteristics.

The duration of steps depends on well behaviour during pumping: it is essential that drawdown



**Figure 6.20: Capacity effect (drawdown delay).**

The effect is represented in grey; pumping time must be greater than 60 mins.



**Figure 6.21: Design chart for evaluating pumping time at which the capacity effect is theoretically negligible.**

The pumping time must be at least ten times greater than the capacity-effect delay.

at the end of a non-connected well test is nearly stabilised. If the water level continues to fall significantly, it is preferable to prolong the pumping duration. For a connected well test, this condition is less important because the drawdowns will be corrected for interpretation. Also, if the aquifer tested has very low transmissivity and the well has a large diameter, the capacity effect can be significant (Figure 6.20) and the duration of pumping steps should be extended as  $t \geq 25 \cdot r^2 / T$  where  $r$  is the well radius and  $T$  the transmissivity (Figure 6.21, University of Avignon, 1990).

The number of steps needs also to be adjustable. On one hand, if the flow rate of the well is lower than 2 or 3 m<sup>3</sup>/h, it is difficult to set three steps with increasing flow rates. Two steps of over 3 h, or even only one step of at least 4 h, can then be considered. The pumped flow rate is chosen so that the well is not dewatered. The observation of recovery of water levels is at least 2 h, until the water level returns to somewhere near the initial static level. On the other hand, if the flow rate has been underestimated, additional steps may be used.

### 3.1.3 AQUIFER TEST: DURATION OF PUMPING

There are numerous parameters that have to be considered when choosing the pumping duration of an aquifer test. The main ones are the type of aquifer and the degree of accuracy of the interpretation that needs to be reached.

Economising on the pumping duration is not recommended and the general rule is to continue the pumping until a steady state or quasi-steady state is reached. At the beginning of the test, the drawdown develops rapidly and it will deepen more slowly after some time. This apparent stabilisation of the dynamic level is not yet a steady flow state and the cone of depression will continue to extend slowly until the recharge from the aquifer equals the pumping rate.

Under average conditions, the quasi-steady flow state is reached in a confined aquifer after 24 hours, and in an unconfined aquifer after 2 or 3 days. A planned pumping duration of a minimum of 48 hours is recommended in a confined aquifer and 72 hours in an unconfined aquifer.

### 3.1.4 NUMBER AND POSITION OF PIEZOMETERS

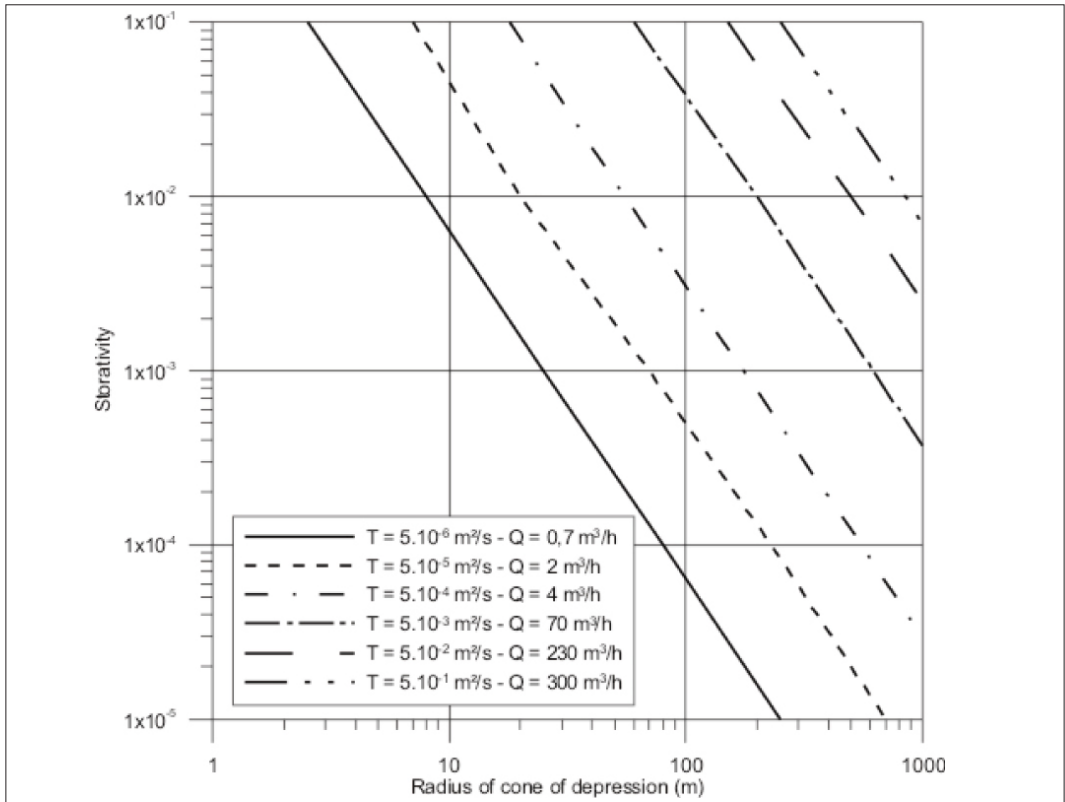
The piezometers considered here are observation wells to monitor water level.

Their number depends on the amount and degree of accuracy of the estimates of aquifer hydraulic parameters needed (Table 6.XI). To carry out a well test, no piezometer is needed because the dynamic level has to be monitored in the pumping well. The local transmissivity of the aquifer can generally be estimated from single well test with Theis's recovery method. However, a piezometer is needed to estimate the storativity of the aquifer because it can not be accurately estimated from the pumping-well data alone.

To carry out an aquifer test, one piezometer is needed to estimate the hydraulic characteristics

**Table 6.XI: Estimated number and position of piezometers required.**

Test	Objective	Required number of piezometers	Distance from the pumping well
Well test	Well characteristics	0	—
	Well characteristics + local transmissivity	1	10 m – 50 m
Aquifer test	Hydraulic characterisation	1	20 m – 100 m
	High accuracy in hydraulic characterisation	3	10 m – 200 m



**Figure 6.22: Estimation of radius of cone of depression after 2 hours of pumping.**

of the aquifer without heavy influence of the pumping process (head-loss in the pumping well). The advantages of having more than one piezometer are that the surface area of aquifer under observation will be larger and that the drawdowns measured in a minimum of 3 piezometers can be analysed in two ways: by time/drawdown and distance/drawdown relationships.

The piezometers should be placed not too near to the well, but also not too far from it. The appropriate distance depends on the way the cone of depression will develop while pumping, and can be easily estimated from forward calculations using software such as AquiferTest Pro. Figure 6.22 presents the estimation of the radius of the cone of depression according to the hydraulic characteristics of the aquifer.

## 3.2 Test implementation

### 3.2.1 VERIFICATION OF SITE

Conditions of access to the site and ease of installation of the pumping equipment (pump and generator) need to be assessed.

It is important to verify that there is not another well being exploited in the vicinity of the area under test. If that turns out to be the case, exploitation must stop (if possible 24 h before the beginning of tests) and any operational wells may be used as piezometers during tests.

The water pumped must be deposited as far as possible from the well under test. It is possible that water discharged by the pump can infiltrate quickly enough to recharge the aquifer, giving a false picture of stable drawdown. The point of discharge must be chosen according to site conditions (notably the permeability and thickness of the terrain), but a discharge outlet at about 50 to 100 m from the

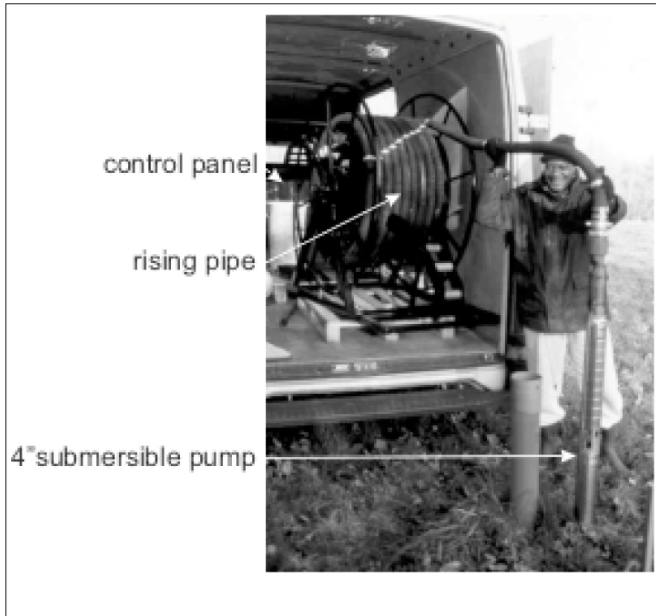


Figure 6.23: ACF pumping-test kit.

pumped well would seem to be a minimum.

### 3.2.2 EQUIPMENT REQUIRED

A standard ACF pumping test kit has been developed to carry out the whole process of well testing (Figure 6.23). It also includes the necessary equipment for test monitoring.

Basic requirements are a measuring tape of about 3 m (for measuring height of reference marks in relation to ground level, diameter of well etc.), a piezometric probe, two chronometers for time measurements, and one calibrated container for measuring flow rates.

For sufficient accuracy in flow-rate measurements, the container-filling time must be between 30 and 60 s (see Chapter 3). The use of a flow meter greatly facilitates the performance of tests. It is however advisable to check its accuracy using the calibrated container.

The conductivity, temperature and pH of the water should be measured regularly during pumping. In this way, changes in the water quality can be indicated, and then interpreted together with the borehole cuttings and the pumping test.

### 3.2.3 HUMAN RESOURCES

A team of three people is sufficient to carry out common tests. The team leader is responsible for data-plotting on record sheets, while two operators are put in charge of setting up the equipment and taking measurements (flow rates, water levels, times, water quality).

A hydrogeologist must define the type of tests to be carried out, and interpret the data.

### 3.2.4 TEST MONITORING

#### *Measurements*

During the test, it is necessary to take measurements of time, water level, and flow rate. Record sheets for standard tests are illustrated in Annex 9. Measurements of time are taken very frequently at the beginning of each pumping and recovery period; their frequency is entered in the record sheets.

For every measurement of time, there is a corresponding measurement of water level. Before the beginning of tests, the static level in the well is noted in relation to a reference mark, which then becomes the reference for all level measurements in the operation. Usually, this reference mark is the top of the borehole casing: its height in relation to ground level is also noted. The tip of the electric probe is then located a few cm above the static level. It is strongly advisable to use guide tubes (1" PVC or GI) to slide the probe inside the pumping well. This helps to avoid fouling the probe with the pipe or cable of the pump.

There must be a facility for adjusting the flow rate as quickly and as precisely as possible. The use of two control valves on the discharge pipe is sometimes essential. These valves are pre-set according to the required suction head and flow-rate. A good position for the calibrated container must also be ensured: flow-rate measurements must be able to be taken as easily as possible, without modifying the suction head for every measurement.

### *Monitoring*

The curve  $s = f(t)$  must be drawn on semi-logarithmic paper for every pumping step during the tests. The curve is compared to the theoretical ones and if it shows some actual 'anomalies' this helps to decide the progress of the tests (see Section 1).

While conducting the pumping test, one should be flexible and adapt the test design to the well behaviour. A little common sense, sufficiently long pumping times, constant flow rates, and a pump outlet sufficiently distant from the boreholes usually provide the right conditions for a successful test.

## 3.3 Reporting

The pumping test report should contain the following:

- a location map of the wells and boreholes;
- a summary of main interpretation results and recommendations;
- the lithological and equipment logs of the tested boreholes;
- diagrams of field data and the interpretation process, i.e. diagnostic and specific graphs;
- tables of field measurements.

III

Water supply



# Wells

## A WELL CONSTRUCTION

<b>1</b>	<b>Modern wells</b>	241	2.3.1	<i>Pre-cast well rings</i>	251
1.1	Surface works	242	2.3.2	<i>Casting the intake column at the bottom of the well</i>	252
1.1.1	<i>The wellhead</i>	242	2.3.3	<i>The cutting ring</i>	252
1.1.2	<i>Apron and drainage</i>	242	2.3.4	<i>Sinking the intake column under its own weight</i>	252
1.2	Manual water drawing	242	2.3.5	<i>Gravel pack</i>	252
1.2.1	<i>Pulleys and winches</i>	243	2.4	Developing the well	252
1.2.2	<i>The “shaduf”</i>	244	2.5	Use of explosives	254
1.3	Diameter	244	2.6	Deep wells in Mali	255
1.4	Well lining	245	<b>3</b>	<b>Rehabilitation of wells</b>	255
1.5	Intake column	245	3.1	Why rehabilitate?	255
<b>2</b>	<b>Construction techniques</b>	245	3.2	Rehabilitation of the well lining	256
2.1	Digging	245	3.2.1	<i>Rehabilitation of the existing lining</i>	256
2.2	Lining	246	3.2.2	<i>New lining and intake</i>	256
2.2.1	<i>Stable ground, bottom-up lining</i>	247	3.2.2.1	Narrow wells	256
2.2.2	<i>Unstable ground, top-down lining</i>	248	3.2.2.2	Wide unlined wells	257
2.2.3	<i>Soft sands, sunk intake and lining</i>	248	3.2.2.3	Backfilling the excavation	257
2.2.4	<i>Anchorages</i>	250	3.3	Cleaning and deepening	257
2.2.5	<i>Lining thickness, concrete mixes and reinforcement</i>	250	<b>4</b>	<b>Disinfection</b>	258
2.3	Independent intake	251			

A well is usually dug manually to reach an aquifer situated at some depth below the ground. The depth and diameter of the well vary according to local conditions. Throughout history, people have dug wells to ensure a permanent water source.

### 1 Modern wells

Traditional wells are rarely lined, or only for part of the depth, usually with wood, so that the well must be regularly re-dug and rebuilt. As they are simple holes in the ground, these wells are rarely protected from surface pollution (contaminated water).

Some wells are constructed using stone or brick. The best examples are the pastoral wells constructed during colonial times in the Sahara, several dozen metres deep, and some 2 to 3 m across.

Wells of more modern type, which are the subject of this chapter, are lined in reinforced concrete for the whole of their depth, from the surface to the intake section. Construction techniques are tried and tested, and pastoral wells can reach 100 m in depth. They have a width of 2 m to be able to exploit Sahelian aquifers, and they are open and often equipped with several pulleys. Significant quantities of water are extracted (using animal power) to supply herds of animals.

Village wells are more modest, running to depths of 20 to 30 m, and equipped with manual water-drawing systems (scoops, pulleys, winches or handpumps).



### Box 7.1

#### Combined well.

In certain sedimentary basins, there are captive aquifers covered by impermeable levels situated several dozens or even hundreds of metres in depth, but with static levels close to the surface. These aquifers, reached by boreholes, are exploited from wells whose depth varies with the static level. This facilitates drawing by hand. The intercalated continental aquifer levels of the Sahara (Mali, Niger) are often of this type, and do not need pumps, which would be difficult to manage in this context (nomadic population).

These wells act like underground, water-tight storage tanks. They are dug next to the borehole or around it, and connected to it with a horizontal tube welded to the casing, fitted with an open stop-valve to the well-cistern or with a ferrule strap.

This type of well provides a particularly useful water storage solution for the exploitation of aquifers with poor flows. An example of a combined well, constructed by ACF in Asia, is given in Chapter 8D.

The enormous advantage of the well in relation to the borehole is its storage capacity (related to its diameter) and the possibility of manual water drawing. Its permanence makes it very suitable for the conditions of the Sudan-Sahelian region, and other isolated or particularly remote regions. The cost of construction is considerable, so it should be well built and durable.

## 1.1 Surface works

The works at the surface of the well are an essential component in terms of water quality, because they protect the well from infiltration by surface water and facilitate access and water drawing. They are designed to drain surface water away from the well, to limit the risk of falling objects, and to prevent access by animals. Design details are given in Annex 14.

### 1.1.1 THE WELLHEAD

A low wall built around the top of the well, forming an extension of the well lining, secures and protects the well against mud and sand falling in from the surface.

On wells intended to be covered and fitted with a handpump, it is recommended that the well-head should be lower (less than 0.5 m, thickness 0.2 m). A high wellhead (greater than 0.5 m, thickness 0.3 m) is more suitable for wells situated in the Sahelian region (protection against sandstorms).

### 1.1.2 APRON AND DRAINAGE

A slab of reinforced concrete directs wastewater towards a drainage channel (minimum slope 5% and minimum length 3 m). The channel is terminated by a toe at the outlet.

If no natural drainage is available (to low-lying land or a ditch), the construction of a soakaway should be considered (see Chapter 13). It will however quickly become blocked by contaminated water (mud, grease, soap etc.) and must be regularly maintained to remain efficient.

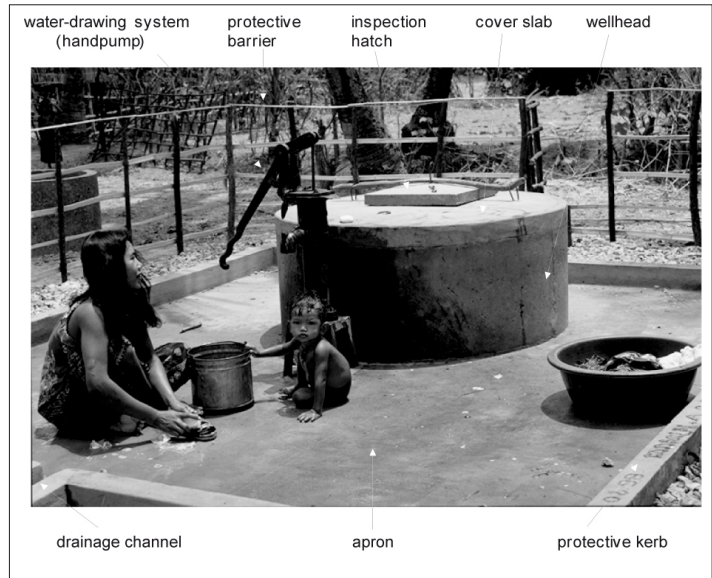
One solution is to drain the water to a small garden.

A clean area of stones can be laid around the apron.

The construction of a protective fence and troughs for animal watering may also be considered, depending on the context (Figure 7.1).

## 1.2 Manual water drawing

Water-drawing systems are of fundamental importance for the water quality. Their design must take account of the risk of contamination at the water point. A bucket and wet rope come into contact



**Figure 7.1: Well surface works**  
(ACF, Cambodia, 1998).

with the ground and become contaminated with mud, faeces etc. every time water is drawn. With every immersion therefore, the bucket and rope contaminate the well water. Also, as all users have their own bucket, the risks of pollution are multiplied.

Water drawing by bucket or scoop is very frequent. Although the installation of a handpump is often the recommended solution, is not always suitable (heavy demand on pastoral wells, maintenance of the pump, large variation in water level etc.). Some examples of simple water-drawing systems are given below. These systems must fulfil the following criteria:

- ensure the necessary flow for the population being served, as well as easy and safe water drawing;
- designed so that containers and ropes are used only for water drawing and remain permanently at the well;
- prevent ropes and containers lying on the ground and risking contamination.

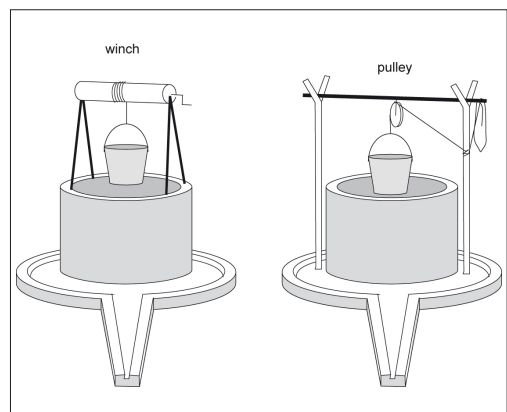
### 1.2.1 PULLEYS AND WINCHES

These (Figure 7.2) must be durable and appropriately designed (height and number of pulleys) for user satisfaction.

Pastoral wells are often equipped with several pulleys fixed to wooden forks arranged around the wellhead to allow several people to draw water simultaneously for herds (by animal traction).

The winch avoids the rope dragging on the ground and becoming contaminated, but this system is not always accepted by users, because it does not provide sufficient water flows for pastoral wells.

The ‘delou’ (pulley and animal traction) is used essentially for irrigation.



**Figure 7.2: Manual water drawing.**

## 1.2.2 THE 'SHADUF'

This system, used widely in Asia in shallow wells, protects the water from surface pollution transmitted by the bucket. It is also very convenient for the removal of spoil from excavations (Box 7.2).

### Box 7.2

#### Working principle of the shaduf.

Define point A (Figure 1), the lowest level from which water is to be drawn (the dynamic water level during water drawing).

Ensure that the lift handle can be reached by the user.

The distance between the fulcrum of the shaduf and the well (OB) should be such that the arc defined by the counterbalance is large enough.

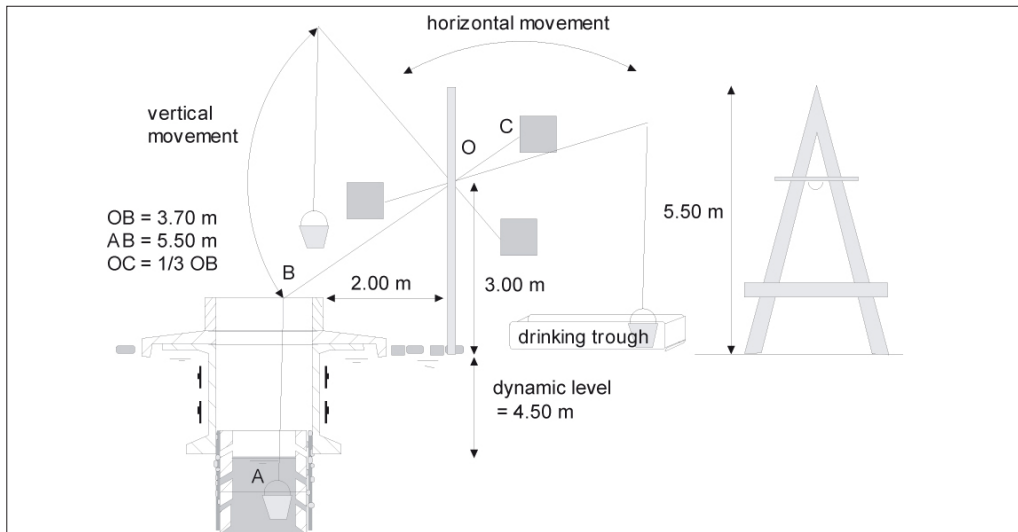
The lifting pole should be rigid (wood), and the flexible fixings at its extremities should be short.

The counterbalance should be located at the end of the lifting beam, one third of the length of OB from the fulcrum.

The counterweight is determined so that a container full of water can be raised without effort; the effort is exerted when lowering the scoop into the well.

The fulcrum must permit rotation in both vertical and horizontal planes (fixings of leather or rubber).

**Figure 1: Shaduf.**



## 1.3 Diameter

The diameter of a well varies depending on use, depth and flow. Larger diameters are used for pastoral wells (multiple users) or for shallow or poorly productive aquifers. The well has significant storage capacity and refills when not in use.

There are two construction techniques:

- independent intake: the intake column is telescoped into the well lining (Figure 7.3);
- intake lining: perforated well rings at the base of the well lining.

**Figure 7.3: Lined well with independent intake.**

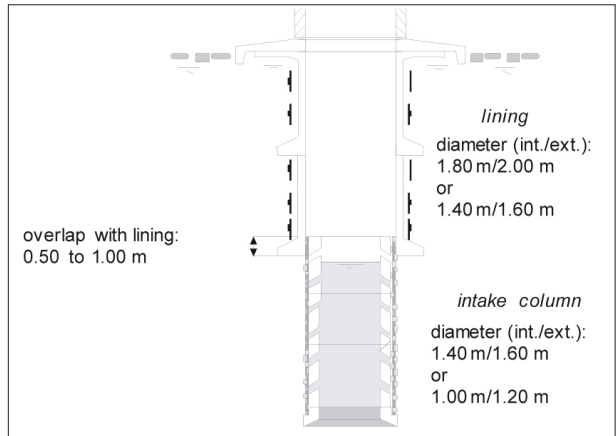
Well diameters commonly used are 1 to 1.2 m inside diameter for wells with intake linings (less than 15 m deep).

For wells with independent intakes:

- lining 1.40 m and intake section 1 m internal diameter for village wells intended for drinking water;
- lining 1.80 m and intake section 1.4 m internal diameter for pastoral wells, subject to much higher usage and allowing 6 people to draw water simultaneously. For wells wider than this, the volume of materials involved is enormous.

Wells of smaller diameter are too narrow to work easily inside.

Wells of smaller diameter are too narrow to work easily inside.



## 1.4 Well lining

The lining extends from the surface down to the static level of the water table. Its function is to retain the earth and rock sides and to prevent infiltration of surface water or water from unwanted surface aquifers (polluted or saline water).

The most effective technique is lining *in situ* using metal shuttering during the construction of the well. The advantage of this technique is that it provides an integral, one-piece reinforced column, which is much stronger and more water-tight than a column of rings stacked one on top of another. Where rings are used, sealing of the column is poorer, and it is not unusual for lateral deflections of the column to occur because of ground movements.

## 1.5 Intake column

This is the immersed section of the well, and its role is to admit water while preventing ingress of fine solids (sand, silts etc.). It is made of perforated (or porous) rings and designed to provide a sufficient depth to ensure water supplies all year round, even during dry periods.

Ideally, this section of the well should be dug during a low-water period (lowest static level). If it is not done at this time, the water level in the well will be higher.

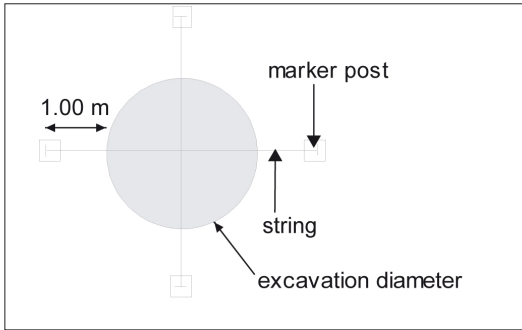
The height of water in the intake section of the well depends on annual groundwater variations and the water output from the well (see Chapter 6).

# 2 Construction techniques

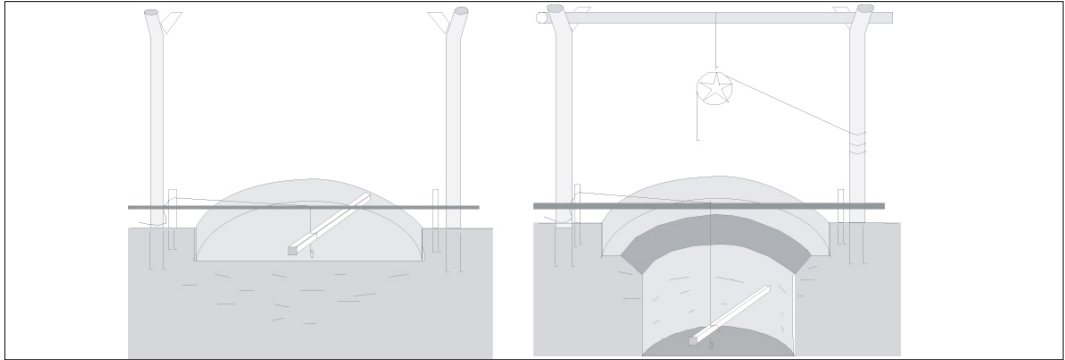
## 2.1 Digging

Digging (or sinking) a well must be as close to the vertical as possible throughout the depth of the excavation. It is recommended to mark out on the ground a circle equal to the diameter of the excavation, and to mark the axis of the excavation with a plumb-line (Figure 7.4). The diameter of the excavation should be checked regularly using a gauge (Figure 7.5).

Digging takes place from the centre of the well and moves toward the wall. Excavated material is regularly lifted to the surface using a bucket or kibble.



**Figure 7.4: Marking the axis of excavation.**



**Figure 7.5: Use of a gauge.**

Over the top of the excavation, a tripod fitted with either a motorised or manual winch is set up for raising or lowering men and materials. In shallow wells, this tripod can be replaced with a gantry carrying a pulley (for safety, it should have a locking and braking system for use when lowering the rope).

Digging can be done using a grab bucket, raised by a free-fall winch (motorised crane). This type of equipment is especially useful for dredging wells and for digging in loose ground or below the water table.

## 2.2 Lining

The techniques used for installing the lining and the intake section depend on the stability of the ground encountered during the excavation. There are three distinct techniques (Table 7.I).

**Table 7.I: Techniques used for installing lining and intake section.**

Nature of ground	Lining	Intake section
Stable ground	Bottom-up <i>in situ</i> lining	Independent intake with cutting rings
Ground unstable and/or well of more of 10 m depth	Top-down <i>in situ</i> lining	Independent intake with cutting rings
Loose ground and/or well of less than 15 m depth	Sunk lining on cutting ring	Intake lining with perforated rings below the lining

### 2.2.1 STABLE GROUND, BOTTOM-UP LINING

In ground that can be dug with a pick, and which does not present a risk of crumbling (some sandstones, clays etc.), the technique consists of lining the well from the bottom upwards. The excavation is open from surface to water level (Figure 7.6).

The first section of the lining is poured at the bottom of the excavation, at the same time as the base anchorage. The steel reinforcement is then put in place, its length being greater than the height of the shuttering, in order to tie it into the next section up (see Figure 7.8A).

The shuttering is lowered, centred using the plumb-line, and set vertical. Two or three shuttering sections are placed at a time, so that concrete sections two or three metres high can be poured in one go.

The concrete (350 kg cement per m<sup>3</sup>) is poured, and vibrated with a jackhammer or a vibrator rod. Shuttering can be removed after 8 hours.

If the ground shows signs of instability during digging, the operation will have to be stopped, and the lining method changed to top-down, as described below.

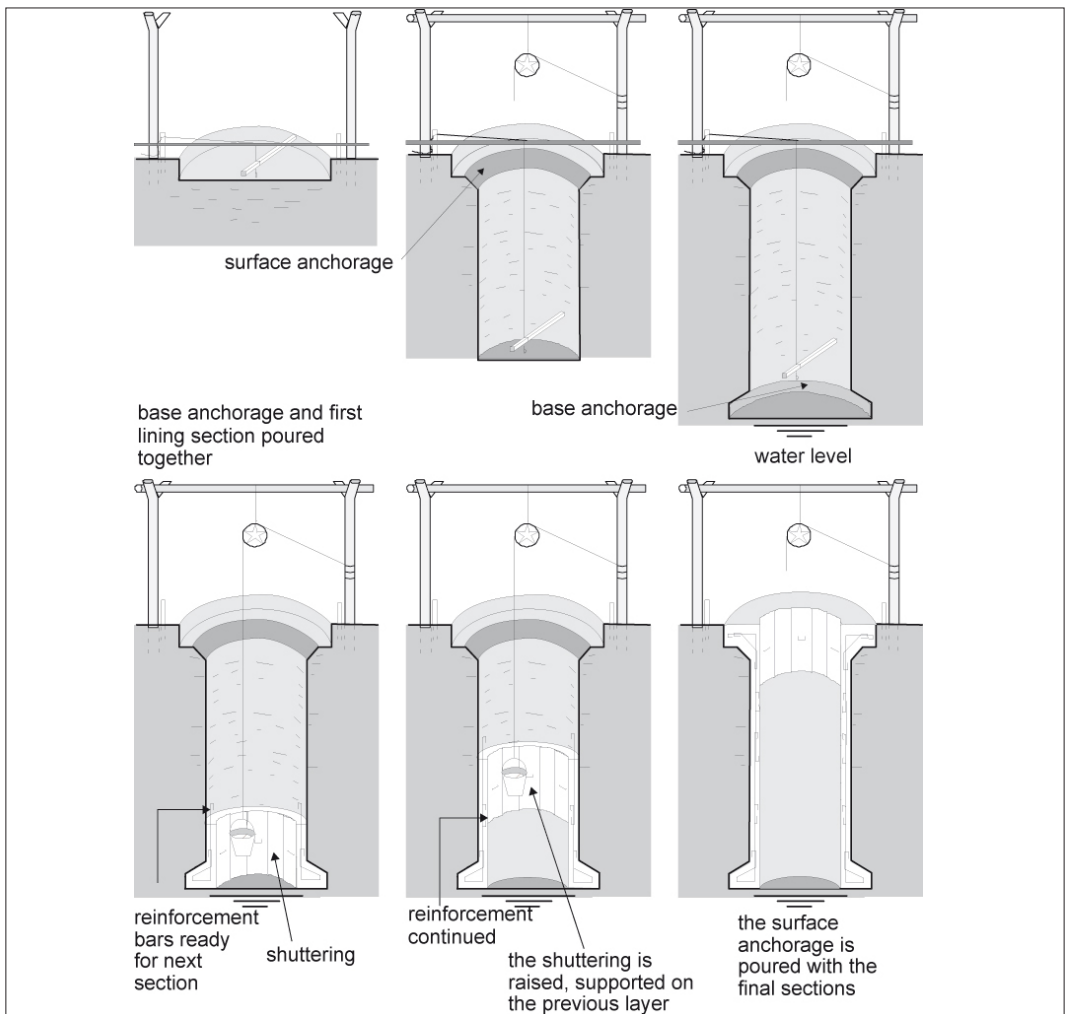
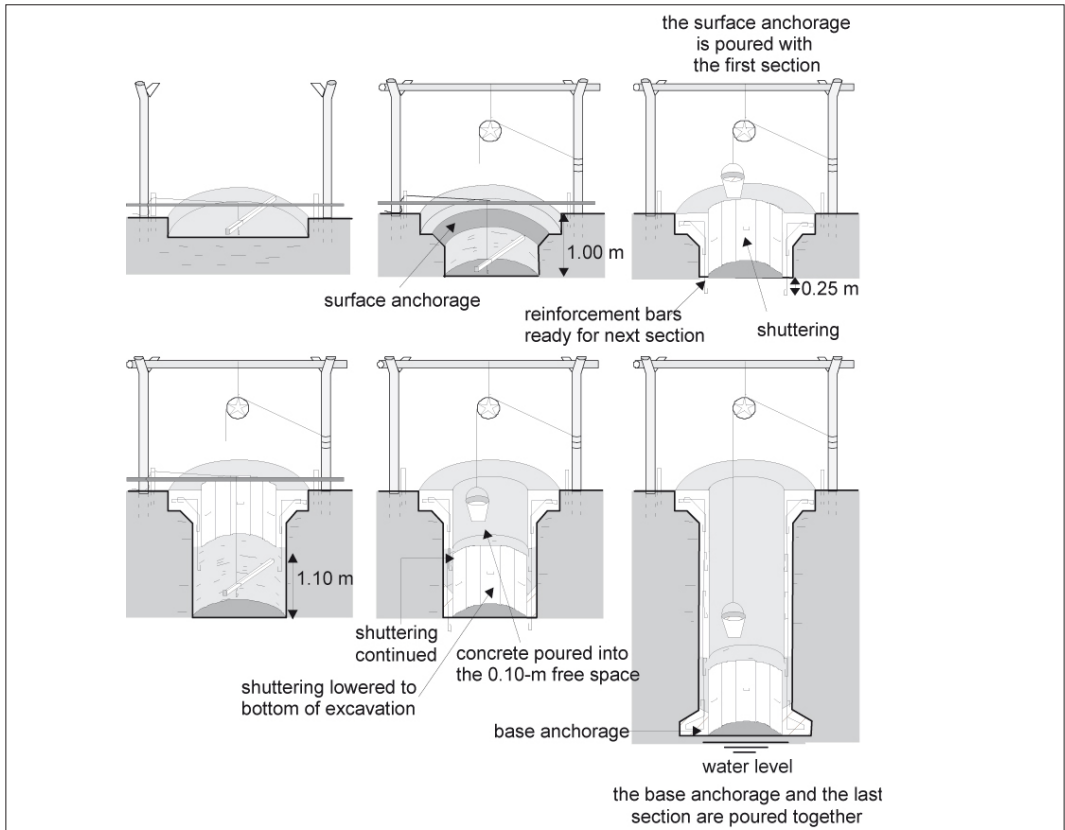


Figure 7.6: Bottom-up lining.



**Figure 7.7: Top-down lining.**

### 2.2.2 UNSTABLE GROUND, TOP-DOWN SHAFT LINING

In ground where there is a danger of collapse (sand, gravel etc.), it is essential to construct the lining in one-metre sections while the well is being dug (Figure 7.7).

In practice, when the first metre is dug, and the site of the surface anchorage has been cleared, the reinforcement is installed (Figure 7.8B) and the shuttering put in place. The process then involves:

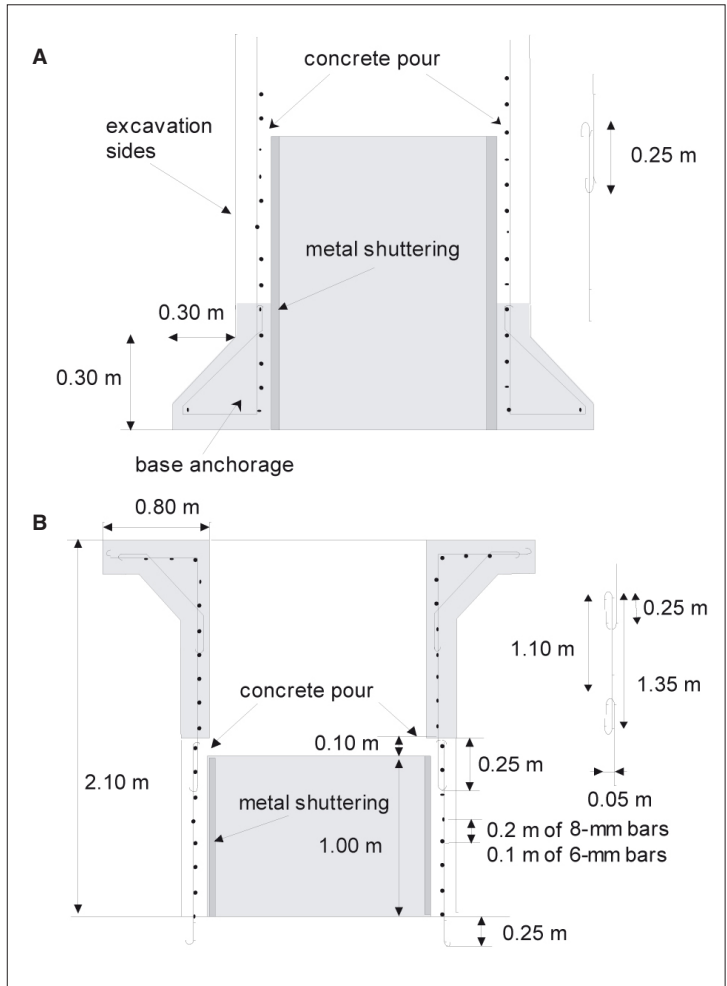
- digging a section 1.10 m in depth;
- fixing reinforcement and fixing to the previous set of bars (vertical height of reinforcement 1.35 m);
- placing shuttering leaving 0.10 m clearance above it;
- pouring the concrete and filling the 0.10 m gap up to the lining section immediately above;
- removal of shuttering after 8 hours.

### 2.2.3 SOFT SANDS, SUNK INTAKE AND LINING

This technique is applied in soft sand, or with shallow wells (less than 15 m). It is currently used for the construction of village wells or for market gardening.

The base of the lining, made up of perforated rings, forms the intake column. The intake and lining form one continuous structure, which is installed by undercutting, as with an independent intake column (see Section 2.3).

This technique does not allow anchorage at the well bottom, and the column is suspended from the surface anchorage, which must be constructed with a maximum of care. Also, installing a gravel

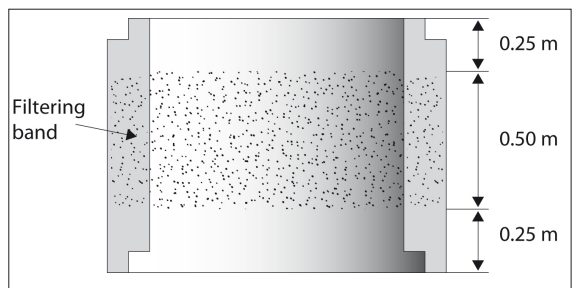


**Figure 7.8: Reinforcement methods for bottom-up (A) and top-down (B) linings.**

pack is difficult, and the intake level must be determined beforehand (the number of catchment-section rings being decided before reaching the aquifer).

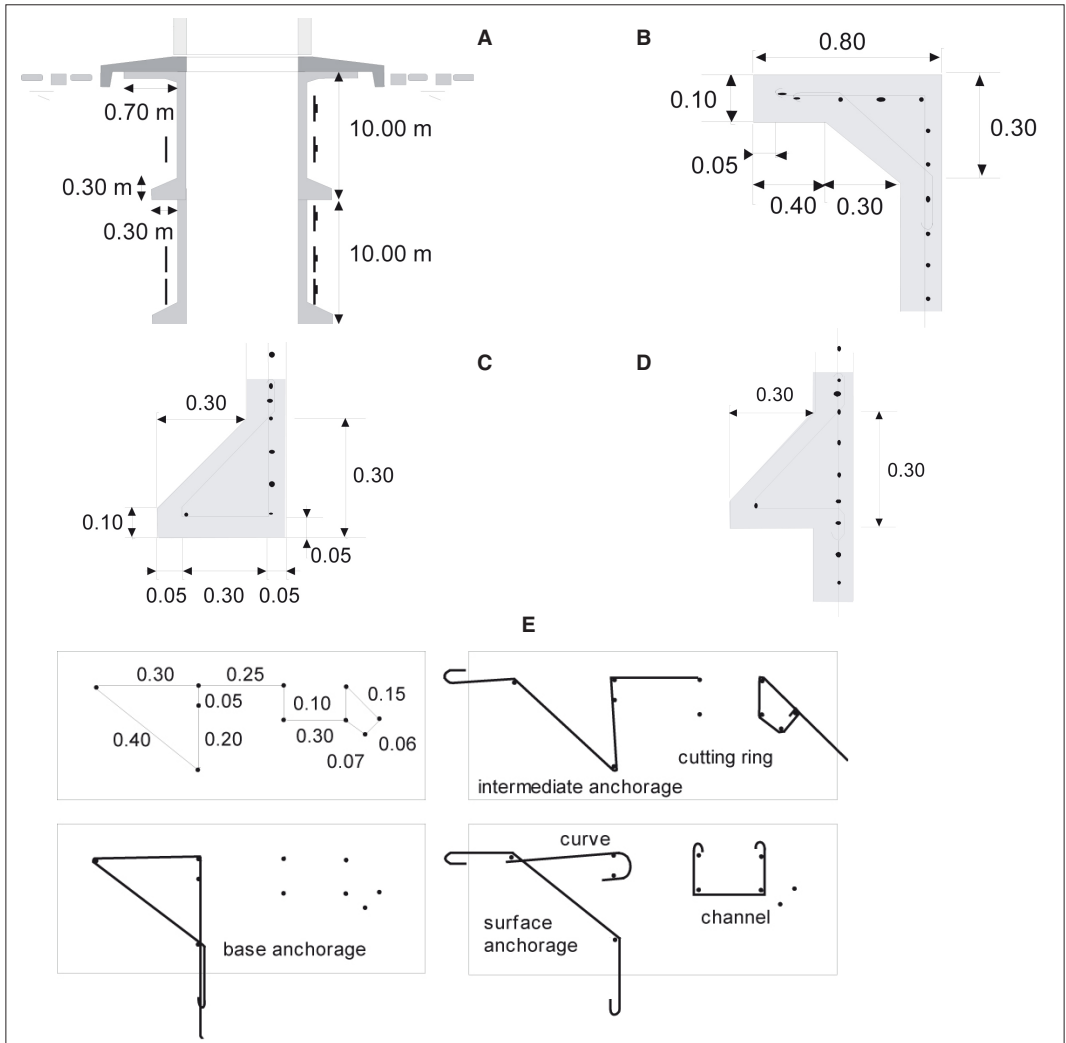
For this kind of well, *filtering concrete rings* may be used. These rings are made of three bands (Figure 7.9), two impermeable and one porous. The rings are not reinforced and the porous concrete band is made exclusively with cement and gravel (1 volume of cement to 4 volumes of gravel). As these rings are not reinforced, the cement dosage and the time of drying have to be strictly respected. Moreover they are not recommended in places where the soil is unstable. The outside diameter should not exceed 1.30 m.

The advantage of this technique is to filter the water (to keep out sand) even if no gravel pack is installed. These rings are also cheaper and lighter than normal ones.



**Figure 7.9: Filtering concrete ring.**





**Figure 7.10: Reinforcement for lining anchorages.**

**A: general view. B: surface anchorage. C: base anchorage. D: immediate anchorage. E: pattern for making reinforcement elements, made of a thick plank, 1.1 m long and 0.5 m wide with short lengths of reinforcement bar inserted in it.**

## 2.2.4 ANCHORAGES

Anchorages are essential and are cast at the top and bottom of the well, and every 10 m for wells of more than 20 m in depth. Their role is to absorb the vertical forces created by the weight of the column.

The surface anchorage is in the form of a crown 0.80 m in width at the top of the shaft lining; base and intermediate anchorages are 0.30 m wide (Figure 7.10).

## 2.2.5 LINING THICKNESS, CONCRETE MIXES AND REINFORCEMENT

The thickness of the lining and the mesh of the reinforcement are theoretically determined by on the forces to be resisted. However, the variation in forces imposed by the ground on the lining are

small and difficult to measure precisely (the forces are compressive). Design is simplified by standardising the thickness of linings and reinforced concrete well rings to 10 cm and the steel reinforcement to 8 mm diameter with a mesh of 20 cm (or 6-mm bars with a mesh of 10 cm).

Concrete is made with 350 kg of cement per m<sup>3</sup> for the lining and 400 kg/m<sup>3</sup> for the intake section; mortars at 300 kg of cement per m<sup>3</sup>.

## 2.3 Independent intake

This type of intake is independent of the well lining. It consists of a column of smaller-diameter perforated well rings telescoped into the well lining (Figure 7.3).

The excavation is taken down to the static level and is then pumped out. The column of well rings is then sunk by a cutting ring (see Section 2.3.3) to descend under its own weight: flooding with water is a critical stage in the construction of a well. The well is kept dry by pumping (see Chapter 9) or using a bailer operated by a motorised crane.

### 2.3.1 PRE-CAST WELL RINGS

The intake section is made up of perforated reinforced concrete rings, stacked up from the bottom of the well. There is a risk that they become destabilised and shift sideways during undercutting, which would jeopardise the process. To facilitate lowering the rings, their height is limited to 50 cm. They are lowered to the bottom of the well using a winch (see Figure 7.13 B & C).

The perforations, spaced at 10 cm intervals, are made using 8 or 10-mm reinforcement bars, protruding through holes in the mould. The bars should be smeared with oil and turned regularly to facilitate removal (Figure 7.11).

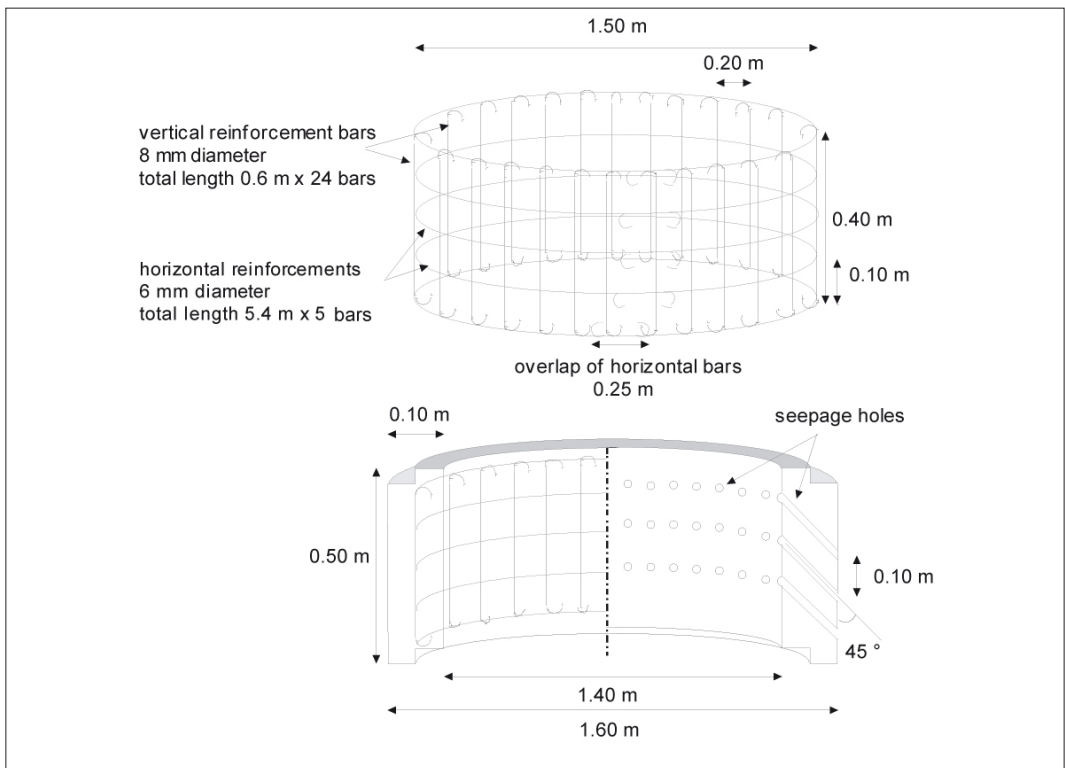


Figure 7.11: Reinforcement of perforated rings.

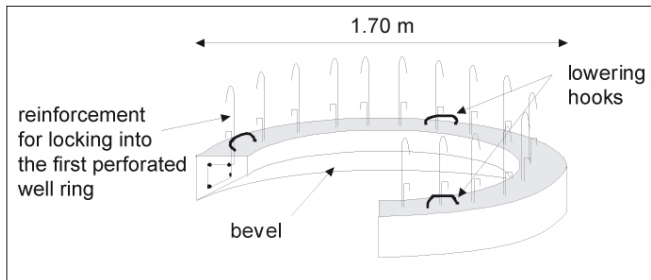
### 2.3.2 CASTING THE INTAKE COLUMN AT THE BOTTOM OF THE WELL

Prefabrication can save a week of total construction time. However, it is preferable to pour the column directly at the bottom of the well, locking the sections into one another by overlapping the reinforcement.

The mould is positioned at the bottom of the well. The reinforcement bars on the first intake ring are locked into bars protruding from the top of the cutting ring, and then the concrete is poured. The mould may be removed by the following day, and then a second section is poured.

### 2.3.3 THE CUTTING RING

This is a bevelled concrete ring, wider than the other rings, laid at the base of the intake column (Figure 7.12). Its role is to facilitate lowering the column into the ground, and to provide sufficient space to insert the gravel pack (see Section 2.3.5) between the rings and the ground around the well.



**Figure 7.12: Cutting ring 1.4 / 1.6 m diameter.**

### 2.3.4 SINKING THE INTAKE COLUMN UNDER ITS OWN WEIGHT

Four 4-cm thick wooden beams are inserted into the space between the lining and the intake column, extending about 10 cm above the top of the column, to act as reference markers and to check that the column is descending vertically (Figure 7.13. A-C).

The well is then dug inside the column, regularly clearing the bevel of the cutting ring around its perimeter so that it descends vertically. If a beam jams, earth is dug out from under the cutting ring on the side opposite the beam to straighten the column.

A gravel pack (see below) is forced into the space between the column and the surrounding earth as the digging proceeds.

Finally, if the earth is unstable and very fine grained, a concrete base consisting of two semi-circular slabs pierced with 10-mm holes spaced 15 cm apart is placed at the bottom of the well, on a bed of gravel.

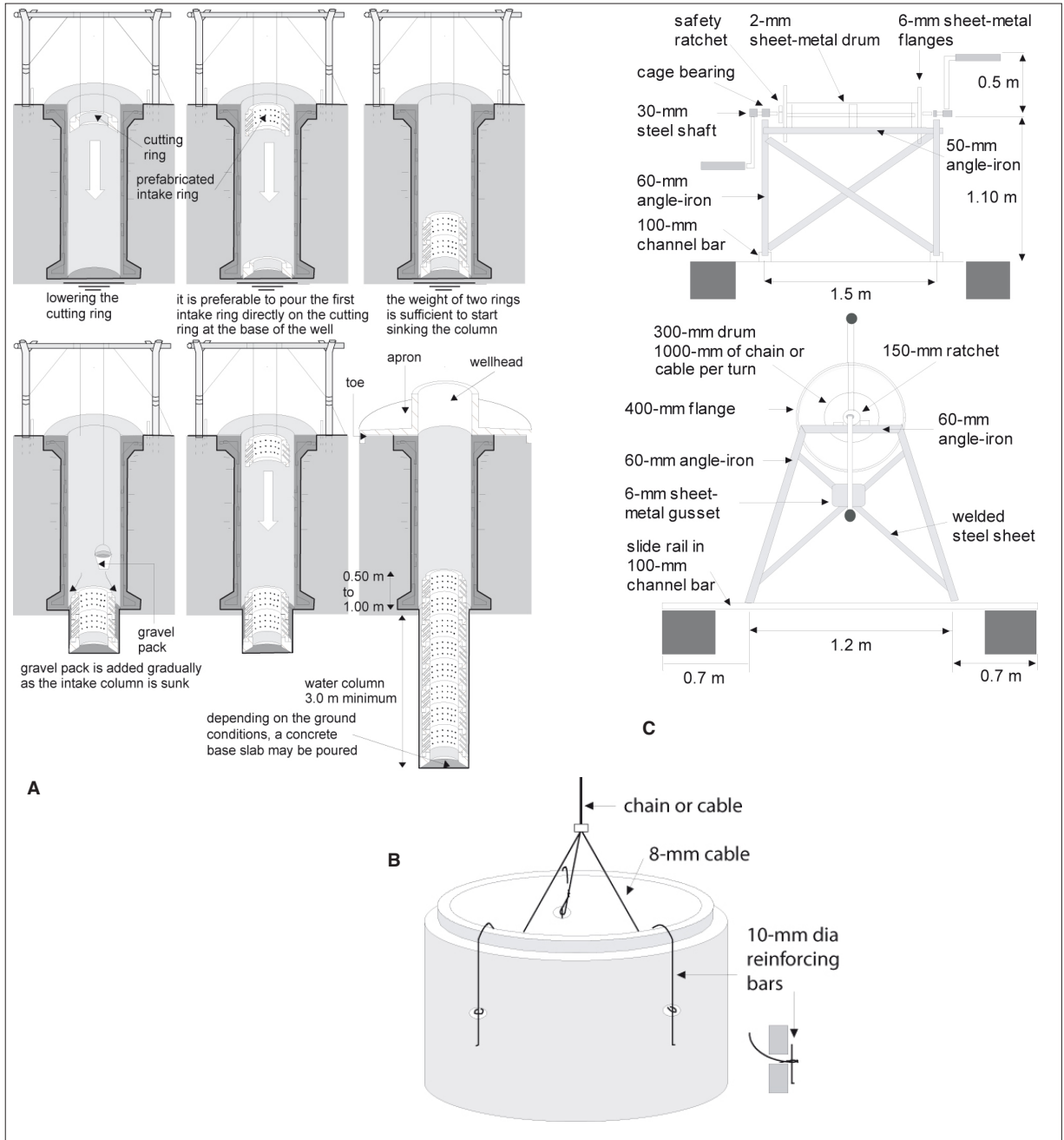
### 2.3.5 GRAVEL PACK

This consists of 10 to 15-mm gravel, preferably siliceous and rounded (avoiding lateritic gravels and limestone), distributed evenly around the well intake column to a thickness of 5 cm. Its role is to keep out fine particles of earth while admitting water. It is therefore an essential part of the intake.

## 2.4 Developing the well

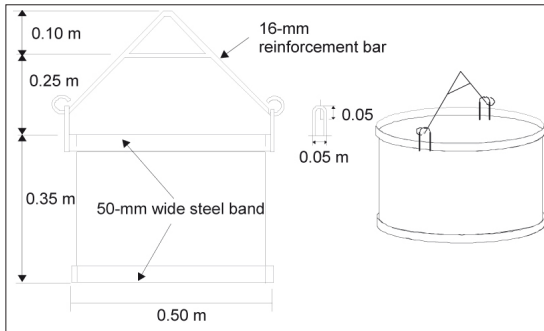
Once the work is finished, the well is developed. It is an important operation for removing fine particles and increasing permeability around the intake in order to increase the specific flow (sometimes considerably). It also allows complete cleaning of the well, and estimation of its yield (see Chapter 6). Two simple methods are used for this purpose:

– *surging with a bailer*. The method consists of agitating a 50-litre bailer (Figure 7.14) below the water surface in the well, plunging it up and down like a piston. These phases of surging alternate with phases of pumping, first at a low flow, then progressively increasing the flow until clear water is obtained;



**Figure 7.13: Sinking an independent intake.**

**A: sinking stages. B: lifting system for rings. C: winch for lowering rings.**



**Figure 7.14: A bailer.**

– *pumping*. By pumping in stages of increasing flow, the well is cleared of fine particles from around the lining. Ideally, a dewatering pump designed to handle turbid water should be used, but a submersible pump (see Chapter 9) can also be used.

## 2.5 Use of explosives

ACF teams dig wells in very different geological contexts around the world. Digging of hard formations may often be done with a jackhammer. However, in certain geological contexts (presence of hard rock that is only slightly weathered, or not at all), using a jackhammer is tedious, if not impossible (extremely slow progress, heavy wear of the tools and fatigue of the digging teams). Nevertheless, in some cases it might be necessary to get through layers of hard rock in order to reach an aquifer in fractured and weathered rock below.

On the Ifoghas massif in Mali, in 1998, the ACF teams overcame this type of problem using explosives.

After several years of experience, the results may be considered positive. The rates of progress in the unweathered or slightly weathered granite formations of the region are variable, around 25 cm per blast. Excavating a well using explosives costs about twice as much as digging by hand (excluding the cost of lining the well).

The methodology adopted can be summarised as follows:

- drilling the blasting holes (between 6 and 12, depending on the blasting plan), about 1 m deep;
- inserting the explosive packs with their detonating cords;
- packing clay in the blasting holes;
- connecting the detonating cords (6 to 12) to an electrical detonator;
- connecting the detonator to a battery or blaster;
- blasting;
- waiting for the evacuation of the blast gases;
- clearing the debris and then shaping the sides of the well with a pneumatic drill.

In order to perform such a technique a special set of equipment must be purchased: a pneumatic drill and air compressor, electrical detonator, dynamite packs, detonating cords, and electric cables and a battery (or blaster).

*Note.* – Due to the dangerous nature of the materials used, it is necessary to train the teams in mining techniques. In each country, specific legislation and regulations govern the use of explosives. Therefore, it is compulsory to involve the relevant government structures in the development of a training programme on the use of explosives before any intervention. Regulations (and hence the training) cover the purchase, transport, storage and use of explosives. It is essential to contact the appropriate technical service or ministry, to obtain the necessary permits to carry out this activity. In cases where a competent authority does not exist in the country, this kind of activity can only be performed if there is a specialist who ensures the security of the construction site.

## 2.6 Deep wells in Mali

The first so-called modern wells to be built in Mali date from the French colonial time. They are still in service and have the characteristics of a modern well of 180 cm diameter. Due to the hydro-geological conditions in northern Mali the depth of some these wells exceeds 100 m. In such a context, the well-digging technique does not change in itself, but the materials and equipment used must be adapted in order to facilitate the work of the well-digging teams.

ACF-Mali builds independent intake wells and cistern wells. The deepest such well that has been built has a total depth of 90 m and some of the cistern wells reach 70 m deep. It is clear that digging wells to these depths involves a number of difficulties. There are several points to be considered:

– *Safety of the teams.* The security rules are the same whatever the depth of the well (helmet, boots, safety rope, harness etc.), but the depth of the construction increases the need for the systematic application of the rules in order to prevent any person or object falling into well. During the construction phase the surroundings of the well must be kept free of all loose objects, and the tools must be lowered into the well very carefully.

– *Pumping equipment.* Beyond 40 m, ordinary dewatering pumps (type DOP 15 N) cannot be used, so it is difficult to remove the water. Initially, a 200-l bailer lifted with a derrick winch was used, but this caused too much strain on the winch motor (Hatz). Currently, the water is pumped with a high-head electric dewatering pump (brand FLYGT, model BIBO 2084 HT 250). This pump is able to extract 10 m<sup>3</sup>/h from a depth of 80 m, and is powered by a 30 KVA generator (pump and parts cost 12 000 Euros, while the generator cost 10 000 Euros).

– *Installing the lining.* The diameter (180 cm), the digging technique and the characteristics of the reinforced concrete are conventional. At greater depths the quality of work needs to be very high at critical points, namely the anchorages (every 10 m), the steel reinforcement, particularly the covering of the steel and the quality of the joints between cast sections (top-down *in-situ* lining). Special care must be taken in the production of the concrete, since its quality ensures the long life of the construction. Concrete quality depends on the quality of the aggregates (cleanliness, hardness, shape and effective grain size) (and the cement (CPA 45 is a good guarantee), as well as the proportions of the materials used. The normal mix for 1 m<sup>3</sup> of concrete is 350 kg of cement (up to 400 kg), 800 l of gravel and 400 l of sand. The depth of the construction often means digging through intermediate aquifers that are not of interest (not perennial). The presence of this water disturbs the laying of the reinforced concrete. In these cases an accelerator and waterproofing compound such as SIKA 4A is used.

– *Disassembling old wells.* As part of the ACF project, old colonial wells are rehabilitated. This rehabilitation requires an initial disassembling phase. For this purpose a grab bucket such as the SECMIL / BP 55 is used. This is suspended from a derrick winch and allows the bottom of a well containing water to be cleaned out. For example, 25 m of sand was cleaned out from one well that was 120 m deep.

## 3 Rehabilitation of wells

### 3.1 Why rehabilitate?

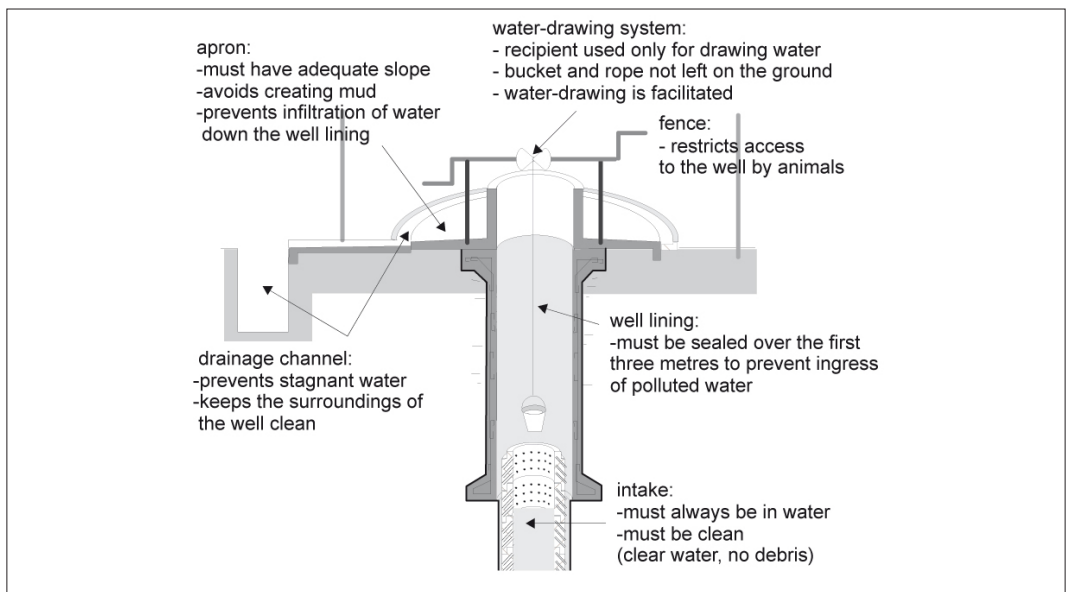
Rehabilitation of a well is often more cost-effective than the construction of a new one, because less work is involved. Moreover, a well already in use by a village or community is governed by established rules which may have to be redefined for a new well.

Inspecting a well to be rehabilitated requires special attention to elements that protect the well from surface pollution during its use, and/or from infiltration of contaminated water (Table 7.II). A rehabilitated well is therefore one that is protected from pollution and that provides a satisfactory flow for its users (Figure 7.15).

**Table 7.II: Routes of pollution to a well (see also Chapter 13).**

**A well must be situated at least 30 m from a source of contamination (latrines, domestic refuse tips etc.). In the majority of cases the distance of 30 m is quite sufficient (no more traces of faecal pollution beyond a few metres), except in fractured ground.**

Route of pollution detected	Possible protection
Surface pollution	Clean water-drawing system (pumps, winches, pulleys, shaduf)
Contamination by rope and bucket	Wellhead, apron and drainage channel
Contamination by surroundings of the well	Protective fence against animals
Infiltration of polluted surface or underground water	Water-tight lining Slab Healthy environment (latrines situated more than 30 m away, no refuse, no wastewater drainage upstream of the well)



**Figure 7.15: Protecting a well from pollution.**

## 3.2 Rehabilitation of the well lining

### 3.2.1 REHABILITATION OF THE EXISTING LINING

Except in the rare cases where the concrete work is very poor, the linings of wells finished in reinforced concrete age well and any cracks can be simply repaired with mortar.

On the other hand, masonry linings must be carefully inspected, and the mortar joints always checked to ensure sealing of the lining, especially the upper part.

### 3.2.2 NEW LINING AND INTAKE

#### 3.2.2.1 Narrow wells

If the well is unlined and of a smaller diameter than the diameter of the lining envisaged, it is best to rebores the well and fit a lining in an identical manner to that used in the construction of a well.

If the well to be rehabilitated includes an old lining (concrete and masonry) in poor repair and difficult to get at, it is possible to cast a new lining inside the old one, throughout its height. This is sometimes termed re-sheathing. However, the lining in place must have a diameter large enough to take a new lining and an intake column.

In the case of lateral displacement of the column, it will have to be demolished, at least partially. The time involved, the equipment needed (rock hammer) and the cost compared with constructing a new well must be carefully estimated before starting such a project.

### *3.2.2.2 Wide unlined wells*

It is often the case that a traditional well collapses so that access becomes precarious.

The diameter of the excavation in place is too large for a lining, so the best solution is to build a column of well rings in reinforced concrete. Preferably, this column should be cast in place, or pre-fabricated and then assembled on site. An independent intake is then inserted.

It is not appropriate to install a top-down lining (too much excavation to do and too much concrete to be poured).

When the underlying ground is hard, for example if it is composed of limestone or sandstone, the base of the lining can be supported by the underlying rock, and there is no need to line the section of the well below water.

Repair or construction of a masonry lining is only done in large-diameter wells (especially for thin and relatively unproductive aquifers), where the well-ring moulds required for constructing a lining in reinforced concrete would be too cumbersome and the quantities of materials required would be excessive. Sinking a masonry column (bricks or stones) is almost impossible, because it does not take the strains involved, and disintegrates.

### *3.2.2.3 Backfilling the excavation*

The space between the original excavation and the outside of the new lining must be filled with clay and rubble packing up to about 50 cm below ground level, where it is topped off with cement (see Chapter 8) to provide a seal.

It is very important to take special care over compaction of the packing, layer by layer. Water pumped during digging or development can be used to wet packing materials and obtain optimal compaction.

If this operation is not well done, the packing may compact naturally over the course of time (in the first rainy season, for example) and cause subsidence, creating cracks in the surface works, allowing infiltration of surface water.

## **3.3 Cleaning and deepening**

Cleaning a well is often necessary in cases where it is blocked by objects and sediment that have fallen in or, more generally, by progressive silting. It is necessary to regain sufficient water depth so that the well does not dry up, and so it recovers its production capacity.

Well-cleaning is a yearly operation carried out by the communities that use the well. It is easier to carry it out in the dry period. Emptying the well, if it is not too productive, may be carried out by hand using a bucket. In the case of higher-yielding wells, pulleys and animal traction or a dewatering pump may be required. Public wells are unfortunately often no-one's responsibility and are not cleaned, which is evidently not the case with private wells, even those that are narrow and very deep.

Deepening a well increases its flow in most cases, except when the base of the aquifer has already been reached. It becomes necessary when the static level falls with the passage of the time, or in wells in which sufficient water depth was not given enough attention or could not be achieved because of lack of materials and equipment at the time the well was constructed.



Deepening wells near the sea can quickly become problematic because of saline water below the unconfined freshwater aquifer (as was the case in Mogadishu). Redigging beyond this level should not take place, therefore, to avoid all risk of contamination of the well by salt water (see Chapter 3).

There are several options for deepening techniques, depending on the nature of the well:

- for masonry intakes, a column of pre-cast well rings of a smaller diameter than those already existing in the well can be sunk, or the masonry lining can be extended as redigging progresses (shallow depths);
- for reinforced concrete intake-lining sections, an independent intake column is sunk inside the old lining;
- for existing independent intakes, redigging is easy since it is sufficient to dig and add new well rings to deepen the intake column.

## 4 Disinfection

Disinfection is strongly recommended, both when rehabilitating a well and when digging a new one, and should always be done if the well is covered and equipped with a pump. There are various ways of proceeding using HTH (Box 7.3). Wells having significant occasional pollution, or those that are likely to be polluted, should be systematically disinfected.

### Box 7.3

#### Methods for disinfecting wells.

##### *Disinfection involving emptying the well*

- 1) Dilute 200 ml of 1% solution of active chlorine in a 10-litre plastic bucket (solution of 200 mg/l of chlorine), i.e. 3 g HTH (70% active chlorine) or 50 ml bleach (4% active chlorine) in 10 l of water.
- 2) Empty the well and brush its walls with the chlorine solution (take care with chlorine vapour), then wait for 30 min and let the well refill itself again.

##### *Disinfection without emptying the well*

- 1) Prepare a solution of 200 mg/l of chlorine, as above.
- 2) Brush the walls of the well above the water level.
- 3) Calculate the volume of water contained in the well:

$$V = 3.14 \cdot r^2 \cdot h$$

where V is the volume of the well (m<sup>3</sup>), r its radius (m), and h the height of water in the well (m).

- 4) Determine the quantity of chlorinated product to add to the water in the well to obtain a 100 mg/l chlorine solution: for each 1 000 l of water in the well, 100 mg/l of Cl = 140 mg HTH or 2.5 l of 4% bleach.
- 5) Make up the solution in 10-litre plastic buckets, with 250 g maximum of product per bucket (limit of solubility).
- 6) Pour the content of the buckets into the well, mix and wait 12 h, preventing access to the well.
- 7) Draw off water until it has only a slight chlorine smell.

##### *Notes*

- In zones where water is scarce, it is possible to treat the water in the well with only 50 mg/l of chlorine.
- If the well is equipped with a handpump, introduce the disinfecting solution into the well, then pump until chlorinated water is passing through the pump. Wait 12 hours, then pump until the water has only a slight chlorine smell.

## B FIELD EXAMPLES

<b>1</b>	<b>Implementation</b>	259	<b>2</b>	<b>Resources required</b>	262
1.1	Quantity estimates	259	2.1	Human resources	262
1.2	Time necessary for the construction of a well	260	2.2	Materials	262
1.3	Planning the construction of ten wells	261	2.3	Equipment	263

### 1 Implementation

#### 1.1 Quantity estimates

This estimate allows the unit cost of the works to be calculated, and the quantity of materials necessary to ensure the supply of the sites to be estimated. It is frequently drawn up in the form of tables (Tables 7.III to 7.V).

**Table 7.III: Quantity estimate for different works.**

Tasks	Quantities	Number of units	Unitary cost	Total cost	Cement		Reinforcement		Sand		Gravel	
					No. of bags/m	total	/m	total	/m	total	/m <sup>3</sup>	total
140 mm well lining												
Surface and bottom anchorage												
100 mm cutting ring												
100 mm independent intake												
Slab, apron, headwall												
Labour /m												
Others												
<b>TOTAL</b>												

**Table 7.IV: Materials for the construction of a 1.4 m diameter well with a 1 m diameter independent intake.**

	Cement		Gravel		Sand		Reinforcement	
	(m <sup>3</sup> )	(kg)	(m <sup>3</sup> )	(kg)	(m <sup>3</sup> )	(kg)	(m)	(kg)
Well lining per m 350 kg cement/m <sup>3</sup>	0.126 or 3.4 bags	144	0.4	800	0.2	340	50	20
Anchorage 1 surface + 1 bottom 350 kg cement/m <sup>3</sup>	0.25 or 6.7 bags	326	0.74	1 488	0.37	632	71	29
Intake per m 300 kg cement/m <sup>3</sup>	0.104 or 2.8 bags	138	0.276	552	0.138	235	34	14
Cutting ring 400 kg cement/m <sup>3</sup>	0.03 or 0.8 bag	42	0.084	168	0.042	71	31	12
Surface works (headwall, apron, drain)	0.62 or 17 bags	830	1.9	3 792	0.95	1 615	324	130
100 l drinking trough	0.028 or 0.7 bag	37	0.08	167	0.042	72	18	7

**Table 7.V: Materials for the construction of a 1.8 m diameter well with a 1.4 m diameter independent intake.**

	Cement		Gravel		Sand		Reinforcement	
	(m <sup>3</sup> )	(kg)	(m <sup>3</sup> )	(kg)	(m <sup>3</sup> )	(kg)	(m)	(kg)
Well lining per m 350 kg cement/m <sup>3</sup>	0.16 or 4.3 bags	209	0.48	955	0.24	406	64	26
Anchorage 1 surface + 1 bottom 350 kg cement/m <sup>3</sup>	0.33 or 9.1 bags	444	1.02	2 032	0.51	867	99	40
Intake per m 300 kg cement/m <sup>3</sup>	0.14 or 3.8 bags	189	0.38	754	0.19	320	46	18
Cutting ring 400 kg cement/m <sup>3</sup>	0.04 or 1.1 bags	53	0.107	213	0.053	91	41	16
Surface works (headwall, apron, drain)	0.62 or 17 bags	830	1.9	3 792	0.95	1 615	320	128

## 1.2 Time necessary for the construction of a well

The time required for constructing a well depends on the nature of the ground (stability and hardness), the participation of the community, and the depth of the well. An example is given in Table 7.VI.

**Table 7.VI: Time necessary for the construction of a 1.4 m diameter well, 15 m total depth, with an independent intake, by a team of trained well diggers.**

Operations to be carried out	Approximate period of time per operation
Installing and packing up the site	2 days
Excavation (1.6 m diameter)	
– stable and soft ground	1 m/day
– stable and semi-hard ground	0.8 m/day
Well lining (1.4 m diameter)	
– top-down	1 m/day
– bottom-up	2 m/day (2 superimposed passes)
Intake (1 m diameter)	
– rings cast at the surface	2 rings/day/mould during digging
– intake column cast at the bottom of the well	2 m/day
Well digging / intake sinking	
– soft ground	1 m/day
– semi-hard ground	0.6 m/day
Development and pumping tests	1 to 2 days
Surface works	4-5 days
Summary	
Installing the site	1 day
12 m excavation	12 days
Well lining, 12 m	6 days
Intake cast <i>in situ</i> , 4 m	2 days
3 m intake sinking	3 days
Development, pumping test	2 days
Surface works	4 days
Packing up the site	1 day
TOTAL	31 days

### 1.3 Planning the construction of ten wells

The project involved the construction of 10 wells of 1.4 m diameter, and 10 m average depth. Two teams of well diggers were trained, and the village was asked to participate, which is essential for the success of such a project (Table 7.VII).

**Table 7.VII: Planning for the construction of 10 1.4 m diameter wells, 10 m average depth.**

Month	Activities
1	Purchase of equipment (dewatering pump, tripods, moulds etc.) Recruitment of workers Contact with local partners Visit and choice of first sites Meeting and organisation of project with communities Classroom training for digging teams
2	Construction of well 1 with two teams under training Planning of meetings with villagers
3	Construction of well 2 with two teams to complete practical training Surveys and choice of 8 future sites Discussion with villagers for organisation of the work
4	Construction of wells 3 and 4 by two teams separately Continuation of community mobilisation programme (until end of programme)
5	Construction of wells 5 and 6 by two teams Starting of sites 7 and 8
6	End of construction of wells 7 and 8 Starting of wells 9 and 10 Evaluation of programme Possible proposal of new actions

## 2 Resources required

### 2.1 Human resources

It is necessary to plan for one or more teams of well diggers depending on the timescale for the programme. As an example, 10 wells of average depth 15 m can be done by one team of well diggers in 6 to 8 months; for anything beyond that, it is preferable to work with more teams. For efficiency, it is advisable to have one team specialised in working below water level and the other in simple digging and lining.

Each team has a leader, who is directed by a person responsible for the project or by a supervisor (Table 7.VIII). The communities must be involved in the work, for example by making up the labour force for the following tasks:

- creating access routes to the sites;
- collecting and sieving aggregates;
- supplying water for the site;
- digging and extracting cuttings, under the close supervision of the team;
- mixing cement, and other unskilled jobs.

**Table 7.VIII: Staff required for a well-construction programme.**

Personnel	Activities
<i>Management</i>	
1 manager	Technical assessment, planning, team management, relations with partners
1 logistics officer	Supplies to the sites, tracking of material and vehicles
<i>Digging and lining team (down to water level)</i>	
1 well digger	Site foreman
1 builder	Placing shuttering and reinforced concrete
4 labourers	Well digging, concrete mixing, winch operation
<i>Intake-section team</i>	
1 well digger/builder	Site foreman
4 labourers	Digging, sinking the intake column, concrete mixing, winch operation

### 2.2 Materials

The costs shown in Tables 7.IX and 7.X correspond to an average of all ACF well-building projects in Africa.

**Table 7.IX: Example of costs of a new well.**

Diameter (cm)	Depth (m)	Cement (kg) (US\$ 250/t)	Aggregates (m <sup>3</sup> ) (US\$ 10/m <sup>3</sup> )	8 mm reinforcement (m) (US\$ 0.7/m)	Cost (US\$)
140	5	2 610	8.7	850	1 335
	10	3 330	11.7	1 100	1 720
	15	4 050	14.7	1 350	2 105
	20	4 770	17.7	1 600	2 490
	25	5 490	20.7	1 850	2 875
180	5	3 310	11.1	1 010	1 645
	10	4 360	15.0	1 330	2 170
	15	5 410	18.6	1 650	2 690
	20	6 450	22.5	1 970	3 220
	25	7 500	26.1	2 290	3 740

**Table 7.X: Example of the rehabilitation cost of a well including a 5 m intake and surface works.**

Diameter (cm)	Materials	Quantities necessary	Cost (US\$)
140	Cement	1 890 kg	950
	Aggregates	6 m <sup>3</sup>	
	Reinforcement 8 mm 600 m		
180	Cement	2 270 kg	1 125
	Aggregates	7.5 m <sup>3</sup>	
	Reinforcement 8 mm 690 m		

## 2.3 Equipment

Indicative lists of the tools and equipment necessary for two teams of well diggers working simultaneously are shown in Table 7.XI.

**Table 7.XI: Average cost of tools and equipment for two teams of well diggers.**

	Quantities	Price (US\$)
Heavy equipment		
Dewatering kit <sup>1</sup>		
– pneumatic dewatering pump and compressor	1	10 000
– or electric dewatering pump and generator	1	5 000
Water-level sensor (dipper)	1	700
Shuttering set		
– sliding shuttering	2	1 600
– mould for intake rings <sup>2</sup>	2	3 000
– mould for headwall	1	600
– mould for cutting ring	1	800
Tripod and manual winch (8/10 mm cable, 1.5 t) <sup>3</sup>	2	4 000
Derrick and well-digging grab bucket (for deep wells and special works)	1	14 000
Light tools and equipment		
– tools (pickaxes, shovels, trowels, chisels, builder's buckets, wheelbarrows)	10	
– 3 kg sledge hammer, hammer, saw	5	
– bolt cutter for concrete reinforcement bars	2	
– set of spanners for assembling the moulds	5	
– wire brush	5	
– safety rope (25 mm)	2	
– sieves: 5, 10 and 20 mm	2	
– water drums (200 l)	4	
– plumb line, shock-resistant spirit level, double measuring tape, builder's ruler	5	
– helmets	10	
– gloves	20	
– safety harness	4	
– first aid kit	2	
TOTAL		39 700

1. Pneumatic dewatering pumps have numerous advantages: simplicity, sturdiness, ability to lift muddy water, ease of use (light and not bulky), possible use of a pneumatic hammer vibrating rods etc.

2. A complete set of ring moulds includes the internal and external moulds, a cover for the upper lip, and two covers for the lower lip (it is possible to cast two rings a day).

3. Pyramid tripod composed of tubes of 60 or 80 mm diameter, to which a pulley is hitched (free height 2 m). A manual winch is usually located at the base of the frame to lift the cuttings to the surface. It can also be fixed directly onto the headwall.

# Boreholes

## A BOREHOLE DRILLING

<b>1</b>	<b>Drilling for water</b>	266	5.3.3	<i>Removal of a drill pipe</i>	291
1.1	Exploration	266	5.3.4	<i>Common problems</i>	292
1.2	Exploitation	266	5.3.5	<i>Analysis of cuttings and signs of water</i>	293
1.3	Examples of borehole costs	267	5.4	DTH percussion drilling	293
<b>2</b>	<b>Drilling techniques</b>	267	5.4.1	<i>Adjustment and lubrication of the DTH hammer</i>	293
2.1	Rotary drilling	267	5.4.2	<i>Installation of the hammer</i>	294
2.2	Down-the-hole hammer drilling	268	5.4.3	<i>Drilling process</i>	294
2.3	Borehole parameters	269	5.4.3.1	Starting the hole	295
2.3.1	<i>Rotation, pressure and lifting force</i>	270	5.4.3.2	Advance	295
2.3.2	<i>Drilling fluids</i>	271	5.4.3.3	Addition and removal of drill pipes	295
2.3.3	<i>Rotary drilling mud</i>	271	5.4.4	<i>Difficulties and possible solutions</i>	296
2.3.4	<i>Air in DTH drilling</i>	272	5.4.5	<i>Analysis of cuttings, signs of water and flow calculation</i>	296
2.3.5	<i>Drilling guidelines</i>	273	<b>6</b>	<b>Borehole equipping</b>	297
<b>3</b>	<b>Lightweight drilling rigs</b>	274	6.1	Permanent casing	297
3.1	ACF-PAT 201 kit	274	6.1.1	<i>Choice of casing and screen</i>	297
3.2	ACF-PAT 301 kit	275	6.1.2	<i>Casing fitting</i>	298
3.2.1	<i>Technical characteristics</i>	276	6.2	Gravel pack and grouting	300
3.2.2	<i>Working principle</i>	277	6.2.1	<i>Gravel pack</i>	300
3.3	ACF-PAT 401 PTO kit	279	6.2.2	<i>Grouting</i>	301
3.4	Other lightweight drilling rigs	279	6.2.2.1	Preparation of the grout	301
<b>4</b>	<b>Borehole design</b>	282	6.2.2.2	Placing the grout	301
4.1	Choice of casing	282	<b>7</b>	<b>Development</b>	301
4.2	Pre-casing	284	7.1	Borehole cleaning	302
4.3	Usual configurations	284	7.2	Development processes	302
<b>5</b>	<b>Borehole drilling</b>	286	7.2.1	<i>Air-lift development</i>	302
5.1	Choice of technique	286	7.2.2	<i>Other development techniques</i>	304
5.2	Site preparation	286	7.2.3	<i>Pumping</i>	305
5.2.1	<i>Installation</i>	286	7.3	Instantaneous flow	305
5.2.2	<i>Mud pits</i>	287	<b>8</b>	<b>Monitoring and borehole report</b>	305
5.2.3	<i>Preparation of drilling mud</i>	289	<b>9</b>	<b>Surface works</b>	306
5.2.4	<i>Removal of cuttings in the DTH technique</i>	290			
5.3	Rotary drilling	290			
5.3.1	<i>Starting</i>	290			
5.3.2	<i>Advance: adding a drill pipe</i>	290			

This chapter is a practical guide to standard drilling techniques and implementing drilling programmes in places with a hydrogeological potential that are accessible with light drilling machinery. The performance of this type of machinery makes it very versatile, and suitable for difficult contexts of humanitarian operations. Three machines have been developed by ACF in collaboration with a Thai manufacturer (PAT, see Annex 11A):

- ACF-PAT 201 is a light and fairly inexpensive machine, but limited to unconsolidated sedimentary formations;
- ACF-PAT 301 is used to drill boreholes in consolidated or unconsolidated formations;
- ACF-PAT 401 is a more powerful machine than the ACF-PAT 301 with simpler implementation logistics.

Over the past few years, PAT have continued to improve these models on their own.

## 1 Drilling for water

### 1.1 Exploration

In a difficult hydrogeological context (for example, with little or no alluvial aquifer, or in the presence of multi-layered aquifers with some saline water levels), it is advisable to drill prospecting boreholes. These indicate the presence and quality of groundwater and the nature of the aquifer, and allow calibration of the readings taken during geophysical exploration. Generally such boreholes are narrow, with small-diameter casing (43 to 100 mm). After the prospecting phase they are either maintained as piezometers, or blocked up and abandoned. Simple pumping tests verify the presence of water.

### 1.2 Exploitation

The work carried out enables an underground aquifer to be reached and exploited, even if it is situated at great depth (more than a hundred metres). In ACF's programmes, most boreholes are equipped with handpumps to provide drinking water to rural and/or displaced populations.

In some countries, national regulations impose boreholes rather than wells (for the preservation of groundwater quality). In addition, boreholes are particularly appropriate in the following cases:

- pollution of shallow aquifers (poor bacteriological or physicochemical water quality);
- digging wells is too long or costly to meet the needs of the populations (displaced people's camps);
- geological context which does not allow well-digging, due to formations that are too hard or too deep;
- impossible to maintain an emergency water treatment station (not taken on by the community);
- boreholes which allow rapid response to urgent needs.

However, a certain number of technical, financial and logistical factors must be taken into account before beginning a borehole programme, in order to ensure its feasibility:

- the hydrogeological potential of the zone must be assessed by a preliminary study to determine the type of drilling rig required, the foreseeable flows and the chances of success. These may be low, so this must be provided for in the action plan;
- the choice of pump to be installed (manual or electric submersible), depending on the hydrogeological potential and the required flow;
- the possibility of finding a drilling rig in working order locally, or the need to import it (air, sea and/or land transport);
- local technical skills (driller, mechanic, geologist). It is possible to train a driller in drilling techniques, but can it take some time at the beginning of the programme. Normally the use of an ACF-PAT 201 (see Section 3) does not present problems;
- time required for import and starting (1 month minimum);
- local means of transport from site to site.



### 1.3 Examples of borehole costs

Since 1991, ACF has drilled more than 4 000 exploitation boreholes equipped with hand-pumps in Asia (Cambodia, Myanmar) and Africa (Liberia, Sierra Leone, Ivory Coast, Guinea, Sudan, Sudan, Uganda, Mozambique, Angola, Ethiopia, Honduras, Guatemala, Chad), using ACF-PAT 201, 301, 301T and 401 rigs.

In Cambodia, the cost of a 30-m borehole equipped with a handpump (suction pump type VN6) is USD 300 (equipment only).

In Guinea, the cost of an equipped borehole with an average depth of 40 m, using a Kardia handpump (USD 2 500), amounts to USD 4 000 (equipment).

A programme of 30 boreholes at an average depth of 40 m with an 80% success rate, taking into account the depreciation of one ACF-PAT 301 rig, corresponds to a cost of USD 7 000 per borehole.

As a comparison, a borehole drilled by a contractor, without a pump, can be costed as follows:

- in Haïti, 35 m deep, 8” diameter: USD 8 500;
- in Mali, 120 m deep, 6” diameter: USD 12 000;
- in Angola, a programme of at least 10 boreholes at a depth of 60 m: USD 8 000 with cable-tool drilling rig, and USD 13 000 with a rotary drilling rig;
- in Southern Sudan / Uganda, at a depth of 50 m and with a 6” diameter: USD 12 000-15 000.

## 2 Drilling techniques

Several techniques of drilling for water have been developed to suit the type of borehole required and the geological context.

Cable-tool drilling is the oldest technique. It is conceptually simple, and is especially useful in coarse sedimentary formations (gravels, pebbles), which are excellent reservoirs. This technique is not covered in detail in this book. Material removed is lifted to the surface mechanically, using a cylindrical bailer or scoop (Beneto-type machines).

Rotary and ‘down-the-hole’ (DTH) hammer techniques are the most widely used and are the most suitable in drilling for water. Certain rotary drills are very large and can drill down to several hundred metres.

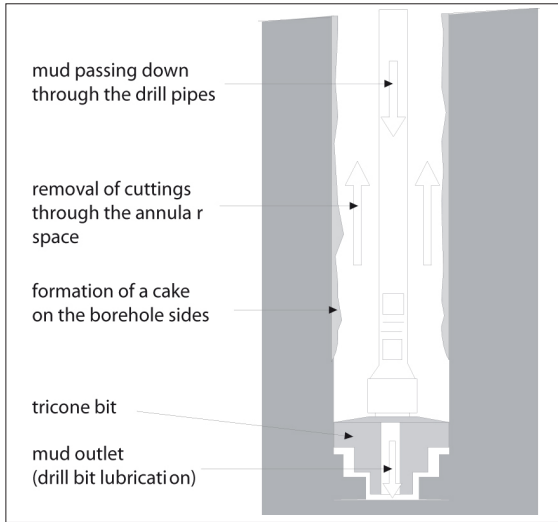
For the lightweight machinery used by ACF, the ACF-PAT 201 model comes only in a rotary version, whereas the ACF-PAT 301 and 401 are DTH models (combined rotary and percussion).

### 2.1 Rotary drilling

The rotary technique (Figure 8.1) is used only in unconsolidated sedimentary formations with lightweight machinery (high-power rotary machines such as that used for oil drilling can however work in hard formations).

A rotary drill bit, known as a tricone bit, is driven from surface level via drill pipes. The drill bit works by abrasion of the ground, without percussion, using only rotation and pressure. This is provided by the power of the machine but, above all, by the weight of the drill pipes above the drill bit: when drilling large boreholes, weighted drill pipes, are used for this purpose.

At the bottom of the hole, the drill bit cuts away pieces of ground (cuttings). The circulation of a liquid, the borehole drilling mud, brings the cuttings up to the surface. The drilling mud is injected down the centre of the hollow drill pipes (or drill string) to the level of the drill bit and returns to the surface via the annular space between the drill string and the sides of the hole. While it is rising, the drilling mud covers the borehole sides and stabilises them (cake). This drilling mud is made up of water, a clay (bentonite) or a polymer, usually polycol. It moves in a closed circuit: when it arrives at the surface, it is channelled into a series of pits which allow the cuttings to settle, and it is then re-pumped and injected under pressure down the drill string.



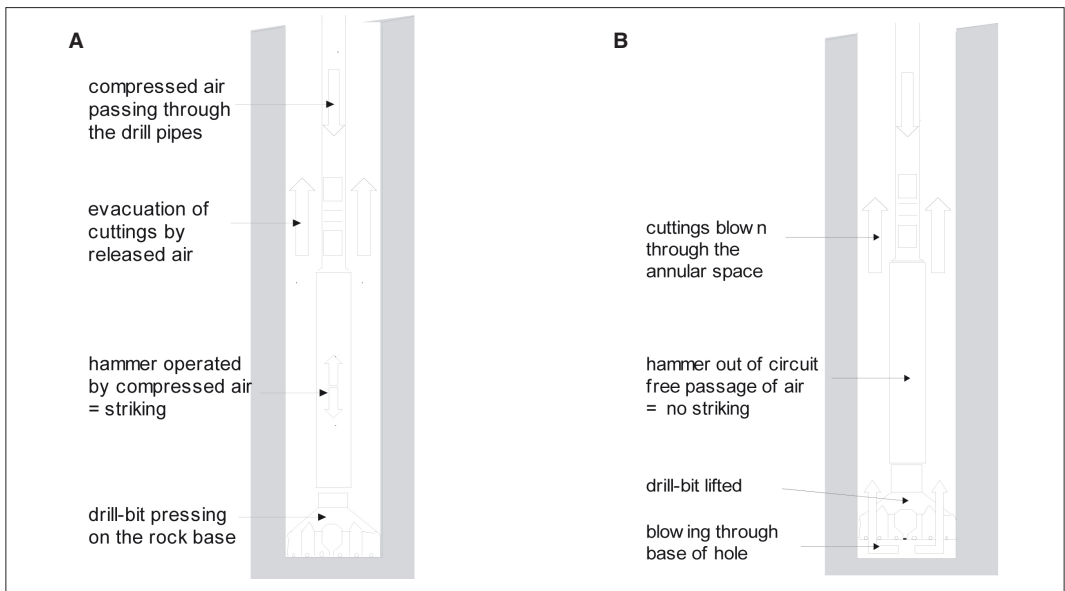
**Figure 8.1: Working principle of rotary drilling.**

## 2.2 Down-the-hole hammer drilling

This technique allows drilling in hard formations.

A cutter with tungsten carbide buttons, fixed directly onto a pneumatic hammer (DTH), is rotated with a hammer action to break and grind the rocks. The hammer works like a pneumatic road drill, using compressed air delivered by a compressor. The air flow raises the cuttings to the surface.

There are two phases, percussion and blowing (Figure 8.2).



**Figure 8.2: Working principle of DTH hammer drilling.**

**A: percussion:** the compressed air operates the piston of the hammer, which strikes the drill bit pressed on the rock; part of the air then escapes into the annular space, carrying the cuttings with it.

**B: blowing, or removal of the cuttings:** the drill bit is withdrawn slightly, so that all the air flow passes around the hammer without operating it, and then escapes into the annular space.

## 2.3 Borehole parameters

The parameters that control drilling progress depend on the technique used (rotary or DTH): rotation and pressure on the drill bit (Box 8.1), and rising speed and pressure of the drilling mud or air – see box 8.2. These factors have varying influences on the rotary or DTH techniques, and it is essential to control them in order to achieve good working conditions: smooth progress, constant cutting removal, and stabilisation of the borehole sides (Figure 8.3).

In rotary drilling, for a given rotational speed, the essential parameter for progress of a borehole is the weight acting on the drill bit. Rotational speed is kept as regular as possible, depending on the drill-bit diameter and the nature of the formation. Generally, rotational speed will be lower for hard formations.

In DTH drilling, on the other hand, the determining factor is not weight, but the percussive action of the drill bit on the rock caused by the pressure of the compressed air acting on the hammer. However, insufficient weight can induce blind striking, which can cause serious damage to the hammer and drill bit. Too much weight, on the other hand, damages the drill-bit buttons. In practice, and with experience, the pressure on the drill bit is controlled by ear – a clear striking sound means that the hammer is working correctly – so as to obtain a regular rotational speed and to prevent excessive vibration.

### Box 8.1

#### Calculation of pressure and rotational speed\*.

##### *Drill-bit loading*

In rotary mode, the theoretical minimum pressure on a tricone bit is about 450 kg per inch of bit diameter and about 225 kg per inch for a three-bladed bit, i.e. a minimum downward force of 1 350 kg for a 6" three-bladed bit, and 2 700 kg for a tricone bit of the same size.

For a DTH hammer, the usual pressure is 100 to 200 kg per inch of drill-bit diameter, i.e. between 600 and 1 200 kg for a 6" drill bit.

##### *Rotational speed*

The calculated speed is that of a point situated at the periphery of the drill bit (tangential speed), that is, the time the point takes to cover a given distance.

The following formula is used to calculate the number of revolutions per minute:

$$\text{revolutions per minute (rpm)} = \frac{\text{tangential speed (m/min)}}{\pi \cdot d(\text{m})}$$

where  $\pi = 3.14$  and  $d$  is the drill bit diameter (m).

In rotary mode, the minimum tangential speed must be 60 m/min, and for a DTH hammer it must be 10 m/min, that is, for a 150 mm drill bit:

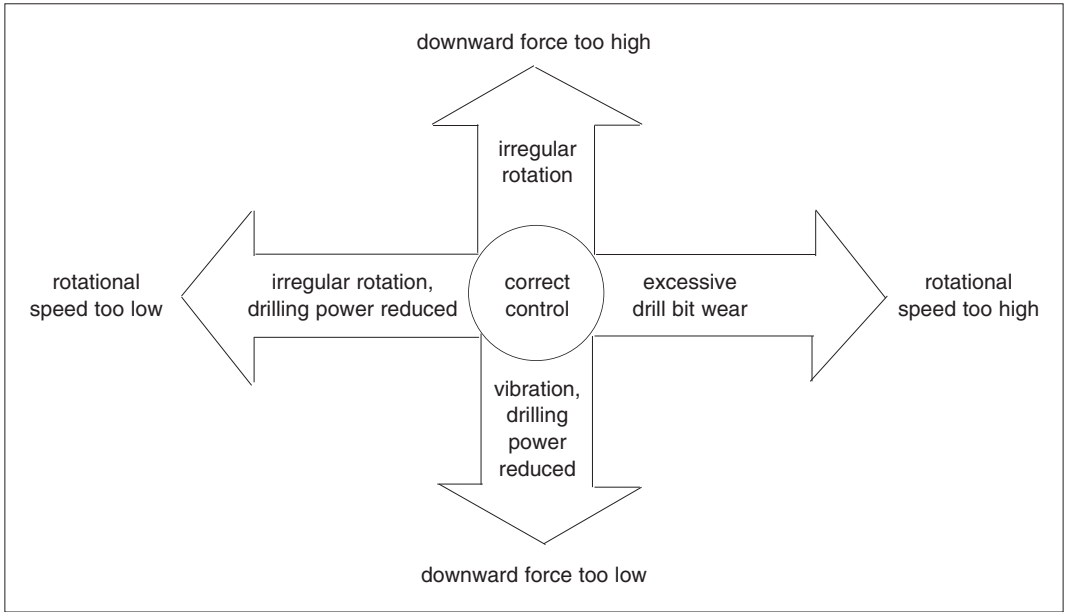
- in rotary mode, 127 rpm;
- in DTH mode, 21 rpm.

##### *Torque*

For rotary and DTH drilling, the minimum advised torque is 2 000 N-m per inch of diameter of drill bit used.

A safety factor of 1.33 is applied; that is, for a 6" drill bit, a torque of 16 kN-m.

\* Raymond Rowles, *Drilling for Water, a Practical Manual*, Avebury/Cranfield University, 1995.



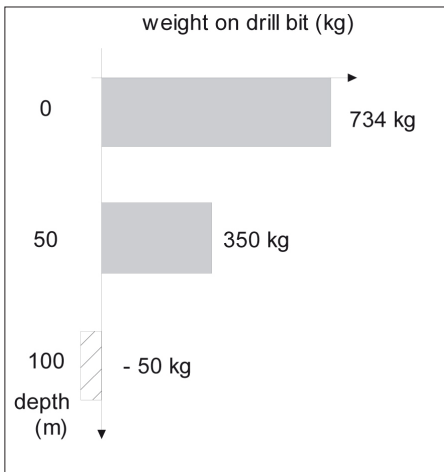
**Figure 8.3: Control of downward force and rotation.**

### 2.3.1 ROTATION, PRESSURE AND LIFTING FORCE

The rotation is transmitted mechanically (motor, gearbox, clutch or kelly on large machines) to the drill string by the drive head. It is calculated by simply counting the number of revolutions per minute.

The torque of the machine is expressed in Newton-metre and plays a fundamental role in rotary rigs working in hard sedimentary formations, and at great depths. It plays a secondary role in lightweight rigs, since the rotary technique has a limited application in hard formations. The values expressed are well within the recommended ranges.

The pressure depends on the power of the rig itself and the weight of the drill string above the drill bit. Consequently, the deeper the borehole, the heavier the weight on the drill bit induced by the weight of the drill pipes. When the borehole is started, the pressure on the drill bit is therefore sometimes low, particularly with lightweight rigs. On the other hand, at great depths, the drill string must be supported so as not to apply excessive pressure on the drill bit (Figure 8.4). The pressure to be applied on a tricone bit (rotary) is much higher than that applied on a DTH bit, but rotational speed is reduced (Box 8.1).



**Figure 8.4: Downward force applied as a function of depth and weight of drill pipes.**

The drill bit is 150 mm diameter, and the downward force on the hammer is about 800 kg. The weight of standard drill pipes is about 7 – 8 kg/m. The downward force of the drilling rig (in addition to the drill string) has to be increased at the start of drilling; after a certain depth is reached, the drill string may have to be supported as the weight of drill pipes increases.

The lifting force is provided by the machine power. Its value is given by the manufacturer and is generally expressed in tonnes. Obviously, it lifts the drill string, but can also be used to free the drill bit if the borehole sides collapse.

### 2.3.2 DRILLING FLUIDS

Drilling fluids are either lubricated air (with or without foam) for use with DTH hammers, or water incorporating a given amount of drilling mud for rotary drilling. These fluids play several roles, summarised in Table 8.I.

**Table 8.I: Drilling fluids.**

Drilling technique	Type of fluid	Role of the fluid
Rotary	Drilling mud: – water – bentonite – polycol	Cuttings removal Binding and stabilising the sides (cake formation) Lubrication, cooling of the drill string and drill bit
DTH	Lubricated compressed air Lubricated compressed air + foam (foaming agent)	Operating the hammer Improved cuttings removal (blowing) Lubrication of the hole

DTH drilling is often done without foam but this practice must be avoided. The use of foam really improves the efficiency of drilling (cuttings removal) and strongly decreases the risk of getting the hammer stuck.

Rotary drilling can be carried out using only air, without drilling mud. This technique allows quicker drilling and can sometimes get to a good depth in dry and stable formations. This allows the absence of water to be established without having to install any casing. If water is reached however, drilling becomes more difficult, with increased risk of collapse, and here mud drilling must be used.

This technique is also often applied over the first few metres of the borehole (10-20 m), as it avoids the need for drilling mud if drilling is to be continued with a DTH hammer (bedrock near the surface). However, if the surface layers are not stabilised by the cake, the risk of the sides collapsing is higher (erosion by the air flow). Furthermore, the wet cuttings tend to agglomerate and, being too heavy to rise to the surface, they remain in suspension in the borehole until they form a plug in the annular space.

### 2.3.3 ROTARY DRILLING MUD

Drilling mud plays an essential role in the drilling process: it brings the cuttings to the surface, stabilises the sides, and lubricates the drill bit. The intrinsic characteristics of drilling mud (density, viscosity) are regularly checked and modified during the drilling process, thinning or thickening as necessary:

- density influences the transport of the cuttings to the surface and the stabilisation of the bore hole sides. Heavy drilling mud has better transport properties, and the cuttings float better;
- low temperature cools the drill bit;
- viscosity influences the lubrication of the drill bit as well as the transport of the cuttings (thrusting effect).

*Note.* – Polycol is a polymer which gives a spiral movement when circulating in the hole, and this improves the rise of the cuttings.

Hydrodynamic parameters (flow, pressure) also have an effect:

- the flow of the pump influences the circulation rate of the drilling mud (rate of rise), and directly influences the removal of the cuttings (Box 8.2). For the cuttings to pass within the annular space, it is necessary to maintain a minimum speed suitable to the density of the fluid. For constant flow, the velocity of the fluid (m/s) decreases as the annular space increases;
- the pressure of the drilling mud offsets head-losses in the drill string, since the circuit is balanced (open U circuit at atmospheric pressure at the surface). In theory, no pressure is necessary to ensure the return of the drilling mud. Nevertheless, high pressure is very useful in the event of a blockage in the annular space.

### 2.3.4 AIR IN DTH DRILLING

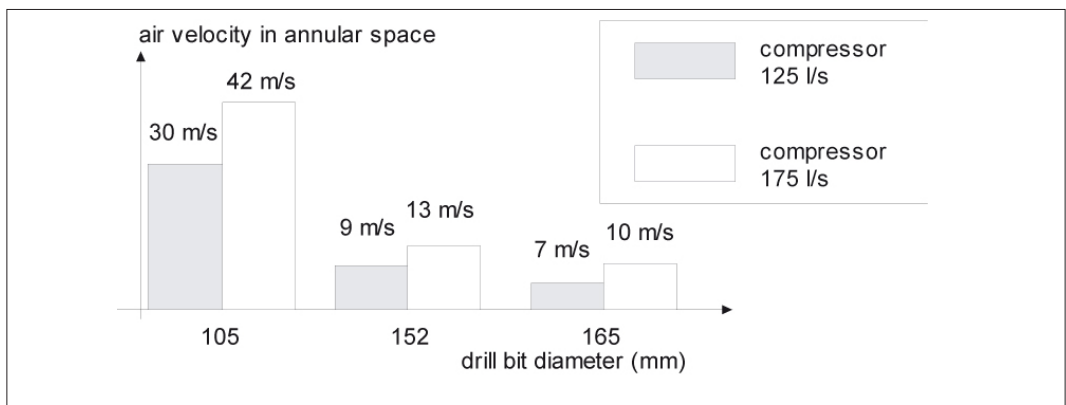
Air has two different functions: to operate the hammer, and to bring the cuttings to the surface. Therefore, several essential parameters must be checked.

The minimum air supply necessary to operate the hammer (several litres per second) and also to provide air flow high enough to carry medium-size cuttings (several millimetres – Figure 8.5 and Table 8.II) must be determined. The addition of foam to create an air/foam emulsion increases the transport capacity, and the emulsion can carry cuttings with diameters of about one centimetre, for low rise rates of about 10 to 15 m/s. By lubricating the rocky sides of the hole, the foam decreases the risk of getting the hammer stuck and it must be systematically used in deep boreholes.

The pressure of the air injected has a direct effect on the ability of the hammer to crush the rock, and therefore on the drilling advance speed (Table 8.III). The lubrication of the air must be permanent, because it lubricates the hammer piston liner.

**Table 8.II: Air velocity necessary in DTH drilling, without the addition of foam, to bring spherical cuttings of a specific gravity of 2.8 to the surface.**

Cuttings diameter (mm)	Air velocity (m/s)
0.1	1
0.5	5
1	8
5	18
10	24



**Figure 8.5: Air velocity as a function of compressor flow and drill bit diameter.**

**Table 8.III: Drill advance speed at a site in northern Uganda in gneiss formations with an ACF-PAT 301 rig equipped with a 150 mm drill bit and a 8 or 12 bar compressor.**

Compressor	8 bars – 175 l/s				12 bars – 125 l/s	
Borehole number	10 825	10 823	10 829	10 828	10 832	10 836
Average time per 2 m drill pipe (min)	44	52	69	23	18	36

**Box 8.2**

Calculation of rise rate of the fluid.

To calculate the fluid velocity in the annular space, pump flow is divided by passage cross-sectional area, e.g., for a flow of 19 l/s, a 150 mm borehole, and 76 mm drill pipes:

$$\frac{Q}{\pi d^2/4 - \pi D^2/4} = V$$

$$\frac{0.019}{3.14 \times (0.15)^2/4 - 3.14 \times (0.076)^2/4} = 1.4 \text{ m/s}$$

where d is the external diameter of the drill pipes (m), D the diameter of the borehole (m), Q the flow (m<sup>3</sup>/s) and V the speed (m/s).

Raymond Bowles (1995) gives minimum annular flow speeds required for various fluids: 0.6 m/s for water, 0.35 m/s for drilling mud (water + bentonite) and 15 m/s for pure air (without foam).

He also gives maximum permissible flow speeds: 1.5 m/s for water and 25 m/s for air. At speeds above this, erosion of the sides of the borehole may occur, which could lead to loss of the borehole.

**2.3.5 DRILLING GUIDELINES**

The values of these parameters are merely indicative (Table 8.IV) and correspond to recommendations for standard drilling rigs; they are therefore much larger than the values used with light-weight rigs.

**Table 8.IV: Drilling parameters (guidelines).**

	Rotary	DTH
Pressure on the drill bit	Per inch of drill bit	
– three-bladed bit	225 kg	
– tricone bit	450 kg	
– DTH-hammer bit		100-200 kg
Rotation	10-150 rpm	25-50 rpm
Torque	2 000 N-m per inch of drill bit Coefficient of 1.33 in addition to be applied	
Fluid flow speed	Drilling mud	Air (pure)
– minimum	0.35 m/s	15 m/s
– maximum	1.5 m/s	25 m/s
Minimum pressure of the fluid (in bars) for a 4" borehole	Drilling mud 1 bar Depends on diameter	Air 12 bars Depends on diameter

The characteristics of the ACF-PAT rigs do not meet the specifications given in Table 8.IV (pressure, torque) in rotary technique, which simply means that these drills have very precise limitations in application, and that it is necessary to adapt the technique to the formations encountered. A rotary technique with light drilling machinery is not applicable in hard formations, where DTH hammers are required.

### 3 Lightweight drilling rigs

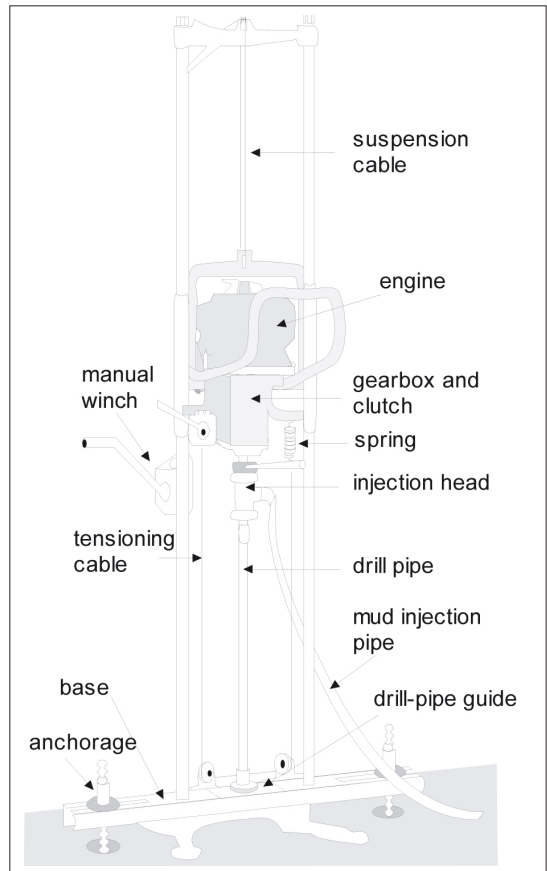
The three drilling rigs described below have been developed by the firm PAT, based in Thailand. ACF has adapted these machines (originally designed for working in Asian contexts, i.e. sedimentary formations) to the context of African bedrock zones. Three drilling kits have been manufactured: ACF-PAT201, ACF-PAT 301 and ACF-PAT 401 PTO.

#### 3.1 ACF-PAT 201 kit

This very simple machine is a rotary rig composed of a frame and a rotary motor (Figure 8.6 and Annex 11A), a mud pump, and a small light compressor for borehole development.

The main advantages of this machine come from its light and mobile structure, which enables drilling to be carried out in isolated zones without needing to transport a complete site kit, which is very heavy\*. A standard pick-up is enough to transport it from site to site with the rest of the equipment. The whole kit can be transported by light aircraft, which is an asset in many inaccessible places with humanitarian crises. The very simple operation of this type of machine allows local teams to become technically independent very quickly.

Boreholes are equipped with hand-pumps, or sometimes 4" submersible pumps, depending on demand and available flow. Maximum exploration depth is about 45-60 m in all unconsolidated formations (sand, clay, and fine gravel). For depths greater than 60 m, the machine is limited by the configuration of its drill string in its standard version (60 m), by its manual lifting winch, and by the capacity of the mud pump. However, it is possible to use some optional equipment which allows drilling to a depth of 80 m.



**Figure 8.6: The ACF-PAT 201 drilling rig.**

\* Net weight of the complete site kit: 787 kg. Gross weight of the complete kit: 949 kg. Packed volume (8 boxes): 5.5 m<sup>3</sup>.



**Table 8.V: Characteristics of the ACF-PAT 201 kit (1998 version).**

Frame	Total height of crossbar: 2.9 m Manual lifting winch equipped with 5 pulleys (cable length 11.5 m, ratio 4:1) Installation chassis for a pick-up
Drive head	Engine: Honda GXV-140 petrol 5 HP, 3 600 rpm + gearbox + clutch Rotational speed 80-120 rpm
Drill pipe, standard drill bits and accessories	Length 1.5 m x 40 units –thread 2" 3/8 API reg. Exterior dia. of the drill pipes 54 mm – 4 mm pitch – weight 16 kg – total 45 m Three-bladed bits: 1 pcs 8" (103 mm) – 2 pcs 6" 1/2 (165 mm) – 2 pcs 3" 1/2 (89 mm) 1 three-bladed bit 165 mm for clay Adaptor: 2 pcs 201 A – 2" 3/8 API female 2 pcs 201 A – 3"1/2 API female Complete toolbox
Pressure torque lifting force	Manual winch 196 Nm Manual winch max. 400 kg
Mud pump	Pump: Taki – TGH max. 42 m – max. flow 19 l/s Engine: Honda GX 390 – 13 HP petrol Suction pipe 3" x 4 m Delivery pipe 1"1/2 x 6 m
Development compressor	Engine: Honda GX 390 – 13 HP – 3 600 rpm Compressor: FUSHENG model TA 80 – 3 compression cylinders – max. flow 7.5 l/s – max. pressure 100 m 80 m air hose on reel

The drilling power is given by the weight of the drill pipes above the drill bit, and is limited by the surface formation encountered (a cap of laterite, for example).

Its configuration and cost also make it very suitable for exploration to optimise a well-digging programme, thus avoiding expensive dry wells.

Numerous borehole programmes have been carried out by humanitarian organisations with this machine in South-East Asia, in Africa by ACF, in very isolated areas such as Southern Sudan, Liberia, Sierra Leone, Mozambique or Angola.

The speed of implementation depends essentially on the geological context and the conditions of access to the site. In a very favourable context (shallow water table), it is possible to drill one borehole per day. However, during a drilling programme, the time invested in transport, installation and packing up, choice of site, construction of boreholes, and maintenance must also be taken into account. Normally, in a difficult context, it is possible to drill one borehole per week.

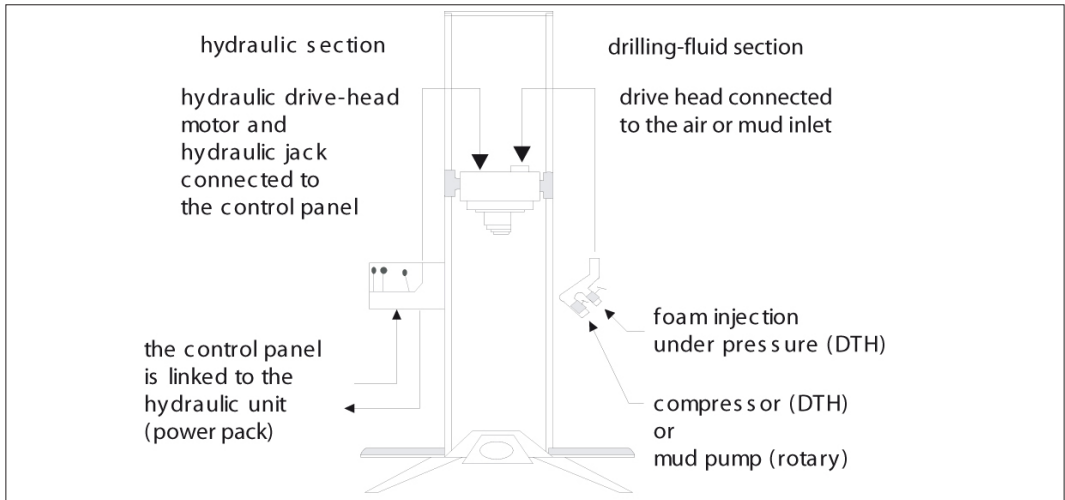
The technical specifications of the ACF-PAT 201 kit are given in Table 8.V.

### 3.2 ACF-PAT 301 kit

The ACF-PAT 301 rig (Figure 8.7 & Annex 11A) is a combined rotary and percussion (DTH) drill, developed to drill in all types of hard sedimentary formations. ACF has adapted it to much harder formations, such as bedrock.

In rotary mode, it can drill deeper than the ACF-PAT 201 in fairly hard formations. It can therefore be limited to rotary mode. Its investigation depth is about 100 m for 6" and up to 150 m for 4" holes (ACF, Myanmar, 1996). In percussion mode, it can be used for boreholes of 40 to 60 m depth and 150 mm diameter in rocks and weathered formations.

This rig has most of the advantages of the lighter ACF-PAT 201, but much wider application. It is available as an air-transportable kit, and can be used for emergencies; its technology is relatively



**Figure 8.7: The ACF-PAT 301 drilling rig – working principle.**

simple and accessible for a trained local team. The assembly can be fixed on a pick-up or a flat-bed truck, or mounted directly on the ground. The frame can also be towed (mounted on two wheels – not advisable in rough conditions).

The ACF kit includes a chassis adapted to the dimensions of the bed of a Land Cruiser pick-up, which allows the machine to be fixed. It is important to fit jacks to the back of the pick-up or truck in order to be able to drill vertically and stabilise the vehicle during the drilling process.

Installation of this rig directly on the ground is the simplest technique, and allows a very quick start while waiting for a possible mounting on a vehicle.

Since 2002, PAT has developed a new concept of the 301, the PAT 301T, by installing the rig on a trailer. The PAT 301T is easier to install and more stable (and efficient) than the standard 301. As the trailer is independent of the vehicle, the rig doesn't prevent use of the vehicle during drilling as with the 401, giving operational flexibility.

**Table 8.VI: Site configuration depending on intervention contexts.**

Context	Characteristics	Site configuration
Borehole in camps, in an urban area or near the base	Fairly short distances between drilling locations	Machine on the ground or on a pick-up Towed compressor
Village borehole in a scattered zone (Sahel type)	Long distances, Very bad roads	Machine and compressor on a truck
Only rotary drilling		Machine on pick-up, machine on ground

### 3.2.1 TECHNICAL CHARACTERISTICS

The machine is composed of a frame, a drive head and hydraulic power unit, a pumping unit (mud pump), a small compressor (for development), and an air compressor to work with a DTH hammer. The technical specifications of the standard kit are given in Table 8.VII and 8.VIII. The applications of the PAT in rotary mode are below the advised standards: the use of the tricone bit, which requires a high pressure, is not very advisable. In practice, for fairly hard sedimentary formations, the DTH is more suitable, because it needs much less pressure. The air-rise rate is limited by the flow of the compressor used and the drilling diameters.

**Table 8.VII: Characteristics of the ACF-PAT 301 kit.**

Frame	Height: 3.15 m, with crossbar of 2.25 m of useful run, equipped with 2 wheels Weight 320 kg – drilling table dia. 200 mm
Drive head	Hydraulic motor Rotational speed 0-40 rpm – torque 136.5 kgf.m (1 320 Nm)
Drill pipe & standard drill bits	Length of the drill pipes 2 m x 50 units – exterior dia. 76 mm Thickness 4 mm – weight 16 kg Screw thread: 2”3/8 API reg. Three-bladed bits: 2 pcs 9” (228 mm) – 1 pcs 8” (203 mm) – 2 pcs 6”1/2 (165 mm) – 2 pcs 4” (101 mm) 1 three-bladed bit 61/2” for clay 3 adaptors 2”3/8 x 2”3/8 API reg. (female – female) 2 adaptors 2”3/8 x 3”1/2 API reg. (female – female) Hammer: Stenuick Challenger 5 – drill bits: 1 x 150 mm – 2 x 165 mm
Hydraulic unit	Engine: Honda 13 HP petrol, 3 600 rpm (portable chassis) Hydraulic oil reservoir 60 l Hydraulic pump 250 bars
Feed system	Drive head raised and lowered by a hydraulic cylinder and heavy-duty transmission chain Lifting capacity: 1 590 kg, max. speed: 15 m/min
Mud pump R Standard	Engine: Honda GX 390 – 13 HP – 3 600 rpm – petrol (or Yanmar 10 HP diesel, hand-start, 3 600 rpm, air-cooled) Pump: Taki 65-33/2 (168 kg), 1 000 l/min at 30 m head, 600 l/min at 50 m head, pressure max. 4 bar
Screw compressor for drilling	ATLAS COPCO XAH 12 bar -175 l/s* Weight 1.5 T – 2 wheels – Diesel engine: DEUTZ 115 HP
Development compressor	Engine: GX 390 HONDA 13 HP – 3 600 rpm (Yanmar 10 HP diesel, hand-start, 3 600 rpm, air-cooled) Compressor: FUSHENG TA 80 (3 cylinders) – max. pressure 10 bar– max. flow 125 l/s 1/2” x 5 m flexible rubber hose with connections from reel stand to borehole development compressor 1/2” x 50 m (optional 80 m) flexible rubber hose with connections and attached air probe Tubular steel frame with detachable steel handle for rolling up and storing the hose after well development
Foam pump	Engine: Honda GX 120 petrol – 3.8 HP 3 600 rev/min (also available: 4.0 HP Yanmar diesel engine, hand-start , 3 600 rev/min, air-cooled) 3-cylinder piston pump (triplex piston pump) Max. pressure 35 bar – max. flow 20 l/min 25 mm x 6 m lift pipe 25 mm x 2 m suction pipe

\* Other compressors are now available:

- XAS-186 7 bar, 186 l/s
- XAHS-186 12 bar, 186 l/s
- XAHS-236 12 bar, 236 l/s

### 3.2.2 WORKING PRINCIPLE

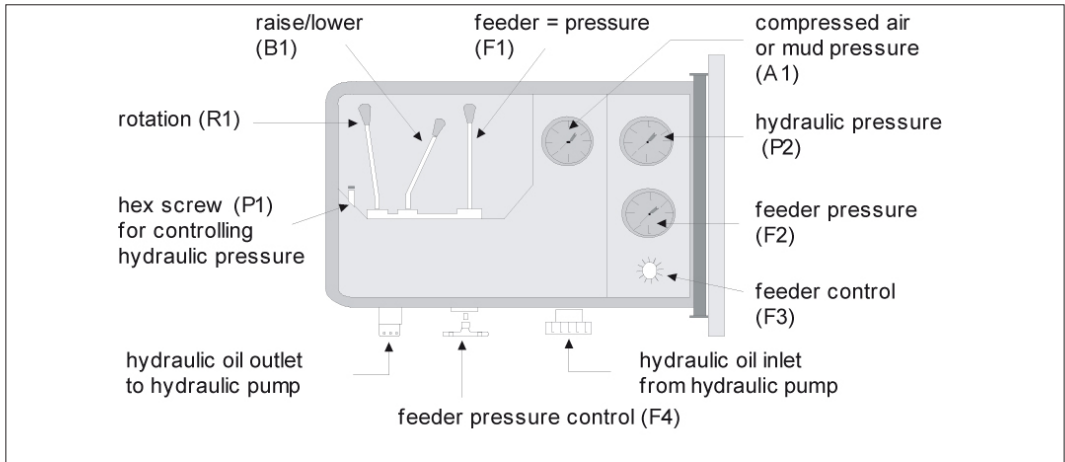
A hydraulic circuit drives a motor for rotating the drill string, and a hydraulic jack for raising or lowering the drill pipes and providing pressure on the drill bit (Figure 8.7). This jack moves the drive head up or down the pillar by means of a chain. The machine is operated from a control panel (Figure 8.8).

**Table 8.VIII: Characteristics of the PAT 301T.**

Frame	Height: 3.15 m, with crossbar of 2.25 m of useful run, equipped with 2 wheels Weight 320 kg – drilling table dia. 200 mm Mast raised hydraulically to vertical from storage position Mast equipped with 2 floodlights for night-time operations
Drive head	Hydraulic motor Rotational speed 0-45 rpm – torque 205 kgf.m (1 980 Nm) Able to swing aside for easy casing installation
Drill pipe & standard drill bits	Length of the drill pipes 2 m x 50 units – exterior dia. 76 mm Thickness 4 mm – weight 16 kg Screw thread: 2”3/8 API reg. Three-bladed bits: 2 pcs 9” (228 mm) – 1 pcs 8” (203 mm) – 2 pcs 6”1/2 (165 mm) – 2 pcs 4” (101 mm) 1 three-bladed bit 6”1/2 for clay 3 adaptors 2”3/8 x 2”3/8 API reg. (female – female) 2 adaptors 2”3/8 x 3”1/2 API reg. (female – female) Hammer: Stenuick Challenger 5”
Feed system	Drive head raised and lowered by a hydraulic cylinder and heavy-duty transmission chain Lifting capacity: 2 300 kg, max. speed: 19.5 m/min Drive-down capacity: 3 480 kg, max. speed: 14.5 m/min
Hydraulic unit	Engine: Yanmar 20 HP diesel, 2 800 rpm (portable chassis), 3 cylinders, water cooled, electric start Hydraulic oil reservoir 70 l Hydraulic pump 250 bars max.
Mud pump R Standard	Engine: Honda GX 390 – 13 HP – 3 600 rpm - petrol (or Yanmar 10 HP diesel, hand-start, 3 600 rpm, air-cooled) Pump: Taki 65-33/2 (168 kg), 1 000 l/min at 30 m head, 600 l/min at 50 m head, pressure max. 4 bar
Screw compressor for drilling	ATLAS COPCO XAH 12 bar -175 l/s* Weight 1.5 T – 2 wheels – Diesel engine: DEUTZ 115 HP
Development compressor	Engine: GX 390 HONDA 13 HP – 3 600 rpm (or Yanmar 10 HP diesel, hand-start, 3 600 rpm, air-cooled) Compressor: FUSHENG TA 80 (3 cylinders) – max. pressure 10 bar– max. flow 125 l/s 1/2” x 5 m flexible rubber hose with connections from reel stand to borehole development compressor 1/2” x 50 m (optional 80 m) flexible rubber hose with connections and attached an air probe Tubular steel frame with detachable steel handle for rolling up and storing the hose after well development
Foam pump	Engine: Honda GX 120 petrol – 3.8 HP 3 600 rpm (also available: 4.0 HP Yanmar diesel engine, hand-start, 3 600 rpm, air-cooled) 3-cylinder piston pump (triplex piston pump) Max. pressure 35 bar – max. flow 20 l/min 25 mm x 6 m lift pipe 25 mm x 2 m suction pipe

\* Other compressors are now available:

- XAS-186 7 bar, 186 l/s
- XAHS-186 12 bar, 186 l/s
- XAHS-236 12 bar, 236 l/s



**Figure 8.8: Control panel functions on the ACF-PAT 301 (1996 model).**

The hydraulic pressure provided by the hydraulic pump is 210 – 220 bars maximum, and is controlled at the inlet to the control panel by the hex-head control screw P1. If the chain breaks too often, it may be that this screw is incorrectly set.

**Pressure on the feeder F3: this imparts correct rotation in automatic setting. The control range of screw F3 is adjusted as follows: – turn the control screw for feeder F3 to minimum; – adjust the hydraulic pressure to 400 psi (manometer F2) using valve F4.**

The pneumatic hammer is driven by a compressor (235 to 283 l/s, 12 bars). The compressed air used for the hammer must be permanently fed with oil (lubricator placed between the compressor and the air admission valve). A foam pump allows a foaming agent to be injected in addition, to facilitate the transport of cuttings to the surface.

### 3.3 ACF-PAT 401 PTO kit

The ACF-PAT 401 PTO rig is a development of the 301. Its applications are the same as those of the 301, but it offers easier drilling conditions, because it is more powerful. Its characteristics are given in Table 8.IX.

The rig is powered by the engine of the vehicle which transports it: in the standard version, a Toyota Land-Cruiser or a Dyna truck. A power take-off drives the hydraulic pumps: lifting/lowering/rotation pump, mud pump, stabilising jack pump and foam pump.

The equipment is therefore powered by a single engine, totally controlled from the board situated at the back of the vehicle (see Annex 11A). Getting on the road, installing the rig and starting work are simple jobs: the vehicle is positioned, and the platform stabilised. The whole kit is air-transportable (1 vehicle + 1 compressor). The drilling platform can be mounted on the vehicle by a team of mechanics in a few days. The total weight of the kit is 4.5 tonnes.

### 3.4 Other lightweight drilling rigs

There are other drilling rigs on the market similar to the ACF-PAT. Table 8.X compares the characteristics of the main lightweight rigs used in drinking-water supply programmes. The Eureka and Dando machines are British. The Stenuick (BB) is not very widely used in drilling for water, but has some useful characteristics for DTH-hammer drilling; its special feature is the fact that it is entirely pneumatic, which simplifies maintenance. Table 8.XI compares the range of Pat drilling rigs with other similar models.

**Table 8.IX: Characteristics of the ACF-PAT 401 kit.**

---

Drilling platform (to be installed on a Land-Cruiser*)	Composed of a hydraulic unit, a control panel, oil reservoirs, 35 drill pipes, a mud pump and a foam pump, lighting and electrical system 12 volts DC Total weight of the kit with 70 m of drill pipes: 2 t
Drive head	Rotational speed 0-60 rpm Torque 2 460 Nm max Able to swing aside for easy casing installation
Drill pipe & standard drill bits	Length of the drill pipes 2 m x 35 units – exterior dia. 76 mm Screw thread: 2”3/8 API reg. Weight of each drill pipe: 15.2 kg Three-bladed bits: 2 pcs 9” (228 mm) – 1 pcs 8” (203 mm) – 2 pcs 6”1/2 (165 mm) 2 pcs 4” (101 mm) 1 tricone bit 6”1/2 1 three-bladed bit 6”1/2 for clay Adaptors 2”3/8 API reg. female x 2”3/8 API reg. female 2 adaptors 2”3/8 API reg. female x 3”1/2 API reg. female Toolbox, spares, lubricants Hammer 4” and 5”, bits 165 mm
Hydraulic unit	Deck engine: Yanmar diesel, 4 cylinders, 30 HP, 2 800 rpm, water cooled, electric start, driving hydraulic pumps System pressure 250 bar max. Reservoir capacity 125 l
Feed system	Drive head raised and lowered by a hydraulic cylinder and heavy-duty transmission chain Pull-up capacity: 3 500 kg, max. speed: 25.5 m/min Drive-down capacity: 2 560 kg, max. speed: 34.5 m/min
Stabilising jacks	2 front / 2 rear Lifting power of 6 t per jack
Mud pump	Engine: Honda GX 390 – 13 HP – 3 600 rpm – petrol (or Yanmar 10 HP diesel, hand-start, 3 600 rpm, air-cooled) Pump: Taki 65-33/2 (168 kg), 1 000 l/min at 30 m head, 600 l/min at 50 m head, pressure max. 4 bar
Foam pump	Engine: Honda GX 120 petrol – 3.8 HP 3 600 rpm (also available: 4.0 HP Yanmar diesel engine, hand-start, 3 600 rpm, air-cooled) Triplex piston pump driven by a hydraulic motor, 450 rpm, 10 l/min max., 30 bar max.
Compressor (as 301)	ATLAS COPCO XAH 12 bar – 175 l/s Weight 1.5 t Other compressors are available as for the 301
Development compressor	Engine: Honda GX 390 – 13 HP – 3 600 rpm (or Yanmar 10 HP diesel, hand-start, 3 600 rpm, air-cooled) Compressor: FUSHENG TA 80 (3 cylinders) – max. pressure 10 bar– max. flow 125 l/s 1/2” x 5 m flexible rubber hose with connections from reel stand to borehole development compressor 1/2” x 50 m (optional 80 m) flexible rubber hose with connections and attached an air probe Tubular steel frame with detachable steel handle for rolling up and storing the hose after well development

---

\* The complete kit can also be assembled on a trailer.

---

**Table 8.X: Comparison of several lightweight drilling machines.**

**P: service pressure. Q: air flow. W: power.**

	Weight of rig only or kit (t)	Lifting force (kg)	Lifting speed (m/min)	Rotation speed (rpm)	Torque (Nm)	Drilling mud pump	Compressor (DTH)	Comments
Eureka drill system	1.5	750		40-75	1 000	No	Rotary	
Dando Buffalo 3 000	1.85 1.71	7 000 Motor 20 hp + winch 3 000				No No	Options: rotary DTH cable-tool machine	
Stenuick* BB		2 600		70	1 800	Q: 250 l/s P: 12 bar	Rotary + DTH pneumatic	
ACF-PAT 201	1 (kit)	400 Manual	Manual	80-120	196 P: 4.2 bar	Q: 19 l/s –	No Rotary	Kit
ACF-PAT 301	3.5 (kit)	1 590 Intermittent	Max: 15 Nor: 10	0-40	1 320	Q: 19 l/s P: 4.2 bar	Q : 125-236 l/s P : 12 bar	Kit W: 13 HP Rotary + DTH
PAT 301T	3.5 (kit)	2 300 Intermittent	Max:19.3	0-45	1 980	Q: 19 l/s P: 4.2 bar	Q: 125-236 l/s P: 12 bar	
ACF-PAT 401 Land Cruiser PTO	4.5 (kit)	3 500 Intermittent	Max: 25.5 Min: 1.2	0-60	2 460	Q: 15.5 l/s P: 4 bar	Q: 175-236 l/s P: 12 bar Rotary + DTH	PTO kit W: 40 HP
ACF-PAT 401 Dyna PTO	4.5 (kit)	3 500	Max: 25..5 Min: 1.2	0-60	2 460		Q: 125-236 l/s P: 12 bar Rotary + DTH	PTO kit W: 40 HP
PAT 501	5.5 (kit)	4 350 Intermittent	Max: 25.5	0-50	4 840	Q: 19 l/s P: 4 bar	Q: 175-236 l/s P: 12 bar	Trailer

\* BB drill, equipped with a F624 pneumatic motor for rotation and two F575 motors for raising and lowering.

**Table 8.XI: Comparison of PAT drilling rigs.**

Description	PAT-Drill 201	PAT-Drill 301	PAT-Drill 301T	PAT-Drill 401	PAT-Drill 501
Physical formation	Alluvial, soil, clay	All kinds	All kinds	All kinds	All kinds
Drill system and operation	Manual	Hydraulic	Hydraulic	Hydraulic	Hydraulic
Rig assembly	Separate kits, 3 engines driven	Separate kits, 3 engines driven	1 complete unit, main engine driven	1 complete unit, main engine driven	1 complete unit, main engine driven
Mobility	No	2 -wheel trailer	2- wheel trailer	2 -wheel trailer Mounted on Toyota Land Cruiser	4- wheel tandem trailer Mounted on 3-t truck
Transport	Load on/off pick- up	Load on/off pick- up	Towed by pick -up	Towed by pick- up Mounted on Toyota Land Cruiser	Towed by pick- up Mounted on 3-t truck
Drill depth*	0-60 m	0-100 m	0-100 m	0-120 m	0-150 m
Drill pipe (diameter x length)	50 mm x 1.5 m	76 mm x 2 m	76 mm x 2 m	76 mm x 2 m	76 mm x 3 m
Borehole diameter in alluvia, rotary drilling, mud flushing*	3 1/2" – 6 1/2"	4" – 8"	4" – 8"	4" – 9"	4" – 9"
Borehole diameter in hard rock, DTH-hammer drilling, air flushing*	Not recommended	4 1/2" – 6"	4 1/2" – 6"	4 1/2" – 6"	4 1/2" – 6"
Air drilling, DTH-hammer	—	3"– 4" hammer	3"– 4" hammer	4"– 5" hammer	4" –5" hammer
Button-bit diameter	—	90-150 mm	90-150 mm	115-165 mm	115-165 mm
Air compressor	—	250-400 cfm, 7-12 bar	250-400 cfm, 7-12 bar	300-400 cfm, 7-12 bar	300-400 cfm, 7-12 bar
Foam pump	—	Engine driven, separate kit	Hydraulic driven, mounted on rig	Hydraulic driven, mounted on rig	Hydraulic driven, mounted on rig
Weight (without compressor)	250 kg	700 kg	1 450 kg	1 860 kg	3 080 kg
Shipping information for a complete set	1.1 t, 3 m <sup>3</sup>	Mud and air drilling, one 20 ft container	Mud and air drilling, one 40 ft container	Mud and air drilling, one 20 ft container	Mud and air drilling, one 40 ft container

\* Depends on geological conditions and skills of operators.

## 4 Borehole design

### 4.1 Choice of casing

The depth and diameter of the casing and location of the screen depend on the hydrogeological context (depth of the aquifer, exploitation flow) and the type of pump to be installed (handpump or submersible pump). The choice of casing diameter depends on the size (diameter) of the pump, which in turn depends on the flow it can provide (Table 8.XII).

A 4" pump normally passes through a casing of 100 mm diameter. However, it is advisable to leave one inch between the pump and casing and it is therefore advisable to use casing of 113 mm internal diameter for an 4" pump. This clearance must be carefully considered when an electrical submersible pump is installed. It must be large enough to limit the head-losses (especially for large head-



**Table 8.XII: Flows and diameters of submersible pumps.**

External diameter of the pump (inches)	Usual flow range (m <sup>3</sup> /h)
3"	1 – 3
4"	3 – 10
6"	10 – 50
8"	50 – 150

losses flows), but narrow enough to allow for a sufficient flow across the sides of the motor to cool it. When a motorised pump is placed below (or in) the screen a shroud must be installed in order to direct the flow across the motor to ensure cooling.

Logically, the external diameter, and therefore the thickness, of the casing depends on mechanical forces to be resisted (horizontal pressure of the ground and weight of the suspended casing). PVC casing, the most widely used for water boreholes of medium depth (no corrosion, easy to handle and install etc.), will be considered later.

The borehole diameter selected (Table 8.XIII) must allow the casing to pass freely, without force, and leave a space for the gravel pack around the screen.

**Table 8.XIII: Corresponding diameters of PVC casing and drill bits in order to ensure good working conditions.**

External diameter of the casing	Minimum diameter of the drill bit to be used
4" – 110 mm	6" – 152 mm
4"1/2 – 125 mm	6"1/2 – 165 mm
6" – 165 mm	8" – 203 mm
6"1/2 – 180 mm	8"1/2 – 215 mm
7" – 195 mm	9"5/8 – 245 mm

The quality of a borehole (sustainability, quality and turbidity of the water, exploitation flow) depends greatly on the installation of the equipment, the location of the screen relative to incoming water, the placing of the gravel pack, and finally the cementing of the annular space to avoid surface infiltration.

The size of the screen slots determines their maximum hydraulic discharge capacity. Table 8.XIV gives an example of this information for PVC screens. The table gives the upper theoretical limits although slot size is initially determined by the nature of the formation encountered during the drilling operations (see Section 6.1.1).

**Table 8.XIV: Maximum yield (m<sup>3</sup>/h) per metre of screen pipe.**

Screen diameter (mm)	Slot size					
	0.5 mm	0.75 mm	1.0 mm	1.5 mm	2.0 mm	3 mm
110	2	2.8	3.4	3.7	4.2	
125	2.2	3	3.9	4.2	5	5.7
160	3	4.1	5.4	5.8	6.5	7.5
180	3.2	4.6	5.8	6.1	7.2	8.1
200		5	6	6.4	7.6	8.6

*Note.* – Increasing the borehole diameter does not lead to much of an increase in its capacity. A series of tests was established in the USA to illustrate this, and results are shown in Table 8.XV.

**Table 8. XV: Yield versus borehole diameter.**

Diameter of borehole	D	2D	3D	4D	6D	8D
Yield*	Q	1.12Q	1.19Q	1.25Q	1.35Q	1.43Q

\* Increasing the diameter has the same influence (same coefficient) on the specific capacity ( $m^3/h/m$ ) of the borehole as on the yield ( $m^3/h$ ).

## 4.2 Pre-casing

Pre-casing is not normally required, but it may be necessary if the sides of the borehole are unstable: surface formations are not usually very consolidated, and pre-casing stabilises them for subsequent drilling. It is advisable to fix the pre-casing base with a layer of cement in the case of significant erosion and collapse problems (e.g., in granitic sands, the flow of air can create a cavity at the base of the pre-casing), or in the case of infiltration of surface pollution (e.g. a contaminated surface aquifer which needs to be isolated).

In DTH mode, it is quite likely that the sides of the borehole in the first few meters of soil will collapse (before the rocky layer is reached), especially when using foam, because of the water. As a result, the risk of getting the hammer stuck is very high. Consequently, considering the price of a hammer, it is highly advisable to install pre-casing when drilling with DTH.

In rotary mode, the risk of erosion of the borehole sides and collapsing is reduced, even at great depths (50 to 80 m), because the drilling mud stabilises the sides by caking. Also, the circulation rate of the drilling mud is not very high.

The surface formation may be loose (sand, soil), which may require several metres of pre-casing.

Non-cemented PVC pre-casing can be removed if it is less than 20 m deep. Beyond that depth it becomes impossible to remove without risking breakage. The use of steel pre-casing allows extraction from any depth, assuming enough lifting force from the machine (weight of the casing plus friction). Lightweight drilling machines such as the ACF-PAT range are not powerful enough to carry out this kind of operation beyond 20 m.

The internal diameter of the pre-casing must be several millimetres larger than the diameter of the drill bit used to drill through the underlying terrain. For example, to pass a 165 mm (6<sup>1</sup>/<sub>2</sub>) drill bit, the pre-casing will need to have an internal diameter of 178 mm. Pre-casing of 167 mm internal diameter can also be used with care and in shallow boreholes.

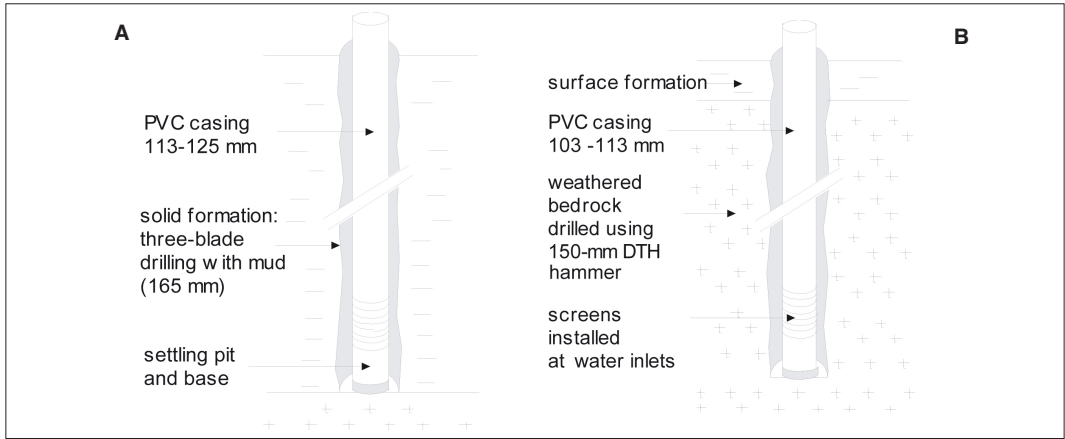
## 4.3 Usual configurations

These examples are taken from boreholes intended to take 4" handpumps or electrical submersible pumps (Figures 8.9 and 8.10).

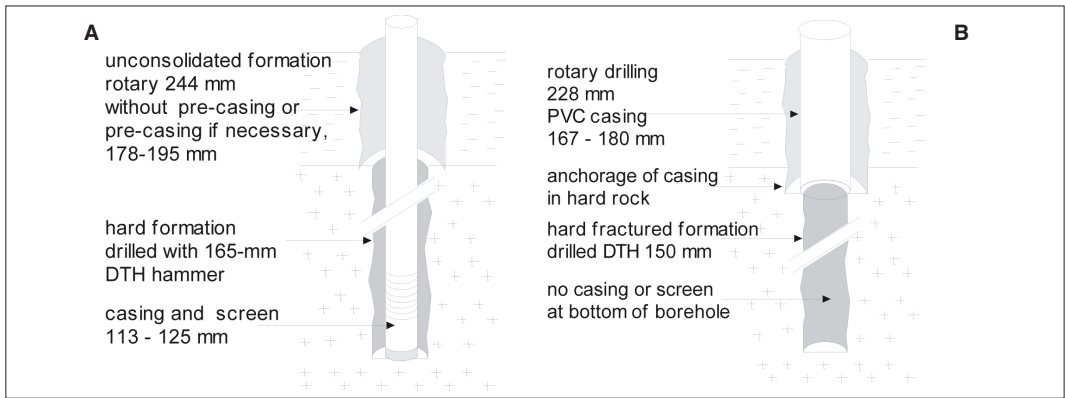
Normally, handpumps pass through casing with a 100 mm internal diameter. Kardia K 65 pumps are an exception, with their 96-mm external diameter cylinder and centralisers: casing of 113 mm internal diameter must therefore be used. Pre-casing, if necessary, will then be of 178-195 mm or 167-180 mm.

It is strongly advisable to case boreholes throughout their depth to increase life of the screen, and ensure filtering of fine particles by the gravel pack.

Sometimes some boreholes in bedrock are not cased in their lower sections (especially boreholes equipped with handpumps). The borehole is then only partially cased, to protect the less consolidated upper part, with a casing of 125 mm diameter or more. The lower, fractured section is not cased.



**Figure 8.9: Rotary drilling (A) and DTH hammer (B).**



**Figure 8.10: Mixed drilling using both rotary and DTH techniques.**

**A: complete equipment. B: partial equipment for partly consolidated formations.**

This technique is not advisable, because it affects the longevity of the borehole, even if the fractures are clean and the pumped water appears to be clear at first.

Exceptionally, when using a lightweight drilling rig in very hard formations, where drilling is very slow, the only solution is to drill to a smaller diameter borehole (100 mm) and leave it uncased.

The most usual diameters are shown in Table 8.XVI.

**Table 8.XVI: Choice of drilling diameters and equipment.**

Geological context	Technique	Pre-casing (mm)	3-bladed bit (mm)	Piping (mm)	3-bladed bit (mm)	DTH bit (mm)
Sedimentary	Rotary	167 – 180 (DN 165, 6"1/2)(9")	228	103 – 113 (6"1/2)	165	
Sedimentary	Rotary	178 – 195 (DN 175, 7")	245 (9"5/8)	113 - 125	165	
Consolidated	DTH	167 – 180	228	103 – 113 (ND 100, 4")		150 (5"7/8)
Consolidated	DTH	178 – 195	244	113 – 125 (ND 115, 4"1/2)		165 (6"1/2)

## 5 Borehole drilling

The examples and tips mentioned below refer especially to drilling boreholes with the ACF-PAT 301 machine, but the technique is applicable to other machines with similar characteristics.

### 5.1 Choice of technique

The behaviour of the formations to be drilled will depend, obviously, on their nature, but also on their water content (Figure 8.11). Only experience allows cuttings removal and drilling progress to be correctly evaluated, depending on the method used. Beyond a certain depth, the air rotary method is of no further use, because it is difficult to control (poor cuttings removal). In relatively unconsolidated sedimentary formations, the best technique is rotary drilling using drilling mud.

### 5.2 Site preparation

#### 5.2.1 INSTALLATION

The organisation of the site (Figure 8.12) must allow the driller to see the overall picture, and therefore act quickly if problems arise. Practical measures taken must include:

- a safety barrier around the site;
- access for vehicles;
- water supply (water tanks);
- easy access for filling the pits;
- a sheltered area for writing work;
- an area for spoil (cuttings);
- a levelled area to facilitate setting the machine vertical;
- location and digging of drilling mud pits;
- positioning the compressor so that it is not exposed to drilling dust (do not locate it down wind of the borehole);
- installation of all pumping units, hydraulic pressure units, and engines on a horizontal surface;
- clearly delimited work zone, with a fence if necessary.

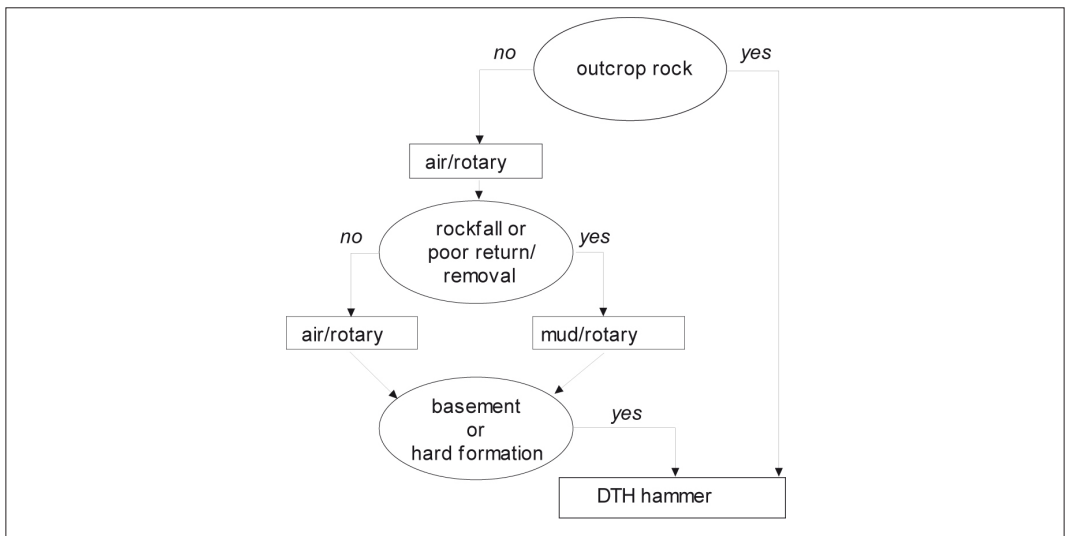
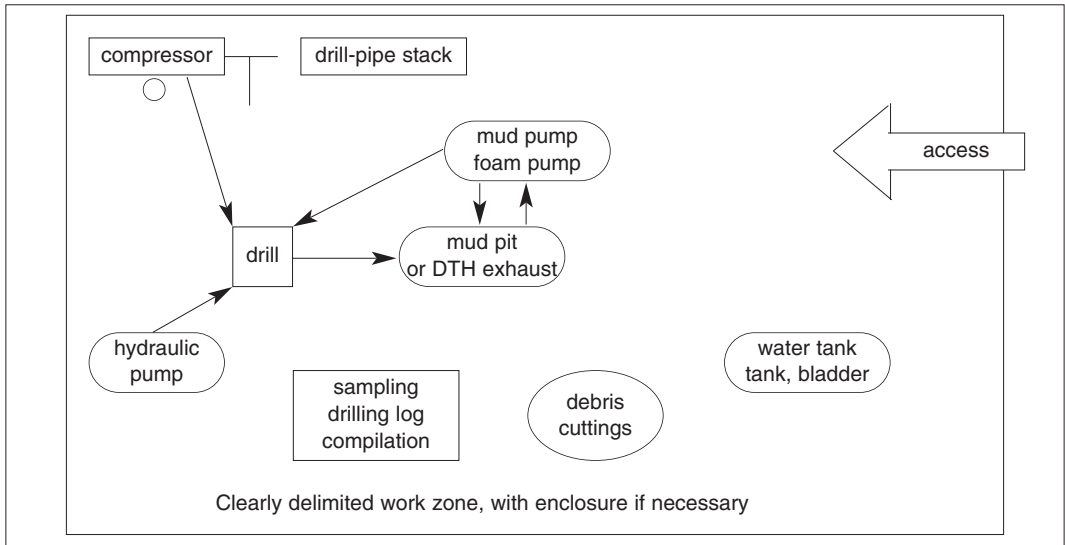


Figure 8.11: Flow chart for selection of drilling technique.



**Figure 8.12: Site organisation.**

To ensure better stability of the machine on the ground, it is advisable to fix 6-mm steel cables to the upper corners of the pole frame and to pegs firmly anchored in the ground. It is also advisable to place sandbags on the anchor arms of the machine.

The hydraulic pump unit (power pack) must be protected from the sun and placed in a well-ventilated area in order to avoid overheating, which could mean a power loss (critical oil temperature 60 °C).

The ACF-PAT 301 and the hydraulic pump are linked by two pipes which carry the hydraulic oil. The male and female connectors for these pipes cannot be wrongly connected to the pump or the control panel. The hydraulic unit must not be started before having made the connections, because that would pressurise the links and block the circulation.

Pipes must be connected during prolonged storage (a closed-circuit pipe on the hydraulic pump and one on the control panel).

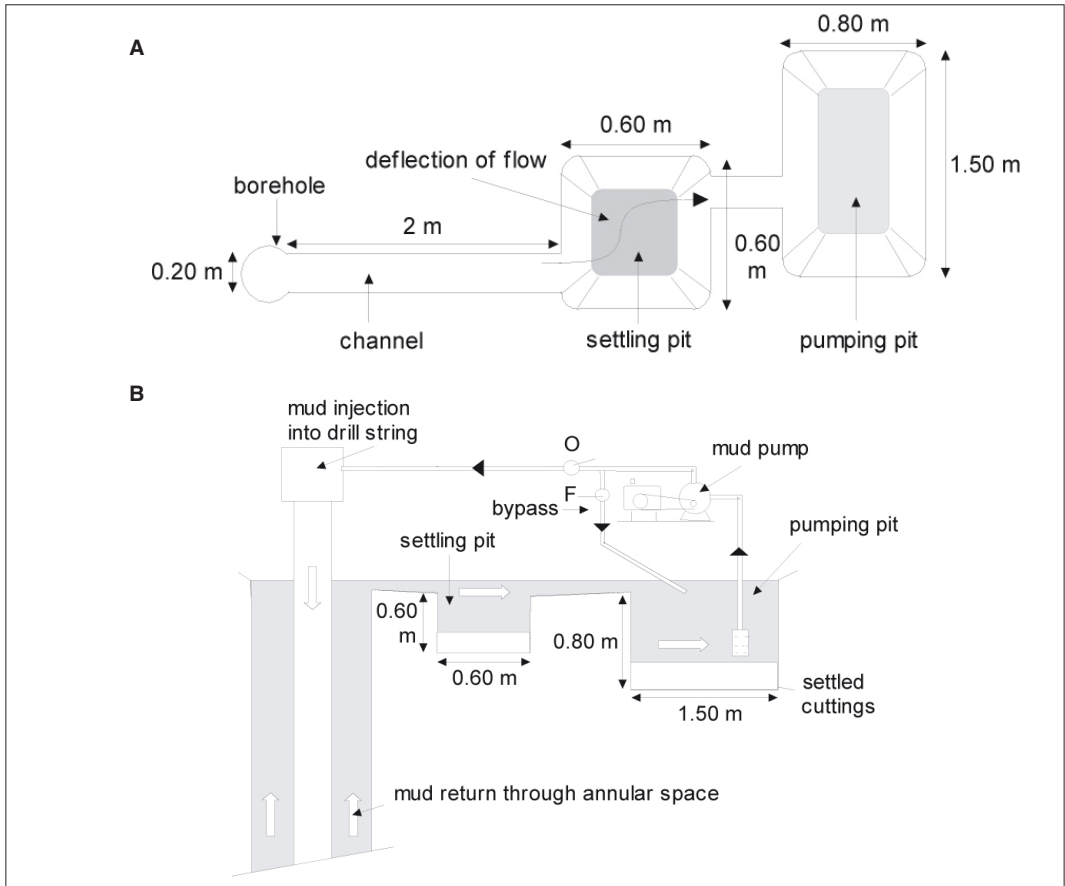
The pipe storage rack divides the drill pipes into in two groups, which helps to avoid counting errors, and therefore errors of depth drilled. It is always advisable to number them so as to differentiate them. The threads must be protected by plugs/caps and systematically greased (drill pipes and drive head) with copper grease every time they are used, to ensure the drill string is watertight and to prevent seizing.

If the machine is mounted on a vehicle, the site should be set out in the same way. On a light vehicle such as the Land-Cruiser 4x4, the hydraulic pressure unit and drill pipes are on the back, and the compressor is towed by another vehicle which transports the rest of the equipment. On 5-t trucks, it is possible to mount the compressor as well.

Setting up a site with a machine fixed on a vehicle is quicker. The jacks are used to stabilise the rig in the vertical plane, and lift and the vehicle. Beams must be placed under the jacks to distribute the weight over a larger ground area.

## 5.2.2 MUD PITS

Mud pits form a reservoir of drilling fluid, and allow recycling after settling of the cuttings. For shallow boreholes (20-30 m) in unconsolidated formations, the dimensions given in Figure 8.13 and Box 8.3 can be used.



**Figure 8.13: Mud circulation.**  
**A: plan view; B: section view.**

A first channel of 2 m in length and 0.20 x 0.20 m cross-section is dug from the location chosen for the borehole, emptying into the first pit. It must be long enough for the pit to be beyond the edge of the slab of the future water point in order to avoid differential settling under the slab.

**Box 8.3**  
**Mud pit design.**

The dimensions of the mud pits are calculated bearing in mind the depth of the borehole to be drilled. Ideally, the total volume of the pits must be equal to three times the volume of the borehole, with (dimensions in m):

- for the settling pit:  
width =  $\sqrt[3]{(\text{volume borehole in litres} \times 0.57)}$   
length = 1.25 x width  
depth = 0.85 x width
- for the pumping pit:  
width = as for the settling pit  
length = 2.5 x width  
depth = 0.85 x width

The first pit (settling pit) facilitates the sedimentation that is started in the channel. Its volume is  $0.2 \text{ m}^3$  ( $0.6 \times 0.6 \times 0.6 \text{ m}$ ).

The axis of the second channel must be offset from that of the first one, so as to deflect and attenuate the flow to facilitate settling.

The second pit (pumping pit) is a reservoir from which the drilling mud is pumped to be injected into the drill string; its volume is about  $1 \text{ m}^3$  ( $1.5 \times 0.8 \times 0.8 \text{ m}$ ). The pits and channels are regularly scraped out and cleaned of sediments formed in the course of the drilling process.

### 5.2.3 PREPARATION OF DRILLING MUD

In clay formations, it is preferable to drill with water only, to avoid blocking the aquifer. The water will become loaded with clay from the ground as drilling proceeds.

If there is no reliable information about the nature of the formations to be drilled, the drilling water must be mixed with bentonite or polycol to increase its density and to prepare drilling mud which can be thickened or thinned, as follows:

- polycol is a polymer which is very widely used in rotary drilling. It must be mixed in a proportion of 2.5 to 5 kg per  $\text{m}^3$  of water. The water-polycol mixture is more homogenous than the mixture of water and bentonite, and it needs less attention in its use. There are many types of polycol with different characteristics, suitable for different contexts (biodegradable, anti-colloidal, suitable for a saline environment, suitable for different climates etc.);

- bentonite is a powdered clay which must be mixed in a proportion of 15-30 kg per  $\text{m}^3$  of water. It risks sealing the aquifer, but this sealing property makes it better for very permeable formations (gravels, sands), where the losses of drilling mud and the risk of collapse can be significant.

Clean water should be used for drilling mud. It is essential to have a 5 – 10  $\text{m}^3$  water store (bladder or water barrel) for the site, to be able to make up any loss of drilling mud as quickly as possible.

The density of the drilling mud must be adjusted as the drilling advances. With experience, and depending on the formation being drilled, the driller adjusts the density according to the feel of the mud. Clay has the effect of thickening the mud, therefore it is necessary to thin it by adding water. In loose or sandy formations, it is necessary to use quite dense mud, as ingress of groundwater can thin it excessively.

To obtain a homogenous mixture, the polycol or bentonite must be sprinkled over the water jet while filling the pit. A mixer can be made with some fittings: a venturi tube is made, and then connected to the bypass on the discharge side of the mud pumps (Figure 8.14).

The drilling mud is circulated from pit to pit so that it remains homogenous before the effective start of drilling.

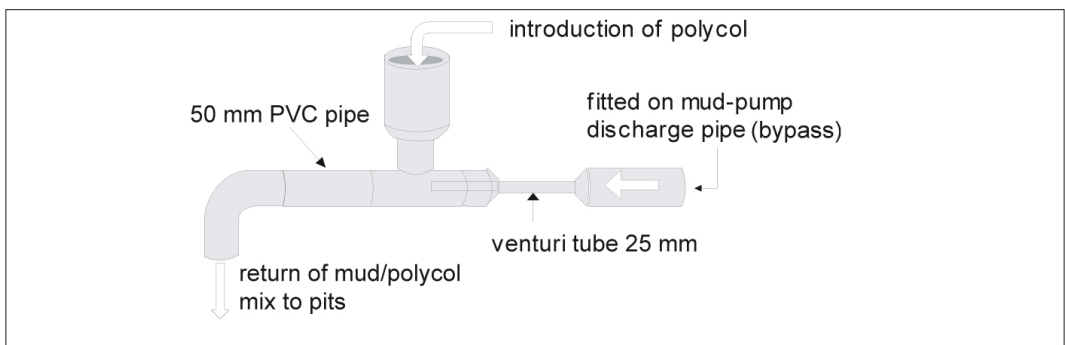
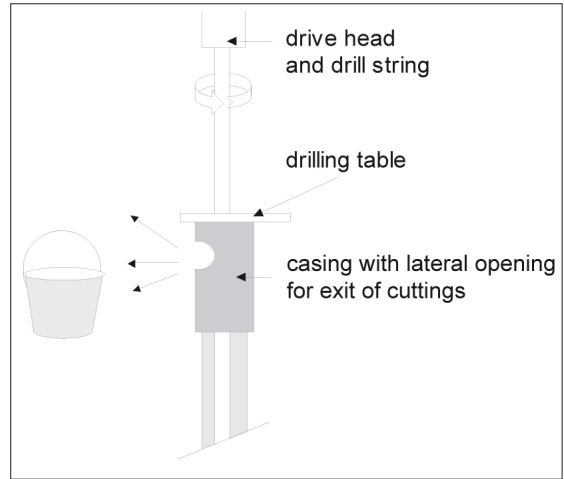


Figure 8.14: Venturi mixer made from PVC fittings.

## 5.2.4 REMOVAL OF CUTTINGS IN THE DTH TECHNIQUE

The cuttings (and the water with foam) are raised to the surface by blowing compressed air, and then channelled to allow sampling (and the estimation of the flow).

When the machine is installed on a vehicle, the mixture of water and cuttings strikes the underside of the deck. It is necessary to create a circular area on the ground which directs the flow towards a drain. In practice, the most effective means of channelling the cuttings and avoiding splashing is to place 1-2 m of casing (Figure 8.15) under the drilling table. A bucket is placed under the shower of cuttings.



**Figure 8.15: Collection of cuttings.**

## 5.3 Rotary drilling

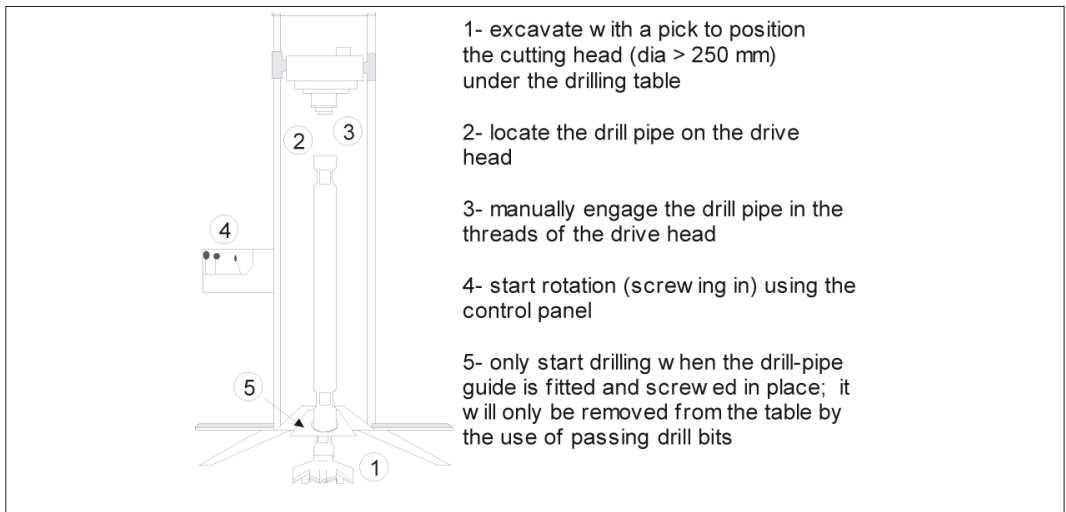
### 5.3.1 STARTING

It is absolutely essential to follow the procedures given in Figure 8.16.

### 5.3.2 ADVANCE: ADDING A DRILL PIPE

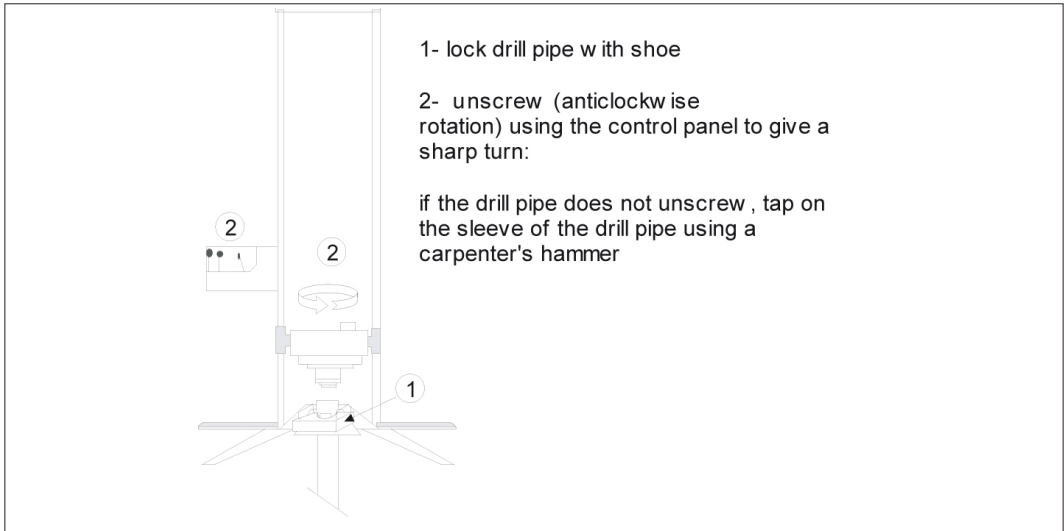
Drilling progress is regulated by the rotational torque and pressure on the drill bit controlled from the control panel. The possible solutions to drilling problems are explained in detail in paragraph 5.3.4.

The borehole must be drilled down to the end of the drill pipe passage in order to create a space between the bottom of the hole and the drill bit when the drill pipe has to be changed. When the end of a drill pipe is reached, it is raised and lowered by its full length in order to check the hole and clear the borehole sides. A drill pipe can be added as long as the drilling mud is not too full of cuttings (Figure 8.17).



**Figure 8.16: Fitting the first drill-pipe.**

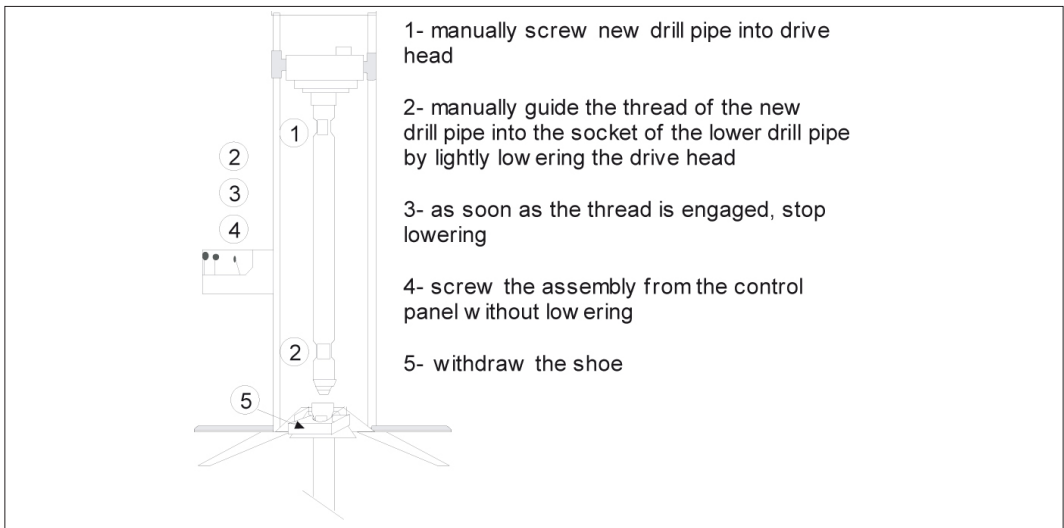




**Figure 8.17: Unscrewing a drill pipe.**

After switching over the mud-pump outlet to circulate mud from pit to pit (slowing the motor), it is possible to change the drill pipe. Stopping and restarting the flow of mud must be done as smoothly as possible in order to avoid any destabilisation of the borehole sides.

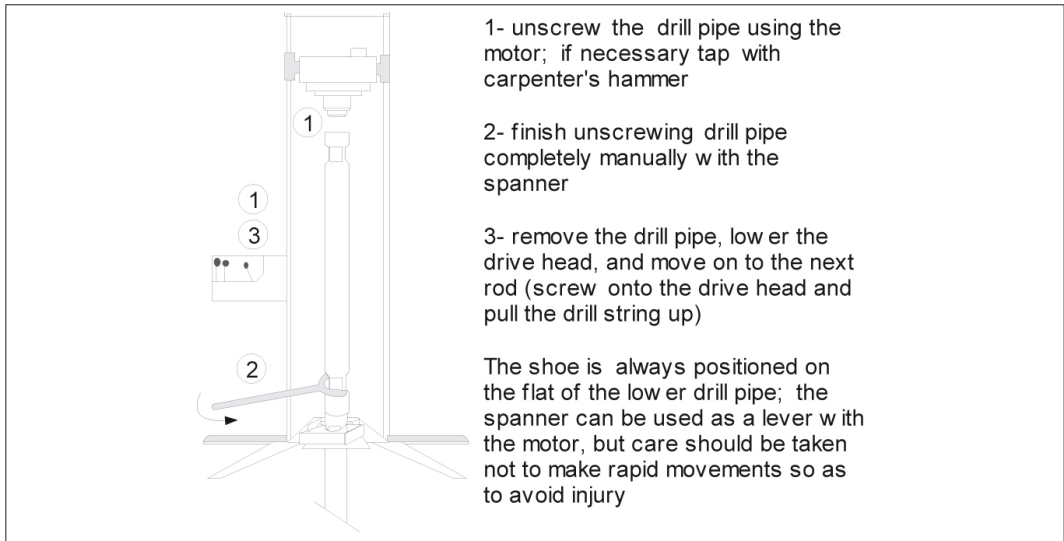
The locking shoe holds the drill pipes suspended in the borehole during the addition or removal of drill pipes: it engages at the level of the drill pipe flats (Figure 8.18).



**Figure 8.18: Locking drill pipes in suspension.**

### 5.3.3 REMOVAL OF A DRILL PIPE

The drive head is lifted into the high position and the shoe engaged on the flat of the lower drill pipe. To remove a drill pipe, it is necessary to unscrew the upper thread using the drive head first, then the spanner, and then to unscrew the lower thread (Figure 8.19).



**Figure 8.19: Removing a drill pipe.**

### 5.3.4 COMMON PROBLEMS

Many difficulties may appear in the course of the drilling process, but most of them are simple to overcome with a little experience (Table 8.XVII). Success depends on constant monitoring of all the factors which may influence the progress of the operations, on precise observation of the cuttings, and on 'listening' to the machine: experienced drillers are very attentive during the key phases of the drilling process, to detect the slightest problem.

**Table 8.XVII: Frequently-encountered problems in rotary drilling and recommended solutions.**

Observations – difficulties	Recommended solutions
Significant losses and/or dilution of drilling mud	Increase the density of the drilling mud Use bentonite rather than polycol Install pre-casing
Thickening of drilling mud	Empty and clean pits Add clean water
Sides of borehole not stabilised and collapsing, erosion of sides	Increase density of drilling mud Reduce fluid circulation rate Reduce cleaning and circulation time Case immediately Install pre-casing
Sides collapsing, circulation stopped, rotation blockage	Increase pressure and flow of drilling mud Lift drill string until circulation returns to normal Install pre-casing
Sealing of aquifer	Clean with water to break the cake Use polycol rather than bentonite

### 5.3.5 ANALYSIS OF CUTTINGS AND SIGNS OF WATER

The geological section of the ground being drilled is established by the hydrogeologists or their assistants as the borehole goes along, and described in detail in the borehole report. The cuttings which come to the surface with the drilling mud are a source of essential information: their geological analysis helps to identify the formations traversed, and to know their nature, whether they are permeable (indicating a reservoir) and capable of providing water. Samples are taken with each change of drill pipe and formation, by hand, just at the borehole outlet, and placed in a box with different compartments in order to visualise the geological section. They are then preserved in plastic bags marked with the name of the borehole and the depth at which the sample was taken. The samples are always covered in drilling mud, which makes them difficult to interpret, so they have to be rinsed with clean water.

In rotary drilling, there is nothing that clearly indicates the presence or absence of water during the drilling process: only water tests (direct blowing) and pumping tests, carried out once the borehole has been equipped, allow the presence of water to be confirmed, and the exploitation flow to be evaluated. Nevertheless, during the drilling process, there are several signs of water that allow an aquifer area to be located:

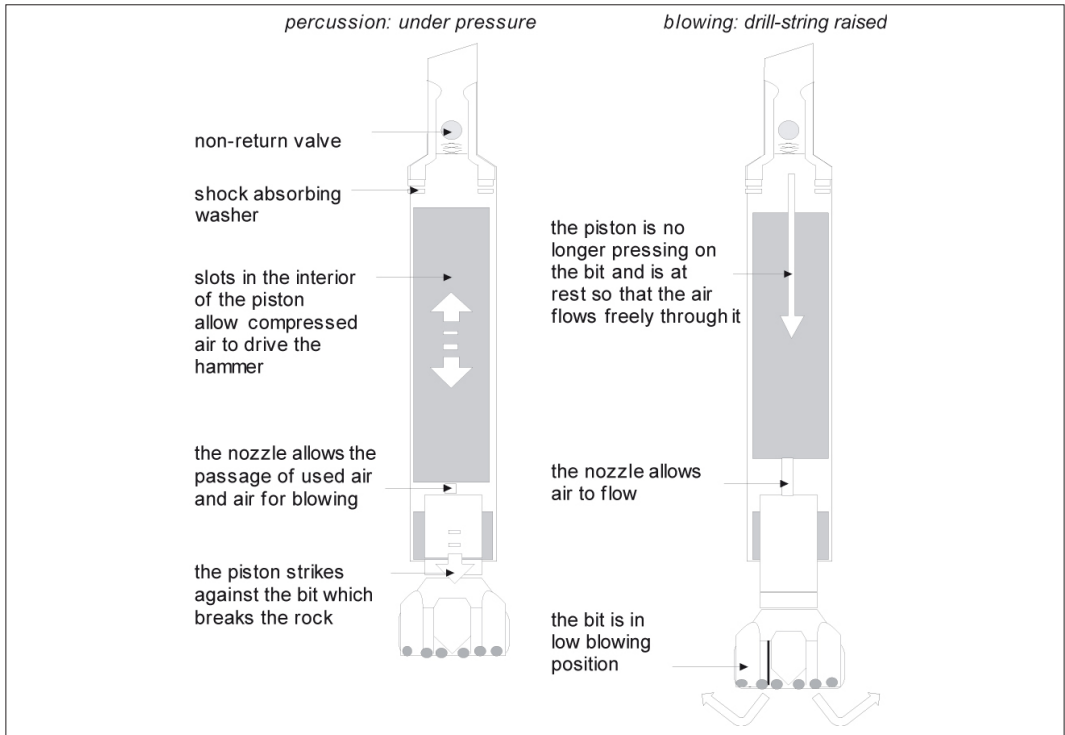
- analysis of the cuttings, as noted before, indicates the presence of an aquifer by revealing layers of permeable material (sands, gravels), supported by cross-checking with the information gathered in other boreholes drilled in the same area and which have turned out to be positive;
- loss of drilling mud, which means leakage of drilling mud into the surrounding ground, becomes evident from rapid decrease in the levels in the pits during circulation, or in the borehole after the circulation has stopped (for example, while a drill pipe is being changed). These phenomena indicate that the borehole is passing through layers of permeable material;
- traces of oxidation and visible alterations on the grains of quartz and feldspar (ochre/rusty aspect) are signs of groundwater movement. However, these may be old signs, relating to water movements in the past, and they may not reflect the current situation (e.g. if the static level has dropped);
- thinning (i.e. dilution) of drilling mud indicates groundwater ingress. But this phenomenon is rarely detected, because the pressure of the drilling mud is usually higher than that of the aquifer, and the aquifer is usually plugged by the cake.

## 5.4 DTH percussion drilling

### 5.4.1 ADJUSTMENT AND LUBRICATION OF THE DTH HAMMER

The DTH hammer is a precision tool, consisting of a piston which slides in a cylinder due to the passage of compressed air through a set of cavities. The piston strikes the drill bit during the percussion phase and releases compressed air during the blowing phase (Figure 8.20).

It is essential to keep the hammer lubricated, and so the injected air must itself be lubricated throughout the length of the drilling. A lubricator is located between the compressor and the air-admission valve of the drilling rig, injecting biodegradable drilling oil. The operation is checked by blowing the lubricated air onto a small board placed under a suspended drill pipe. Optimum flow (0.2 l/h) occurs when the board is lightly and evenly sprayed. Adjustment is carried out with the screw situated on the lubricator: the screw at the base is turned fully to the right (closed), then unscrewed a quarter turn to the left. If foam is added, the quantity of oil used must be higher. Every time a drill pipe is changed, it is essential to check the presence of oil in the air coming out of the drill head. Finally, when the hammer is completely dismantled, it is necessary to oil it (by direct introduction of hydraulic oil) and to grease all the threads (with copper grease).



**Figure 8.20: Hammer function.**

#### 5.4.2 INSTALLATION OF THE HAMMER

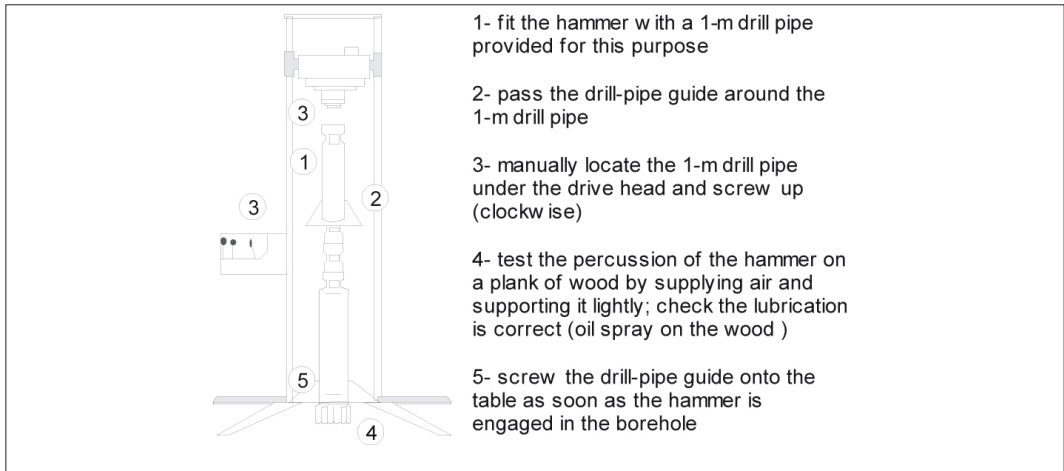
In bedrock areas, weathered layers are drilled in rotary mode using either air or drilling mud until the bedrock is reached, when drilling continues using a hammer (Figures 8.21 and 8.10).

Certain precautions must be taken for the installation and lowering of the hammer to the bottom of the borehole:

- all drill pipes must be cleaned with air from the compressor to remove all drilling mud residue before the hammer is connected (to avoid damage to the hammer);
- before storage, all dry drilling-mud residue must be cleaned from the drill pipes used for rotary drilling, with water from with the foam pump in high-pressure washer position;
- before lowering the DTH hammer, the depth of the borehole must be measured (with a dipper) in order to check for possible collapse;
- when each drill pipe is added, it is cleaned after being screwed to the drive head and before being connected to the drill string (place a board on the drill pipe locked in the shoe and blast with air to flush out contaminants);
- drilling mud contained in the borehole is regularly flushed (by air blowing) as the hammer descends. If the hole is pre-cased and the space between the casing and the drill bit is small (just a few millimetres), there is always a risk of putting the hammer into percussion mode if it rubs against the sides of the casing, which would damage it.

#### 5.4.3 DRILLING PROCESS

Before starting percussion, clockwise rotation is commenced and then maintained during raising or lowering of the drill string. It is only stopped when all other operations cease.



**Figure 8.21: Fitting the hammer.**

Any anticlockwise rotation can unscrew the drill string or the hammer completely, causing them to fall to the bottom of the borehole; this can be aggravated by the vibrations caused by percussion. The recovery of a drill bit or part of the drill string requires specific tools and is a delicate operation. Anticlockwise rotation during percussion is therefore to be avoided at all costs.

#### 5.4.3.1 Starting the hole

With the air flow shut off, the drill bit is placed several centimetres above the ground to be drilled, and clockwise rotation is started. The air is turned on, and the hammer is gradually pressed onto the ground until percussion starts.

Initially, air flow is opened half way, percussion is relatively weak, and rotation slow, until the drill bit penetrates the ground. The air valves are progressively opened to increase percussion.

Pressure and rotation are then controlled to give regular advance.

#### 5.4.3.2 Advance

Good drilling involves a balance between pressure and rotation, giving constant penetration speed and regular, smooth rotation (Figure 8.3).

The borehole is regularly purged (every 50 cm) by blowing in order to remove cuttings and avoid blockage. Large cuttings tend to remain in suspension above the DTH hammer during the drilling process. If air circulation stops, cuttings can fall back onto the hammer and block it.

To purge the borehole, the hammer is slightly withdrawn (stopping percussion) and set to the blowing position. The total air flow provided by the compressor must allow the borehole to be purged of all cuttings. It may be necessary to sweep up the height of the drill pipe to purge the borehole thoroughly.

#### 5.4.3.3 Addition and removal of drill pipes

The procedure explained in Sections 5.3.2 and 5.3.3 for rotary drilling can also be consulted.

Before unscrewing the drill pipes, the residual pressure in the drill string is checked with a manometer. This pressure remains high if a plug of cuttings is formed in the annular space (see Section 5.4.4 for precautions to be taken to avoid this); in this case the drill pipes must be unscrewed carefully to release pressure gradually.

Air lubrication is checked with the addition of each drill pipe.

#### 5.4.4 DIFFICULTIES AND POSSIBLE SOLUTIONS

Air drilling of formations covered by unconsolidated material that has not been pre-cased can present difficulties:

- in the first stages of drilling, the pressurised air can erode and undermine the soil around the borehole, thus endangering the stability of the drilling rig;
- during the drilling process, the movement of cuttings to the surface erodes the sides of the borehole, which may cause collapse and block the drill string;
- air losses in very loose formations can lower the rise-rate of the cuttings.

If the surface formation does not have a minimum of stability, and if the cuttings do not rise to the surface correctly and so create a blockage, the rotary technique, using drilling mud rather than air must be used. If the surface formation collapses, pre-casing is essential before continuing drilling with the hammer.

For the problems usually encountered during the drilling process, there are several solutions, as recommended in Table 8.XVIII. The addition of foam (polymer) appreciably modifies the characteristics of the circulating air, and solves a certain number of problems (return of cuttings, filling and air losses in the ground).

**Table 8.XVIII: Frequently-encountered problems in DTH-hammer drilling and recommended solutions.**

Observations – difficulties	Recommended solutions
Poor rise of cuttings to the surface	Longer blowing time Injection of foam and water
Decrease in air flow at the borehole exit – blockage of cuttings High residual pressure in drill pipes	Injection of foam and water Care while unscrewing drill pipes
Air losses in surface formations	Injection of foam Pre-casing if necessary
Blockage with dry or slightly damp cuttings Formation of small balls	Injection of water and foam if necessary Frequent high-pressure blowing Pulling up drill string
Erosion of the borehole sides due to air flow and return of cuttings to surface	Decrease in air flow Use of foam Pre-casing
Formation of a large cavity	Stop drilling Immediate casing, or pre-casing
Drill bit blockage by falling debris	Sharp rotation, raising and lowering to crush the debris High-pressure blowing with water and foam
Blockage of rotation	Percussion and sharp restart of rotation Light anticlockwise unscrewing to increase amplitude of jolts
Drilling in a cavity	Left to the drillers' judgement

#### 5.4.5 ANALYSIS OF CUTTINGS, SIGNS OF WATER AND FLOW CALCULATION

As the fluid used in DTH drilling is air, the cuttings will be clean and not mixed with drilling mud, facilitating analysis. Even the use of foam doesn't hamper the observation of the cuttings. Generally, the bigger the cuttings, the more friable the drilled formation is, and the finer they are (dust), the harder the drilled rock is. The presence of fractures is usually identified by larger cuttings. Additionally, any signs of erosion on these cuttings could indicate a water flow (current or historic).

In drilling with air, ingress of water is visible and quantifiable in most cases (return of a mixture of water and cuttings when blowing). However, some water ingress may not be noticed because it is blocked by the cuttings that form a cake on the sides of the borehole.

It is easy to estimate water flow during the drilling process to decide when it should be stopped, and the borehole equipped. Flow measurements are taken at each significant water ingress (blowing). In addition, all water emerging from the borehole is channelled to an outlet equipped with a pipe to facilitate measurement using a bucket.

Ingress of water in the finished borehole must be regular and continuous. The measured flow is generally less than the borehole capacity, because the cuttings block some supply zones, and the borehole is still not fully developed. Nevertheless, ingress of water is generally progressive: it appears first in the form of traces of dampness, and then, as the borehole advances, in the form of a cumulative flow coming from various fissures or fractures. In some cases, crossing a well-supplied major fracture causes a sharp increase in flow.

## 6 Borehole equipping

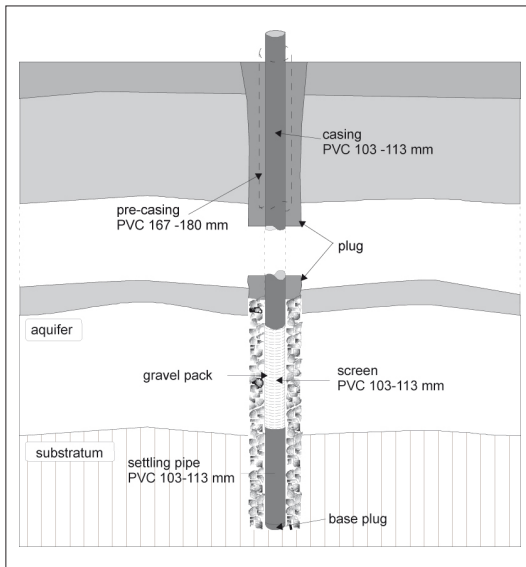
Equipping the borehole (installing casing and screen) is an essential stage in the construction of a water borehole. The casing plan and the position of the screen have a great influence on the yield of the borehole, as well as its longevity. The aquifer must be protected from surface pollution which can enter down the side of the casing by the surface works and the cement plug (Figure 8.22).

### 6.1 Permanent casing

#### 6.1.1 CHOICE OF CASING AND SCREEN

PVC is the most suitable material for shallow boreholes. It is preferable to use proper reinforced casing with screw joints. The mechanical strength of the casing can be calculated (Box 8.4). It must be strong enough to avoid pipe deformation during installation, as holes are not always circular, and during pumping, which applies pressure on the pipe.

Strictly speaking, the screen slot size depends on the grain size of the aquifer (Table 8.XIX). Before drilling starts this is not always known, but usually the slots should be between 0.5 and 2 mm wide.



**Figure 8.22: Borehole equipment**  
(based on ACF, Uganda, 1997).

#### Box 8.4

##### Resistance of the casing to crushing.

For water boreholes, an important mechanical characteristic of the casing is its crush resistance. Sometimes this information is provided by the suppliers, but it can be calculated using the following simplified formula:

$$Re = K \cdot E \cdot (e/D)^3$$

where  $Re$  is the crushing resistance (bar),  $K$  a non-dimensional coefficient (for PVC  $K = 2.43$  (Tubafor®), for steel  $K = 2.2$ ),  $E$  the modulus of elasticity (bar) of the material at 20°C (for PVC  $3 \times 10^4$ , for steel  $2 \times 10^6$ ),  $e$  the thickness of the casing wall, and  $D$  its external diameter.

For slotted casing (screen), calculated values should be multiplied by the coefficient  $(1 - F)$ , where  $F$  is the fraction of voids. For particular cases, consult the supplier.

The forces, i.e. the lateral pressure on the casing, are generally calculated from:

- the specific weight of the ground, with the lateral forces equal to half the vertical forces, which are themselves equal to the weight of the unconsolidated, dry or saturated ground above (specific weight of 2 to 2.5). Therefore, it is usually considered that hard formations do not exert any lateral pressure;
- the pressure due to the presence of water or drilling mud in the borehole (hydrostatic pressure in bar  $P = H d/10$ ).

For example, if the static level is near the surface and the formation is unconsolidated, the horizontal pressure is then 20 bars for each 100 m of depth (weight of the ground divided by  $2 + 10$  bars of hydrostatic pressure).

However, bearing in mind the small cross-sectional area of the boreholes, the vault effect of their sides protects the casing from lateral ground pressure. In practice, only the static and dynamic hydrostatic pressures are taken into account. These pressures are increased during pouring of cement grout, lowering the casing, and sharp reduction of water level during development.

For shallow boreholes in hard bedrock, experience has shown that it is enough to consider a horizontal pressure of 0.75 bars per 10 m section. Therefore, casing with a strength of 7.5 bars can be installed in a 100 m borehole.

During drilling of the first boreholes, the grain size of the aquifer can be easily identified by analysing the cuttings with a sieve. Table 8.XIX gives the grain size of gravel pack and the screen slot size recommended for different aquifer grain sizes encountered underground.

**Table 8.XIX: Choice of screen slot and gravel pack per aquifer grain size.**

Aquifer grain size	Gravel pack grain size	Screen slot size
0.1 to 0.6 mm	0.7 to 1.2 mm	0.50 mm
0.2 to 0.8 mm	0.1 to 0.5 mm	0.75 mm
0.3 to 1.2 mm	1.5 to 2.0 mm	1.00 mm
0.4 to 2.0 mm	1.7 to 2.5 mm	1.50 mm
0.5 to 3.0 mm	3.0 to 4.0 mm	2.00 mm

#### 6.1.2 CASING FITTING

The risk of collapse could be high, and the casing is therefore fitted as quickly as possible. The borehole must not remain unprotected for any length of time, because there is always the risk of losing the borehole through collapse of the sides.



The casing plan (length and position of casing and screen) is established according to the geological profile of the borehole where the different strata and points of ingress of water are noted. Diagraphy's tests (electrical resistance, gamma ray, neutron) can be carried out before casing to improve the casing plan, especially in sedimentary formations, with the use of rotary drilling, where it is sometimes difficult to identify the aquifer horizons (see Chapter 5).

The screen is placed so that its bottom is level with the bottom of the aquifer or zone of water ingress, with its length chosen according the following rules:

- confined aquifer: 80 to 90% of the thickness of the aquifer
- unconfined aquifer: 30 to 60% of the thickness of the aquifer

The issue is to find a good compromise between having screens long enough to reduce the velocity of the water moving towards the borehole, and short enough to allow the installation of the pump above the screen, to avoid draw-down of the water table below the level of the screen.

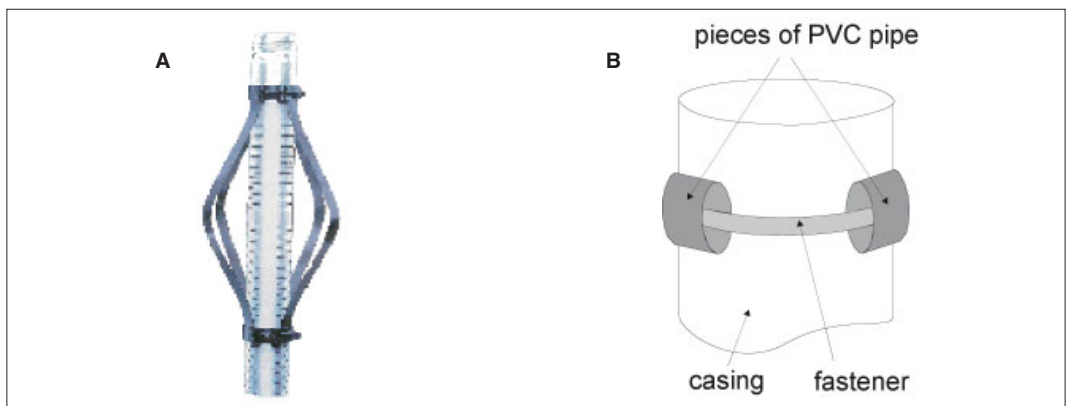
Placing the pump within the screen itself can damage the screen: the high velocity of water causes erosion of the slots, and the pump hits the screen when starting. The gravel pack and the aquifer around the screen are also destabilised in the long term. The pump may also be damaged by drawing fine material into it and by causing cooling problems (water flow must arrive down the pump to cool the motor; a shroud can be used to orient the flow).

The de-watering of the screen presents several risks; oxygenation of the aquifer can favour the precipitation of metals (Fe, Mg etc.) that clogs up the screens and encourages the development of bacteria (see Chapter 8B). It also accelerates the compaction of the aquifer.

These rules have to be strictly applied for a motorised borehole (the pump should be installed above the screen or should have a shroud if installed below it). For handpumps the velocity of the water is lower and the longevity of the borehole is not so affected by having the pump within the screen (in this case, centralisers around the pipe of the pump must be used to avoid the pump cylinder hitting the screen during pumping).

Moreover:

- the bottom section of the casing must be a length of unslotted casing of about 0.5 m, plugged at the bottom (settling pipe);
- since the casing does not always reach the bottom of the borehole (cuttings suspended in the drilling mud falling back when circulation stops, or collapse of the material from the borehole sides), it is necessary to reduce the length of the casing by 0.5 to 1 m in relation to the actual



**Figure 8.23 Centralisers.**

**A: commercial model. B: in Angola, centralisers were made by fixing small pieces of PVC pipe secured with fasteners around the casing. One centraliser was installed on each screen section, and one per two or three casing sections.**

depth drilled (after drilling several boreholes in the same area, the driller should be able to estimate the height lost during drilling and adapt accordingly);

– the top of the casing must extend to about 0.5 m above the surface of the ground.

The lengths of casing could vary with the joint threading, so it is advisable to measure each length.

The casing must pass freely down the borehole under its own weight. If the borehole is not vertical, friction between the casing and the borehole sides can block the installation. Light pressure on the casing can facilitate its descent, otherwise it is necessary to return it to the surface and rebore the hole.

An alternative method consists of lowering the casing without a bottom plug so that it can scrape down the sides. In this case, it is recommended to seal the bottom of the borehole with cement grout pumped down from the surface once the casing is in place.

In order to guarantee correct positioning of the casing in the borehole and an even gravel pack around the screen, it is recommended to install centralisers. Various suppliers produce centralisers, but they can be easily made in the field (Figure 8.23).

## 6.2 Gravel pack and grouting

### 6.2.1 GRAVEL PACK

The gravel pack allows for a larger screen slot size to be used, increasing the yield from the borehole by reducing the velocity of the water entering the screen (therefore reducing head-loss). The gravel pack also helps in the stabilisation of the surrounding aquifer.

The gravel pack must be reasonably uniform, calibrated, clean, round and preferably siliceous, to guarantee good porosity and longevity. It must not be calcareous, lateritic or crushed.

In practice, the gravel pack grain size is defined by the grain size of the aquifer and the slot size of the screen: the gravel must be as fine as possible without passing through the screen (Table 8.XIX).

The gravel is passed down through the annular space between the casing and the sides of the borehole. The use of a funnel (sheet metal, plastic sheet or pipe) facilitates its introduction.

If the falling gravel blocks the annular space, circulation of water can clear it.

Mud rising up through the casing indicates that the gravel is falling correctly. When the level of gravel reaches the top of the screen, the mud no longer comes up through the casing, but through the annular space. The gravel filter must then go on a few metres beyond the height of the screen (compaction may occur after installation). This level can be checked with a dipper in shallow boreholes.

The volume of gravel required can be defined theoretically (volume of the borehole minus volume of the casing) or empirically (Box 8.5), but in practice, more gravel is always needed than is estimated (non-rectilinear hole, formation of cavities etc.). Table 8.XX gives some approximate volumes of gravel required for various borehole and casing diameters, in litres per metre height of gravel pack.

**Tab 8.XX: Volume of gravel in relation to borehole and casing diameter.**

Borehole diameter	Casing diameter	Volume of gravel (l/m)	
		Theoretical volume (empirical formula)	Likely real volume
3"3/4	1"1/2	6	10.16
3"3/4	2"	5.1	9.5
5"3/4	4"	8.65	12.67
6"1/2	4"	13.3	19
6"1/2	4"1/2	11.15	15.83

### Box 8.5

#### Volume of gravel.

Empirical calculation of the volume of the gravel filter:

$$V = h \times \pi \times (D^2 - d^2) \times 0.16$$

where V is the volume of gravel (l), h the height of the gravel filter (m), D the diameter of the borehole (inches) and d the diameter of the casing (inches),  $\pi = 3.14$ . The factor 0.16 is here to correct the difference of units.

## 6.2.2 GROUTING

Grouting is an essential operation which protects the borehole from external pollution; even if a slab is cast around the casing, only proper grouting can prevent water filtering down the side of the casing. Grouting can be done with clay or with a mixture of bentonite and cement.

A clay plug must be placed on top of the gravel pack in order to stop the grout from plugging the gravel pack. The bentonite continues to swell over time, guaranteeing the seal even if the grout becomes damaged.

### 6.2.2.1 Preparation of the grout

The operation consists of filling the annular space above the gravel filter with a mixture of water and cement (grout) up to ground level. When the borehole is deep, one plug can be put above the gravel pack with another in the last two metres, the intermediate space being filled with clay (cuttings).

The proportion is about 50 l of water for 100 kg of cement, which gives 75 l of grout. If bentonite is available, the following mixture is used: 70 l of water, 4 kg of bentonite and 100 kg of cement. This second mixture stops the water from filtering out of the grout, but its setting time is slightly longer.

### 6.2.2.2 Placing the grout

The procedure involves filling the annular space up to ground level, and then leaving to set for a minimum of 12 h before starting development and pumping tests.

Generally, grouting must be carried out before pumping tests. Nevertheless, if it is not possible to wait for 12 h, it can take place after the development operations and pumping tests, as long as a clay plug has been placed above the gravel filter.

## 7 Development

The development of a borehole is a very important step, which removes the majority of fine particles from the aquifer and gravel pack that have entered the borehole, as well as the remaining drilling-mud cake, and sorts the aquifer around the screen in order to increase its permeability.

This operation allows borehole yield to be increased significantly. The aquifer is progressively brought into production and freed from fine particles, with a consequent increase in permeability and water flow.

As the maximum yield of a borehole in use should be around two thirds of the yield obtained at the end of the development process, it is important to estimate maximum yield during development. If the yield during use is higher than the maximum obtained during development, there is a danger of drawing fine material into the borehole and damaging the pump.

### Box 8.6

#### Self-development of the aquifer.

An aquifer put into production via a borehole is automatically developed by pumping.

Lowering of the water table is a maximum at the borehole, but decreases with distance from the borehole axis, forming a depression cone. The size of this cone depends on the nature of the ground and the supply of the aquifer or its limits, as well as on pumping time and flow.

It has been demonstrated that the speed of the water decreases with distance from the borehole (according to Darcy's law) and therefore that the materials around the borehole are sorted under the influence of the pumping. The coarser materials settle around the screen, and the finer ones settle at the limit of the area affected. Fine particles are therefore drawn into the screen over time by a slow process which causes pumps to deteriorate.

'Sand bridges' are also formed, fine materials which accumulate under the effect of the flow. To break them, it is necessary to reverse the flow, through the development operation, which involves causing suction followed by pressure (Figure 8.25B).

## 7.1 Borehole cleaning

In rotary drilling using mud, cleaning consists of washing the sides of the borehole with clear water to eliminate the cake. It is best to make the drilling mud as thin as possible without risking a collapse of the borehole, at the end of the drilling phase, before casing. Once the casing has been introduced, the injection of clean water from the surface thoroughly rinses the screen and the gravel pack blocked with drilling mud. The phases of rinsing and air-lift pumping are alternated in the borehole until clear water emerges.

DTH-hammer drilling does not seal the aquifer. On the contrary, the borehole is developed by successive blowing while it is being drilled. However, it is still possible to suck in a great deal of sand, damaging the pumping equipment and causing the ground around the screen to sink. It is therefore necessary to carry out the development of the borehole.

## 7.2 Development processes

### 7.2.1 AIR-LIFT DEVELOPMENT

Air-lift development is the most effective and widely used process of development. Its main advantage is avoiding damaging pumps with sand. At the intake level, quite strong pressure and suction forces are created by the introduction of large volumes of air. Through alternate phases of air-lift pumping and direct blowing of air at the screen level, sand bridges are destroyed. Air lift is the most effective development technique for destroying sand bridges.

In practice, two pipes are introduced in the borehole (Figure 8.24):

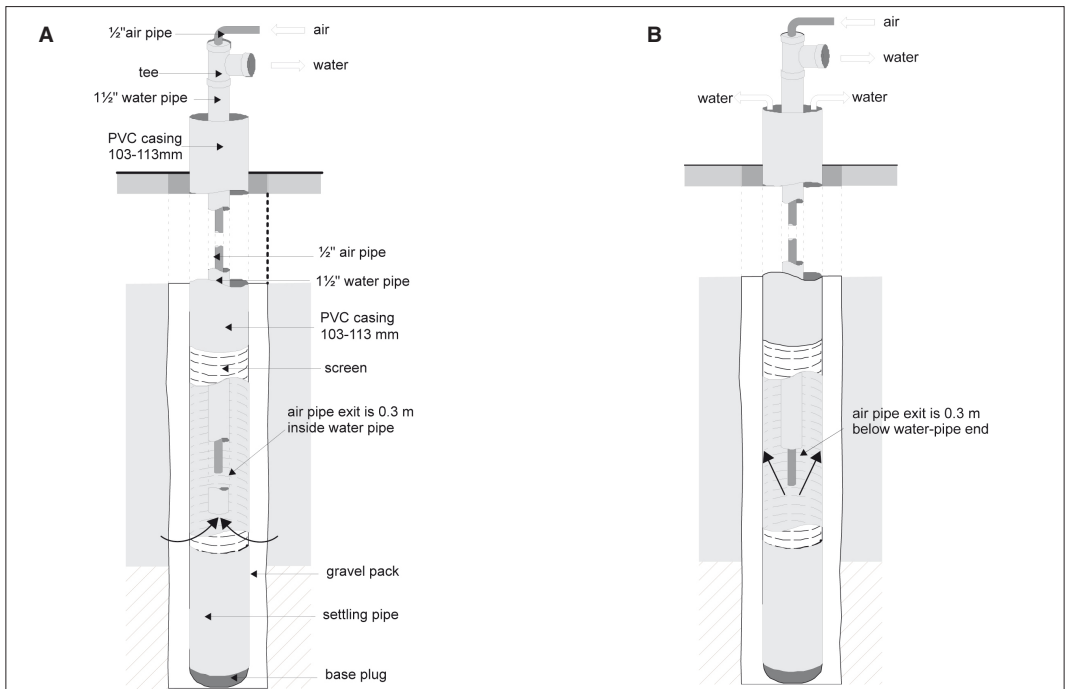
- a 1 1/2" PVC or G.I. pipe, called the water pipe, through which the pumped water returns to the surface;

- a polyethylene pipe with a smaller diameter, mounted on a drum and called the air pipe, introduced into the water pipe, which allows compressed air to be injected. Depending on its position inside the water pipe, it pumps water out of the borehole water, or blows on the inside the casing.

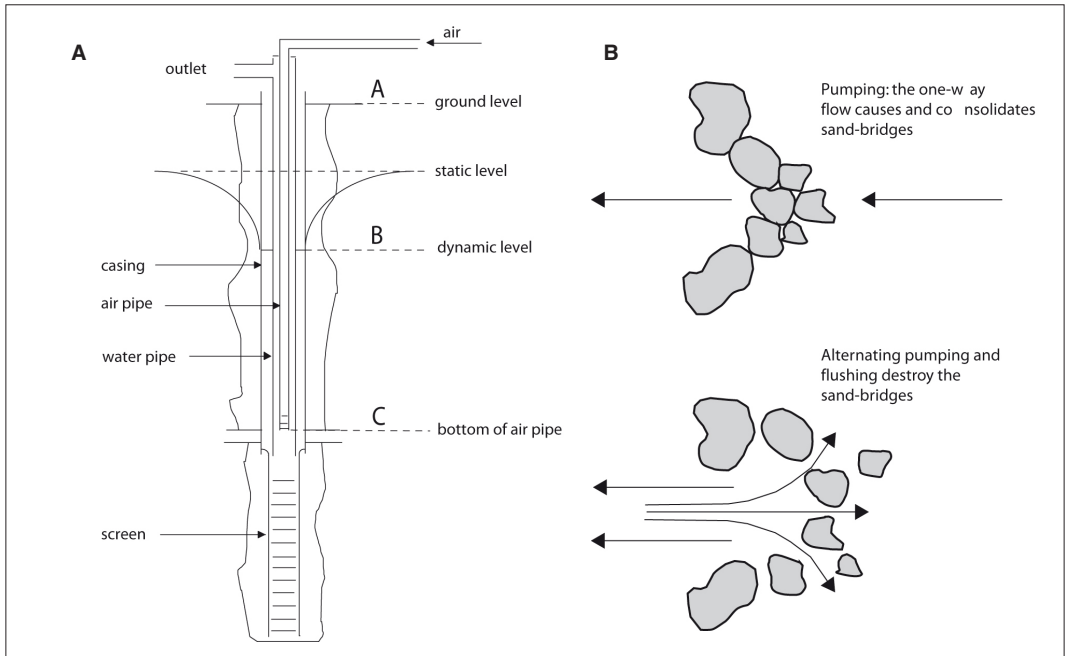
The different phases of development are given in Table 8.XXI. The method consists of blowing from the base of the borehole, in successive phases, to just above the screen. Development is not finished until the water coming out of the borehole is perfectly clear: this operation can last for several hours, and sometimes more than one day. To verify whether the water is clear, it should be collected in buckets and checked for any suspended matter (bucket or stain test). By spinning the water one can observe the suspended particles concentrated in the centre of the bucket. If the circle created is as big as a coin then the development must be continued.

**Table 8.XXI: Air-lift development process.**

Pumping	<p>Lower the water pipe foot to about 0.6 m from the borehole bottom</p> <p>Introduce the air pipe into the water pipe, locking with a self-grip wrench when its bottom end is about 0.3 m above the bottom of the water pipe (pumping position)</p> <p>Install a tee at the exit of the water pipe to channel the jet</p> <p>Ensure a seal between the two pipes with a rag or a piece of rubber compressed by the weight of the air pipe</p> <p>Open the air valve and let the pumped water flow until it is clear</p>
Blowing	<p>Shut off the air and lower the bottom end of the air pipe to about 0.3 m below the bottom end of the water pipe, i.e. 0.6 m lower than previously (air-cleaning position)</p> <p>Open the air valve, which expels the water contained in the casing</p> <p>Close and reopen the air valve sharply and repeatedly</p>
Pumping	<p>Raise the air pipe 0.3 m inside the water pipe: eject very cloudy water (reversal of flow with consequent turbulence around the screen)</p>
Renewal	<p>Clarify the water, raise water pipe by 1 m and restart operations (alternating pumping and blowing) up all the height of the screen</p> <p>Restart from the base, and continue the process until the water is totally clear</p>
Cleaning the casing	<p>Once above the screen, lower the device to the bottom of the borehole and pump out the sand deposited there</p>
Borehole plugged by clay or bentonite	<p>Position the pipes at the bottom of the borehole, in blowing position (air pipe below water pipe)</p> <p>Connect the mud-pump delivery pipe to the water pipe</p> <p>Pump air and clean water into the borehole at the same time that the air is being blown</p> <p>The flow created rinses the borehole: the water descends through the water pipe and returns through the casing</p>



**Figure 8.24: Air-lift development.**  
**A: pumping phase. B: blowing phase.**



**Figure 8.25: Air-lift.**  
**A: design. B: sand-bridge destruction.**

For small-diameter boreholes (1½" or 2"), a simple blowing test allows the presence or absence of water to be confirmed.

*Note.* – If the water column isn't high enough then the air-lift won't be able to elevate the water, for physical reasons. Approximately, the system will function efficiently if  $BC \geq 0.60 \times AC$  (Figure 8.25A).

### 7.2.2 OTHER DEVELOPMENT TECHNIQUES

Other development techniques can be used, depending on the characteristics of the boreholes and the equipment available. These different methods can be also combined with each other:

- *Over-pumping*: this is the easiest method and consists of pumping at a higher rate than the planned exploitation yield. It complements the air-lift method and is necessary when the planned abstraction rate is greater than the one obtained by air-lift. This method can also be coupled with the 'alternating pumping' or 'pistoning' (surging) methods. Used alone, it has no effect on sand-bridges.

- *Alternating pumping*: the objective is to create pressure variations within the installation by alternating phases of pumping and resting. A high pressure is created by the water column falling down in the rising main when the pumping stops.

- *Pistoning*: this consists of moving a piston vertically within the casing to create, alternately, suction (water and fines move from the aquifer to inside the casing) and compression (water and fines are pushed out of the casing); this destroys sand-bridges. The borehole can be emptied with a bailer or scoop.

- *Pressurised washing*: this consists of injecting pressurised water within the borehole. It can be useful and fast especially in sandstone formations where the drilling operation often obstructs the porosity. This cheap method can be coupled with the action of chemicals for cleaning the borehole and its surroundings (see Chapter 8B).

### 7.2.3 PUMPING

Carrying out pumping tests (see Chapter 6) after development with air lift generally allows the development of the borehole to be completed, through alternating pumping (see Section 7.2.2).

*Note.* – The yield of the pumping test must be higher than the planned exploitation yield.

## 7.3 Instantaneous flow

The characteristics of the aquifer are defined by long-term pumping tests, which are usually difficult to carry out. When equipped with non-motorised pumps, the characteristics of the borehole are determined by pumping tests in flow steps, which are easier to carry out in ACF programmes (see Chapter 6).

In order to prepare the pumping test steps, the instantaneous flow of the borehole and corresponding drop in water level are measured at the end of development:

- the flow is estimated when the air-lift device is in pumping position (note: the size of the device influences the flow of water blown);
- then the water level is lowered (avoiding de-watering the borehole), and a fairly long period is allowed for the flow to stabilise;
- finally, the flow (time to fill a 20 l bucket) and the corresponding lowering of water level are measured.

## 8 Monitoring and borehole report

Monitoring borehole construction does not necessarily have to be carried out by a hydrogeologist. Experience has shown that a rigorous site manager can very well be in charge of this job after a training period with the hydrogeologist responsible for the borehole programme. Afterwards, the site manager technician will regularly (daily, by radio if necessary) provide the hydrogeologist with all the major information and important decisions taken during the drilling process. The monitoring cards and borehole report are given in Annexes 11B to D.

All information related to the borehole must be noted:

- name of the site or village, GPS coordinates whenever possible;
- working dates, starting, stopping and restarting times;
- name of the drilling firm and, where necessary, of the driller;
- time counters of the machines (compressor, engine);
- technique used, progress by drill pipe or metre, drill-pipe addition;
- any major incidents or important operations such as pulling up a drill string, stopping machinery, equipping the borehole;
- estimated yield and drawdown through development
- casing plan, with the exact lengths of casing and screen, their diameters, the position of the gravel pack, clay and cement plugs.

Essential geological information is also included, e.g. nature of the ground drilled, signs of water and flow estimated after each ingress of water. Finally, the driller keeps an up-to-date log book which collates all information on consumption of materials (cement, casing, bentonite), fuel and lubricants, machinery maintenance, mechanical problems encountered, and their solutions.

When the borehole is completed, essential information is summarised in the borehole report, whether the borehole is dry or wet. The hydrogeologist in charge is responsible for writing this document. These reports are an invaluable source of information for the project, and also provide a hydrogeological data bank. They must therefore be centralised at project level and also delivered to the relevant local authorities, who may, in certain cases, recommend a common approach for all organisations involved in the same area.

These reports are filed with all the technical information on the water point: field surveys, data and interpretations of geophysical exploration tests, pumping-test data, site plan etc.

## 9 Surface works

An example of a borehole equipped with a handpump is given in Figure 8.26. Construction details are given in Annex 14.

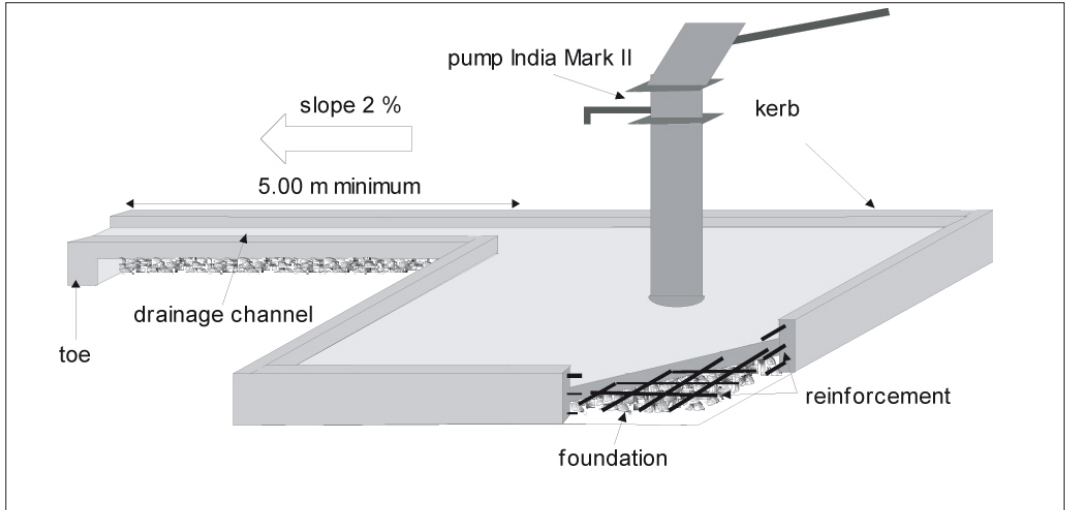


Figure 8.26: Borehole surface works (ACF, Kampala, Uganda, 1996).



# B BOREHOLE REHABILITATION

---

<b>1</b>	<b>Introduction</b>	307	<b>3</b>	<b>Diagnosis</b>	309
<b>2</b>	<b>Description of the causes of borehole deterioration</b>	307	3.1	Methodology	309
2.1	Electrochemical and bacterial corrosion	308	3.2	Data analysis	310
2.2	Mechanical, chemical and biological clogging	308	<b>4</b>	<b>Intervention techniques</b>	310
2.2.1	<i>Mechanical clogging</i>	308	4.1	Development	312
2.2.2	<i>Chemical clogging</i>	309	4.2	Bailing and over-drilling	312
2.2.3	<i>Biological clogging</i>	309	4.3	Re-equipment	312
2.3	Erosion	309	4.4	Unclogging	312
			4.5	Rehabilitation of surface works	313
			<b>5</b>	<b>Preventive maintenance</b>	314
			<b>6</b>	<b>Condemning a borehole</b>	314

---

## 1 Introduction

A borehole is a structure that is submitted to physical, chemical and biological processes that depend on the quality of its construction, the way it is operated and the characteristics of the aquifer. The deterioration of a borehole is unavoidable but its intensity and its velocity will depend on the above factors and will be characterised by decreasing productivity (falling ratio of yield to draw-down) and water quality. It can lead to the borehole being abandoned. In many cases rehabilitation can reduce the deterioration or successfully repair the borehole.

Rehabilitating a borehole can be more economical than constructing a new one. It is simpler and faster, and can be an appropriate solution in an emergency situation (it doesn't require the mobilisation of a drilling rig); however if the rehabilitated borehole is to be used for a long time, it is important to estimate its life expectancy (the rehabilitation of damaged boreholes is not necessarily a long term solution).

In practice the need to rehabilitate a borehole arises when:

- a functioning borehole presents usage problems (low productivity, contamination of the water);
- carrying out a borehole programme (rehabilitation and drilling new boreholes are usually complementary); and
- carrying out a pump-maintenance project (small rehabilitation works, such as development, are often carried out at the same time).

The rehabilitation option chosen depends on the conditions of the existing borehole, the causes of the damage, the technical and logistic options, the existing alternatives (construction of other water points) and the opinion of the users (consumers and operators).

According to the severity of the borehole problems, the work required may vary from a simple repair at the surface to unclogging operations or re-equipment.

## 2 Description of the causes of borehole deterioration

The problems found depend on the age of the borehole, the quality of its construction, the way it has been used and the geological context (Table 8.XXII).

**Table 8.XXII: Common problems and frequency of occurrence according to the geological context.**

Aquifer	Frequent problems	Frequency of occurrence (frequency of maintenance required)
Alluvia	Clay-sand clogging Iron precipitation Incrustation Biological clogging	2 to 8 years
Sandstone	Clogging of the fissures Corrosion Sand intrusion and silting up	6 to 10 years
Calcaneous	Clogging by clays Precipitation of carbonates	6 to 12 years
Basalts	Clogging by clays	6 to 12 years
Metamorphic	Clogging by clays Mineralisation of the fissures	12 to 15 years

## 2.1 Electrochemical and bacterial corrosion

Corrosion is a chemical phenomenon that tends to destroy a material in a medium with which it is not in equilibrium. Metallic pipes are unstable in water and will corrode because of migration of positive ions from the metal into the water. Certain chemical reactions are frequently catalysed by bacterial activity.

In boreholes, corrosion may affect all the metallic and non-metallic parts (such as reinforced concrete and mortar). Only the plastics, the bituminous facing, and the stainless steel parts are not susceptible.

## 2.2 Mechanical, chemical and biological clogging

Clogging is a mechanical, chemical or biological phenomenon that causes a reduction in the permeability of the medium and increases the head-losses at the intake level. Chemical and biological clogging is directly related to corrosion phenomena.

The clogging of a borehole reduces its performance. It is accompanied by deposits whose nature is related to the type of clogging.

### 2.2.1 MECHANICAL CLOGGING

This consists of:

- *Sand intrusion and silting up*: a significant entry of fine materials into the borehole which may extend to the partial filling of the intake section. This is caused by poor installation of the borehole (screens not properly centred, gravel not properly distributed, large gravel pack grains and oversized slots), inappropriate operation of the borehole (insufficient development, an exploitation yield larger than the yield determined by the pumping test, dewatering of screens), wearing out (or breaking) of the screens or of other pipes.

- *Clogging of the gravel pack*: accumulation of materials on the outside of the gravel pack (external clogging due to suspended matter larger than the pores of the gravel pack), or on the inside (internal clogging of a gravel pack by layered grains due to suspended matter larger than certain pores of the gravel pack). This type of clogging is caused by an insufficient development, by over-pumping or by a gravel pack of bad quality (inhomogeneous grain size, gravel that is too angular etc.).

## 2.2.2 CHEMICAL CLOGGING

This consists of the precipitation of insoluble salts that obstructs the slots of the screens. It is caused essentially by the dewatering of the screen and provokes:

- *incrustation or scaling*: precipitation of carbonates by degassing of CO<sub>2</sub>.
- *iron deposits*: precipitation of iron (II) hydroxides (Fe(OH)<sub>2</sub>) due to the degassing of CO<sub>2</sub> or precipitation of iron (III) hydroxides (Fe(OH)<sub>3</sub>) by addition of oxygen.

## 2.2.3 BIOLOGICAL CLOGGING

This type of clogging develops more often in alluvial or shallow layers and is caused by the development of bacteria that creates a compact sticky film that obstructs the screen slots.

Bacterial clogging may be caused by natural changes (e.g. drought, or flooding with nutrient-rich surface water) and by man-made changes (organic pollution, raised water table due to the construction of dams). They are also a consequence of screen-dewatering. However, iron and manganese bacteria are often naturally present in the water and soils, and develop significantly after the changes brought about by the borehole, namely the addition of nutrients brought in by the water during pumping.

The development of bacteria, and hence clogging, that may follow concern the gravel pack, the screen and also the surrounding formations within an area of several meters.

## 2.3 Erosion

Wearing out of the screen may occur by abrasion when the entry velocity of the water is very high (over 3 cm/s). This is essentially due to a insufficient open area of the screen (incorrect relations between slot openings, grain size of the gravel pack and grain size of the aquifer), an insufficient screen length or incorrect positioning of the pump within the screen (high water velocity at the level of the pump and vibration of the pump when it starts, thereby colliding against the screen).

# 3 Diagnosis

The diagnosis of the borehole is the first step in a rehabilitation programme and must be carried out with care. The objective is to analyse the degradation that affects the correct functioning of the borehole in order to understand the causes and to estimate the relevance of proceeding with rehabilitation.

## 3.1 Methodology

The different steps of diagnosis are described below:

### 1) Preliminary information collection

This determines the characteristics of the borehole when it was commissioned and how it has been used:

- review of the *borehole log sheet*: date of construction, geological conditions, drilling technique, problems at the time of drilling, casing plan (to check the position and type of screen), nature and positioning of the gravel pack, technique of development used and results of the pumping test and water analysis;
- general information *from operators and users*: depth of the pump installation, yields and time schedule of pumping, change of the performance of the borehole and of the quality of the pumped water (including taste, odour and colour);
- in case of *abandonment*: research into the cause and date of abandonment.

This data is not always easy to obtain, but a rapid examination of the borehole allows the preliminary information to be complemented (and verified).

## 2) *Rapid examination*

Several elements may be swiftly verified:

- Condition of the equipment and depth of pump installation.
- Quality of the water:
  - turbidity;
  - faecal contamination;
  - conductivity;
  - taste, odour, colour;
  - presence of sediments (bucket test, see Chapter 8A, Section 7.2.1).
- Analysis of the borehole:
  - lowering of the static level;
  - decrease in borehole depth;
  - decrease in performance (estimation of the yield and of the water level during pumping).
- State of the surface works.

This field information and its comparison with the initial data on the borehole allow a rapid initial diagnosis of the borehole condition and actions to be taken.

At this stage, the necessity to proceed with an in-depth diagnosis must be questioned and justified, because the work involved is costly and time-consuming, requiring highly specialised and expensive instruments, laboratory analyses, and mobilisation of human and material resources. The decision will be taken according to the cost and feasibility of the operations to be undertaken and after considering the relevance of rehabilitation rather than other alternatives.

## 3) *Use of inspection tools*

The most commonly used tools are *video cameras* (only used in clear water), that allow the detection of zones where pipes are damaged and where screens are clogged, as well as the presence of *incrustations*, and *diagraphy*<sup>\*</sup>, that allows an estimation of the pipe condition, of the cementation and, in certain contexts, of the aquifer.

*Note.* – In the absence of data about the borehole, it is important to identify where the screen is positioned, since this constrains the installation of the pump, the determination of the exploitation yield and the development process. The utilisation of diagraphy or a video camera allows this to be determined.

## 4) *Pumping test and water analysis*

A pumping test allows precise measurement of the hydrodynamic parameters of the borehole and calculation of head-losses, to determine the efficiency of the borehole (see Chapter 6).

In parallel with the pumping test, it is important to perform a water analysis as complete as possible, including nature and size of the suspended particles and physicochemical analyses (see Chapter 4).

## 3.2 Data analysis

Table 8.XXIII summarises the data to collect and analyse, and the corresponding activities to plan, when designing a rehabilitation operation.

## 4 Intervention techniques

Once the diagnosis is ready, it is necessary to estimate the feasibility and cost of the rehabilitation. The decision to rehabilitate or abandon the borehole must be taken in view of what the rehabilitation involves and the alternatives are.

---

\* *Diagraphy*: recording of physical parameters, established by survey techniques, that enable the production of information on the nature and structure of rocks and their contents.

**Table 8.XXIII: Analysis, diagnosis and techniques for borehole rehabilitation.**

Data	Diagnosis	Rehabilitation techniques
<b>ANALYSIS OF YIELD AND LEVELS (PUMPING TESTS)</b>		
Decrease of the borehole depth	Sand intrusion	<i>Analysis of deposits to finalise the diagnosis</i>
Decrease of specific yield (yield / dynamic level)	Clogging Sand intrusion	<i>Analysis of deposits to finalise the diagnosis</i>
Lowering of the static level	Aquifer drying up (long-term trend or seasonal fluctuation)	<i>If the aquifer allows:</i> Reinstallation of the pump (depth and/or model) Over-drilling and re-equipment or abandoning
Calculation of the quadratic head-losses (C) in m/m <sup>3</sup> /s:	<i>These values must be considered as orders of magnitude and they will only make sense when compared with each other</i>	<i>Analysis of deposits to finalise the diagnosis</i>
→ C < 5 x 10 <sup>-3</sup>	There is no clogging	
→ 5 x 10 <sup>-3</sup> < C < 1 x 10 <sup>-4</sup>	Possible clogging	
→ 1 x 10 <sup>-4</sup> < C < 4 x 10 <sup>-4</sup>	Clogged well	
→ C > 4 x 10 <sup>-4</sup>	Unrecoverable well	
<b>WATER ANALYSIS</b>		
Conductivity increase	Perforation of the pipes	Re-equipment or abandoning
Modification of a parameter: temperature, sulphate, nitrate etc.	Cementation fault	Re-do the cementation
Increasing bacterial presence	Corrosion	Re-equipment or abandoning
High turbidity	Incorrect equipment Perforation of the pipe	<i>Analysis of deposits to finalise the diagnosis</i>
Faecal contamination	Problem on the superstructure Grouting/concreting fault	Rehabilitation of surface works
<b>ANALYSIS OF DEPOSITS</b>		
Sand of diameter smaller than the screen slots	Incorrect development Incorrect equipment	Bailing and development Bailing and re-equipment
Sand of diameter larger than the slots of the screen	Wearing/rupture of the screen Rupture of the casing	Bailing and re-equipment or abandoning
Presence of calcites in the form of grains or flakes	Scaling by precipitation of calcite (may be accompanied by corrosion)	See Section 4.4
Presence of iron in the form of oxide	Corrosion of the screens (may be accompanied by clogging, precipitation of iron)	Re-equipment <i>The methodology for protection against corrosion is difficult to be used in humanitarian intervention contexts</i>
Presence of gels, mud, flocs and smells	Clogging due to bacteria (may be accompanied by corrosion)	See Section 4.4
<b>DIAGRAPHY</b>		
Video camera	Clogging Rupture of the casing	See Section 4.4 Re-equipment or abandoning
Acoustic images	Scaling Corrosion	See Section 4.4 Re-equipment or abandoning
<i>Electric log allows determination of the casing plan (positioning of the screens)</i>		

## 4.1 Development

Development is done at the beginning and at the end of each rehabilitation. It allows the borehole to be cleaned, certain clogging problems to be solved, and the efficiency of the rehabilitation work to be evaluated. The best techniques are air-lift, pistoning (surging) and jetting, see Chapter 8A Section 7.

## 4.2 Bailing and over-drilling

The bailing operation aims to remove all the accumulated deposits at the bottom of the borehole that can't be extracted by development (clay, sand, rock debris etc.). The operation consists of lowering a bailer into the borehole, that will trap the materials with a flap-valve system. It is a dangerous process for the casing.

Over-drilling is used if the borehole is filled with materials that cannot be removed by bailing. The technique used depends on whether or not the borehole has a screen.

If the borehole has no screen, drilling is performed inside the borehole with a diameter smaller or identical to the initial one. If the borehole is blocked by large-diameter debris, it is possible to drill by cable-tool or down-the-hole hammer (DTH).

If the borehole has a screen, it is necessary to drill (rotary or cable-tool) with a small diameter inside the existing borehole. A low progression velocity is used in order to extract all of the sediments. These operations damage the casing and screen, and it is often necessary to re-equip the borehole.

## 4.3 Re-equipment

Re-equipment consists of placing new casing inside the existing one. The new casing has a diameter at least 4 to 6 centimetres less than the existing one, to allow installation of a sufficiently thick gravel pack.

This operation reduces the diameter of the borehole and increases the head-losses (creation of new interfaces with the aquifer). Grouting is done as for a new borehole.

## 4.4 Unclogging

Development may partially solve certain clogging problems, but nevertheless, chemical treatments are often required (treatment with acids or with chlorine). In general, for various reasons, it will be necessary to use different solutions (mixed treatment), see Table 8.XXIV.

**Table 8.XXIV: Treatments for clogged boreholes.**

Treatment with acids	Treatment with polyphosphates	Treatment with chlorine	Development
↓	↓	↓	↓
Deposits of carbonates and sulphates	Precipitation of compounds of iron and manganese	Clogging by matter created by bacteria (bio-fouling)	Clogging by fines

The principle is to introduce into the borehole a solution that will act upon the screen, the gravel pack and the surrounding aquifer, for a certain time. During a contact period the water is agitated in order to improve the efficiency of the treatment. At the end of the treatment a long pumping step is performed in order to eliminate all traces of the chemical product used. The process is summarised in Table 8.XXV.

**Table 8.XXV: Chemical treatment process.**

Steps	Treatment with acids	Treatment with polyphosphates	Treatment with chlorine
Measure initial pH	X	X	
Prepare the stock solution (1.5 to 2 times the volume of the screen)	X	X	X
Pour the solution into the borehole via a PVC pipe (one half at the top part of the screen and one half at the bottom part)	X	X	X
Agitate the solution for 2 hours by blowing	X		
Perform a development process (air-lift or piston) for 12 to 24 hours		X	X
Pump in order to remove all the chemical products	X	X	X
Check that the water returns to the initial pH or residual chlorine level	X	X	
Measure the residual chlorine level			X

#### *Treatment with acids*

The acids normally used are *hydrochloric acid* and *sulphamic acid*. Note that hydrochloric acid is strongly advised against for metallic screens (namely zinc and galvanised steel). Furthermore, sulphamic acid is normally more efficient than hydrochloric acid.

For hydrochloric acid, the form commonly used is a 30% w/w. Sulphamic acid, which is sold as a solid in crystals, needs to be dissolved in water (at 15°C: 200 grams of crystals for 1 litre of water; at 30°C: 260 g of crystals for 1 litre of water).

*Note.* – Acids must be used with extreme care (gloves, appropriate clothes, glasses, mask) and according to local regulations.

#### *Treatment with polyphosphates*

Polyphosphates used are derived from sodium phosphates in solid or dust form. The dose is 2 to 4 kg of product in 100 litres of water. Note that it is effective to add chlorine to the polyphosphate solution, at the rate of 120 to 150 grams of HTH per 100 litres of water, in order to combine the effects of both products.

#### *Treatment with chlorine*

The concentrations of these products range from 1 000 to 2 000 mg/l of active chlorine, and the volumes of solutions used depend on the volume of water to be treated in the aquifer. It is assumed that this volume is at least 5 times higher than the volume of the water in the borehole. The chlorine products and the water to be treated must be thoroughly mixed and there must be a minimum contact time of 12 hours.

## 4.5 Rehabilitation of surface works

The rehabilitation of surface works may be considered if they are in bad condition or were poorly constructed. Depending on their condition, it may be better to destroy them than to repair them – a new layer of concrete over a structure that is not in a proper condition is not solid and will be deteriorated very fast. If repairs are carried out to concrete structures, the surface to be repaired should be roughened to ensure cohesion, and holes should be made to anchor new mortar or concrete.

Rehabilitation is done according to normal procedures for constructing borehole surface works (see Chapter 8A, Section 9), taking into consideration the causes of the observed deterioration (natural erosion, animal or human wear and tear, unsuitability to the needs and habits of the population etc.).

## 5 Preventive maintenance

It is preferable to prevent the problems of ageing in order to retard the deterioration of boreholes. In addition to the issues concerning the construction of the borehole (choice of materials, positioning of the pipes, quality of grouting), reasonable use and regular maintenance diminish and minimize the problems of deterioration:

### *Use*

In order to obtain maximum longevity and to retard the appearance of ageing phenomena, it is necessary to follow the following rules:

- Avoid frequent start-ups and continuous pumping 24h/24.
- Do not exceed the maximum exploitation yield.
- Do not decrease the water level below the top of the screen.
- Periodical maintenance and monitoring: maintenance of the pumping system and of the surface works.
- Annually: complete analysis of the water (bacteriological and physicochemical), monitoring of the pumping system.
- Every 3 to 5 years: a pumping test, withdrawal and complete inspection of the rising main and measurement of the total depth of the borehole.

## 6 Condemning a borehole

When the rehabilitation of a borehole is not feasible (for technical or economic reasons), it is necessary to block it in an impermeable manner in order to avoid any contamination of the aquifer. In order to achieve this it is necessary to plug the whole of the borehole column (not only at the surface) with cement grout. In order to guarantee its integrity, and hence its impermeability, the grout must be poured through a pipe, starting at the bottom of the borehole and withdrawing the pipe gradually as work proceeds, rather than simply pouring it in at the top of the borehole and allowing it to fall to the bottom. This technique should be also used to condemn a new negative borehole (non exploitable) that has penetrated the aquifer zone.

*Note.* – The decision to condemn a borehole permanently should not be taken only on the basis of current conditions, but should also take into consideration the technical and financial possibilities of rehabilitation in the future. In particular, deep boreholes or boreholes in isolated areas should not be condemned without a lot of thought. In any case, this operation must not be done without the full agreement of the users and operators.



# C FIELD EXAMPLES

<b>1</b>	<b>Planning a drilling programme</b>	315	<b>3</b>	<b>Overview of selected programmes</b>	319
<b>2</b>	<b>Resources to be mobilised</b>	316	3.1	Non-consolidated sedimentary area	319
2.1	Human resources	316	3.2	Bedrock area	322
2.2	Drilling costs	316			

## 1 Planning a drilling programme

Creating a borehole involves siting the borehole, drilling and equipping the borehole, constructing the surface works, pumping tests and pump installation.

Depending on the context, more or less time will be devoted to groundwater prospecting and siting of the borehole, and the percentage of positive boreholes which may be equipped with hand-pumps will vary. A success rate of 75 to 80% is the optimum level to be reached in a bedrock context.

When higher yields are sought (more than 3 m<sup>3</sup>/h), the prospecting studies are more thorough and are complemented by drilling exploration boreholes (see Chapter 5).

The time required for drilling a borehole depends on several factors apart from its depth and diameter, such as the drilling technique and the rig used, geological conditions (ease of removal of cuttings, stability of the borehole sides), and technical problems with the drilling rig. Experience shows that on average about one week is necessary to complete a borehole.

The timetables of the exploration teams and the surface-works construction team are based on the progress of the drilling team. Likewise, the timetable of the drilling team must take account of the preparatory work carried out by the hygiene education team. A timetable similar to the one shown in Table 8XXVI, extrapolated to the duration of the programme, can be used to plan the activities involved.

During the rainy season, when access to sites is usually limited, and geo-electrical tests are difficult to carry out, it is advisable to stop drilling and make use of the time to repair and maintain the equipment.

**Table 8 XXVI: Borehole-drilling plan.**

Days	1	2	3	4	5	6	7	8	9	10	11	12	13
TEAM 1 (geophysical exploration)	.....												
TEAM 2 (drilling and equipment, cleaning and development)			.....										
TEAM 3 (pumping test, water analysis, test interpretation)								.....					
TEAM 4 (surface works, pump installation)											.....		

## 2 Resources to be mobilised

### 2.1 Human resources

Human resources required are listed in Table 8.XXVII.

**Table 8.XXVII: Personnel necessary for drilling a borehole.**

---

<b>MANAGEMENT</b>	
1 hydrogeologist project manager	Borehole siting, team management Contacts with the local partners
1 logistician	Supplies to the sites
<b>PROSPECTION TEAM</b>	
1 geophysics technician	Tests and their interpretation
3 assistants	Test preparation
<b>DRILLING TEAM</b>	
1 driller	Managing borehole drilling and equipping (casing plan), report writing
1 mechanic	Maintenance of drilling rig and compressor
4 labourers	Site installation, pit cleaning, drill-pipe changing, water supply, borehole equipping etc.
<b>SURFACE-WORKS TEAM</b>	
1 builder	Site manager, supervision of construction of apron
1 pump technician	Pump installation, borehole disinfection
3 labourers	Reinforcement, concrete mixing etc.

---

### 2.2 Drilling costs

The cost of a borehole depends on numerous factors: depth and diameter, type of drilling rig used, price of consumables etc., but also on the method used for calculating costs. The costs of consumables for a borehole in East Africa are listed in Tables 8.XXVIII A and B, and Table 8.XXIX shows the total cost of a borehole in South-East Asia. The cost of the work is clearly lower in Asia, because the consumables are less expensive, although the estimation methods are also different. When talking of drilling costs, especially to compare different areas or different agencies, it is necessary to know what is being assessed: only consumables, logistics, human resources, depreciation of the equipment etc.

**Table 8.XXVIII A: Example of cost of a borehole in Uganda (ACF, 1997).  
Depth 50 m, rotary drilling 8”1/2 and then 6” DTH hammer (ACF-PAT 301).**

Items	Quantity	Unit cost (US\$)	Total cost (US\$)
<i>Borehole</i>			
PVC 103 x 113 mm (2.9 m) casing	13	12	156
PVC 103 x 113 mm (2.9 m) screen	6	18	108
PVC 167 x 180 mm (2 m) pre-casing	10	27	270
base plug	1	6	6
filter gravel (l)	600	0.05	30
diesel (l)	500	1	500
petrol (l)	150	1	150
polycol (kg)	10	10	100
drilling foam (l)	20	5	100
drilling oil (l)	5	5	25
grease (l)	10	5	50
<i>2.5 x 2.5 m apron</i>			
cement (50-kg bag)	12	12	144
sand (m <sup>3</sup> )	0.6	12	7.2
gravel (m <sup>3</sup> )	0.3	30	9
stone (m <sup>3</sup> )	3	15	45
weld-mesh (m <sup>2</sup> )	6	3.5	21
<i>3 x 3 m washing area</i>			
cement (50-kg bag)	14	12	168
sand (m <sup>3</sup> )	2	12	24
gravel (m <sup>3</sup> )	1	30	30
stone (m <sup>3</sup> )	3	15	45
weld-mesh (m <sup>2</sup> )	9	4	36
<i>Pumping test</i>			
petrol (l)	50	1	50
bacteriological water analysis	20	5	100
physicochemical analysis	10	10	100
<i>Pump</i>			
U2 (India Mark II) pump	1 000	1	1 000
<i>Depreciation of the equipment</i>			
ACF-PAT 301	1	800	800
<b>TOTAL</b>			<b>4 074</b>

**Table 8.XXVIII B: Example of cost of a borehole in Liberia (ACF, 2003).****Depth 35 m, rotary drilling 8”1/2 and then 6” DTH hammer (ACF-PAT 301). Duration of task: 1 week including development and handpump installation.**

Items	Quantity	Unit cost (US\$)	Total cost (US\$)
<i>Borehole</i>			
PVC screen 2 m x 125 mm slot 1 mm	3	20	60
PVC casing 125 mm x 2 m	10	15	150
PVC casing 125 mm x 1 m	2	8	16
PVC pre-casing 6m x 150 mm	3	33	99
base plug	1	5	5
PVC glue (can 500 ml)	1	30	30
filter gravel (50 kg)	23	1	23
polycol (50 kg)	1	50	50
diesel for compressor (gallon)	40	3	120
petrol (gallon)	15	3	45
<i>Apron</i>			
cement (50 kg-bag)	14	7	98
sand (ton)	2	10	20
gravel (m <sup>3</sup> )	0.3	30	9
stone (m <sup>3</sup> )	3	15	45
reinforcement bars 3 m x 6 mm	10	2	20
<i>Pump</i>			
Afridev (15 m depth)	1	500	500
<i>Depreciation of the equipment</i>			
ACF-PAT 301	1	500	500
<i>Drilling team</i>			
(a drilling coordinator supervises the different machines)			
drilling supervisor	1	70*	70
mechanical drilling assistant	1	40	40
drilling technician	3	30	90
labourers	3	20	60
<i>Apron construction</i>			
supervisor	1	70	70
mason	2	30	60
TOTAL			2 110

\* Cost per borehole for 1 week of work.

**Table 8.XXIX: Example of cost of a borehole in Cambodia (ACF, 2003).  
Depth 56 m, 6”1/2 (ACF-PAT 301).**

	Unit cost (US\$)
56 m borehole, fully equipped	590
Apron	238
Afridev pump	390
ACF-PAT 301spares	300
Depreciation of the ACF-PAT 301 drilling rig	120
Sub-total	<b>1 638</b>
Drilling team	90
Surface-works team	62
Hygiene-education team	180
Supervisor	48
Sub-total	<b>380</b>
ACF expatriate	212
Sub-total	<b>212</b>
4x4 vehicle	350
Truck rental	50
Sub-total	<b>400</b>
8% administrative charges	<b>216</b>
<b>TOTAL</b>	<b>2 846</b>

### 3 Overview of selected programmes

#### 3.1 Non-consolidated sedimentary area

The programme summarised in the following tables deals with a non-consolidated sedimentary area (sand and clay) in Central Africa. In this inaccessible context, light rotary drilling with an ACF-PAT 201 machine was chosen. The objective was to complete 40 boreholes of 40 m average depth using two rigs over a total period of 12 months:

- 1 month for purchase and transport of material;
- 1 month for organisation and training of teams;
- 8 months for drilling;
- 2 months for follow-up of water committees in charge of pump maintenance.

Table 8.XXX presents the total budget for the operation.

**Table 8.XXX: Total budget for an ACF-PAT 201 drilling programme (ACF, 1996).**

SUMMARY	Total amount (US\$)			
1. Local staff	65 600			
2. Equipment	96 282			
3. Logistics	95 064			
4. Administrative costs	4 000			
Grand total	260 946			

1. LOCAL STAFF	Number	Salary (US\$)	Duration (months)	Total (US\$)
Supervisor	1	800	12	9 600
Drilling team (2 groups)	10	200	10	20 000
Builder/pump technician (2 groups)	6	150	12	10 800
Geophysical team	4	150	10	6 000
Logistics	1	300	12	3 600
Community workers	5	100	12	6 000
Labourers	6	50	12	3 600
Others	5	100	12	6 000
Total	38			65 600

2. EQUIPMENT	Number	Total cost (US\$)	
Water equipment	1	45 400	
Tools and consumables	1	11 882	
Equipment for 40 boreholes	1	39 000	
Total		96 282	

3. LOGISTICS	Quantity /month	Unit cost (US\$)	Total (US\$)
Warehouse	2	3 000	6 000
Vehicle	24	2 400	57 600
Motor-cycle	3	1 938	5 814
Bicycle	3	100	300
Fuel and maintenance	24	400	9 600
International transport (tons)	3.5	4 500	15 750
Total			95 064

4. ADMINISTRATIVE COSTS	Duration (months)	Unit cost (US\$)	Total (US\$)
Educational materials	10	300	3 000
Communications costs	10	100	1 000
Total			4 000

Table 8.XXXI shows costs of drilling equipment.

Table 8.XXXII shows costs of consumables for 40 boreholes.

**Table 8.XXXI: Cost of drilling equipment.**

Description	Quantity	Unit cost (US\$)	Total (US\$)
Complete kit ACF-PAT201	2	10 500	21 000
Pumping-test kit	1	3 000	3 000
50 m water-level dipper	2	600	1 200
Water-analysis kit	1	1 000	1 000
Bacteriological-analysis kit	1	3 000	3 000
Conductivity meter	1	700	700
Ωmega+ resistivity meter	1	5 500	5 500
Computer	1	2 000	2 000
Motor-pump & accessories	1	3 000	3 000
Spares	1	5 000	5 000
<b>TOTAL</b>			<b>45 400</b>

**Table 8.XXXII: Costs of consumables for 40 boreholes.**

Description	Quantity	Unit cost (US\$)	Cost (US\$)
<i>Borehole</i>			
103x113 mm casing (10/borehole)	400	12	4 800
103x113 mm screen (4/borehole)	160	18	2 880
167x180 mm pre-casing (2/borehole)	80	27	2 160
filter gravel (600 l/borehole)	24 000	0.05	1 200
diesel (20 l/borehole)	800	0.85	680
petrol (30 l/borehole)	1 200	1	1 200
<i>Apron</i>			
cement (8 bags/borehole)	320	12	3 840
sand (0.5 m <sup>3</sup> /borehole)	20	12	240
bricks (500/borehole)	20 000	1	20 000
weld-mesh (1 sheet/borehole)	40	20	800
stone (2 m <sup>3</sup> /borehole)	80	15	1 200
handpump	40	donation	
<b>TOTAL</b>			<b>39 000</b>

## 3.2 Bedrock area

This example of a programme deals with the purchase of an ACF-PAT 301 drilling rig capable of drilling in rotary and in DTH-hammer mode in an African bedrock area. The 6-month project includes drilling 10 boreholes of an average depth of 50 m (Table 8.XXXIII to Table 8.XXXVI).

**Table 8.XXXIII: Total budget for an ACF-PAT 301 drilling programme.**

Summary	Total amount (US\$)			
1. Local staff	11 100			
3. Equipment	106 306			
4. Logistics	83 521			
5. Administrative costs	2 400			
<b>GRAND TOTAL</b>	<b>203 327</b>			

1. LOCAL STAFF	Number	Salary (US\$)	Duration (months)	Total (US\$)
Supervisor	1	300	6	1 800
Driller	1	50	6	300
Driller assistant	5	30	6	900
Builder	1	40	6	240
Builder assistant	4	30	6	720
Geophysics technician	3	30	6	540
Driver	3	200	6	3 600
Labourer	5	50	6	1 500
Others	5	50	6	1 500
<b>Total</b>	<b>23</b>			<b>11 100</b>

2. EQUIPMENT	Quantity	Total cost (US\$)
Drilling rig and equipment	1	88 050
Drilling tools and consumables	1	7 391
Equipment for 10 boreholes	1	10 865
<b>Total</b>		<b>106 306</b>

3. LOGISTICS	Quantity /month	Unit cost (US\$)	Total (US\$)
4x4 vehicle	1		30 000
Drilling truck	1		15 000
Truck maintenance & fuel (month)	6	778.5	4 671
Light vehicle maintenance & fuel (month)	6	1 100	6 600
Road transport (month)	2	3 500	7 000
International transport (t)	4.5	4 500	20 250
<b>Total</b>			<b>83 521</b>

4. ADMINISTRATIVE COSTS	Duration (month)	Unit cost (US\$)	Total (US\$)
Stationery	6	200	1 200
Communications costs	6	200	1 200
<b>Total</b>			<b>2 400</b>



**Table 8.XXXIV: Cost of equipment.**

	Quantity	Unit cost (US\$)	Total (US\$)
Complete ACF-PAT 301 RT kit	1	26 000	26 000
Atlas Copco XAHS 175 compressor	1	40 000	40 000
Rotary drilling tools	1	1 900	1 900
8"1/2 three-bladed bit (216 mm)	2		
6"1/2 three-bladed bit (165 mm)	2		
3"7/8 three-bladed bit (99 mm)	2		
F 2"3/8 PAI REG x F 2"3/8 API REG adaptor	2		
F 2"3/8 API REG x F 3"1/2 adaptor	2		
DTH hammer tools	1	6 800	6 800
Stenuick Challenger 4 hammer	1		
150-mm drilling bit	4		
105-mm drilling bit	2		
assembly spanners for 150 & 105-mm drilling bits			
Pumping-test kit	1	2 500	2 500
Resistivity meter	1	5 000	5 000
Water-level dipper 50 m	1	1 000	1 000
Water-analysis kit	1	500	500
iron (ref. 11136C)	1	150	150
manganese (ref. 14768)	1	200	200
Computer and printer for report and monitoring of drilling	1	3 000	3 000
GPS	1	1 000	1 000
<b>TOTAL</b>			<b>88 050</b>

**Table 8.XXXV: Cost of drilling consumables.**

Item	Quantity	Unit cost (US\$)	Total (US\$)
<i>Borehole</i>			
103 x 113 mm casing (10/borehole)	100	12	1 200
103 x 113 mm screen (6/borehole)	60	18	1 080
167 x 180 mm pre-casing (4/borehole)	40	27	1 080
plug	10	5	50
filter gravel (600 l/borehole)	6 000	0.05	300
diesel (500 l/borehole)	5 000	0.85	4 250
petrol (150 l/borehole)	1 500	1	1 500
<i>Washing area</i>			
cement (11 bags/washing area)	55	12	660
sand (1 m <sup>3</sup> /washing area)	5	12	60
gravel (2 m <sup>3</sup> /washing area)	10	30	300
weld-mesh (1.5 sheets/washing area)	8	20	160
stone (3 m <sup>3</sup> /washing area)	15	15	225
<b>TOTAL</b>			<b>10 865</b>

**Table 8.XXXVI: Costs of tools and minor consumables.**

Item	Quantity	Unit cost (US\$)	Total (US\$)
Water tank	1	1 500	1 500
Metal shuttering mould	1	1 000	1 000
Toolkit	1	1 200	1 200
Bolt cutter for reinforcement bars	1	480	480
Measuring tape (100 m)	4	30	120
Pickaxe	10	3	30
Shovel	10	3	30
Hoe	10	3	30
Spirit level	2	30	60
Measuring tape (5 m)	10	6	60
Bucket	10	5	50
Wheelbarrow	2	20	40
Wood saw	2	10	20
Hammer	5	5	25
Sledgehammer (5 kg)	2	8	16
Hydraulic oil (l)	50	3	150
Drilling oil (Azolla) (l)	50	5	250
Motor oil (l)	50	2.5	125
Grease (kg)	30	5	150
Polycol (kg)	50	10	500
Drilling foam (l)	100	3	300
PVC 2" dia. screwed pipe (3 m)	20	15	300
PVC 2" dia. screwed pipe (1 m)	3	15	45
PVC screwed elbow for 2" PVC pipes	2	10	20
Rubber boots	15	10	150
Gloves	20	8	160
Waterproof coats	10	30	300
TOTAL			7 391

## D COMBINED WELLS

<b>1</b>	<b>Central combined wells</b>	325	1.2	Resources required	327
1.1	Implementation	325	1.2.1	<i>Human resources</i>	327
1.1.1	<i>Drilling the borehole</i>	325	1.2.2	<i>Cost of a borehole and a well</i>	327
1.1.2	<i>Digging the well</i>	325	<b>2</b>	<b>Lateral combined well</b>	328
1.1.3	<i>Planning</i>	326	2.1	Implementation	328

A combined well is a well supplied by a borehole reaching a confined aquifer. This allows exploitation of a deep aquifer with a static level near the surface, without digging a very deep well. The well therefore acts only as a storage tank, which is refilled when not in use (see Chapter 8A). This solution can be useful when the borehole yield is low, because the well acts as a water tank from which it is possible to draw a higher flow than that of the borehole. Finally, combined wells do not require the installation of any pump when local social and economic conditions do not allow it, but they nevertheless provide good-quality water.

It is relatively simple to carry out this type of work, by digging the well either around the borehole casing ('central combined well') or beside it ('lateral combined well').

Many wells have been dug on boreholes drilled with ACF-PAT 201 and 301 rigs in Asia, in sedimentary formations presenting confined aquifers with static levels near the surface. The combined wells are then equipped with VN6 handpumps (static level above 6 m) or left uncovered (extraction with a bucket) or with a shaduf (see Chapter 7A Section 1.2.2). The technical and financial aspects of this type of programme, drawn from the programmes which ACF has been carrying out in Cambodia and Myanmar for several years, are shown below.

Since 1996, ACF has also built combined wells in the North of Mali. These are equipped with traditional water-drawing systems that allow pastoral populations to exploit deep water resources without being dependent on motorised pumps. The boreholes reach 110 m on average and the wells, built beside the boreholes, are 50 to 70 m deep.

### 1 Central combined well

#### 1.1 Implementation

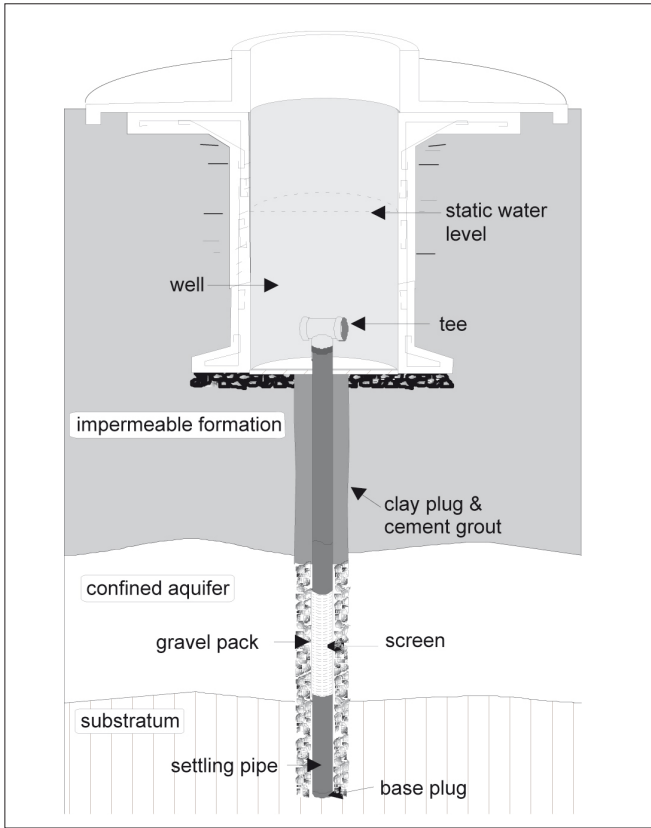
##### 1.1.1 DRILLING THE BOREHOLE

The borehole is equipped with a 2" (Myanmar) or 4" (Cambodia) casing. Gravel pack is installed around the screens, topped by a clay plug and cement grout to prevent any pollution from the surface.

The average depth of these boreholes is 15 to 30 m. They are drilled with an ACF-PAT 201 rig in non-consolidated formations, or with a 301 rig in harder formations (sandstone, compact clays).

##### 1.1.2 DIGGING THE WELL

The well is dug around the borehole, with a 1.2 m diameter, down to a minimum depth of 2.5 m below the static water level measured in the borehole (the lowest during the low-water period). For a given well diameter, the depth is chosen on the basis of technical criteria (obtained by pumping tests – see Chapter 6) and human criteria (daily needs, water-drawing rate).



**Figure 8.27: Central combined well (ACF, Cambodia, 1998).**

In Myanmar, well rings with an internal diameter of 1 m (height 0.5 m) are pre-cast on site one week before use. A bottom slab for the well is cast in reinforced concrete (thickness 10 cm) on a hard-core foundation, to support the well-ring column which is then built up to the surface. To ensure impermeability in cases where a large quantity of water comes in to the well along the borehole casing, quick-setting cement is used to grout around the borehole casing (see Figure 8.27).

In Cambodia, the well is built using the bottom-up *in-situ* lining technique (see Chapter 7A). The borehole casing is then cut 0.5 m above the bottom slab. To avoid leaving the casing opening facing upwards and to limit any intrusion into the borehole, a tee is fitted at the top of it. Surface works (headwall, apron and drain) are then built.

### 1.1.3 PLANNING

An example of building time is given in Table 8.XXXVII.

**Table 8.XXXVII: Time required for construction of a central combined well.**

	Week 1	Week 2	Week 3
Drilling and development	.....		
Pre-casting of well rings	.....		
Digging of the well		.....	
Bottom slab and lining			.....
Surface works			.....

## 1.2 Resources required

### 1.2.1 HUMAN RESOURCES

The human resources required are the same as those required for digging a well and drilling a borehole, Table 8.XXXVIII. (see also Chapters 7B and 8C).

**Table 8.XXXVIII: Human resources (ACF, Myanmar, 1997).**

Indicative monthly salary (US\$)	
<i>Borehole team</i>	
1 geologist	200-250
1 driller	150-250
1 driller assistant	100-150
1 mechanic	100-150
3 labourers	40-80
1 driver	60-80
<i>Well team</i>	
1 site manager	150-200
1 assistant	100-150
5 labourers	40-80
1 driver	60-80

### 1.2.2 COST OF A BOREHOLE AND A WELL

An example of the cost of materials necessary for the construction of a combined well is shown in Table 8.XXXIX.

**Table 8.XXXIX: Cost of materials for a combined well (ACF, Cambodia, 1997).**

Description	Units	Quantity	Unit cost (US\$)	Total cost (US\$)
<i>25 m borehole</i>				
PVC 2" casing (63 mm ext.)	pcs 3 m	7	8	56
2" screen	pcs 3 m	1	9	9
2" plug	pcs	1	1	1
Tee	pcs	1	2	2
2" sockets	pcs	10	1	10
Gravel filter	m <sup>3</sup>	0.3	20	6
Cement	50-kg bags	3	7	21
Quick-setting cement	kg	3	1.5	4.5
Diesel	l	90	0.5	45
Petrol	l	10	0.4	4
Total cost per borehole				158.5
<i>Well with a 1 m internal diameter, 6 m deep</i>				
Cement	50-kg bags	62	7	434
Sand	m <sup>3</sup>	4	5.5	22
Gravel	m <sup>3</sup>	6	5.5	33
Stone	m <sup>3</sup>	3	7	21
Bricks (apron, drain)	pcs	200	0.04	8
8-mm reinforcement bar	m	200	0.4	80
6-mm reinforcement bar	m	400	0.3	120
Iron wire	kg	7	2	14
Total cost per well				732
GENERAL TOTAL				990.5

## 2 Lateral combined well

Another design involves digging the well beside the borehole (see Figure 8.28). This can be a little bit more complicated to build, but has the following advantages:

- it provides two distinct water sources; one potable water source for human consumption (water pumped from the borehole) and another one for livestock (water drawn by traditional methods from the well);
- in the case of deep wells and a risk of sand intrusion (due to traditional water-drawing, wind-blown sand etc.), it is possible to use a derrick to clean out the well with a bailer, which is impossible in the case of a well around a borehole without damaging the connection between the two;
- the borehole remains accessible for maintenance and development.

In the Sahel, the well is usually connected to the borehole with lateral connections, but this connection can only be made if the ground is stable enough for horizontal digging (up to 2 m).

### 2.1 Implementation

In order to facilitate the connection, the well must be dug approximately 1 m from the borehole. Knowing the vertical deviation of the borehole will help to define exactly where to dig. This information can be obtained from the drilling files.

The pumping test will determine the yield and dynamic levels, that will allow the establishment of the depth of the connection (see Chapter 6). The study of the geological log obtained during drilling will confirm the feasibility of constructing the connection at that depth (stable ground, not sandy). In the case of instability, the connection should be done deeper (if economically acceptable) or the well should be dug around the borehole, see Section 1.

When the depth of the connection is decided, the well can be dug using the normal method, up to 1.50 m below the level of the connection, in order to enable settlement of any solids in the water to below the level of the connection, to protect it from obstruction by sediment.

The connection to the borehole is the crucial part of the construction. This connection must be made with great care, in order to ensure the longevity of the combined well. The levelling is carried out in the well, vertically using a plumb-line, and horizontally, taking distance estimation and geological factors into account.

A tunnel 1 m long and 0.6 m high must then be dug horizontally, in order to clear a space around the casing to be able to make the connection. Once the casing has been reached, there are several possible solutions, the objective being to make the connection between the borehole and the well completely water-tight, to protect it from outside elements that could contaminate it, or cause blockage.

In Mali the connection is made with pre-fabricated reinforced concrete box sections 0.60 x 0.40 x 0.20 m (L x H x D), 5 cm thick. This solution has the advantage of using ready-made elements, given that it can be difficult to pour concrete in a tunnel where water runs in. The pre-cast box sections are laid going backwards from the borehole, with the first one closed behind the borehole to guarantee water-tightness. The box sections are attached to each other with 'pins' and then a fine layer of concrete is applied on the lower part and on the inside for solidity and water-tightness. The tunnel is also coated with a fine layer of mortar going backwards. The last box section has protruding reinforcement bars that allow it to be tied to the reinforcement bars of the well lining. The main concern is always the water-tightness of the structure. It is also possible to pour the concrete with wooden shuttering. The use of an accelerator such as Sicalatex can increase the quality of the concrete.

Another solution is to connect the borehole casing to another pipe that carries the water directly to the well without a tunnel.

When the connection is finished, it is preferable to wait several days before allowing water to flow, in order to let the concrete set. There are two options for opening the connection; either perforating the casing directly (with a special tool), or installing a saddle clamp (or ferrule strap) with a valve.

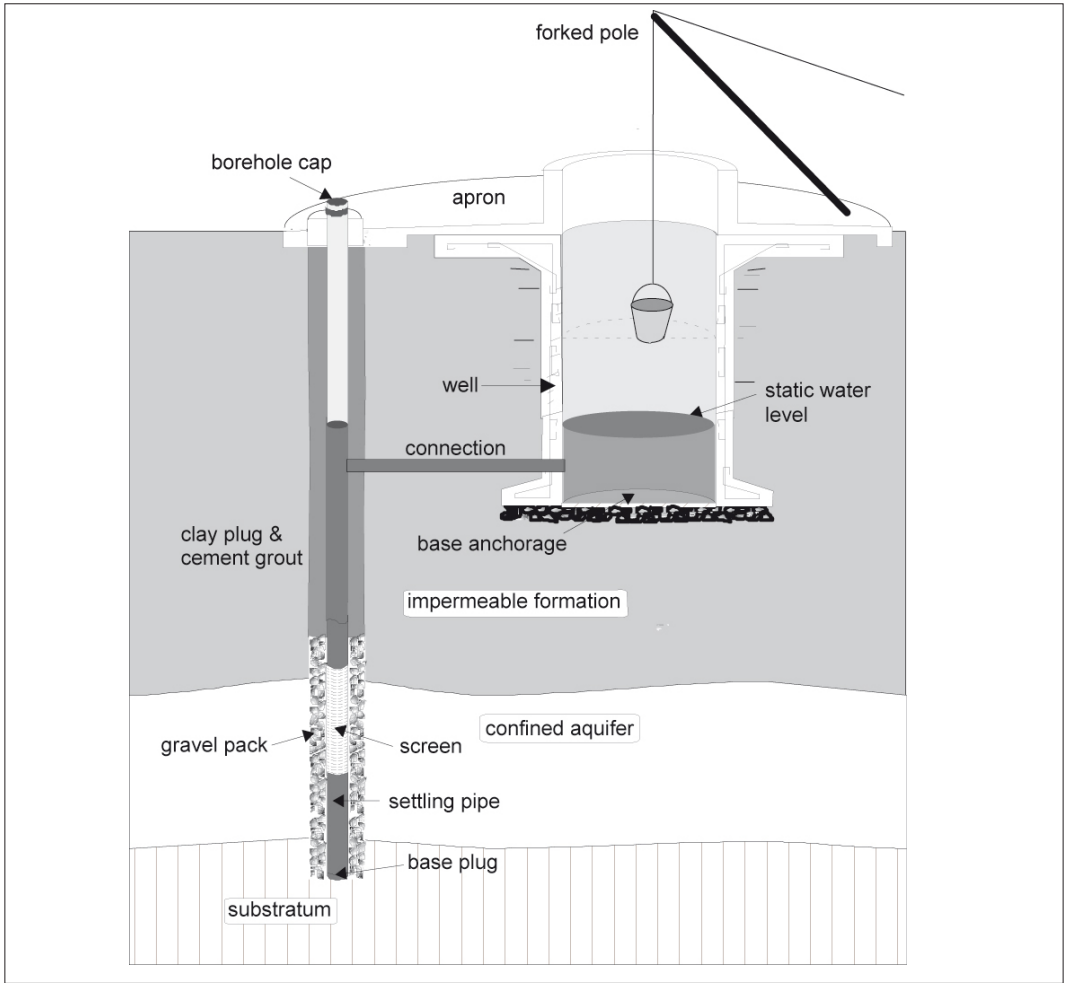


Figure 8.28: Lateral combined well (ACF, Mali, 2003).





# Pumping systems

---

<b>1</b>	<b>General</b>	331			
<b>2</b>	<b>Motorised pumps</b>	332			
2.1	Working principles				
	of centrifugal pumps	332			
2.2	Centrifugal pump sealing	333			
<b>3</b>	<b>Pumping hydraulics</b>	334			
3.1	Power	334			
3.2	Suction head	334			
3.3	Flow and Total Manometric Head (TMH)	335			
3.3.1	<i>Characteristic curve of a pump</i>	335			
3.3.2	<i>Head losses</i>	335			
3.4	Working point in a pipe system	337			
3.5	Particular characteristic curves	337			
3.5.1	<i>Effect of rotor speed</i>	337			
3.5.2	<i>Throttling delivery pipes</i>	338			
3.5.3	<i>Mounting two identical pumps in series</i>	338			
3.5.4	<i>Mounting two identical pumps in parallel</i>	339			
3.5.5	<i>Mounting two different pumps</i>	340			
<b>4</b>	<b>Choosing a motorised pump</b>	340			
4.1	Surface centrifugal motorised pump	340			
4.2	Submersible electrical pump	342			
<b>5</b>	<b>Electricity supply</b>	343			
5.1	Power and current	344			
5.1.1	<i>Performance</i>	344			
5.1.2	<i>Electrical power</i>	344			
5.1.3	<i>Current and voltage</i>	344			
	5.1.3.1 Nominal current absorbed by the motor	344			
	5.1.3.2 Starting current and power required	344			
	5.1.3.3 Voltage drop	345			
	5.2 Generator choice	345			
	5.2.1 <i>Theoretical power calculation (motor and generator)</i>	346			
	5.2.2 <i>Empirical calculation</i>	346			
<b>6</b>	<b>Dewatering pumps</b>	346			
6.1	Principle and material	346			
6.2	Electric dewatering pumps	346			
6.3	Pneumatic water pumps	347			
<b>7</b>	<b>Renewable energy pumps</b>	347			
7.1	Solar pumping	348			
7.1.1	<i>Solar energy</i>	348			
7.1.2	<i>Solar pumping station design</i>	349			
	7.1.2.1 Principle	349			
	7.1.2.2 Example of a pumping station	350			
7.2	Hydraulic energy	350			
7.2.1	<i>Rotary speed of the pump</i>	352			
7.2.2	<i>Performance test</i>	352			
7.2.3	<i>Components of a Garman pump</i>	353			
<b>8</b>	<b>Handpumps</b>	353			
8.1	Main types of handpump	353			
8.2	Piston pumps	354			
8.2.1	<i>Submerged pumps</i>	354			
8.2.2	<i>Suction pumps</i>	356			
8.3	Hydraulic pumps	356			
8.4	Helical rotary pump	358			
8.5	Rope-and-washer pump	359			
8.6	Treadle pump	360			

---

The choice of a pumping system must be made bearing in mind not only the technical constraints (pump type, energy, head, flow, turbidity), but also the constraints of the socio-economic context (appropriate pumping system, availability of spares, ease of maintenance). This chapter presents the theoretical background for the choice and installation of pumps for medium and long-term interventions, illustrated by practical examples.

## 1 General

Table 9.I shows the pump types most widely used. All pumps are made up of three different parts:

- the motor, which provides the power necessary for pumping;
- the transmission, which conveys the power to the hydraulic component;

**Table 9.I: Types of pump.**

Type of pump	Normal application	Technology
Manual	Wells and boreholes	Surface suction pump → piston Medium and high-lift pump with the hydraulic component submerged (also exist as motorised models) → piston → hydraulic balloon → screw (also exist as motorised models)
Submersible electric	Wells and boreholes for flows > 2m <sup>3</sup> /h Pumping tests	Lift pump → multi-stage centrifugal
Dewatering pump	Pumping out excavations (digging wells below water table) Pumping surface water	Lift or suction-lift → centrifugal → pneumatic membrane
Surface motorised pump	Pumping surface water Pumping from reservoir to network or other reservoir	Suction-lift (suction head limited to 7 m) → centrifugal

– the hydraulic component, which transmits the power to the water in order to move it (to pump it in or out).

Table 9. II shows the working principle of the different types of pump.

**Table 9.II: Working principles of commonly-used pumps.**

	Drive	Transmission	Hydraulic component
Manual	Hand Foot	Mechanical (rod and lever) Hydraulic (water pipe)	Volumetric pump (with submerged or non-submerged piston, or balloon)
Motorised pump (surface)	Internal combustion engine (diesel, petrol) Direct drive or via generator & motor	Shaft and bearings	Centrifugal pump
Electric pump (submersible)	Electric motor	Shaft	Multi-stage centrifugal pump
Dewatering pump (pneumatic)	Compressor	Compressed-air line	Volumetric pump (membrane)

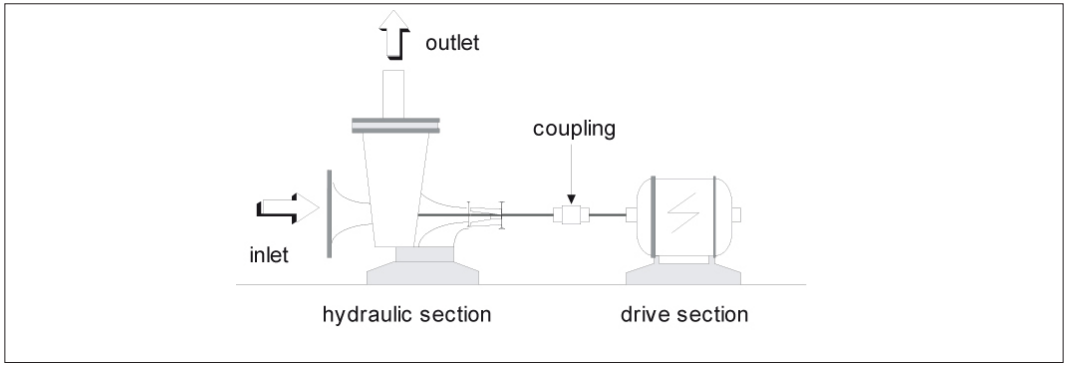
## 2 Motorised pumps

There are two main types of motorised pump: centrifugal and volumetric. The latter are suitable for lifting small water flows at high pressure (e.g. high-pressure washers).

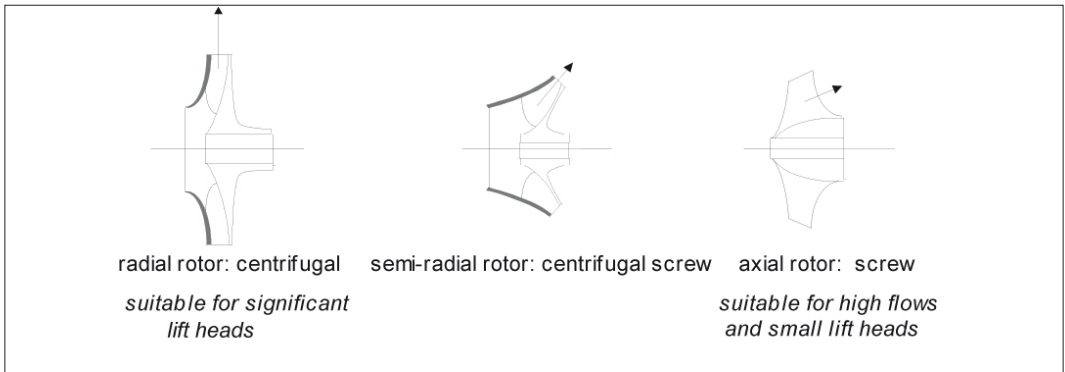
For drinking water, the only volumetric pumps commonly in use are handpumps (see Section 8).

### 2.1 Working principles of centrifugal pumps

Centrifugal pumps belong to the turbo-pump family (Figure 9.1). In a turbo-pump, a rotor, fitted with blades or paddles driven by rotary movement, transmits kinetic energy to the fluid, some of which is transformed into pressure by reduction of velocity in a component known as the stator. Different types of turbo-pumps have different shaped rotors (Figures 9.2 and 9.3).



**Figure 9.1: Electric centrifugal pump (surface).**



**Figure 9.2: Rotor designs in turbopumps.**



**Figure 9.3: Rotor designs in centrifugal pumps.**

The driving force to the shaft can be supplied by an internal combustion engine, an electric motor (either submersible or surface-mounted), or by any other force, such as a turbine in a river.

## 2.2 Centrifugal pump sealing

The drive shaft passes into the pump casing in which the rotor turns, through a sealing system consisting of packing (graphite), wrapped around the shaft and retained by a gland.

The packing seal is not perfect: it always leaks a little and so lubricates and cools the shaft. Therefore the gland should not be tightened too much, because that would wear out the packing quickly. Once the packing is worn out, it can be added to without removing the old one.

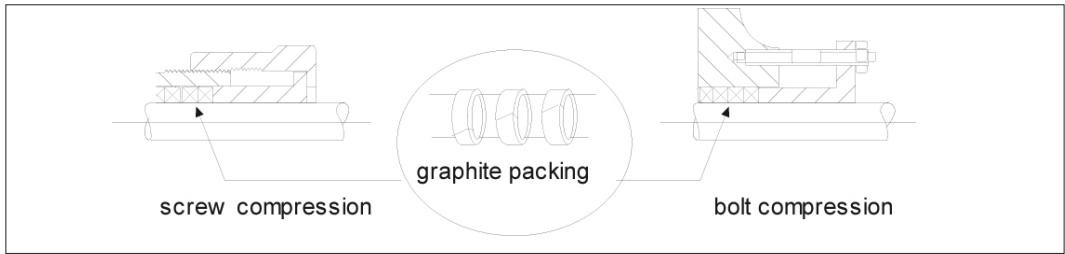


Figure 9.4: Packing.

## 3 Pumping hydraulics

### 3.1 Power

In order to transfer a certain quantity of water from one point to another, the pump must transmit energy to it. This quantity of energy is the same whatever the pumping technology, and is generated by the pump drive. This energy is calculated using Bernoulli's theorem (see Annex 12A), taking into account all the parameters of the energy balance of the system, such as pump altitude, head, length and diameter of the pipes. However, in order to simplify calculations in practice, two parameters that characterise any pumping system are used: the flow ( $Q$ ) and the Total Manometric Head (TMH), (see Section 3.3 for definition of TMH). The power absorbed at the pump shaft is therefore given by the following equation (the specific gravity of water is 1):

$$P_{ef} = \frac{Q \times TMH}{367 \times \eta}$$

where  $P_{ef}$  is the effective power (kW, 1 kW = 1.36 HP), TMH the total manometric head (mWG (metres water gauge)),  $Q$  the flow ( $m^3/h$ ) and  $\eta$  the pump efficiency. The optimum efficiency (between 0.8 and 0.9) lies in the working range of the pump (efficiency curve provided by the manufacturer).

The motive power necessary to drive the hydraulic section is always higher than the power absorbed by the shaft, bearing in mind various losses due to transmission, calculation uncertainties, head-losses at the pump level, and starting torque.

### 3.2 Suction head

The suction head is theoretically limited to 10.33 m, which corresponds to the suction pressure necessary to create a vacuum (expressed in water column height at normal atmospheric pressure) inside a pipe and to lift water.

In practice, however, suction head is less than that, because some of the pressure is required to transfer the required velocity to the water, and some is absorbed by head-losses in the suction pipe.

Furthermore, the suction pressure inside the pipe must not be less than the value at which the water vapour pressure is reached (water evaporation). For drinking-water pumps (temperature less than 20°C), the water vapour pressure is around 0.20 m head: beyond that point there is a risk of entraining water vapour. The water vapour bubbles thus formed in the suction pipe are re-compressed in the hydraulic section, which causes excessive rotor wear. This phenomenon, known as cavitation, reduces pump efficiency, and makes a characteristic noise caused by the implosion of the water vapour bubbles. Theoretically, at the pressure necessary to move water (at 20°C):

$$\text{Suction head} = 10.33 - 0.2 \text{ J (head-losses)}$$

Generally, the suction potential of a surface pump, depending on its characteristics and installation conditions, are determined by the NPSH (net positive suction head). This parameter is given by the

**Table 9.III: Suction head depending on the pump type.**

Types of surface pump	Maximum suction head	Examples of pumps
Surface-mounted manual piston pumps	7 – 10 m depending on model	Type VN6
Small electric centrifugal pumps	8 m maximum	All makes, all origins
Large electric centrifugal pumps	See NPSH	All makes Grundfos, KSB, Voguel
Surface-mounted centrifugal motor-driven pumps (petrol)	Up to 10 m with careful use	Robin, Tsurumi, Honda engines
Large surface-mounted centrifugal pumps (diesel)	See NPSH Max 7 m	Pumps with Lister engines

manufacturer depending on the pump output and installation conditions. The static suction head (Table 9.III) plus the head-losses must always be lower than the NPSH required for the pump.

In order to raise water beyond that height, it is necessary to use a submersible lift pump, rather than a suction pump.

All things being equal, the suction head also affects the total pressure head of the pump.

Suction pumps with a hydrojector are a particular kind of surface suction pump that can lift water beyond the theoretical suction head. One part of the water supplied by the pump is in fact pumped back into the hydrojector (2<sup>nd</sup> tube in the borehole) in order to be able to attain heights of water greater than 10 m; the pump efficiency is however somewhat reduced.

### 3.3 Flow and Total Manometric Head (TMH)

These two parameters are related directly to the usable flow and the height to which the pump can lift. This height, plus head-losses and the residual pressure at the end of the pipe, is expressed as follows:

$$\text{TMH} = (h_s + h_d) + J + P_r$$

where TMH is the total manometric head (mWG),  $h_s + h_d$  is the suction head + the delivery head (m), J (m) is the head-loss due to piping and accessories (valves, bends) and  $P_r$  the residual pressure (mWG), i.e. the pressure at the outlet from the delivery pipe.

#### 3.3.1 CHARACTERISTIC CURVE OF A PUMP

For a given pump, the higher the TMH, the less the flow provided by the pump. The various pairs of points (TMH-flow) form the characteristic curve of the pump. Outside this curve, the pump is not within its optimum configuration, which causes a drop in efficiency (Figure 9.5).

#### 3.3.2 HEAD-LOSSES

The equation used to calculate head-losses (friction of the liquid against the walls, and change of section or direction) is the Colebrook-White formula (see Annex 12A).

In the majority of cases, the head-losses J are functions of linear head-losses (total pipe length  $L_s + L_d$ ) and secondary head-losses (strainers, bends, valves). The latter can be estimated at 10% of the linear head-losses, except for surface pumps, where the secondary head-losses are calculated precisely in order to determine the maximum suction head (limited by the NPSH).

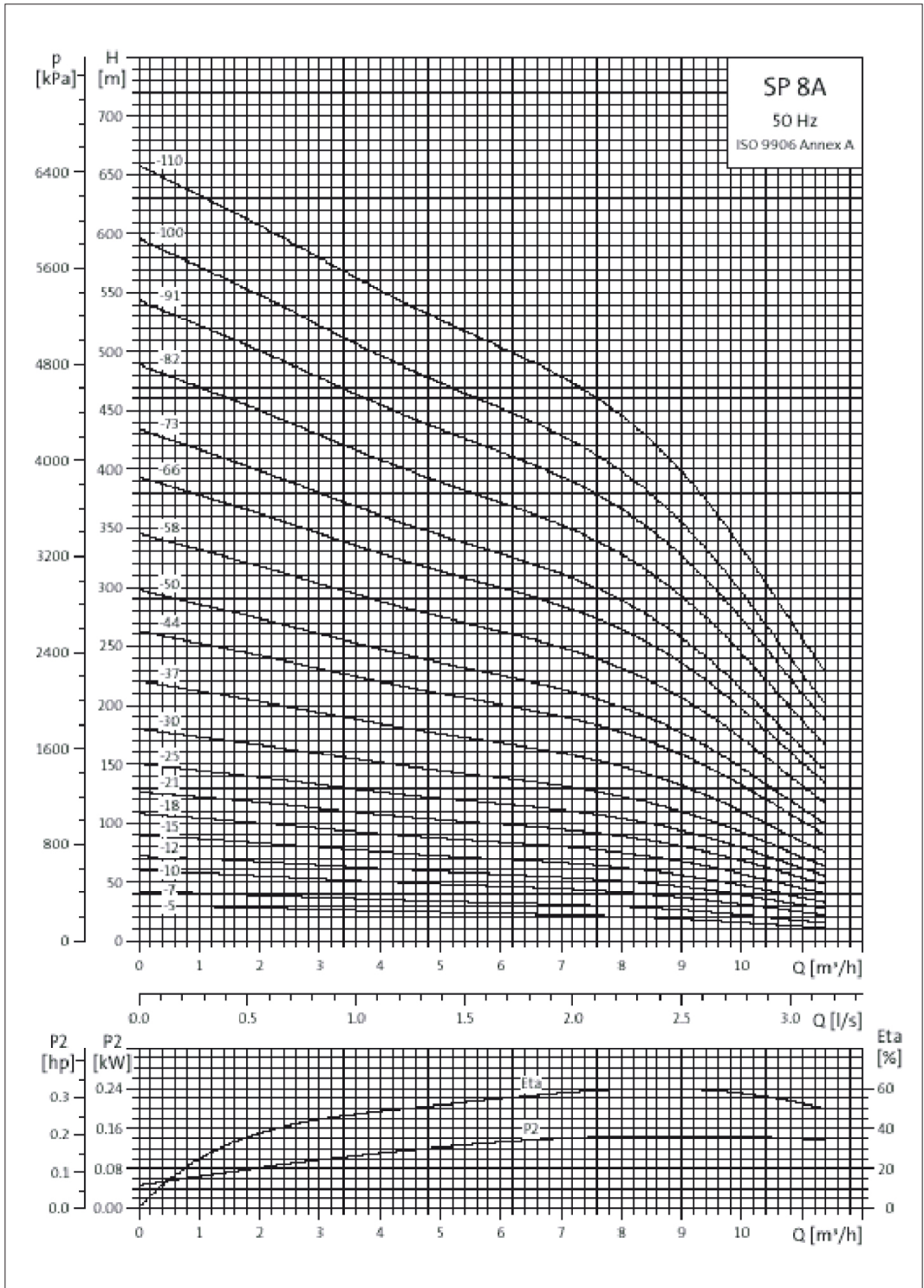


Figure 9.5: Characteristic curve for the Grundfos SP8A range of pumps, and efficiency curves where Q = flow, H = TMH, and  $\eta$  = efficiency.

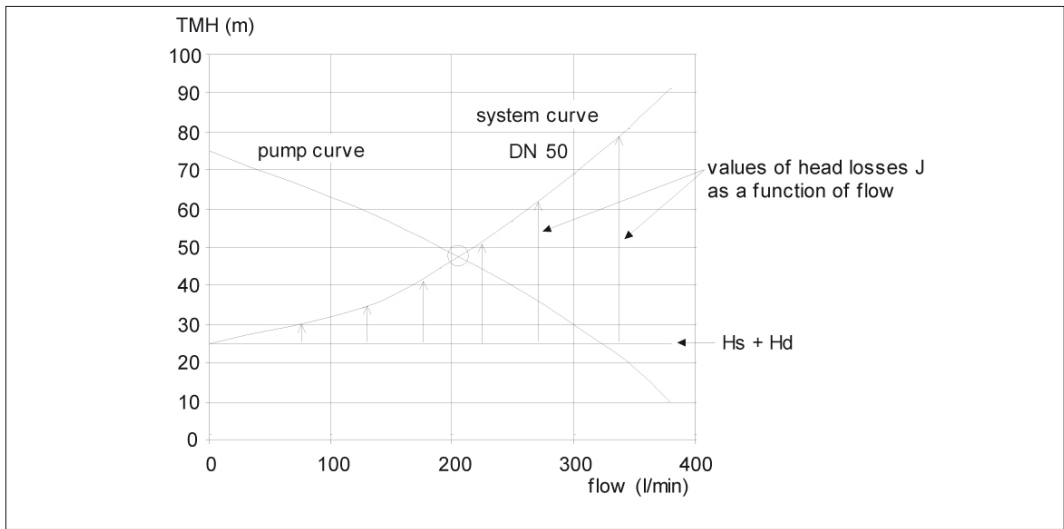
### 3.4 Working point in a pipe system

This point is the TMH-flow pair corresponding to the pump function, taking into account the head-losses in the pipe system. When the pump operates, a particular working point is reached, corresponding to the balance between flow and TMH.

To calculate this working point in advance, a graph representing the characteristic curve of the pipe system is drawn. This graph is obtained by calculating the head-losses for different theoretical flows in the system (Table 9.IV). The intersection point of this curve with the characteristic curve of the pump gives the working point of the pump in the pipe system (Figure 9.6).

**Table 9.IV: Head losses as a function of flow Q.**

Q (l/min)	Static head (m) (H = H <sub>s</sub> + h <sub>d</sub> )	Head losses J (mWG)	TMH (m) (TMH = H + J)
0	25	0	25
125	25	9	34
250	25	32	57
300	25	44	69
380	25	66	91



**Figure 9.6: Working point (TEF2-50 pump in pipe system).**

### 3.5 Particular characteristic curves

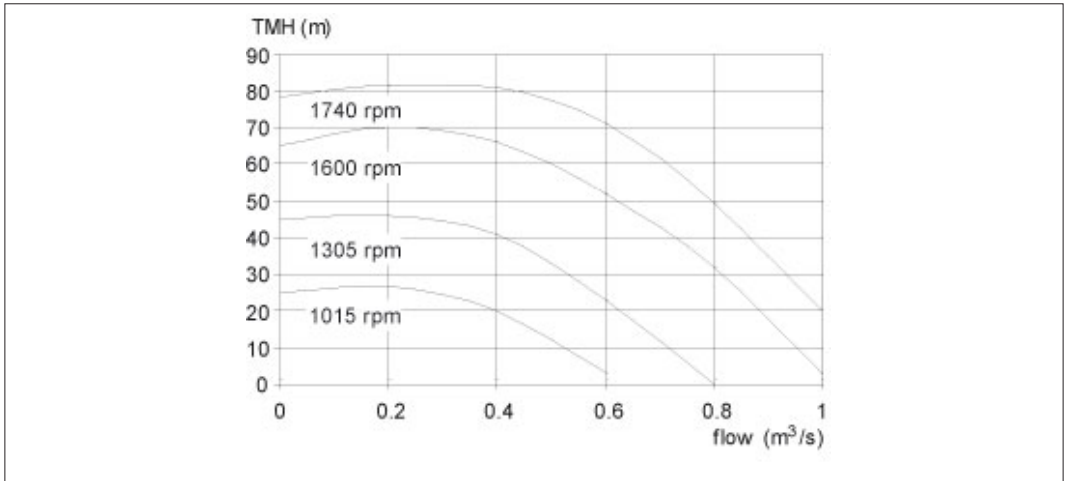
#### 3.5.1 EFFECT OF ROTOR SPEED

The rotational speed of the shaft is usually measured in revolutions per minute (rpm).

If the rotational speed of a given pump rises from  $n_1$  to  $n_2$  rpm, the flow  $Q$ , the TMH, and the absorbed power  $P$ , change as in the following equations:

$$Q_2 = (n_2/n_1)Q_1 \quad H_2 = (n_2/n_1)^2 H_1 \quad P_2 = (n_2/n_1)^3 P_1$$

With an internal-combustion engine or a dc electric motor, this speed can be changed in order to adapt to a given situation. Certain manufacturers provide characteristic pump curves corresponding to



**Figure 9.7: Characteristic curves for a centrifugal pump as a function of rotational speed.**

specific rotational speeds (Figure 9.7). Usually, electric pumps have rotational speeds of 3 000 rpm for bipolar asynchronous motors (rotational speed = frequency / number of pairs of poles of the motor). This is the case for all submersible pumps without a speed regulator.

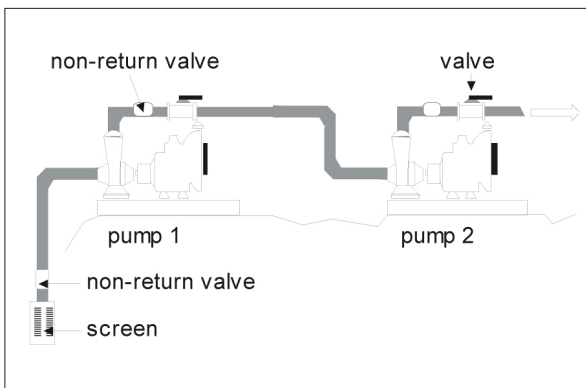
### 3.5.2 THROTTLING DELIVERY PIPES

By throttling delivery pipes with valves, it is possible to reduce the pump flow by increasing head-losses. This results in an immediate reduction in efficiency of the pump, and an increase in power requirement. Therefore, at larger pumping stations, using valves to reduce flow increases energy consumption considerably.

Also, too great a restriction risks operating outside the design range of the pump, thereby increasing mechanical stresses.

### 3.5.3 MOUNTING TWO IDENTICAL PUMPS IN SERIES

Mounting two pumps in series (Figure 9.8) increases the delivery head. If the initial flow of a single pump is maintained, the TMH is doubled. In practice, the TMHs may be added to create the characteristic curve required.



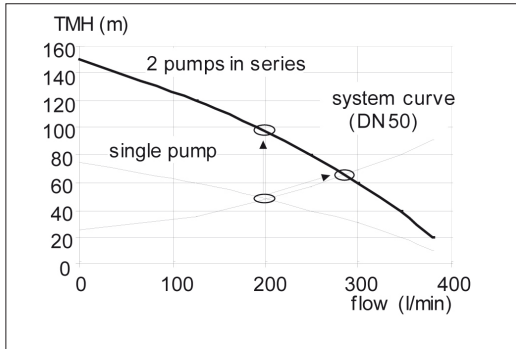
**Figure 9.8: Mounting two identical pumps in series.**



**Table 9.V: TMH and flow for two pumps in series.**

Function	Flow (l/min)	TMH (mWG)
Single pump in pipe system	200	50
Pumps in series in pipe system	290	65
Pumps in series with valve-controlled flow	200	100

For example, if two identical pumps, each capable of lifting 200 l/min to 50 m (e.g. Tsurumi TEF2-50 motorised pump, Robin engine) are mounted in series, they can lift a flow equivalent to 200 l/min with a TMH of 100 m. If the flow is not choked, the working point is established within the working curve in the network (Table 9.V and Figure 9.9).



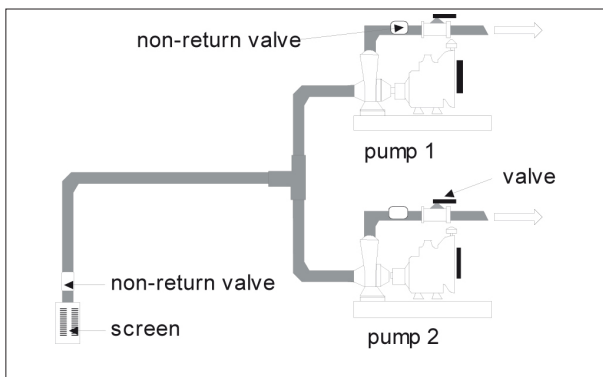
**Figure 9.9: Characteristic curves for a single pump and for two pumps in series.**

### 3.5.4 MOUNTING TWO IDENTICAL PUMPS IN PARALLEL

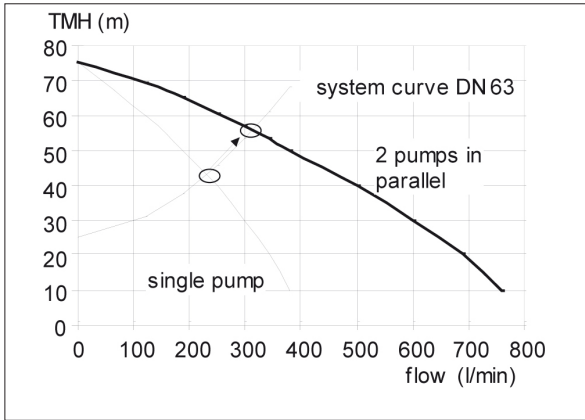
Mounting two pumps in parallel (Figure 9.10) allows the pumped flow in a pipe system to be increased. In practice, the flow of both pumps may be added, while maintaining the TMH, to draw the characteristic curve (Table 9.VI and Figure 9.11). But in a pipe system, head-losses  $J$  increase with flow, so it is not possible to double the flow.

**Table 9.VI: Characteristic curves for two identical pumps in parallel.**

Function	Flow (l/min)	TMH (mWG)
Single pump in pipe system	240	43
Pumps in parallel in pipe system	320	57



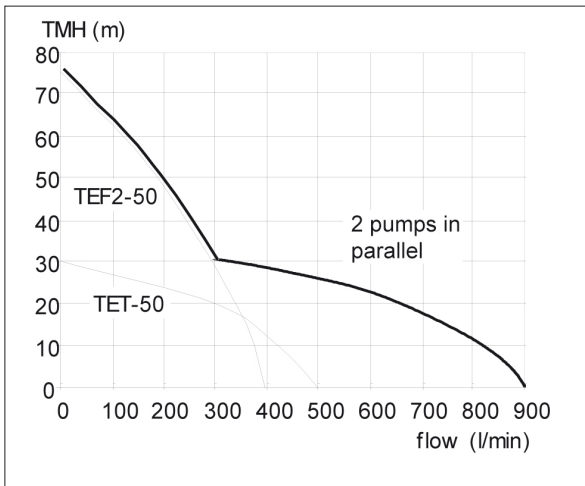
**Figure 9.10: Mounting two pumps in parallel.**



**Figure 9.11: Characteristic curves for two pumps mounted in parallel.**

### 3.5.5 MOUNTING TWO DIFFERENT PUMPS

It is possible to mount different pumps in series or in parallel. The principle is the same: in series the TMHs are added, while in parallel the flows are added. The working point can be determined by drawing the characteristic curve of the two pumps and the pipe system. In the example given in Figure 9.12, there is no point in connecting these two pumps for a TMH higher than 30 m; the flow will not increase. For a TMH of 20 m, the pump flow will be 600 l/min, instead of 350 l/min with the TEF2-50 pump used alone.

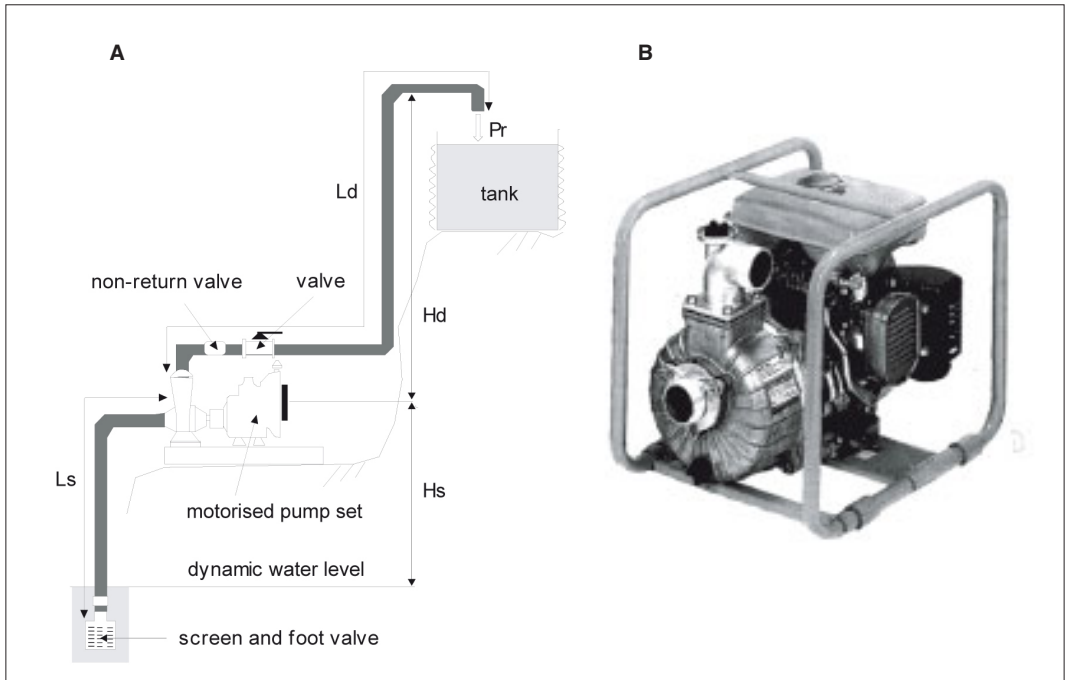


**Figure 9.12: Characteristic curves for two different pumps in parallel (types TET-50 and TEF2-50).**

## 4 Choosing a motorised pump

### 4.1 Surface centrifugal motorised pump

In the example given in Figure 9.13A, the motorised pump takes water from a depth of 5 m ( $H_s$ ) and delivers it at a height of 25 m ( $H_d$ ). The pipe used has an inside diameter of 40.8 mm (DN 50); the total length of the delivery pipe is 200 m ( $L_d$ ), and the total length of the suction pipe is 6 m ( $L_s$ ). The flow required is 2 l/s, i.e. 120 l/min, with a residual pressure of 1 bar, i.e. 10 m water head. The total manometric generated head is:



**Figure 9.13: Surface-mounted motorised pump.**  
**A: installation diagram. B: photograph.**

$$\text{TMH} = H_s + H_d + J \text{ linear} + Pr + J \text{ secondary}$$

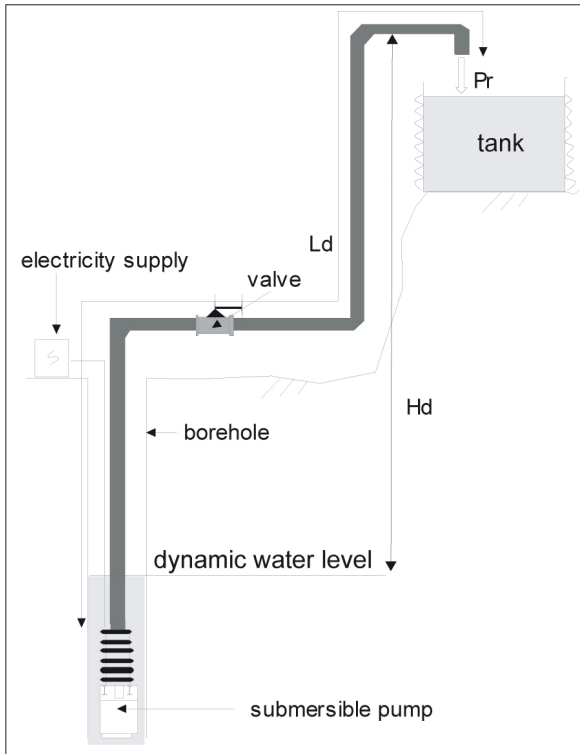
$$\text{TMH} = (5 + 25) + (206 \cdot 5,85\%) + 10,33 + 10\% \text{ of } J \text{ linear} = 53 \text{ m}$$

A pressure of 1 bar is equal to 10.33 mWG under normal temperature and pressure conditions; 5.85% represents the head-loss coefficient per m of pipe for the given conditions (DN 50 pipe, flow 2 l/s – see Chapter 11 and Annex 12A). Calculating the TMH allows the TMH-flow pair (53 m, 120 l/min) to be determined in order to choose a suitable pump.

Here, the corresponding pump is the TEF2-50 (Figure 9.12). The manufacturers give the characteristics of the pumps in the form of families of curves (see Figure 9.15). Normally, a technical file (Table 9.VII) is created to avoid errors in dealing with the order (choice of pipes, markings, type of fuel etc.).

**Table 9.VII: Technical file for a pump.**

DN suction (mm)	50
DN delivery (mm)	1 x 40 + 2 x 25
Maximum flow (l/min)	400
Maximum TMH (m)	75
Working point	
Flow (l/min)	120
TMH (m)	53
Application	Pumping from a stream
Engine	ROBIN EY-20D
Power (hp, rpm)	5.0/4 000
Type / fuel	4 stroke, air-cooled, petrol



**Figure 9.14: Installation plan for a submerged multistage electric pump.**

## 4.2 Submersible electrical pump

To calculate the TMH of an submersible electrical pump (shown in Figure 9.14), the same procedure as that given in paragraph 4.1 is followed:

$$\text{TMH} = (60 + 25) + (260 \cdot 5.85\%) + 10.33 + \text{Secondary} \approx 120 \text{ mWG}$$

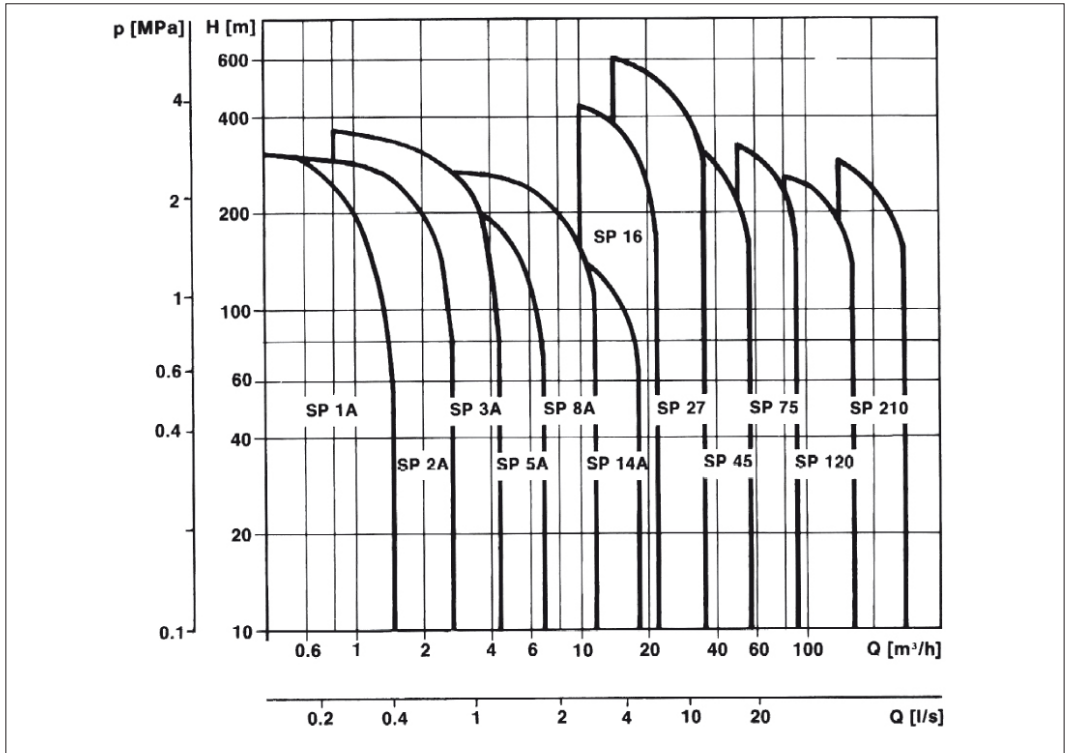
Strictly speaking, secondary head-losses should be calculated. In the case of a submersible lift pump (no suction head), this term is sometimes neglected or arbitrarily taken as 10%.

The coding of Grundfos pumps is presented in the form SP 5 A 12, for example, where SP stands for submersible pump, 5 the exploitation flow range (5 m<sup>3</sup>/h) and 12 the number of stages (multi-stage pump).

For the example given, a pump capable of producing 7.2 m<sup>3</sup>/h at 120 mWG is required. It is therefore necessary to choose the SP 8A series (Figure 9.15) and, from that series, the 30-stage pump (Figure 9.5) is the SP 8A 30. Table 9.VIII indicates the external diameters of the pumps for 4" and 6" boreholes.

**Table 9.VIII: Diameters of Grundfos submersible pumps.**

Pump range	Diameter (mm)	Diameter (mm)	Diameter (mm)
SP1A - 5A	95		
SP8A - 5 to 25		101	
SP8A - 30/50			138
SP 14A		101	
SP 45 A			145 to 192



**Figure 9.15: Range of Grundfos pumps.**

The pump can work from electric mains or a generator, with connections consisting of:

- a waterproof cable to connect the pump to the control board;
- a control board linking up with the generator or mains.

## 5 Electricity supply

Depending on the situation in the field, the electrical supply may come from:

- the mains (mainly in an urban environment);
- a generator (where there is no suitable mains supply);
- a solar energy system.

Each system has its own constraints (technical level required, equipment and running costs, payback period, equipment maintenance), which must be evaluated (Table 9.IX). All things being

**Table 9.IX: Various electricity supplies for pumps.**

Supply	Aspects to be evaluated or verified
Mains	Reliability of the mains: phases, power cuts, voltage drops Installation of a transformer; supply cable (length and diameter), power losses
Generator	Generator capacity; supply cable (length and diameter); phases
Solar	Power needed; number of photovoltaic panels Inverter – supply cable (length and diameter)

equal, a solar installation is better in terms of running costs, but will be much more expensive than installing a standard generator.

## 5.1 Power and current

Whatever the type of electricity supply, it is fundamental to estimate the power consumed by the electric motor of the pump. Section 3.1 explains in detail how to calculate the power depending on the TMH and flow. The power consumed by the pump motor can now be determined.

### 5.1.1 PERFORMANCE

Depending on the type of transmission between the pump and motor, the efficiency, or ratio between the effective hydraulic power and the mechanical power provided by the motor is:

- 85% to 90% in the case of a direct shaft drive;
- 70% in the case of a belt drive.

$$P_{\text{motor}} = \frac{P_{\text{ef}}}{0.7}$$

### 5.1.2 ELECTRICAL POWER

Nominal power:  $P = VI$  (kVA), is the power used to designate generators.

Actual power:  $P = VI \cos \phi$  (kW), is the power used to calculate the consumption of motors. It takes into account the reactive power factor  $\cos \phi$ , equal to 0.8.

### 5.1.3 CURRENT AND VOLTAGE

On the motor specification plates, two values of current are given:

- nominal current  $I_n$ , drawn during normal running;
- starting current  $I_s$ , drawn when the motor starts, greater than  $I_n$ .

#### 5.1.3.1 Nominal current absorbed by the motor

- for dc:  $I_n = (P_n \times 1,000)/(V\rho)$
- for single-phase ac:  $I_n = (P_n \times 1,000)/(V\rho \cos \phi)$
- for three-phase ac:  $I_n = (P_n \times 1,000)/(\sqrt{3}V\rho \cos \phi)$

where  $I_n$  is the nominal current (A),  $P_n$  the nominal power of the pump motor (kW),  $V$  the voltage (V) and  $\rho$  the motor efficiency.

The more powerful the motor, the higher its efficiency. For 50 kW motors, the efficiency is 0.85; for 1 kW motors it is lower, about 0.70. The higher the hydraulic head-losses, the lower the efficiency. A full-load current  $C$  can then be defined for minimum head-losses and optimum performance. Choking (increase of head-losses) causes a decrease in motor efficiency, and therefore a higher power consumption than the normal regime (see Section 3.5.2).

Motors of 1 to 10 kW AC running at 3 000 rpm draw the following currents:

- single-phase 220 V: 5.0 A per kW;
- three-phase 220 V: 3.8 A per kW;
- three-phase 380 V: 2.2 A per kW.

#### 5.1.3.2 Starting current and power required

When the motor starts, the power absorbed (for running up the electric motor and hydraulic gear from 0 to 3 000 rpm) is very much higher than the nominal power. As the voltage is fixed, the

current increases. Manufacturers generally give the ratio  $I_s/I_n$ , which gives the voltage absorbed when the pump is started directly. The actual value (around 6) is noted on the pump motor plate.

The power of the generator or the mains to which the pump is connected must be sufficient for the starting current  $I_s$ . This therefore is the term used for calculating the generator power necessary to drive the pump, using the following formula:

$$P \text{ (kVA)} = VI_s$$

Since this current is absorbed in a very short time, an empirical calculation for generator design is suggested (see Section 5.2.2).

### 5.1.3.3 Voltage drop

The motor works optimally at a certain voltage. The size of the supply cables must be calculated so as not to cause a voltage drop of more than 5% at the motor terminals (Table 9.X). The size of the cables is given by the following formula:

$$A = \frac{L\rho IC}{V\Delta v}$$

where A is the cable cross-sectional area ( $\text{mm}^2$ ), L its length (m),  $\rho$  its resistance ( $\approx 0.02 \text{ } \Omega \cdot \text{mm}^2/\text{m}$ ), I the current (A), C a coefficient depending on supply, V the nominal voltage (V), and  $\Delta v$  the maximum voltage drop (5%).

$C = 2\cos \phi \times 10$  in case of direct single-phase start.

$C = \sqrt{3}\cos \phi \times 100$  in case of direct three-phase start.

**Table 9.X: Number and cross-sectional area of cables depending on motor power and supply (power lines of 100 m or more).**

**Standard cross-sectional areas: 1.5, 2.5, 4, 6, 10  $\text{mm}^2$ .**

Motor power (kW)	Single-phase 220 V	Three-phase 220 V	Three-phase 380 V
0.55	3 / 1.5 $\text{mm}^2$	4 / 1.5 $\text{mm}^2$	4 / 1.5 $\text{mm}^2$
1.1	3 / 2.5 $\text{mm}^2$	4 / 1.5 $\text{mm}^2$	4 / 1.5 $\text{mm}^2$
2.2	–	4 / 2.5 $\text{mm}^2$	4 / 1.5 $\text{mm}^2$
3.7	–	4 / 2.5 $\text{mm}^2$	4 / 1.5 $\text{mm}^2$
5.5	–	4 / 4 $\text{mm}^2$	4 / 1.5 $\text{mm}^2$
11	–	4 / 6 $\text{mm}^2$	4 / 2.5 $\text{mm}^2$

## 5.2 Generator choice

The generator is chosen on the basis of the characteristics of the pump motor. A three-phase pump is always supplied by a generator providing three-phase current. A single-phase pump can be supplied by a single-phase generator, or preferably by a three-phase one, in order to reduce starting-current problems. A starter box is necessary for single-phase motors.

Theoretical calculations are not sufficient to choose a generator correctly, since they do not take into account their characteristics, which vary depending on the power-generation technology. For relatively low power ranges ( $< 10 \text{ kVA}$ ), an empirical calculation is recommended. For much higher power levels, progressive starting is normally the most suitable solution to solve starting-current problems.

### 5.2.1 THEORETICAL POWER CALCULATION (MOTOR AND GENERATOR)

The characteristics of the SP8A-25 pump motor are given by the manufacturer:

–  $I_{\text{nominal}} = 8.9 \text{ A}$

–  $I_s/I_n = 4.4 (< 6)$

–  $\cos \phi = 0.87$

–  $I_s = 8.9 \times 4.4 = 39.2 \text{ A}$

– power consumed by the pump motor:

$$P = VI \cos \phi = 380 \times 8.9 \times 0.87 = 2.9 \text{ KW}$$

– power required from the generator:

$$P(\text{VA}) = VI = 380 \times 8.9 = 3.4 \text{ kVA}$$

– starting power required from the generator:

$$P(\text{VA}) = VI_s = 380 \times 39.2 = 14.8 \text{ kVA}$$

The power required from the generator that supplies this pump should, according to the calculations, be 14 kVA. In fact, two additional factors are taken into account in the final choice: the starting frequency and the fact that the motor is three-phase, which has a lower starting torque than a single-phase motor.

### 5.2.2 EMPIRICAL CALCULATION

Making an approximation for generators of less than 10 kVA, the power of the generator is twice the nominal pump motor power, plus 25%:

$$P_{\text{gen}} = (P_{\text{pump}} \times 2) + 25\%$$

So, in this example:  $P_{\text{gen}} = (2.9 \times 2) + 25\% = 7.25 \text{ kVA}$ .

## 6 Dewatering pumps

### 6.1 Principle and material

In contrast with standard submersible pumps, these lift pumps are capable of pumping turbid water (containing mud or sand). They are used, for example, for pumping out excavation sites.

This type of equipment is used for pumping out wells, and they are more appropriate for this than motorised surface pumps, which are limited by their maximum suction lift, which is 10 m, and also, for obvious safety reasons, it is absolutely out of the question to lower a motorised pump into a well while diggers are working in it (it would be impossible to evacuate the exhaust gas).

These pumps can also be used for any kind of pumping from a stream, to supply a water-treatment station (emergency water-supply system) or for irrigation.

Experience has led to the development of both electric and pneumatic water pumps.

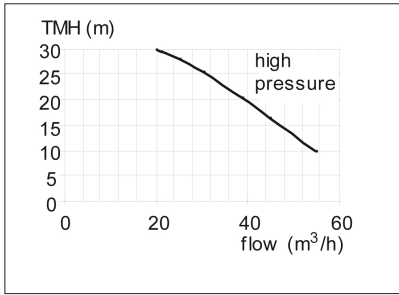
For well digging, pneumatic pumps, despite their cost, (pumps plus compressor) seem to be the most suitable (robust, safe, no electricity at the bottom of the well). They work with a small compressor, providing a minimum of 6 bars and 35 l/s, and can also be very useful on other jobs on the site (e.g. pneumatic hammers).

On the other hand, for any kind of pumping from a stream or river (drinking or irrigation water), electric water pumps are more suitable due to their low bulk, their hydraulic efficiency (TMH-flow) and their lower purchase and running costs (generator consumption is low compared to that of a compressor).

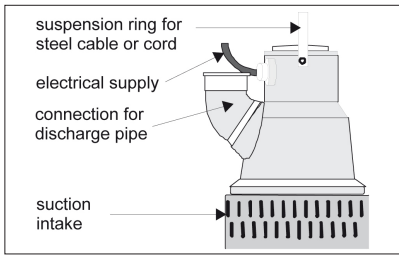
### 6.2 Electric dewatering pumps

The characteristics of the model quoted (Figures 9.16 and 9.17) provide a multi-purpose pump for everyday situations. There are obviously other ranges of pumps depending on specific applications.





**Figure 9.16: Characteristic curve for an electric dewatering pump.**



**Figure 9.17: Electric dewatering pump. Model 2102 HT 234; weight: 50 kg; height and diameter: 660 x 470 mm; discharge diameter: 2"; nominal power: 4.6 kW; supply voltage: 380 V, 50 Hz three-phase or 220 V, 50 Hz three-phase**

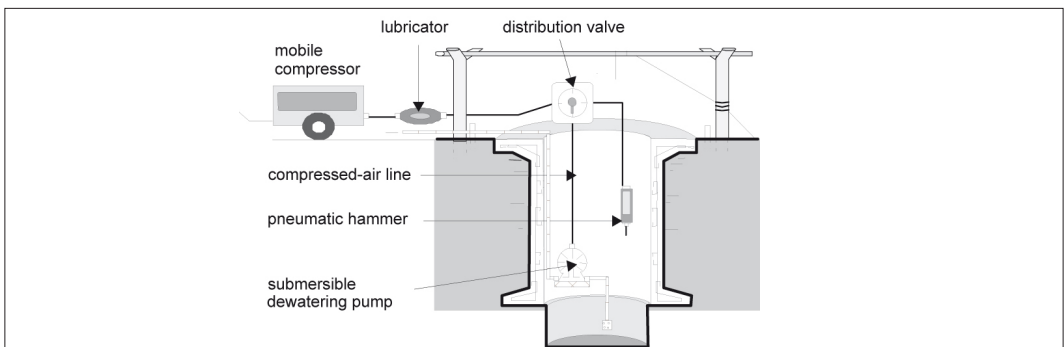
### 6.3 Pneumatic water pumps

Using a pneumatic pump and pneumatic hammer for well digging (Figure 9.18) requires an alternation of pumping phases (pump valve open) and digging phases (hammer valve open). Air containing oil vapour is toxic (masks are needed for workers), and it is advisable to keep lubrication to a minimum. Simple daily lubrication of the equipment will solve this problem.

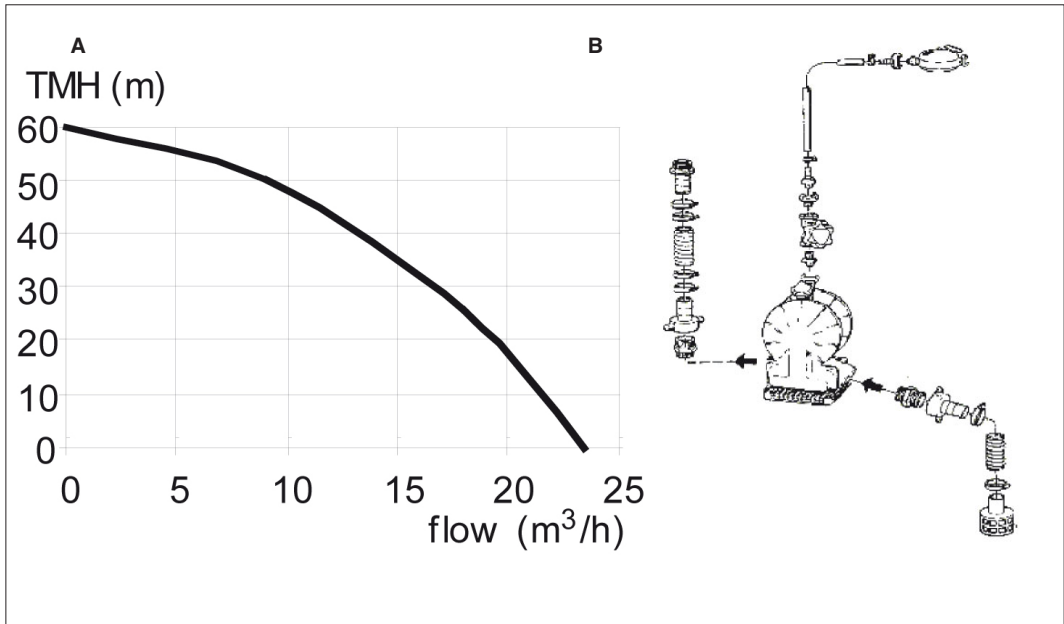
The model selected by ACF is a membrane pump with characteristics as given in Figure 9.19.

## 7 Renewable energy pumps

Nowadays, solar pumping technology is widely available from various manufacturers. It can be useful for water supply to a medium-size village. However, flows and TMH remain limited (a maximum of 100 m³/day/100 m). Also, the area of the solar panels to be installed quickly becomes significant, with consequent increases in cost. Maintenance of these installations must be considered under the same terms as that of a conventional installation, even if the running cost is very low: it is necessary to ensure the availability of spares and the training of technicians for this method. Turning to solar energy must not lead to false ideas about the cost of the water and maintenance of the installation.



**Figure 9.18: Using a pneumatic pump and a pneumatic hammer in well digging.**



**Figure 9.19: Membrane dewatering pump.**

**A: characteristic curve. B: exploded view. Weight: 31 kg; H x W x L: 60 x 40 x 35. Discharge: DN 2.5"; compressed-air pressure 6 bar, flow 34 l/s, air inlet: DN 0.75".**

ACF's experience with pumps using the Nile current at Juba (Sudan) is an alternative which deserves to be presented in this section about pumping with renewable energy.

## 7.1 Solar pumping

### 7.1.1 SOLAR ENERGY

Solar panels convert solar energy (excitation of photons) into electrical energy (excitation of electrons). This energy can be stored in batteries (accumulators) to allow continuous running, or be transmitted directly to the electrical equipment.

There are thus two possible approaches:

- direct solar pumping (Figure 9.20) ;
- battery storage (refrigerator, lighting, radio etc.).

Solar pumping is always carried out directly to avoid the need for accumulators (e.g. batteries), which are costly and have to be changed every two or three years. In a water system, the elevated tank takes on the role of the accumulator:

- the solar panels provide the power needed to drive the pump. Mounting them in series provides the voltage necessary for the converter (the voltages of the modules are added to each other);
- the converter supplies the pump with 220 V a.c. from the direct current provided by the solar panels. The rotor speed and therefore the flow of the pump vary depending on the hours of sunshine, with maximum flow occurring in the middle of the day (strong sunshine).

The electricity produced by the panels is several amps d.c., at a voltage of 12 to 18 V, and, depending on the model, providing power of 60 to 90 Wc (4.86 A, 18.5 V and 90 Wc for the BP Solar 590).

The performance of solar panels depends on the hours of sunshine, angle of incidence, and cell temperature. These parameters depend on latitude as well as on the local climatic and geographic characteristics. A study is always necessary to determine the panel area required.

## 7.1.2 SOLAR PUMPING STATION DESIGN

### 7.1.2.1 Principle

To define the solar panel power necessary for pumping, the geographical situation must be known in order to determine the hours of sunshine and the total solar radiation (HSP: hour sun peak), as well as flow and TMH. The following procedure must be followed:

- definition of the HSP (kWh/m<sup>2</sup>/day), depending on the maximum number of hours of sunshine and length of day. The HSP is therefore defined in relation to the latitude of the site;
- choice of pump depending on flow and TMH (Table 9.XI);
- use of the efficiency charts of the pumps provided by the manufacturer to obtain, depending on the HSP, the necessary power developed by the panels (Wp) to operate the pump in this range of flow and TMH (see Figure 9.21);
- determination of the number of panels:  $W_p/P_n$  (nominal power of each panel);
- verification of the nominal voltage to operate the inverter (depending on model);
- calculation of instantaneous flow at maximum hours of sunshine, using the chart providing flow depending on power  $W_{cc} = 0.8 \times W_p$ .

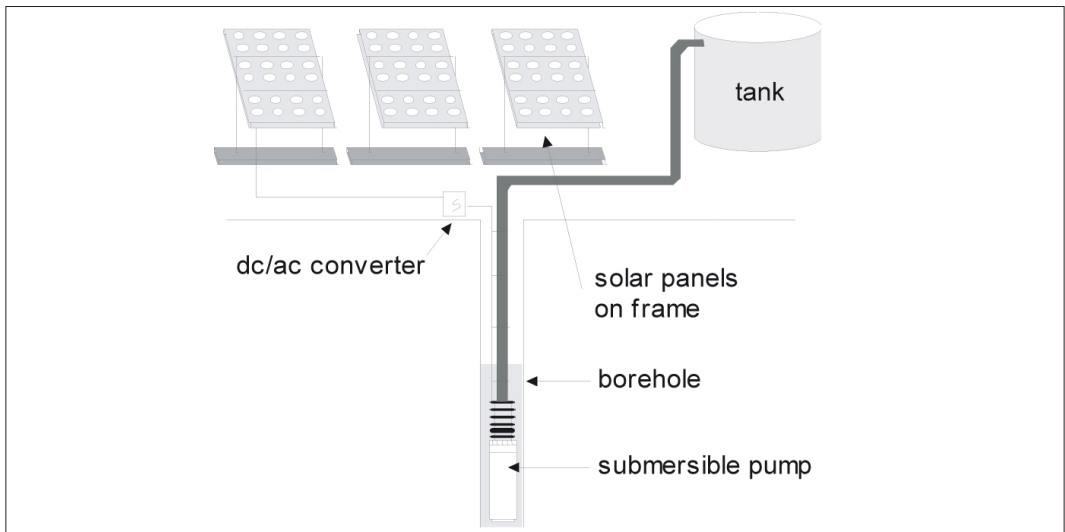
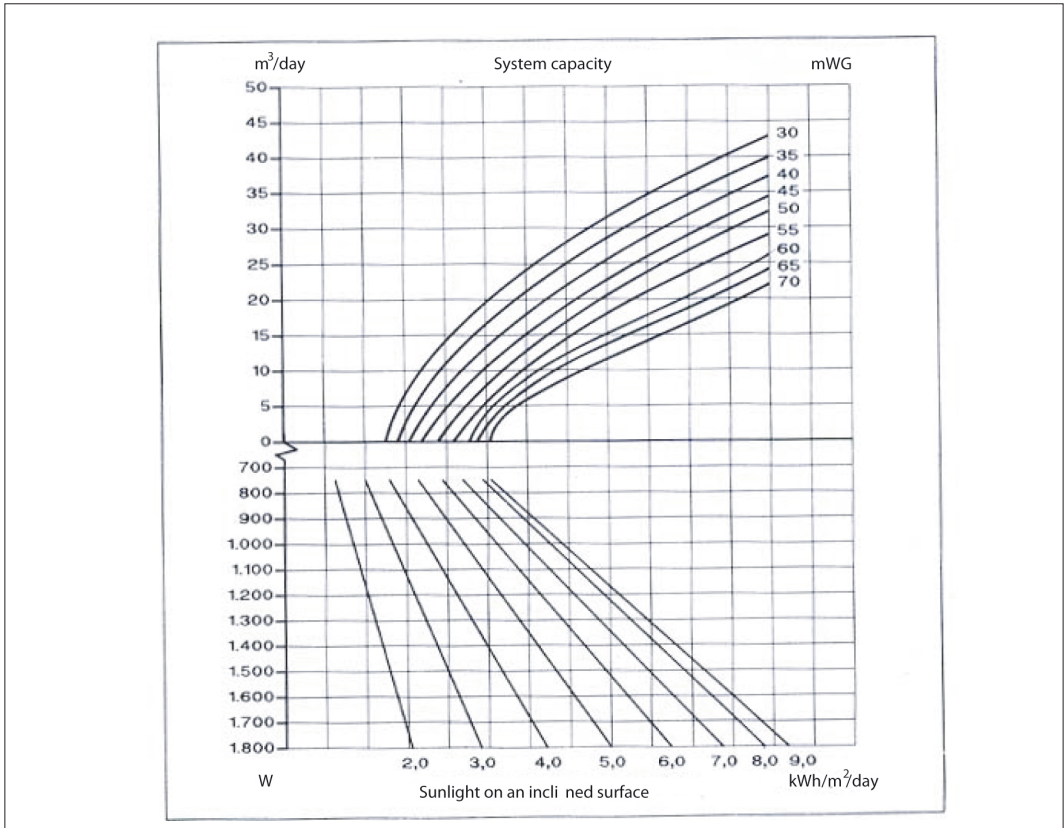


Figure 9.20: Supplying a pump using solar panels.

Table 9.XI: Main Grundfos solar pumps with mean daily flows (HSP 5.7; temp 30°C; 20° N latitude; inclination 20°).

Pump	TMH (m)	Mean daily flow (m <sup>3</sup> /day)
SP1.5A-21	80-120	10
SP2A-15	50-120	15
SP3A-10	30-70	20
SP5A-7	2-50	35
SP8A-5	2-28	60
SP14A-3	2-15	>100



**Figure 9.21: Design chart for SP3A-10 pump for 11 hours of sunshine per day and average temperature of 30°C.**

*7.1.2.2 Example of a pumping station*

Basic data:

- TMH 65 m,  $Q = 10 \text{ m}^3/\text{day}$ ;
- station in Mali,  $\text{HSP} = 5.7 \text{ kWh}/\text{m}^2/\text{day}$ .

In the case of an SP3A-10 pump, the chart in Figure 9.21 gives a useful motor power ( $W_p$ ) of 1 400 W.

To equip the installation with BP Solar 590 panels to provide 90 Wc requires:  $W_p/P_n = 1\,400/90 = 15.5$  panels.

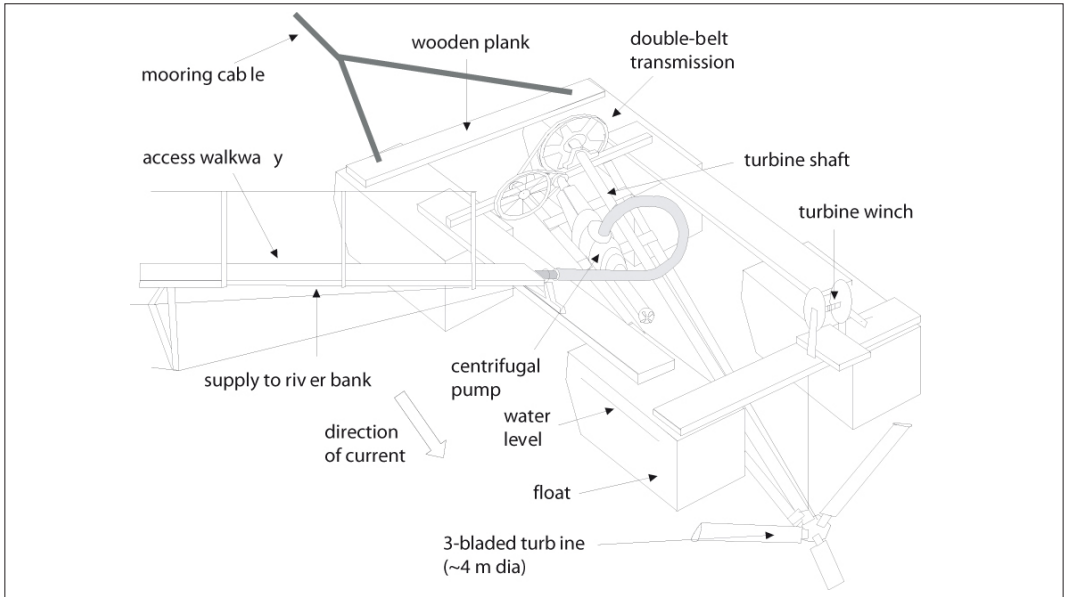
Therefore, with the inverter working under a nominal voltage of 110 V, seven 18-V panels mounted in series are necessary.

The station will therefore be composed of 21 panels, 3 modules (in parallel) of 7 panels each (in series).

Instantaneous flow is  $W_{cc} = 1\,890 (90 \times 21) \times 0.8 = 1512 \text{ W}$ ; according to the chart, the pump will provide  $3.5 \text{ m}^3/\text{h}$ .

**7.2 Hydraulic energy**

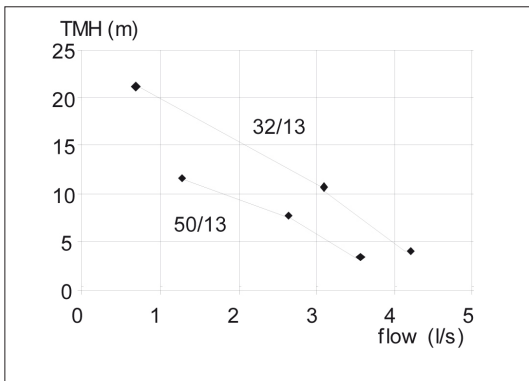
Garman pumps, made under licence in England and Khartoum (Sudan), are centrifugal surface pumps that use the motive force of the current of a river or stream on a turbine to drive the pump shaft.



**Figure 9.22: Garman pump installed on a raft.**

These pumps can work continuously (24 h/24) provided that the watercourse has a minimum speed of 0.85 m/s, and a depth of about 3 m (Figures 9.22 and 9.23). They can be used to provide drinking water, but are especially useful for irrigation water, bearing in mind their low lift height, low running cost reduced to the simple maintenance of the pumps and turbine (blades), and finally the absence of fuel.

The choice of turbine blades depends on the speed of the current and the depth of the watercourse (Table 9.XII).



**Figure 9.23: Characteristic curves for Garman 32/13 and 50/13 pumps.**  
**Current speed: 0.85 – 0.9 m/s; large blades (ACF, Sudan, 1996).**  
**These two pumps mounted in series on the Nile at Juba produced around 2 l/s for a TMH of 25 m.**

**Table 9.XII: Lengths of turbine blades as a function of the characteristics of the watercourse.**

Depth	Speed of the current (m/s)		
	0.7-1	1-1.2	1.2-1.4
2.5 to 3 m	—	—	80 cm
3 to 3.5 m	—	100 cm	80 cm
3.5 to 4 m	120 cm	100 cm	80 cm

### 7.2.1 ROTARY SPEED OF THE PUMP

Here, the rotary speed of the pump depends on the speed of the current, and also on the diameter of the pulleys which transmit that rotation to the pump shaft:

$$\omega_{\text{pump}} = (\phi_1 / \phi_2) (\phi_3 / \phi_4) \omega_{\text{screw}}$$

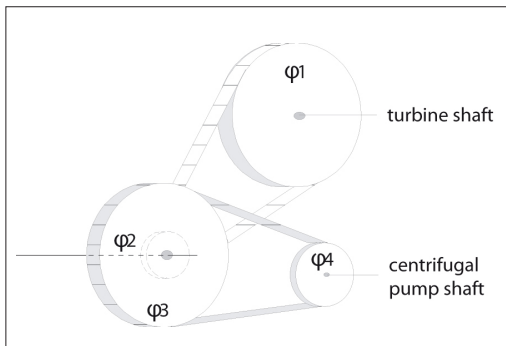
where  $\phi$  is the diameter of the pulleys and  $\omega$  the rotational speed of the shafts (rpm). For example, if the turbines turns at 21 rpm, the pump shaft will turn at 2 320 rpm with the pulley configurations shown in Figure 9.24.

**Table 9.XIII: Adjustment of rotary speed of a Garman pump.**

Ratio	Modification to be carried out
$r < 1.45$	Reduction of pump pulley diameter
$1.45 < r < 1.55$	Acceptable working range; a 1.55 ratio is the best setting
$r > 1.65$	Increase in turbine blade size and pump pulley diameter

### 7.2.2 PERFORMANCE TEST

Empirically, the speed of the turbine shaft is measured in revolutions per minute (rpm) light or under load (pump connected by the set of belts to the turbine shaft). The ratio  $r = \omega_{\text{light}} / \omega_{\text{load}}$  gives the efficiency of the installed pump (Table 9.XIII).



**Figure 9.24: Mounting plan for pulleys.**

Pulley	Diameter (mm)
$\phi_1$	49.5
$\phi_2$	5.6
$\phi_3$	50
$\phi_4$	4

**Table 9.XIV: Components necessary to mount a Garman pump.**

Denomination	Quantity
Type 32/13, 40/13 or 50/13 centrifugal pump	1
Turbine transmission shaft (3" galvanised tube)	1
Long, medium or short blades (80, 100 or 120 cm)	3
Turbine shaft ball bearing	2
Turbine shaft drive belt	1 + spare
Pump transmission belt	1 + spare
Intermediate shaft roller bearings	2
Large pulley	2
Stainless steel winch cable	1
Intake non-return valve with screen	1
Pump pressure gauge	1
Raft for pump installation	1
Steel mooring cable	1
Access walkway	1

### 7.2.3 COMPONENTS OF A GARMAN PUMP

The list of components is given in Table 9.XIV. The price of a Garman pump, made in Khartoum, is about USD 2 000.

## 8 Handpumps

Handpumps are normally used for boreholes and wells. They allow wells to be sealed against contamination and, in many cases, may increase the amount of water lifted.

Most handpumps are volumetric pumps with a submerged piston, controlled by a mechanical linkage or a hydraulic one (system developed by A. Vergnet). Some of them can pump water to a height of more than 60 m.

Several types of durable handpump have been developed to meet field conditions, especially intensive use. The choice is carried out on the basis of technical and socio-economic criteria (Table 9.XV).

**Table 9.XV: Selection criteria for pump installation.**

Technical criteria	Socio-economic criteria	
Pumping depth and desired flow	Existence of a spares distribution network	
Pump diameter	Pump tested and accepted by the population	
Ease of installation and maintenance	Pumps already installed in the zone	
Durability and reliability of the pump	State or inter-agency directives	
Type of pumping:	Cost	
– lift to reservoir		
– drive by motor + belt possible		
Type of pump	Diameter of pipes (borehole)	
Suction pump type VN6	2"	DN 50 (52 mm interior)
Vergnet 3C	3"	DN 75 (82 mm interior)
Other pumps	4"	DN 100 (103 mm interior)
Kardia K65	4"1/2	DN 115 (113 mm interior)

### 8.1 Main types of handpump

Handpumps are classified according to their installation depth (Table 9.XVI): suction pumps for dynamic levels less than 7 m; lift pumps for dynamic levels greater than 7 m; pumps adapted to

**Table 9.XVI: Usual working range of handpumps.**

	10 m	20 m	30 m	40 m	50 m	60 m	70 m	80 m	90 m	100 m
..... Tara .....										
.... Vergnet HPV 30 ....										
..... India Mark 2 .....										
..... Aqua/Afridev .....										
..... Kardia .....										
..... Vergnet HPV 60 .....										
..... Volonta .....										
..... Monolift .....										
..... Vergnet HPV 100 (*) .....										

\* 2 persons pumping.

great pumping depths (> than 35 m). Vergnet and Monolift pumps also have the capacity of delivering water to elevated tanks (this requires pump-head sealing).

The working flows of handpumps vary depending on the installation depth and the type of pump. For example:

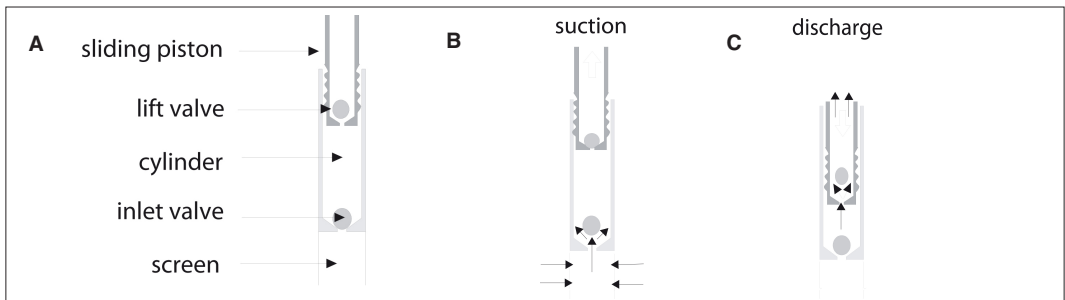
- Aquadev pump installed at 15 m: 1.4 to 1.8 m<sup>3</sup>/h;
- VN6 suction pump at 6 m: 1.5 to 1.8 m<sup>3</sup>/h;
- HPV 60 Vergnet pump at 35 m: 1 m<sup>3</sup>/h.

Mean flows, depending on pumping rate (strokes per minute), are given by the manufacturers.

## 8.2 Piston pumps

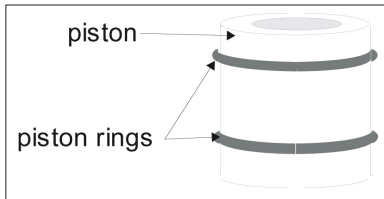
### 8.2.1 SUBMERGED PUMPS

The working principle of these pumps is described in Figure 9.25. The various submerged elements are presented in Figure 9.27.



**Figure 9.25: Working principle of a piston pump.**

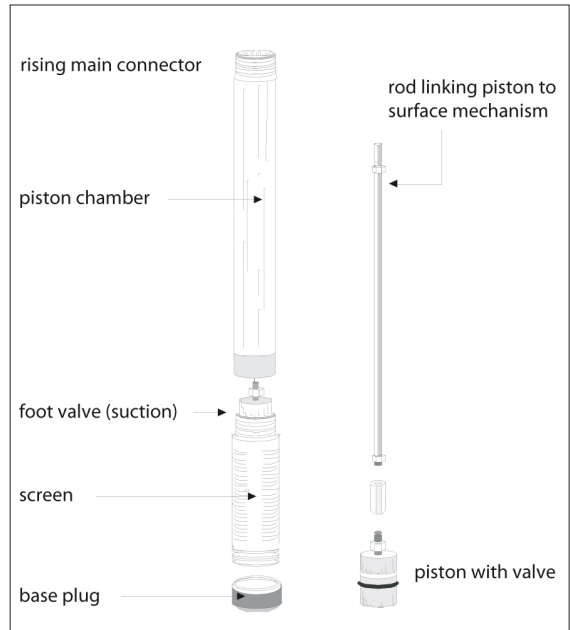
**A: outline principle. B: piston rises, inlet-valve opens, lift-valve closes, chamber fills with water. C: piston falls, lift-valve opens while inlet-valve closes, chamber empties.**



**Figure 9.26: Piston sealing – piston rings.**

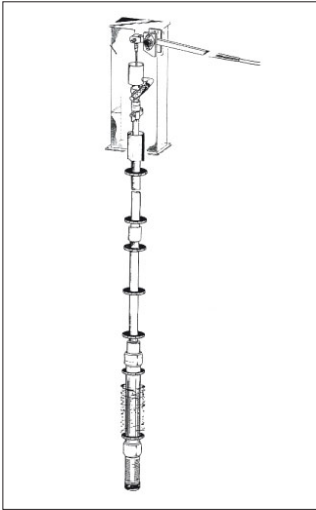
The rings which ensure piston/cylinder sealing (Figure 9.26) are subject to continuous friction, and are therefore wear components. Some manufacturers have eliminated them (hydraulic seals).

There are all sorts of valves used in handpump cylinders (Figure 9.27). Any valve malfunction can mean a drop in pump



**Figure 9.27: Kardia pump cylinder.**

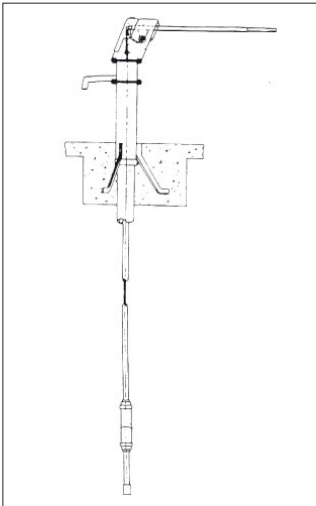




Examples of piston lift pumps are given in Figures 9.28 to 9.31.

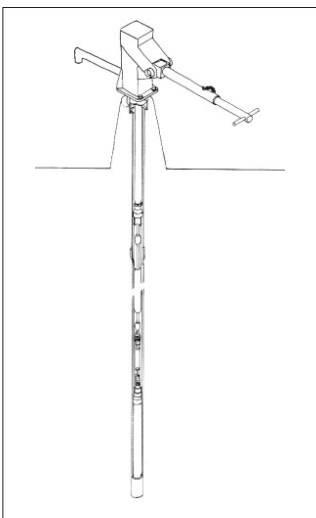
**Figure 9.28: Kardia K65 and K50 pumps (for very large depths).**

Manufacturer	Preussag AG
Pump head and handle	Galvanised steel
Pump rods, rising main	Screwed stainless steel and PVC tubes
Pump body	Stainless steel
Piston, cylinder	PVC
External diameter	K 65: 70 mm; K 50: 50 mm
Total weight (25 m)	110 kg
Price	2400 euros ex-works (45 m)
Performance (40 strokes/min)	K 65: 1 m <sup>3</sup> /h at 30 m; K 50: 672 l/h at 45 m
Advantages	Excellent corrosion resistance Ease of installation (screwed PVC) Good manufacturing quality
Disadvantages	Frequent loosening of the handle ball-bearing Fixing screws (use a product such as Frenbloc) High purchase cost



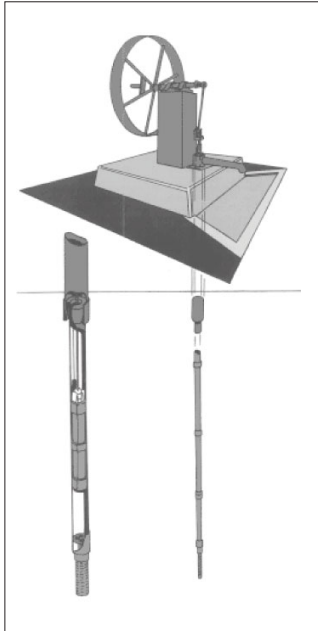
**Figure 9.29: India Mark II pumps.**

Manufacturers	Local, or French (Soverna)
Pump head	Galvanised steel
Pump rods, rising main	Galvanised steel
Pump body	Varies with manufacturer: stainless steel (Mali) or galvanised steel (India)
Total weight	120 kg for 25 m
Price	600 – 750 euros (25 m)
Performance (40 strokes/min)	700 l/h at 25 m
Advantages	Subsidised by UNICEF, low purchase cost
Disadvantages	Problems with transmission chain Tripod recommended for installation (heavy pump) Mark III version too heavy (pipes in 3" G.I.)



**Figure 9.30: Aquadev and Afridev pumps.**

Manufacturers	Aquadev-Mono pumps (England), or local (Kenya, Mozambique)
Pump head	Microwelded stainless steel
Pump rods, rising main	Steel and PVC
Pump body	PVC
Piston	Synthetic
Total weight	100 kg for 25 m
Approximate price	750 euros ex-works (25 m)
Performance (40 strokes/min)	1.3 m <sup>3</sup> /h
Advantages	Good manufacturing quality with Aquadev Piston and foot valve completely demountable without removing PVC outlet pipe
Disadvantages	PVC column fixed with adhesive thus difficult to remove PVC quality poor, depending on manufacturer (Afridev) Afridev rod-fixing brackets unreliable



**Figure 9.31: Volanta handpump.**

Manufacturer	Jensen Venneboer (Netherlands)
Pump stand	Mild steel painted
Flywheel	Mild steel painted
Rising main	PVC
Pump cylinder	Reinforced epoxy resin
Plunger / pump rods	Stainless steel
Valves	Rubber
Total weight	700 kg
Approximate price	3 500 euros (without pipes)
Discharge at 75 watts	20 m head: 1.5 m <sup>3</sup> /h, 50 m head: 1 m <sup>3</sup> /h, 80 m head: 0.5 m <sup>3</sup> /h
Pumping lift	10 – 80 m
Advantages	Good quality materials, durability, strength It allows water to be lifted to elevated places and to be pumped to a safe distance from the well (decreasing the risk of contamination of the water point, useful for cattle watering) Can be coupled with a windmill or motor
Disadvantages	High cost Difficult local manufacture Difficult to handle by children Requires very clean water or the piston can block

Examples of piston lift pumps are given in Figures 9.28 to 9.31.

### 8.2.2 SUCTION PUMPS

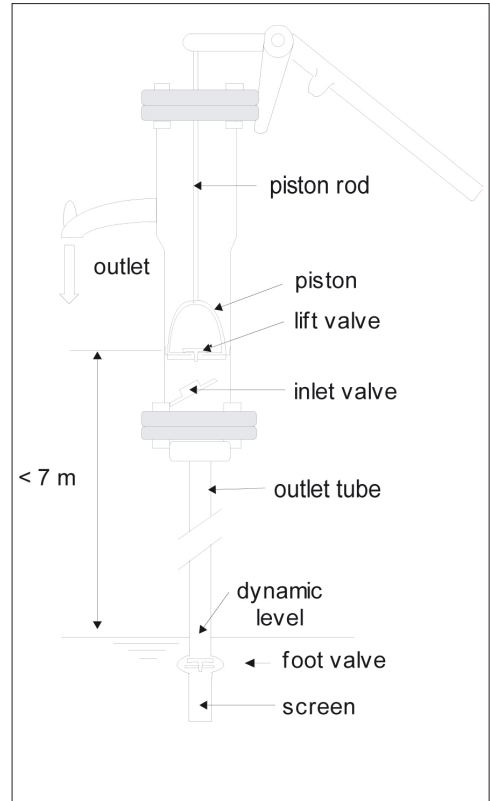
The VN6-type suction piston pump is made locally in South-East Asia (Figure 9.32). Its simplicity in design and manufacture make it a pump which is very cheap (USD 30), but it suffers frequent pump-body fractures (poor quality). Manufacturing quality varies depending on country (Bangladesh, Vietnam, Myanmar). Its use is possible up to dynamic levels of 8 to 9 m, with the installation of a supplementary foot valve, because the valve in the cylinder is usually of poor quality. A steel pedestal, to which the shoulder bolts are screwed, is necessary, to

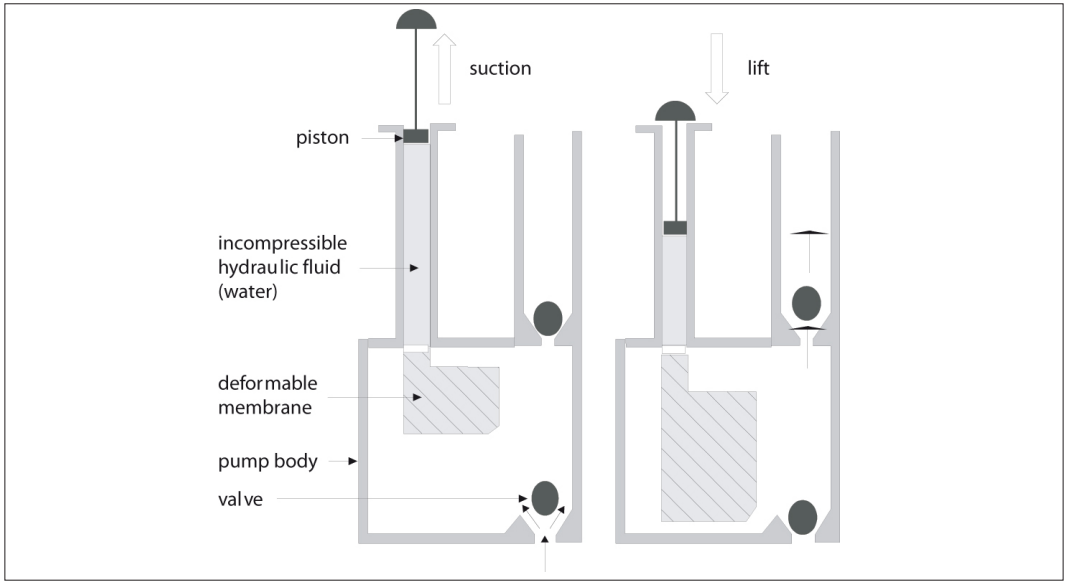
**Figure 9.32: VN6-type suction pump.**

avoid embedding the bolts in the baseplate.

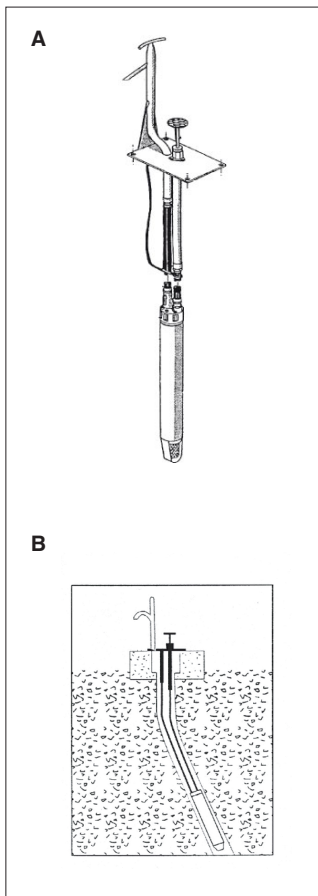
### 8.3 Hydraulic pumps

Hydraulic pumps, developed principally by Vergnet SA, are lift pumps which work with a hydraulic transmission between the submerged cylinder and the pump head, which reduces the number of moving parts (Figure 9.33). There are





**Figure 9.33: Working principle of Vergnet hydropump.**



three models: HPV 30 - 60 - 100.

The balloon, a deformable rubber cylinder, varies in volume inside a sealed pump body (Figure 9.34 A). The controls are hydraulic, since the balloon is deformed by the water pressurised from the surface by the piston (pedal).

The HN30 and the Hydro India work on the same principle but are

**Figure 9.34: Vergnet hydropump.**

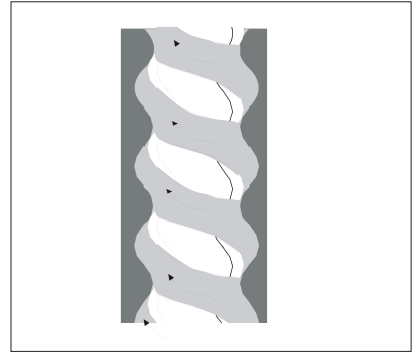
**A: HPV 60. B: Hydro India 60.**

Pump head	Galvanised steel
Pedal cylinder	Stainless steel
Control tube	High-density polythene
Rising main	High-density polythene
Pump body	Stainless steel
Cylinder	Stainless steel
Balloon	Rubber
Valves	Ball type
Total weight	45 kg for 25 m
Prices	950 euros (HPV 30), 1 300 euros (HPV 60) 2 500 euros (HPV 100)
Performance	1.3 m <sup>3</sup> /h at 30 m, 0.8 m <sup>3</sup> /h at 70 m, 0.7 m <sup>3</sup> /h at 90 m
Advantages	Working in boreholes that are out of alignment (see Figure 3.34 B), excellent corrosion resistance, ease of installation and repair Few wear components, simple assembly and disassembly, very low weight pumps, good quality/price ratio
Disadvantages	Auto-cut-off on recent models; frequent power loss on hydraulic control On older models, balloon expensive but guaranteed 3 years Pedal action sometimes poorly regarded by certain communities

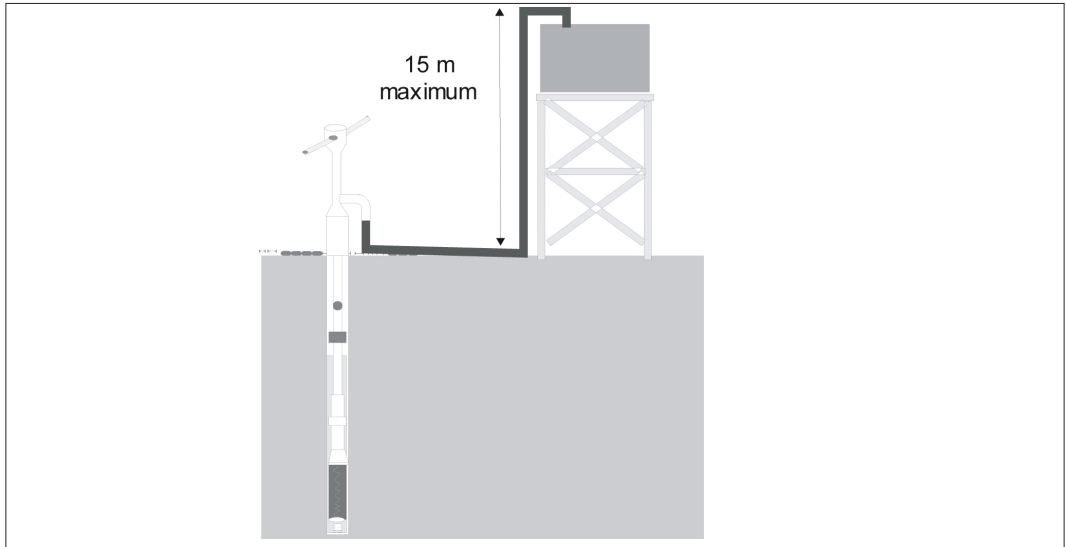
worked with a handle (hand) and not a pedal (foot), Figure 9.34 B.

## 8.4 Helical rotary pump

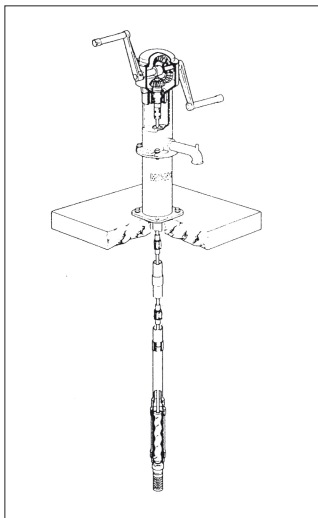
This pump, also known as a progressive cavity pump, works on the principle of volumetric variation. The pumping element (hydraulic part) incorporates a helical rotor in iron alloy, which turns inside an elastic stator with



**Figure 9.35: Helical rotor of the Monolift pump.**



**Figure 9.36: Pumping to a tank using a Monolift pump.**



**Figure 9.37: Characteristics of the Monolift pump.**

Manufacturer	Mono Pumps (England) or Euroflo Pumps (S Africa)
Superstructure	Cast iron
Main shaft	Stainless or galvanised steel
Rising main	Galvanised steel
Pump body, rotor	Chrome-plated brass
Stator	Steel and rubber
Foot valve	Polythene
Total weight	420 kg for 60 m
Approximate price	1 950 euros ex-works (60 m)
Advantages	Robust and very suitable for large depths Simple drive
Disadvantages	Possibility of lifting water to 15m above the pump Fragile angle-gear drive (gear breakage) Handle difficult to turn (sometimes impossible for children), liable to corrosion

a double helix (Figure 9.35). The rotor is operated from the surface by a shaft guided by a bearing.

## 8.5 Rope-and-washer pump

The rope-and-washer pump is a low-cost technology used at the community and family level. Bombas Mecate S.A. converted this traditional water-pump technology into an inexpensive, durable, and highly efficient water-raising system, taking advantage of the availability of PVC pipe and injection-moulded plastics.

It is usually installed in dug wells and boreholes (100 mm diameter minimum) but it is also possible to install it in riversides. Other advantages are the possibility of installation in non-vertical wells (there is no need to install the pumping pipe vertically) and the adaptation of the system to fill elevated tanks. Designs also can be adapted for irrigation purposes (increasing the size of the washers to increase the yield).

This simple technology has been widely applied in rural Nicaragua and it was disseminated in a very short time over the whole country and other parts of Central America. ACF, as well as other organisations, is already introducing this pump to other countries and it is also supporting local manufacture, adapting the design through small modifications. ACF has promoted the rope-and-washer pump in Nicaragua, Guatemala, Honduras, El Salvador, Colombia, Angola, Guinea Conakry (in process), Mali (in process) and Myanmar (in process), and is studying the possibilities in other countries.

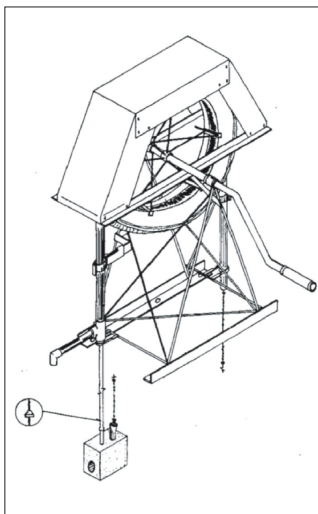
The rope-and-washer pump features a design in which small plastic washers are lined up on a rope (Figure 9.38). The rope is pulled through a plastic rising pipe over a crank-operated drive wheel. The pump stand is of painted mild steel and the drive wheel consists of cut old tires. A ceramic guide box leads the rope with the pistons into the rising pipe (in some places this part is made with part of a glass bottle). This pump is reasonably corrosion resistant. There also exists an adapted design to install in boreholes.

This pump can be powered by hand, animal traction, a stationary bike, wind, or a petrol engine. It can be operated by the whole family for their daily needs, for small agricultural production or for cattle watering.

The rope-and-washer pump requires simple maintenance and has an excellent potential for local manufacturing.

The manufacture requires:

– a plastic injection machine for the washer production - (high density polyethylene is used as



**Figure 9.38: Rope pump.**

Manufacturers	Rope Technology Transfer Division, Bombas Mecate SA, local manufacturers
Pump stand	Painted steel
Crank	Painted steel pipe
Drive pulley	Rubber and mild steel
Washers	Polyethylene
Guide box	Ceramic and PVC
Rising main	PVC pipe
Approximate price	Around 100 euros
Approx. discharge at 75 watts	10 m head: 1.4 m <sup>3</sup> /h 15 m head: 1.1 m <sup>3</sup> /h 30 m head: 0.7 m <sup>3</sup> /h
Maximum depth	40 metres standard. 60 metres with double crank.
Advantages	Easy operation and maintenance by communities. Low cost and possibility of local manufacture.
Disadvantages	Sometimes it is difficult to convince authorities that it is appropriate

raw material);

– the purchase of ropes (manufacture is more complicated);

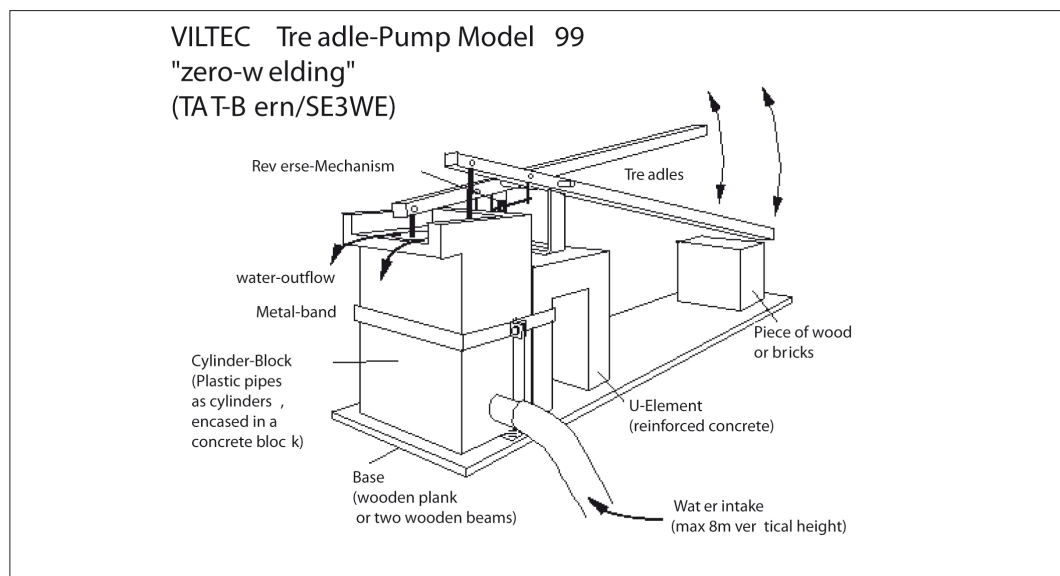
– a guide box made with an entrance pipe, a pumping pipe, a ceramic fitting (the first ceramic fitting is made manually in order to prepare a mould for production pieces), a base and concrete casing;

– the construction of the wheel, pulley and structure with metallic materials.

*Note.* – Low-cost technology facilitates long-term maintenance, but does not guarantee effective maintenance on its own. Often, cost is not the only factor that blocks repairs, community mobilisation remaining the main constraint.

## 8.6 Treadle pump

Treadle pumps are a very efficient solution for irrigated agriculture. Their low cost makes them accessible to even poor farmers. The development of treadle pumps started in Bangladesh, and since a few years they have spread to several countries in Africa (ACF exported these pumps from South



**Figure 9.39: Treadle pump (Viltec treadle-pump model 99 “zero welding”).**

Manufacturer	Diverse (South Africa, Ethiopia)
Cylinders	Metal
Pistons	Rubber
Treadles	Wood (other material is possible)
Support structure	Metal (other material is possible)
Suction pipe diameter	75 mm
Price (2003)	20 – 150 euros
Discharge	3 to 10 m <sup>3</sup> /h depending on cylinder diameter and pumping depth
Area irrigated	0.4 hectares
Maximum suction lift	Approximately 6 m
Maximum discharge lift (for pressure model)	10 – 15 m
Advantages	Low cost Discharge Easy operation and maintenance Good manufacturing quality
Disadvantages	Limitation of suction lift (6 m) Need of standard replacement parts

Africa to Angola in a irrigation project with small farmers in Matala).

The treadle pump is a suction pump that consists of two metal cylinders with pistons that are operated by a natural walking motion on two treadles (Figure 9.39). The treadles and support structure are made of bamboo or other inexpensive locally-available material. Metallic materials can also be replaced by others (plastic etc.) to prevent corrosion. The efficient step-action operation makes it possible to pump the large volumes of water necessary for irrigation. There are also discharge treadle pumps that allows water to be lifted above the level of the pump. Water can be lifted to elevated places and can be pumped through pipes over long distances (up to 500 m).

All household members are able to operate the pump, and it is strong and easily maintained with standard replacement parts available in local markets at a low cost. The pump can be manufactured locally in simple metalworking shops.





# Springs

## A CATCHMENT AND STORAGE TANK DESIGN

<b>1</b>	<b>Spring catchments</b>	363	<b>2</b>	<b>Storage tanks</b>	368
1.1	Flow measurement	363	2.1	Tanks on spring catchments	368
1.2	The hydrogeological context	363	2.2	Tanks with gravity network	369
1.3	Spring catchments	364	2.3	Tanks in pumped systems	370
1.4	Equipping springs	367	2.4	Rainwater-catchment tank	370
			2.5	Tanks for run-off catchment	371

### 1 Spring catchments

Generally, springs offer high quality groundwater that is easy to exploit. They are frequently used in a traditional manner.

#### 1.1 Flow measurement

Flow measurements are required to estimate the yield of springs over the year. For accuracy, it is essential to take measurements over a period long enough to take account of flow fluctuations\*. In practice, it is often impossible to obtain quantitative information on flow over a long period, but local communities have a good knowledge of the behaviour of springs. It is therefore essential to carry out a field investigation in the company of a local person.

From the measurements carried out and the information provided by users, minimum and normal flows can be estimated. The minimum flow is compared to the demand of the population and forms the basis of the decision as to whether or not to build a storage tank. The normal flow forms the basis for overflow design.

Flow-measurement techniques are given in Chapter 3.

#### 1.2 The hydrogeological context

At the time of the preliminary visit, it is important to identify the hydrogeological context of the spring's discharge zone (see Chapter 3). In general, the following types may be defined:\*\*

- fracture springs, for instance emerging through cracks widened by the roots of a tree. These springs may be artesian, but their discharge zone is generally clearly delimited, and the use of a spring box may be envisaged;

\* A flow measurement period of sufficient length also gives the curve of the spring yield reduction, and provides information on the system's reserves.

\*\* This classification does not correspond to the one commonly used in hydrogeology (artesian springs, overflow springs, emergence springs and discharge springs), which in practice does not have much application in the field.

- lowland springs, typical of bedrock zones, corresponding to the outcrop of an aquifer in a topographic depression. The discharge of these springs is often diffuse, and catchment via a drain or well is generally recommended;
- springs on slopes, that are often at a point where the piezometric level (unconfined aquifer) or the aquifer roof (confined aquifer) meets the topographic surface. The discharge zone of these springs is frequently diffuse, except in the case of ravines.

A summary geological section can be drawn to visualise the hydrogeological context.

It is also important to find the initial discharge of the spring, which may be concealed by debris, in a swampy zone, or in very uneven terrain. Again, the discharge zone may vary during the year. Site inspection must therefore be meticulous.

Some simple indicators also help to determine the context:

- seasonal flow variations give a picture of the system’s inertia, and therefore of its transfer rate (transfer of pressure or flow);
- the response of the spring to an isolated downpour can provide an estimate of the response of the system to an impulse, and therefore its vulnerability;
- variations in water quality, especially turbidity, complement this information.

### 1.3 Spring catchments

The objective is to obtain maximum yield from the spring while protecting it from external pollution, especially of faecal origin.

Every spring catchment is a special case: it is not possible, therefore, to offer a model adapted to all situations. There are however two basic types, each corresponding to particular field constraints (Table 10.I).

The choice of catchment technique is determined during the site visit, but is mainly decided during the progress of excavation. The procedure is as follows:

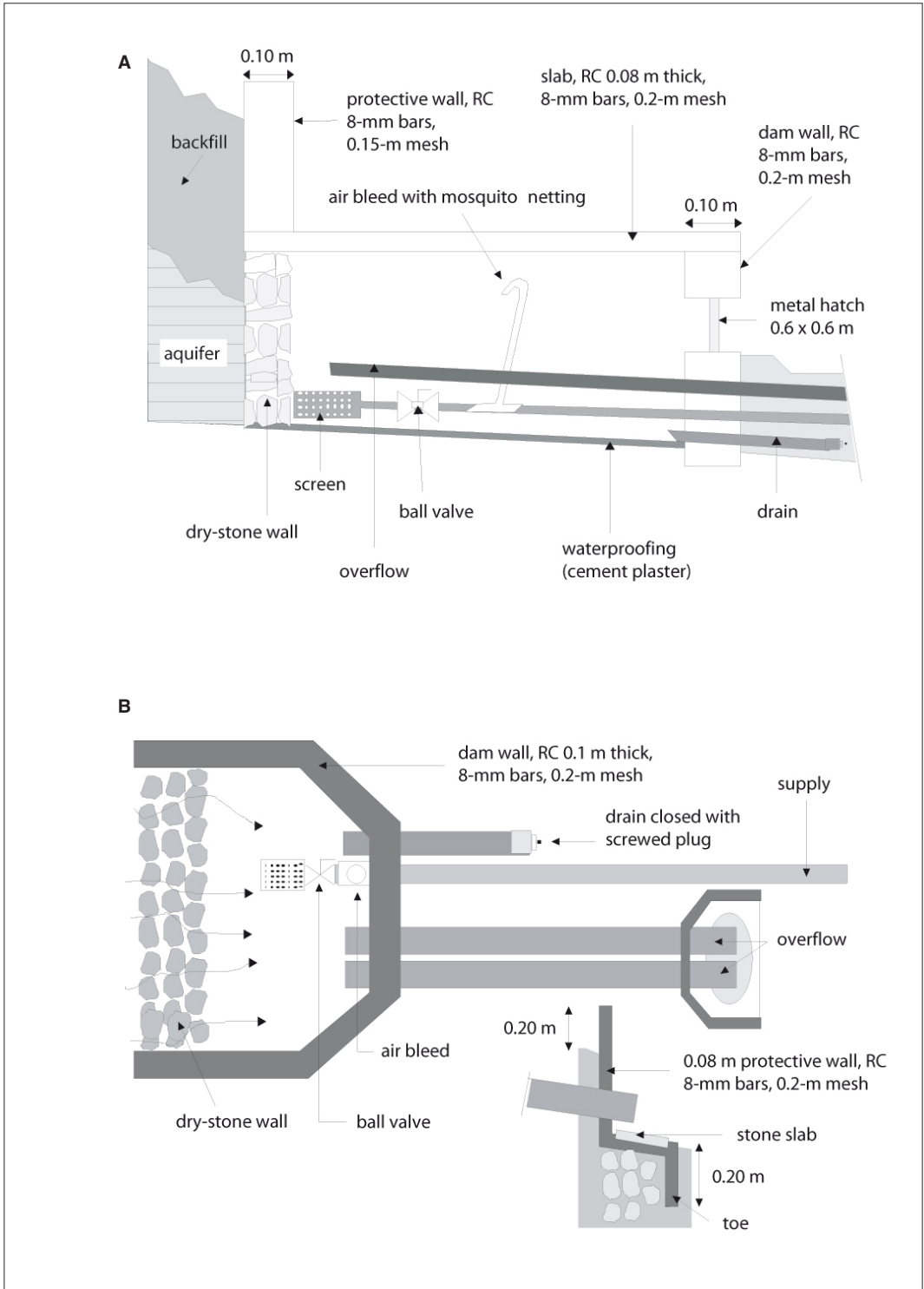
- clear the discharge zone to locate the water outlets precisely;
- excavate towards the source of the water, taking care not to obstruct the flow;
- stop excavation when the impermeable level is reached:
  - if the discharge is clearly localised and not very deep (less than 2 m), construct a spring box and retaining wall to protect the structure;
  - if the discharge is diffuse and/or deep, construct a dam wall with a drain behind it;
- position outlets and overflows correctly below the discharge level;
- erect a protective fence.

Figures 10.1 and 10.2 show the principles of spring catchments using tanks and drains.

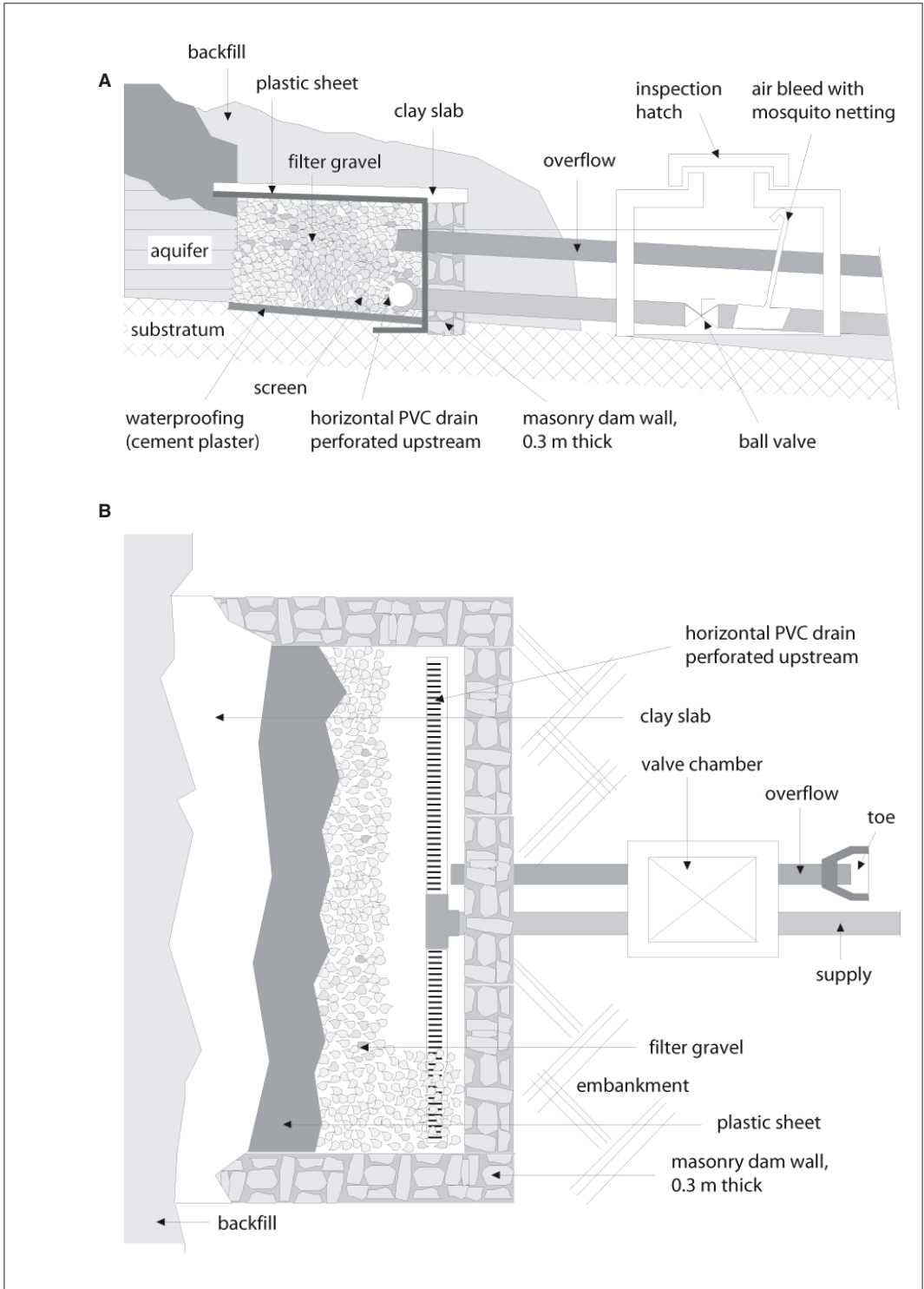
Structures, notably the drain dam wall or the spring box can be made of masonry or reinforced concrete. Infiltration galleries consist of 5-10 cm round pebbles, set behind the wall or in a gabion. A perforated PVC pipe can be laid in the drain to decrease head-losses.

**Table 10.I: Spring-catchment techniques.**

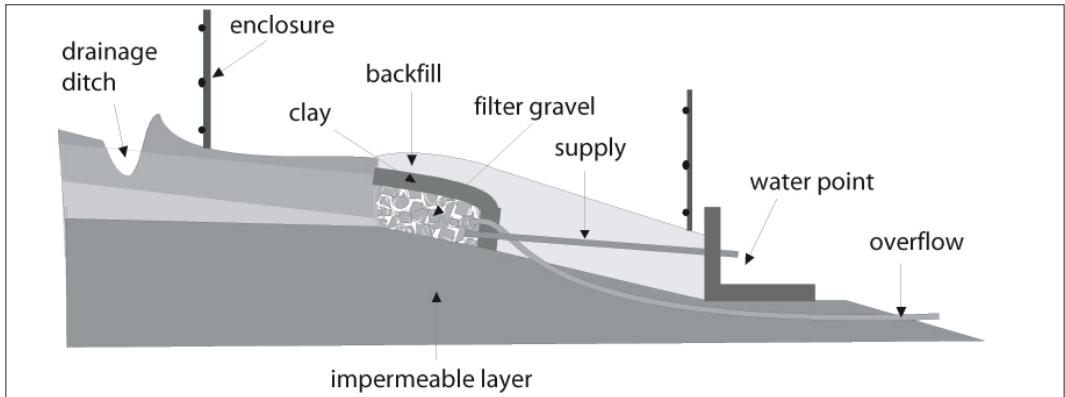
Catchment technique	Type of spring	Advantage	Disadvantage
Spring box	Discharge zone localised and not very deep	Catchment accessible	Often requires major construction work
Infiltration gallery	Discharge zone diffuse and/or deep	Easy to achieve	Catchment inaccessible



**Figure 10.1: Spring box in reinforced concrete.**  
**A: section. B: plan.**



**Figure 10.2: Infiltration gallery.**  
**A: section. B: plan.**



**Figure 10.3: Infiltration gallery sealed with clay.**

The technique of catchment by infiltration galleries sealed with clay (Figure 10.3) is currently used in zones where clay is extracted from the excavation (ACF, Rwanda and Burundi, 1996).

Three rules must be strictly observed in order to construct a reliable spring catchment:

*The catchment must never be subject to back-pressure:* the water level in the spring box or infiltration gallery must always be below the initial discharge level. The catchment must drain the aquifer while allowing extraction from the piezometric level, but must not increase pressure, or the spring could be lost. A reference peg can be used (set far enough away not to interfere with the excavation) to mark the initial discharge level. This acts as a reference mark at the time of the construction: the outlet and overflow are set below this level. However, to avoid accidental back-pressurisation, it is essential to create an overflow; in the absence of information on the maximum flow, the overflow must be over-sized (two or three 3" pipes).

*The dam must be located on impermeable terrain:* the excavation must reach down to the substratum. This sometimes requires substantial excavation, but is essential to ensure that water does not pass under the catchment after some weeks of use. The notion of *substratum* is sometimes difficult to define on site: it is therefore preferable to retain an idea of a less permeable layer over which water moves.

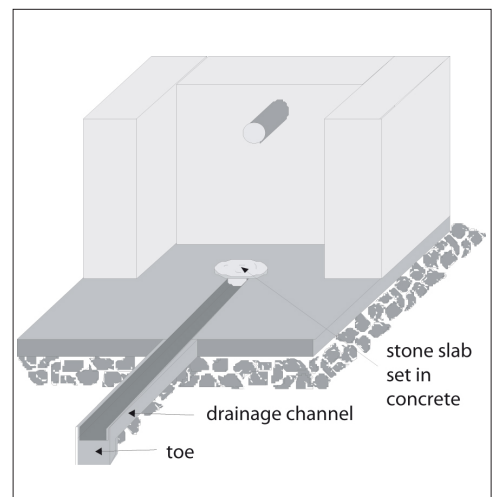
*The catchment must be protected:* the protective works are part of the catchment works. It is necessary to take care over sealing, especially the drain cover (clay, plastic sheeting etc.), and the construction of the tank.

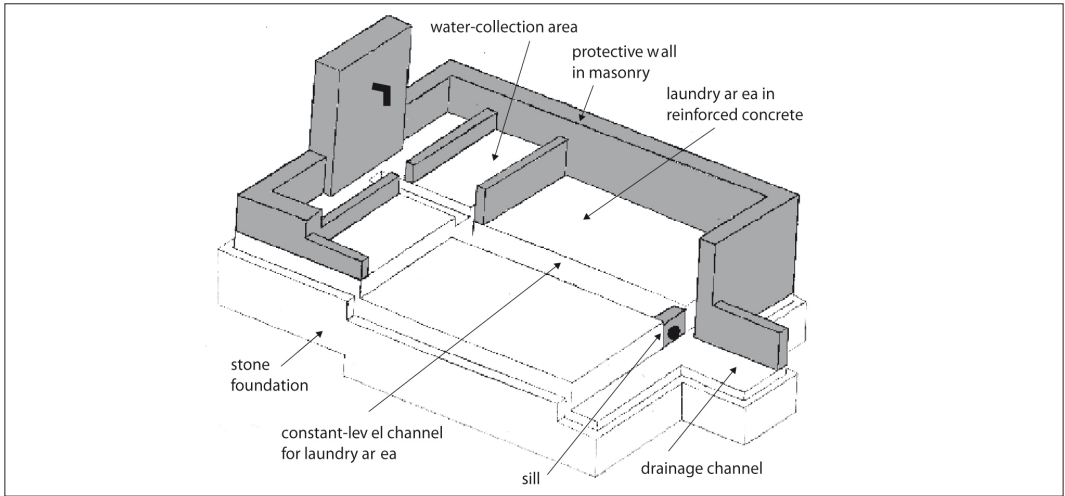
## 1.4 Equipping springs

Springs should be equipped in such a way as to guarantee protection and ease of use. Establishing a protective zone is described in Annex 10. There are many models of water points for springs (Figure 10.4): the choice must be made in agreement with the users, taking account of cultural factors. It is also necessary to study site drainage so as to avoid the development of boggy ground and stagnant water.

Construction details are given in Annex 14.

**Figure 10.4: Examples of water points.**  
**A: simple water point (ACF, Burundi, 1995).**





**Figure 10.4: Examples of water points.**  
**B: water point with laundry area (ACF, Ethiopia, 1993).**

## 2 Storage tanks

### 2.1 Tanks on spring catchments

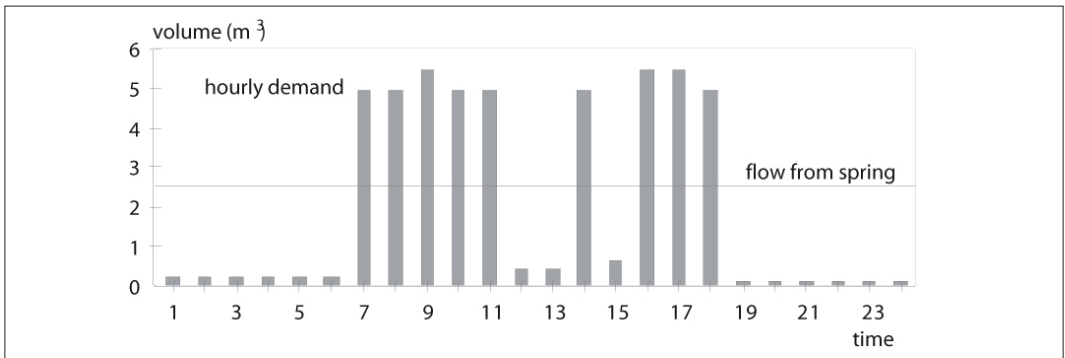
When the maximum hourly demand is greater than the volume produced by the spring in one hour, it is necessary to construct a storage tank. The principle is to store water in periods where demand is low, so as to be able to provide a greater flow when demand increases. The difference between demand and flow of the spring at various times of day is shown in Figure 10.5 (from the example of the Aloua system shown in Chapter 11).

Depending on the capacity of the spring, an open (continuous flow) or closed distribution system with taps and a tank may be considered:

- maximum hourly demand ( $\text{m}^3/\text{h}$ ) < spring flow ( $\text{m}^3/\text{h}$ )  $\rightarrow$  open circuit without a tank;
- maximum hourly demand ( $\text{m}^3/\text{h}$ ) > spring flow ( $\text{m}^3/\text{h}$ )  $\rightarrow$  closed circuit with a tank.

Calculation of tank capacity facilitates economic design. It is therefore important in larger installations (see Section 2.2).

For springs with very low flow-rates, it is taken as a first approximation that the volume of the tank must be equal to the volume of water produced by the spring overnight.



**Fig 10.5: Hourly demand vs. flow from a spring.**

## 2.2 Tanks with gravity network

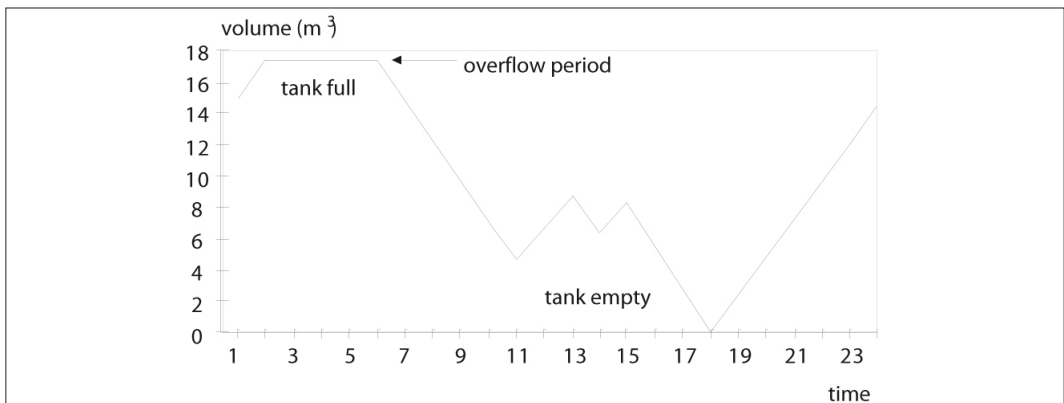
When the spring has to supply a larger population via a distribution network, it is important to optimise tank design. The breakdown of demand into hourly sections is calculated using a consumption coefficient for every period (percentage of total consumption over 24 h). Table 10.II shows an estimate for the Aloua system. The most economical volume of the tank is the minimum required to cover the hourly demand. If this tank volume allows most of the yield of the spring to be used, then a larger tank (optimal volume) should be built – 28 m<sup>3</sup> and not 17 m<sup>3</sup> in our example.

Levels of water in the tank based on time of day can be represented in the form of curves or given in a table. Table 10.III and Figure 10.6 are based on the Aloua example, assuming an empty tank at 18h00 and a volume of 17.5 m<sup>3</sup>.

**Table 10.II: Calculation of demand in hourly periods.**  
**Aloua (Ethiopia), January 1995: flow 2.52 m<sup>3</sup>/h; daily demand 49.56 m<sup>3</sup>/day.**

Period (h)	Coefficient of consumption (%)	Demand over the period (m <sup>3</sup> )	Production of the spring (m <sup>3</sup> )	Stock in the tank (m <sup>3</sup> )
0-6	2.5	1.24	15.12	13.88
6-7	10	4.96	2.52	11.44
7-8	10	4.96	2.52	9.00
8-9	11	5.45	2.52	6.07
9-10	10	4.96	2.52	3.63
10-11	10	4.96	2.52	1.19
11-13	1.75	0.87	5.04	5.36
13-14	10	4.96	2.52	2.92
14-15	1.25	0.62	2.52	4.82
15-16	11	5.45	2.52	1.89
16-17	11	5.45	2.52	-1.04
17-18	10	4.96	2.52	-3.48
18-21	0.75	0.37	7.56	3.71
21-24	0.75	0.37	7.56	10.9
0-24	100%	49.56	60.48	stock max = 13.88 stock min = -3.48

Overflow = flow over 24 h - daily demand      OF = 10.92 m<sup>3</sup>  
 Min volume of tank (economic) = max stock - min stock      V<sub>min</sub> = 17.34 m<sup>3</sup>  
 Volume of the tank to use all the spring (V<sub>min</sub> + OF)      V<sub>tank</sub> = 28.26 m<sup>3</sup>



**Fig 10.6: Representation of volume of water in a tank over one day.**

**Table 10.III: Calculation of water volume in tank.**

Period (h)	Coefficient of consumption (%)	Demand over the period (m <sup>3</sup> )	Production of the spring (m <sup>3</sup> )	Stock in the tank at end of period (m <sup>3</sup> )
0-6	2.5	1.24	15.12	17.34
6-7	10	4.96	2.52	14.90
7-8	10	4.96	2.52	12.47
8-9	11	5.45	2.52	9.53
9-10	10	4.96	2.52	7.10
10-11	10	4.96	2.52	4.66
11-13	1.75	0.87	5.04	8.83
13-14	10	4.96	2.52	6.40
14-15	1.25	0.62	2.52	8.30
15-16	11	5.45	2.52	5.37
16-17	11	5.45	2.52	2.44
17-18	10	4.96	2.52	0
18-21	0.75	0.37	7.56	7.19
21-24	0.75	0.37	7.56	14.38
0-24	100%	49.56	60.48	max = 17.34

As can be seen from Figure 10.6, the tank is refilled mainly from 18 h (there are also two brief refill periods during drops in consumption between 11-12h00 and 14-15h00 h). If the tank is designed for 17.5 m<sup>3</sup>, the overflow functions from 01h40 discharging a total volume of 10.92 m<sup>3</sup> over approximately 4 hours.

### 2.3 Tanks in pumped systems

In the case of a pumped supply, the volume of the tank is calculated according to the capacity of the pump and the frequency of pumping. In practice, it is considered that a volume corresponding to the daily water demand is satisfactory. This in effect means that the pump needs to be run only once per day.

For solar-powered pumping, the minimum capacity of the tank should be equal to the daily volume produced.

In emergency programmes, the tanks used are generally of fixed size: 10, 20, 30, 45, 70, and 95 m<sup>3</sup>, with the number of tanks determined by arrangements for water treatment (see Chapter 12).

### 2.4 Rainwater-catchment tanks

Rainwater-catchment tanks at the domestic or small collective level (school or health centre) are generally designed by comparing demand and cumulative monthly volumes over a year. For example, for a school in northern Uganda, with a roof area of 550 m<sup>2</sup>, the ratio of rainfall to water collected was estimated at 80% (corrugated iron roof - see Chapter 3), and rainfall data was available on a monthly basis. Daily demand was estimated at 1 000 l (100 pupils x 10 l/pupil/day). Figure 10.7 compares demand and volume of recoverable water, cumulated over a year. The volume of the tank can be defined graphically as the difference between the maximum monthly surplus and cumulative demand over this period, or 60 m<sup>3</sup> (month of October). As this volume is slightly greater than the maximum deficit for the month of March, estimated at 54 m<sup>3</sup>, demand should therefore be satisfied all year round.

In the absence of precise rainfall data, Pacey and Cullis (1986) suggest volumes shown in Table 10.IV.



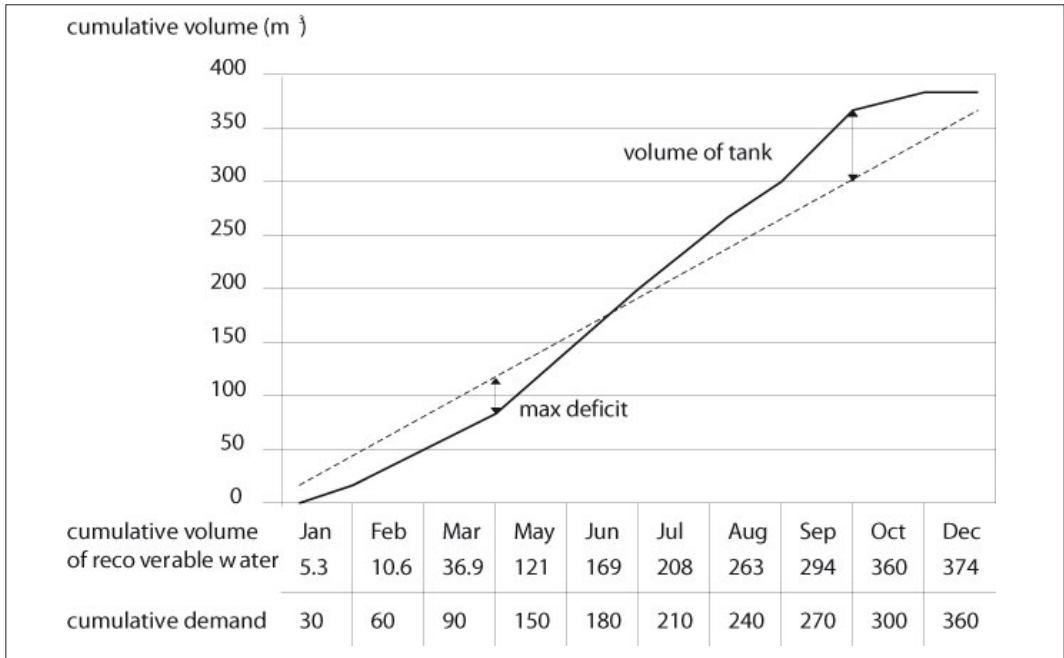


Figure 10.7: Design of a rainwater-catchment tank for a school (ACF, Uganda, 1996).

Table 10.IV: Volume of tank for domestic rainwater catchment.

Mean annual rainfall (mm)	Area of roof (m <sup>2</sup> )	Volume of tank (m <sup>3</sup> )	Volume of water available per day (l)	Reliability of the tank (% coverage over the year)
1 800 – no dry season (Jakarta)	30	3.6	30	99
800 – 2 rainy seasons (Ghana)	30	7.5	66	—
635 – 1 dry season of 6 months (Swaziland)	30	5	37	—
1 500 – 5 dry months (Indonesia)	30	5.1	30	99
1 300 – 4 dry months (Thailand)	30	5.8	45	95
1 200 – no dry season (Australia)	30	11.8	74	80
390 – no defined wet season (Australia)	30	10.5	25	80

## 2.5 Tanks for run-off catchment

On a collective scale, the volumes of tanks (*birkads* and ponds – see Chapter 3, Section 3, and Chapter 19) can be estimated from procedures used on the domestic scale. It is however preferable to work with 10-day rather than monthly data in order to optimise the design.

In the case of open storage (ponds), it is necessary to take account of losses due to evaporation and seepage.

Experience shows however that it is generally difficult to construct tanks large enough for storing large stream flows for collective consumption, because site conditions generally limit the footprint of tank possible.

## B FIELD EXAMPLE

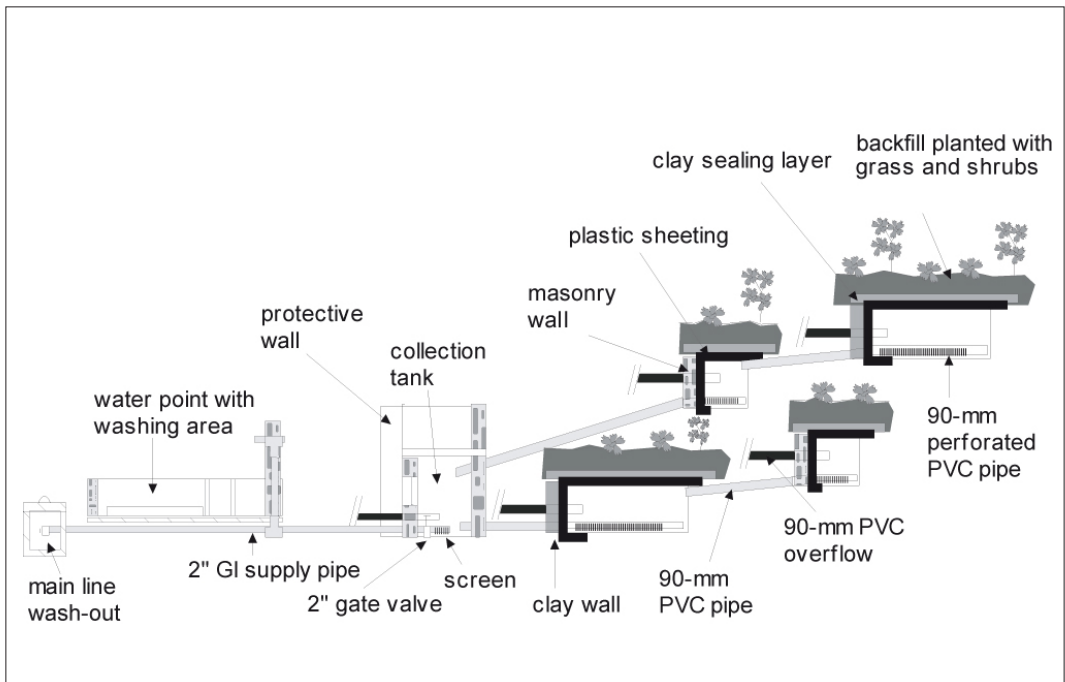
<b>1</b>	<b>Spring catchment</b>	372	2.4	Plumbing	378
<b>2</b>	<b>Water points</b>	374	2.5	Masonry	378
2.1	Earthworks	374	2.6	Constant-level channel	380
2.2	Foundations	375	2.7	Drainage channel	381
2.3	Reinforced-concrete slab	375			

This example shows the construction of a spring catchment and a water point with an adjoining washing area, carried out by ACF in Ethiopia. The water point is designed for continuous distribution of water (without a tap), installed at the end of a water supply line (20 to 200 m). The adjoining laundry area, in the form of a low slab, is supplied by an open channel.

### 1 Spring catchment

The spring catchment is shown in Figure 10.8. It is fed by four infiltration galleries from four springs, a maximum of 20 metres away. Water from all four springs is required because of their low flow.

The materials used in the Ababuo spring are shown in Table 10.V.



**Figure 10.8: Spring catchment.**

**Table 10.V: Materials and cost of a spring catchment.**

Site: Ababuo Number of beneficiaries: 605 (123 families)  
 Kebele: Sundusa  
 Woreda: Soro Starting date: 16/11/92  
 Area: Hadya Hand-over to beneficiaries: 17/08/93

MATERIALS AND EQUIPMENT	Quantity	Unit cost (US\$)	Total (US\$)	
<b>Building materials</b>				
cement (50 kg)	37	15	74.00	
sand (100 kg)	110	5	73.33	
stone (m <sup>3</sup> )	35	10	46.67	
8-mm reinforcement (12-m bars)	30	30	120.00	
6-mm reinforcement (kg)	7.5	20	20.00	
binding wire (kg)	5	10	6.67	
barbed wire (m)	200	0.9	24.00	
wood for fence	1	300	40.00	
nails	8	12	12.80	
metal door	1	175	23.33	
<b>Plumbing materials</b>				
<b>2" GI</b>				
tee	2	35	9.33	
socket	5	25	16.67	
2" / 1"1/2 reducer	2	25	6.67	
plug	1	20	2.67	
union	1	50	6.67	
gate valve	1	90	12.00	
pipe (6 m)	5	200	133.33	
<b>1" 1/2 GI</b>				
tee	1	30	4.00	
elbow	1	20	2.67	
pipe (1.40 m)	1	35	4.67	
<b>PVC</b>				
90 mm pipe (6 m)	49	100	653.33	
50 mm pipe (6 m)	3	24	9.60	
<b>TOTAL 1</b>			<b>1 302.40</b>	
<b>LABOUR</b>				
	Number	Working days	Cost/day (US\$)	Total (US\$)
Foreman	1	28	21	78.40
Mason	2	54	18	259.20
Assistant mason	4	54	12	345.60
Project assistant	1	52	19	131.73
Mechanic	1	28	18	67.20
Driver	1	54	16	115.20
Stonemason	1	43	12.5	71.67
Labourers	4	32	6	102.40
<b>TOTAL 2</b>				<b>1 171.40</b>
<b>LOGISTICS</b>				
Transport				533.48
Storage				128.07
<b>TOTAL 3</b>				<b>661.55</b>
<b>ADMINISTRATIVE COSTS</b>				
<b>TOTAL 4</b>				<b>275.40</b>
<b>GENERAL TOTAL</b>				
				<b>3 410.75</b>
Cost per beneficiary				<b>5.64</b>

## 2 Water points

The following technical description lists the stages of construction:

- earthworks,
- foundations,
- concrete reinforcement,
- slab,
- plumbing,
- masonry,
- constant-level channel,
- drainage channel.

The materials used and the time required for constructing the water point are shown in Table 10.VI (water point with one outlet, water supply in 1”1/4 GI, drainage channel 5 m long).

**Table 10.VI : Resources necessary for the construction of a water point.**

Activity	Labour (man/day)	Stone (m <sup>3</sup> )	Sand (m <sup>3</sup> )	Gravel (m <sup>3</sup> )	Cement (50 kg)	6-mm bars (kg)	8-mm bars (12 m)	Plumbing fittings
Excavation	4 labourers							
Foundations	1.5 masons 4.5 assistant masons	4.1						
Reinforcement	2 masons 6 assistant masons					15	9 bars + 2 kg binding wire	
Slab	2 masons 6 assistant masons		0.625	1.25	10			
Plumbing	1 plumber 1 labourer							union (1); tee(2) socket (2); nipple (1); elbow (1); plug (2); GI pipe (1.25 m)
Masonry	2 masons 6 assistant masons	0.65	0.35		3			
Constant-level channel	0.006 mason 0.018 assistant mason	0.002	0.001		0.25 l			75 mm PVC pipe or GI 2”1/2 (0.10 m)
Dainage channel + toe	3 masons 9 assistant masons	0.795	0.225	0.24	2.8	13 + 0.5 kg binding wire		
TOTAL (rounded)	11 masons 33 assistant masons 1 plumber 5 labourers	5.6	1.3	1.5	16	28 + 2.5 kg binding wire	9 bars	

### 2.1 Earthworks

Earthworks include all the various tasks involved in preparing the ground for the water point and washing area. The choice of location of the spring is first of all linked to the slope: a minimum slope of 3% is necessary for the supply line, and 1% for the water point channels and drainage channel. Therefore, it is necessary to choose the location which best meets these conditions, while minimising the length of the transmission line from the spring, to limit costs.

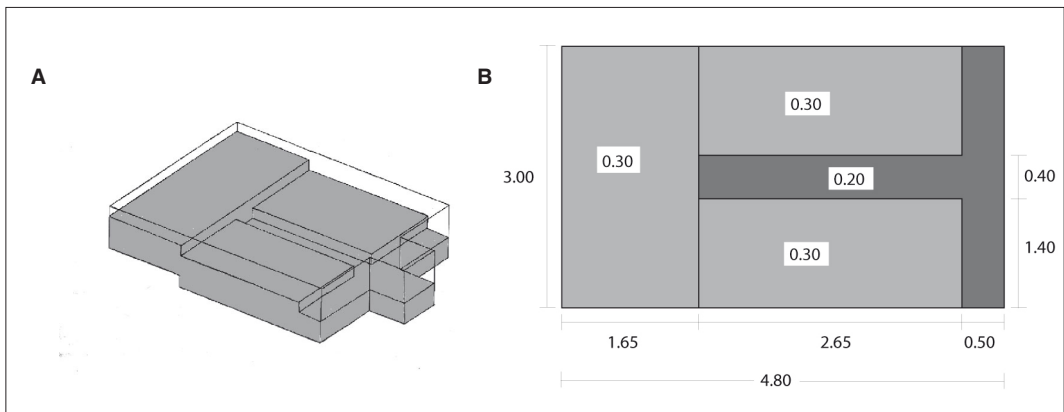
The water point (Table 10.VII) is marked out with wooden stakes or similar materials and cord (4-mm diameter nylon). Right angles must be checked with a square.

**Table 10.VII: Quantities of excavation for the siting of a water point.**

Area required	3.00 m x 4.80 m = 14.4 m <sup>2</sup>	
Depth of foundations	0 → 1.65 m	Depth = 0.40 m
	1.65 → 4.80 m	Depth = 0.45 m
Excavated volume	6.25 m <sup>3</sup>	
Labour	4 man/days	

## 2.2 Foundations

The depth of the foundations is variable, and depends on the nature of the ground. The depths used in ACF constructions are quite large, and can be used in relatively unconsolidated ground (Figure 10.92 & Table 10.VIII).



**Figure 10.9: Foundations of tapstand and laundry area.**  
**A: perspective view. B: plan.**

**Table 10.VIII: Quantities of foundation works for a tapstand.**

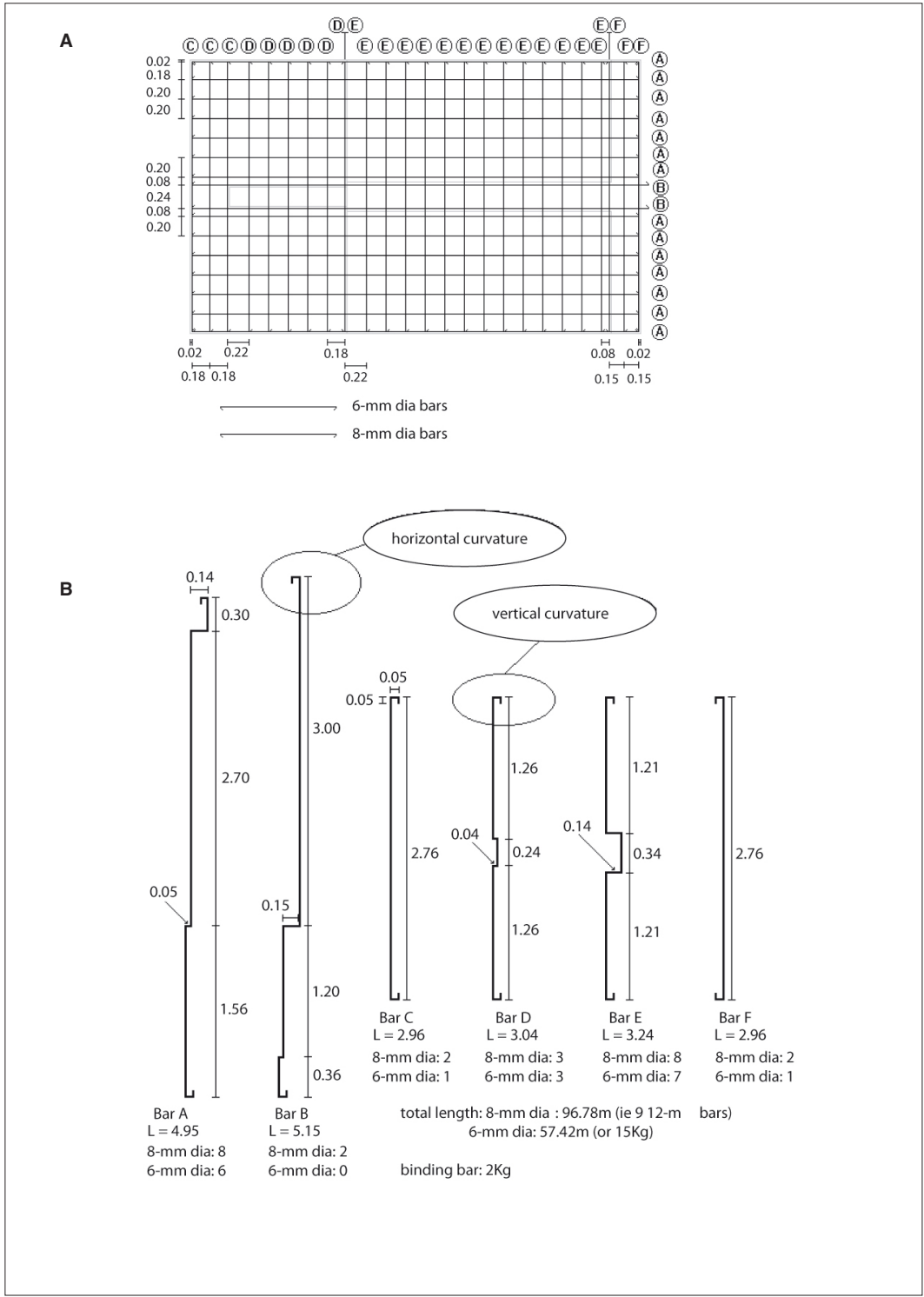
These foundations extend 0.10 m beyond the slab to provide sufficient bearing.

Thickness of coarse stone	0 → 1.65 m	Depth = 0.30 m
	1.65 → 4.80 m	Depth = 0.20 to 0.30 m
Total volume of stone	4.1 m <sup>3</sup>	
Labour	1.5 mason/days	
	4.5 assistant mason/days	

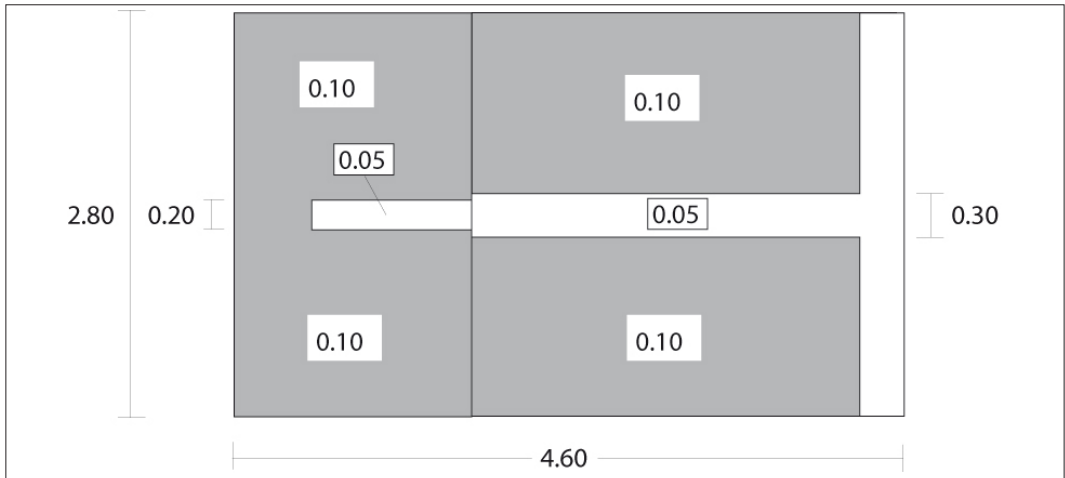
## 2.3 Reinforced-concrete slab

The slab is made of reinforced concrete. The first part of the work is to prepare and place the reinforcement which will be embedded in the concrete (Figure 10.10). The second operation is pouring the slab.

The concrete is reinforced with 8-mm (twisted) and 6-mm (smooth) reinforcement bars, alternated, in a 0.20-m mesh (Figure 10.10). The bars are curved at the ends to provide better anchorage in the concrete.



**Figure 10.10: Slab reinforcement plan.**  
**A: general plan. B: diameters of the different bars**



**Figure 10.11: Plan of the slab.**

If several water points of this type are to be constructed, a template may be made in order to facilitate the preparation of the reinforcement.

Special care must be taken with the placing the reinforcement, because its effectiveness in ensuring the strength of the foundation depends critically on this stage. In particular, the distance between the bars, and the depth at which the reinforcement is placed in the foundations, must be precisely maintained.

To keep the bars in the correct position, annealed steel wire is used for binding, plus gravel or small pebbles which are embedded in the concrete at the time of pouring. The curved end of the bars is 0.02 m from the external edge of the slab.

The foundation for the water point and washing area is constructed as a single piece, in order to provide sufficient strength over the whole area. If it is difficult to pour the slab in one operation, particularly because of the different levels of shuttering on the slope, the work may be completed over two days, taking care to leave keyed surfaces (rough, clean and well wetted) at the end of the first day.

The slab for the water point, the passage area and the washing areas is 0.10 m thick. The thickness of the concrete for the channels is 0.05 m (Figures 10.11 & 10.12).

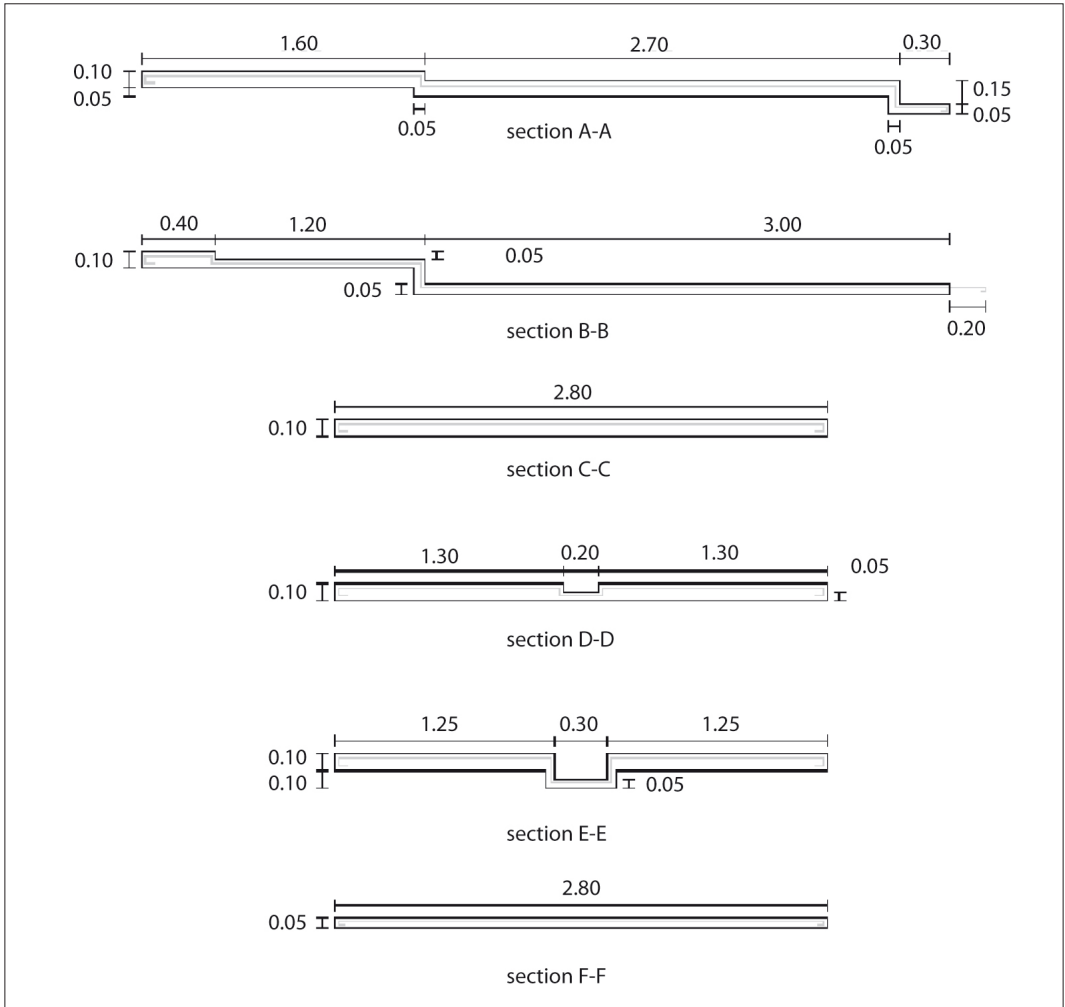
Special care must be taken in the preparation of the concrete, which must have a 'plastic' texture, to be able to flow between the reinforcement bars completely.

When pouring the concrete, it is necessary to ensure that the aggregates do not prevent it from settling under the reinforcement (vibrate the concrete), and also that the reinforcement itself stays in place.

Quantities for the concrete are given in Table 10.IX.

**Table 10.IX: Characteristics of concrete at 350 kg cement / m<sup>3</sup> used for the slab.**

Proportions	1 volume of cement 2 volumes of sand 4 volumes of gravel
Total volume of concrete	1.25 m <sup>3</sup>
cement	10 bags of 50 kg
sand	0.625 m <sup>3</sup>
gravel	1.25 m <sup>3</sup>
Labour	2 mason/days 6 assistant mason/days



**Figure 10.12: Sections of the slab.**

## 2.4 Plumbing

For the water point, GI pipes are inserted into the masonry (PVC does not adhere well to mortar or concrete). Plugs are installed on pipes as shown in Figure 10.13:

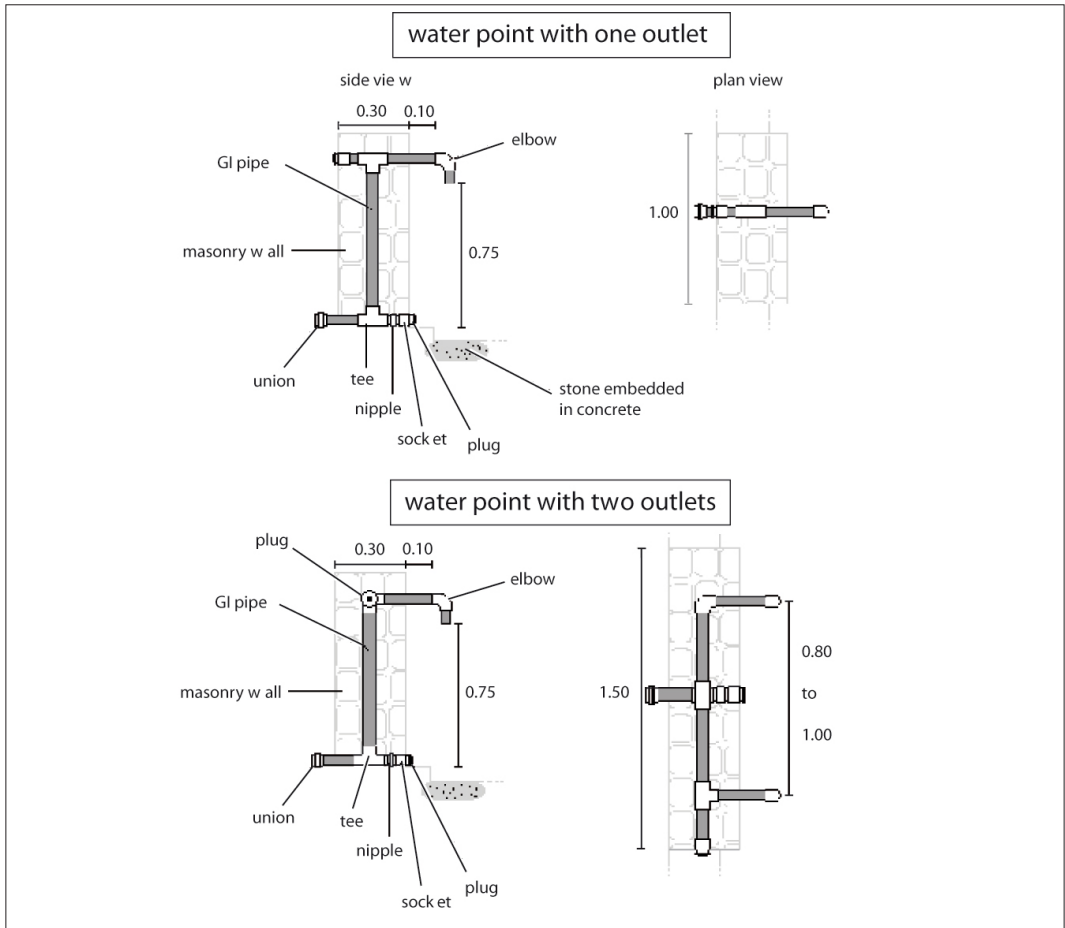
- one at the bottom of the water point, allowing the supply system to be drained;
- the other opposite the outlet(s), so as to be able to clean any blockage without having to dismantle the water point.

The diameter used is determined by the flow of the spring. In the case of springs with variable flow, a compromise must be found between dry season and wet season flows to choose the diameter of the supply pipe.

## 2.5 Masonry

The water-point wall, the exterior protection walls and the low interior separation walls are made in masonry. The foundation serves as a base for the construction. The following wall dimensions are chosen:





**Figure 10.13: Plumbing for water point.**

- for the exterior walls, a thickness of 0.20 m and a height above ground level of 0.20 m;
- for the interior walls, a thickness of 0.10 m with a height of 0.10 m for the water-collection area/passage area separation, and 0.15 m for the passage area/washing area separation.

The dimensions of the water-point wall are variable, depending on the number of outlets installed: here a diameter of 0.30 m and a height of 1.00 m have been used, with the outlet at 0.75 m from the ground (Figure 10.14 & Table 10.X).

**Table 10.X: Materials for the construction of the water-point walls.**

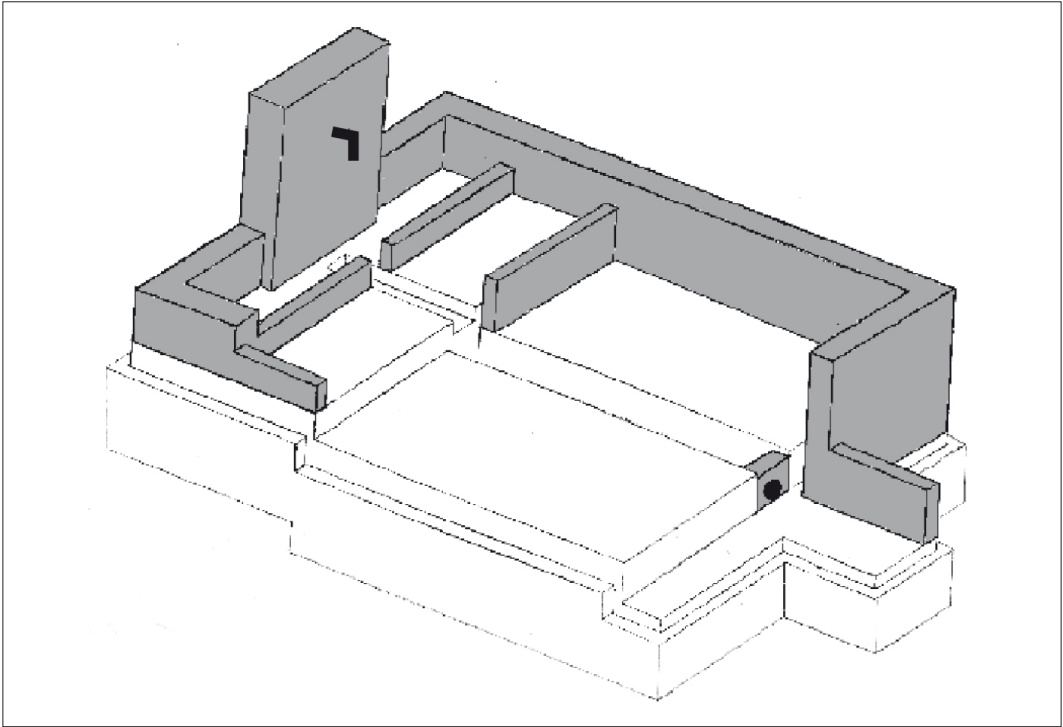
**For these calculations, the dimensions of the water-point wall are 1.00 x 1.00 x 0.30 for a single outlet.**

Volumes required

stone	0.65 m <sup>3</sup>
mortar	0.35 m <sup>3</sup>
sand:	0.35 m <sup>3</sup>
cement:	3 bags of 50 kg each

Labour

2 mason/days
6 assistant mason/days



**Figure 10.14: Water-point walls.**

## 2.6 Constant-level channel

The aims are to have a permanent reserve of water always available for washing, and to limit water transport. If the drainage outlet is blocked (with a cloth, for example), the level of the water in the channel rises, until it overflows the sill at the end of the channel: by removing the 'plug' the water is drained normally and the channel can be cleaned.

The system consists of setting a pipe 0.10 m in length (75 mm PVC or 2"1/2 GI), in the masonry sill (0.10 x 0.10 x 0.30 m) at the end of the channel, to make a dam that can be plugged (Table 10.XI). The volume in the channel when full is 78 l.

**Table 10.XI: Quantities for the construction of the channel.**

Volumes needed	
stone	0.002 m <sup>3</sup>
mortar	0.001 m <sup>3</sup>
	– sand: 0.001 m <sup>3</sup>
	– cement: 0.25 l
Pipe (75 mm PVC or 2" 1/2 GI)	0.10 m
Labour	0.006 masons/day 0.018 assistant mason/day

## 2.7 Drainage channel

This channel allows the drainage of water from the water point to a suitable location. It must have a minimum slope of 1% to ensure good flow and facilitate drainage.

The channel can be built of brickwork on a reinforced-concrete foundation, or of reinforced concrete alone. Its length is determined essentially by the slope, and the outlet should be at ground level to avoid any subsequent bogging.

It is essential to construct a toe at its end, to stop the channel being undercut by the drainage water, as well as to lay stone around the channel outlet to provide a free-draining surface (Figure 10.15).

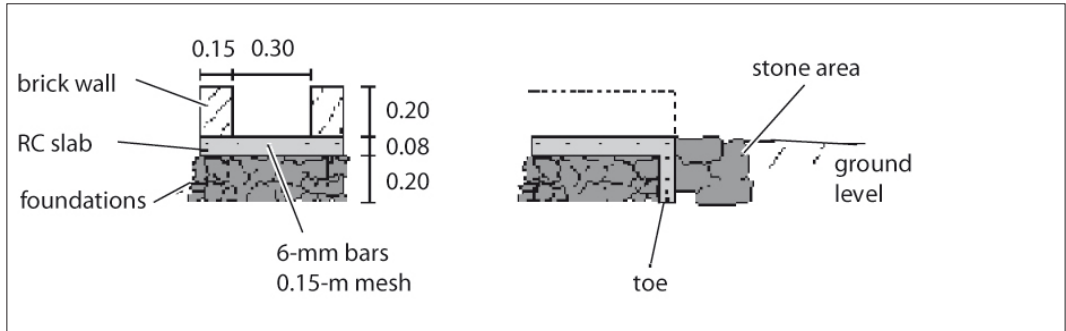


Figure 10.15: Drainage channel (A) and toe (B).



# Gravity distribution systems

## A SYSTEM DESIGN AND CONSTRUCTION

<b>1</b>	<b>Feasibility study</b>	384			
1.1	Drawing up the distribution plan	384	<b>3</b>	<b>Construction of the system</b>	402
1.2	Rapid topographic survey	387	3.1	Header tanks and break-pressure tanks	402
1.3	Technical verification	387	3.2	Storage tank	404
<b>2</b>	<b>Detailed survey</b>	388	3.3	Pipes	404
2.1	Topographic survey	388	3.3.1	<i>Pipes and components</i>	404
2.1.1	<i>Choice of pipe route</i>	388	3.3.1.1	Equivalent diameters	404
2.1.2	<i>Topographic survey methodology</i>	388	3.3.1.2	Pressure classes	405
2.1.3	<i>Drawing up the topographic profile</i>	389	3.3.1.3	Valves and taps	405
2.2	Hydraulic design	390	3.3.1.4	GI pipes and fittings	406
2.2.1	<i>Energy profiles</i>	390	3.3.1.5	PVC pipes and fittings	407
2.2.1.1	Static profile	390	3.3.1.6	Polyethylene pipes and fittings	409
2.2.1.2	Class of pipe pressure and header tanks	390	3.3.1.7	Quick-fit connections	410
2.2.1.3	Dynamic profile	392	3.3.1.8	Standard tools	411
2.2.2	<i>Calculation of head losses</i>	393	3.3.1.9	Accessories for repair and connection of cast-iron pipe	412
2.2.2.1	Linear head losses	393	3.3.1.10	Equipment for pipe repair	412
2.2.2.2	Secondary head losses	395	3.3.1.11	Equipment for pipes under pressure	413
2.3	System design	395	3.3.2	<i>Installing pipes</i>	414
2.3.1	<i>Design of the storage tank</i>	395	3.3.2.1	Trench	414
2.3.2	<i>Location of structures</i>	396	3.3.2.2	Pipe laying	414
2.3.2.1	Header tank	396	3.3.2.3	Backfilling	414
2.3.2.2	Storage tank	397	3.3.2.4	Passage above ground	414
2.3.2.3	Break-pressure tank	397	3.3.2.5	Crossing under a road	416
2.3.3	<i>Choice of types, diameters and lengths of pipe</i>	397	3.3.2.6	Thrust blocks	416
2.3.3.1	Types of pipe	397	3.3.2.7	Anchors	416
2.3.3.2	Pipe diameters	398	3.3.2.8	Location markers	416
2.3.3.3	Gravity transmission (spring-to-tank-line)	398	3.3.2.9	Drain valves	417
2.3.3.4	Gravity distribution (tank-to-tapstand lines)	399	3.3.2.10	Air vents	417
2.3.4	<i>System valve plan</i>	401	3.3.2.11	Valve chambers	417
2.3.4.1	Regulating valves	401	3.4	Tapstands	417
			3.4.1	<i>Fittings</i>	417
			3.4.2	<i>Construction</i>	417

The need for water can be expressed in terms of quantity and quality, but also in terms of accessibility. There are many examples of water points that are under-used because they are too remote from dwellings, or because consumption is restricted because of the long and arduous journey to collect water. It is therefore essential that populations have easy access to water points.

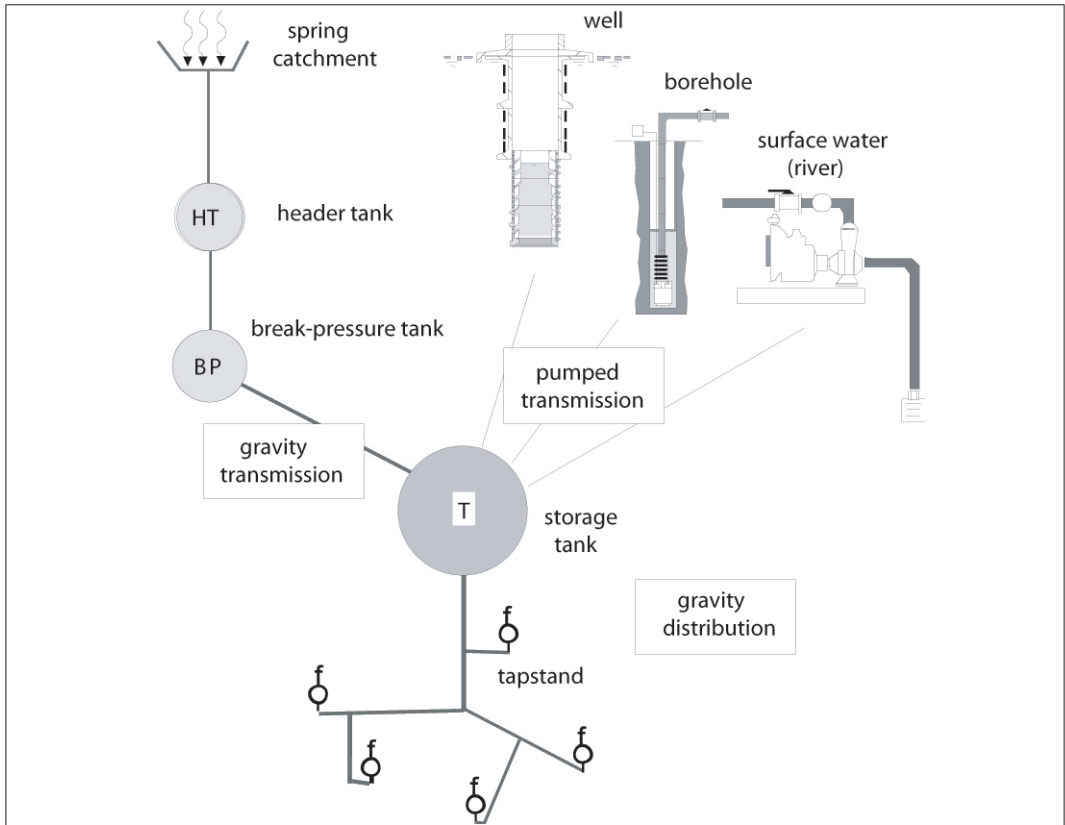


Figure 11.1: Distribution system: various possible schemes.

This chapter presents techniques used by ACF for the design and construction of gravity systems for the transmission and distribution of water (Figure 11.1). Transmission of water by pumping is covered in Chapter 9.

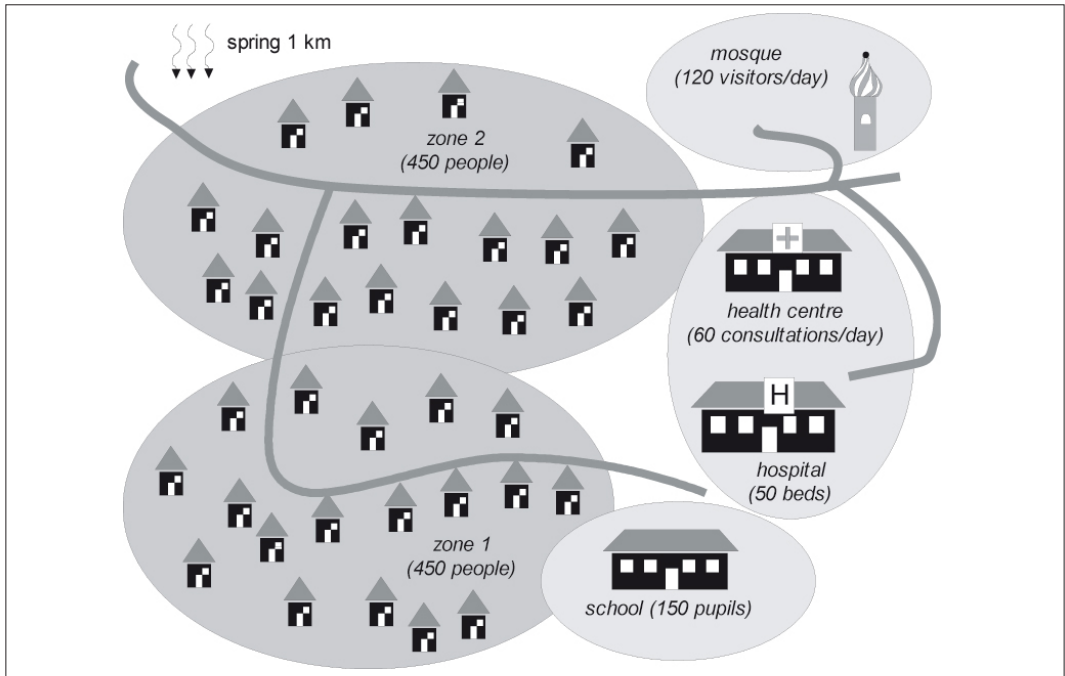
The example of a branched system in the village of Aloua, fed by a spring catchment, illustrates stages of this work, and an example of system design in Laos is given Chapter 11B.

## 1 Feasibility study

The design of a gravity system is a relatively long piece of work that is difficult to do during a project identification mission. A feasibility study therefore attempts to define the main technical and budgetary aspects of the project. If the findings of this survey indicate that the project is feasible, a more complete survey is undertaken.

### 1.1 Drawing up the distribution plan

Needs are identified during an assessment visit (see Chapter 2). From this investigation, a layout plan of the site is created, on which the recorded needs and distribution zones are marked. These zones are defined according to social criteria (origins of populations, differences between districts, presence of health structures, religious factors etc.) and technical criteria (accessibility, topography etc.). An example is given in Figure 11.2.



**Figure 11.2: Layout plan delimiting distribution zones: Aloua village.**

The water needs of the community are identified for every zone. They are expressed as daily volume, then as average flow for the chosen distribution period: for example, in a district of 450 inhabitants whose needs are 20 litres per person per day, the daily volume required is:  $450 \times 20 = 9\,000$  l. If daily consumption is considered to be spread over 10 hours, the supply flow for the zone must be  $9\,000/10 = 900$  l/h. This is known as the useful flow. Precise definition of the system's period of use during the day is necessary because it has a marked effect on useful flow. In the previous example, if the chosen supply period is 5 h instead of 10, the useful flow is doubled (1 800 l/h).

Broadly speaking, if it is assumed that the system is used continuously for 10 hours a day, consumption peaks, and therefore the useful flow, tend to level out. Depending on the cultural context, it is possible to reduce this period of use to 8 or 6 hours or, better, to estimate demand per hour. It is essentially the habits and daily rhythm of the population that accurately defines the useful flow required.

For public distribution via tapstands, the number of taps is given by the useful flow and access to water points, from the figures shown in Table 11.I.

In the previous example, the useful flow of 900 l/h (or 0.25 l/s) can be distributed by  $0.25/0.2 = 1.25$ , or two Talbot type taps. With a population of 450, it is preferable to install  $450/150 = 3$  taps to limit waiting time at the water point. The three taps are installed on one or more tapstands depending on the area of the zone (maximum distance between two tapstands is 250 m).

**Table 11.I: Working criteria for tapstands.**

Flow of a standard 3/4" tap (under 10 m of pressure)	0.2 to 0.3 l/s
Flow of a Talbot tap (under 5 m of pressure)	0.1 to 0.2 l/s
Maximum number of people per tap	150 people
Maximum distance between 2 tapstands	250 m

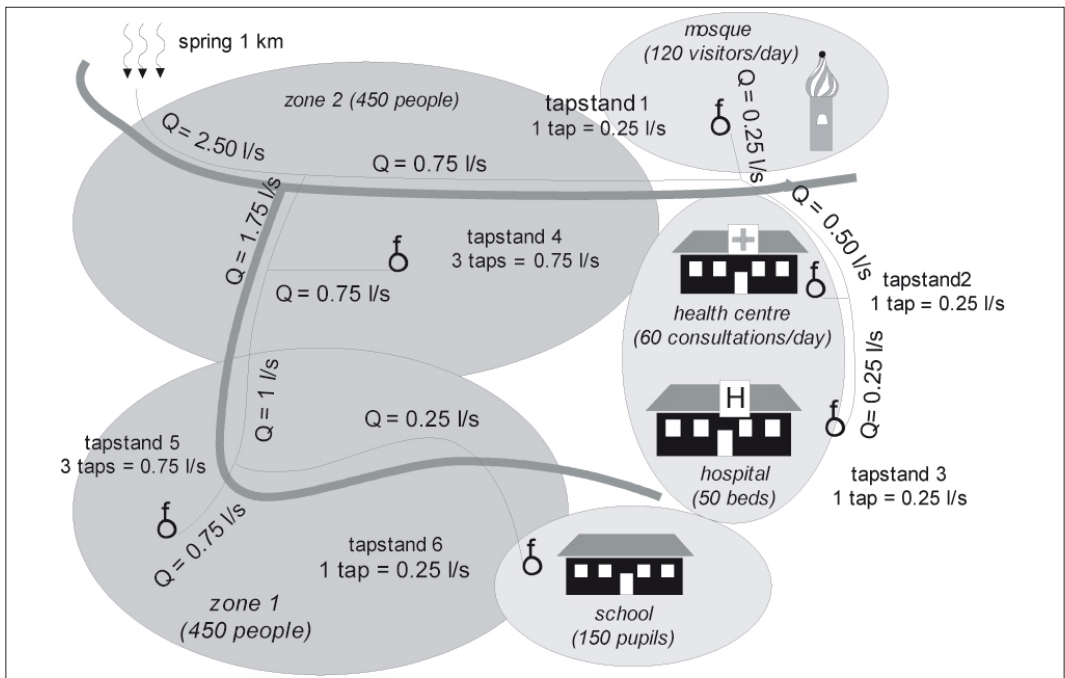
**Table 11.11: Calculation of needs for Aloua village. January 1995, annual growth rate: 2%.**

	Number	Number 10 years	Unit needs (l/pers/day)	Total needs (m <sup>3</sup> /day)	Number of taps at 0.25 l/s
Health centre	50 consultations	60	20	1.2	1
Hospital	40 beds	48	50	2.4	1
School	150 pupils	180	10	1.8	1
Religious centre	100 visitors	120	10	1.2	1
Inhabitants	900 inhabitants	1 080	40	43.2	6
Total needs, water (m <sup>3</sup> /day):	49.8				
Need in tapstands, 1 tap:	4				
Need in tapstands, 2 taps:	0				
Need in tapstands, 3 taps:	2				

The design of the system must be aimed at a minimum life of 10 years. It is necessary to take account the normal population growth rate, plus the possibility of additional population growth due, for example, to the arrival of water or a road (Table 11.11).

When the number of tapstands and taps has been determined, information on maximum flows in each distribution branch (maximum flow = number of taps served x unit flow of taps, see Figure 11.3) is marked on the outline layout. In the Aloua example, a unit flow of 0.25 l/s per tap was chosen. The layout plan completed in this way is an essential tool for determining diameters and lengths of pipe, used in parallel with topographic profiles. Symbols used are shown in Figure 11.11.

The maximum instantaneous flows calculated in this way ensure the distribution of a daily volume greater than needed (number of taps rounded up in every zone). In the example of Aloua, daily



**Figure 11.3: Marking out lines, flows and numbers of taps.**



needs were estimated at 49.8 m<sup>3</sup>, whereas the sum of the maximum flows is (0.75 x 2) + (0.25 x 4) = 2.5 l/s, or 9 000 l/h over a six-hour period, or 54 m<sup>3</sup>/day. In practice, the flow passing through the system does not correspond to the maximum flow at certain hours in the day, when all taps will be open. The rest of the time, flow will be lower and the daily volume distributed will be closer to that calculated on the basis of need.

## 1.2 Rapid topographic survey

The objective is to determine whether the difference in level between the various points in the system is sufficient to permit flow of water by gravity.

A rapid estimate can be made simply by using an altimeter. A reading of the altitude of the characteristic points on the line of the pipe is carried out, covering high and low points, areas served etc. Distance at ground level is measured in number of paces.

Since the altimeter is directly linked to atmospheric pressure, altitude measurements must be made at fixed points (fixed altitude) to compare with the altitude measured by the operator as they move from point to point.

A rapid summary card is shown in Table 11.III.

**Table 11.III: Altimeter summary card.**

Grid for the mobile operator on the pipe route					Grid for the stationary assistant		
Hour / minute	Distance over ground (m)	Distance (cumulative) (m)	Altitude (m)	Comments		Hour / minute	Altitude (m)

## 1.3 Technical verification

Two conditions must be met in order to verify the feasibility of the system: the available water quantity at the source must be sufficient to cover needs, and the topography must permit gravity distribution. When needs are defined for every zone, it is simple to verify the feasibility of the system in terms of quantity: water flow over 24 hours must be greater than, or equal to, the daily needs of the community.

To permit gravity distribution, the slope between the highest point of the system (reservoir or spring catchment) and the furthest point in the system must be greater than 1%. If a 1% slope line is drawn from the highest point, no part of the system must be situated above it.

If these two conditions are met, it is basically technically possible to construct a gravity distribution system that will cover the needs of the population. However, this must then be confirmed by a detailed survey.

## 2 Detailed survey

### 2.1 Topographic survey

The topographic survey is an essential part of the design method for gravity systems. This survey of differences in level enables energy balances to be drawn up, and flows, velocities and head-losses to be calculated for all points in the system.

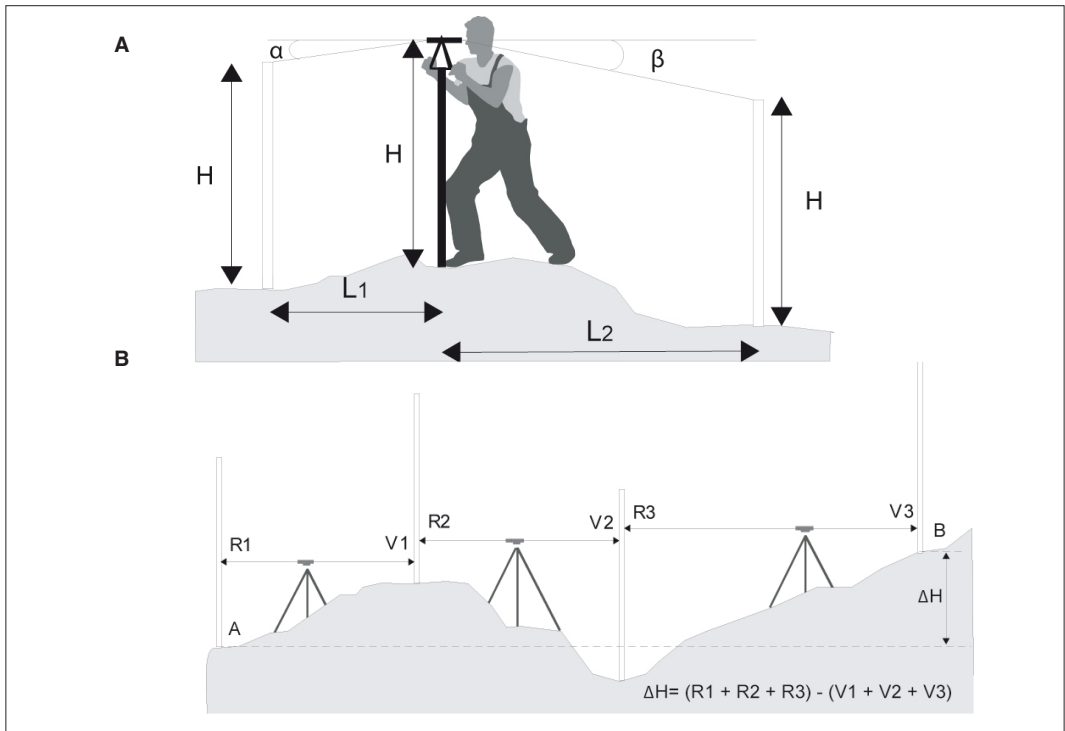
#### 2.1.1 CHOICE OF PIPE ROUTE

It is possible to establish a theoretical pipe route to avoid difficult passages using a map or aerial photograph, but the definitive route can only be established by visiting the area along with someone who knows the locality well. In defining the route, the following problems need to be taken into account:

- minimising the number of difficult crossings: roads, gullies etc.;
- avoiding steep slopes: difficulty of pipe anchorage;
- avoiding rocky zones: difficulty of trench digging;
- looking for accessible zones: alongside existing paths, for example;
- considering problems of land ownership and authorisation;
- being aware of community problems such as constraints linked to the occupation of land (gardens, houses etc.).

#### 2.1.2 TOPOGRAPHIC SURVEY METHODOLOGY

The rapid survey made during the preliminary assessment must be confirmed and detailed by an accurate survey. The easiest on-site technique consists of using a level. The use of a theodolite is



**Figure 11.4: Topographic survey.**

**A: with Abney level or clinometer. B: with dumpy level.**

recommended, because the measurement precision is very good. However, an Abney level or a clinometer may be used in relatively inaccessible regions.

The principle of the Abney level and the clinometer involves measuring the angle between a given point and the horizontal. If the distance on the ground between this point and the measuring device is known, it is easy to calculate the difference in level (from the distance on the ground multiplied by the sine of the angle in degrees).

Two readings per point are taken, one reading forward, and one reading back to the previous point to confirm the measurement. The distance on the ground is measured using a tape measure.

The Abney level or clinometer (Figure 11.4A) must be placed on a rule to assure stability. Readings are taken at the top of wooden rules held by assistants. The three rules must be exactly the same length.

The theodolite (Figure 11.4B) can achieve very high accuracy and can also measure horizontal distances with the rangefinder of the telescope. These distances correspond to the horizontal distance between two points, and not to the distance on the ground (the one that is useful to know because it represents the length of pipe needed). The distance on the ground is measured with a tape measure, or calculated from the angle of sight and the horizontal distance read on the telescope.

The reading is made by sighting rules held vertically by assistants.

### 2.1.3 DRAWING UP THE TOPOGRAPHIC PROFILE

The topographic summaries are represented as a profile that illustrates the energy balances of the water in the pipes. It is also useful to make every profile correspond to a plan to illustrate important points and junctions with other pipelines (Figure 11.5).

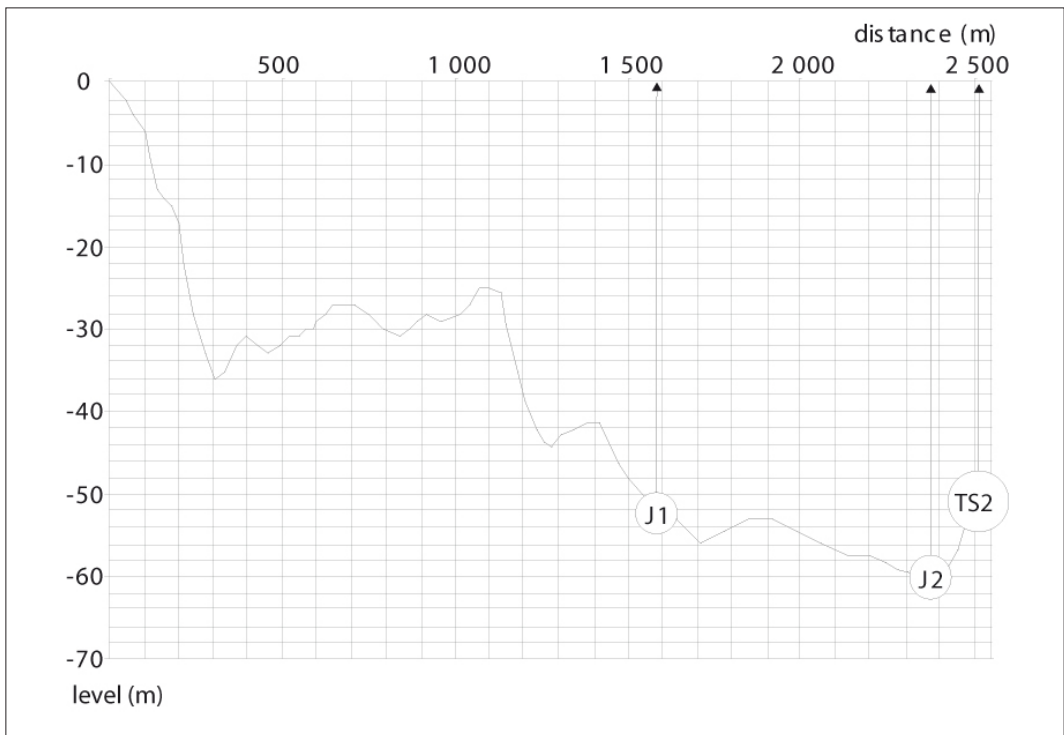


Figure 11.5A: Topographic profile (from catchment/J1/J2/Ts2, Aloua).

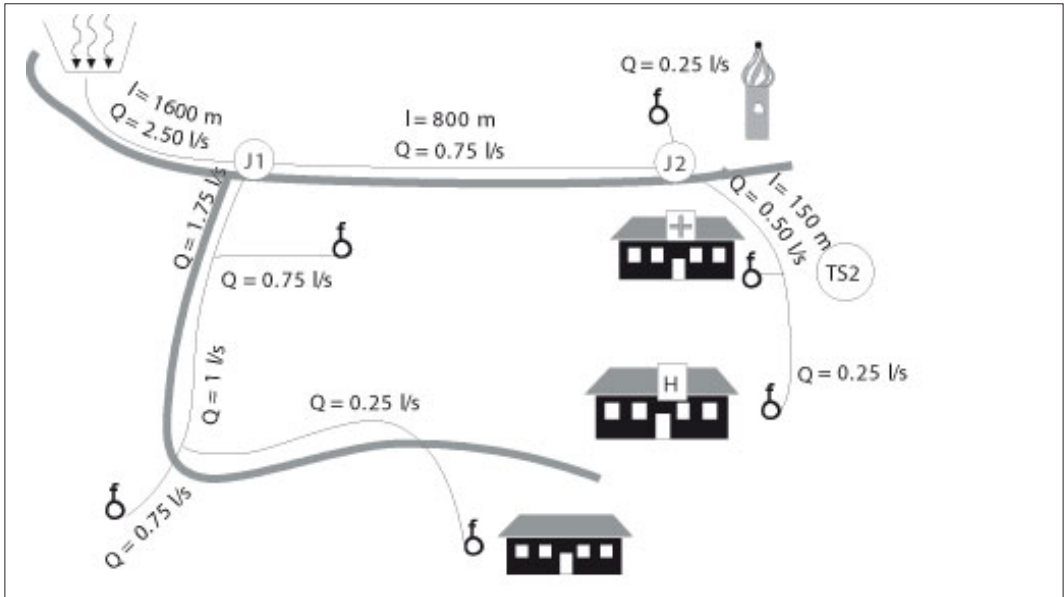


Figure 11.5B: Layout plan (from catchment/J1/J2/Ts2, Aloua).

## 2.2 Hydraulic design

### 2.2.1 ENERGY PROFILES

#### 2.2.1.1 Static profile

The static-head profile represents the water energy at zero flow (closed taps).

The pressure in a closed pipe under load ( $Q = 0$ ) can be regarded as being equal to the weight of the water column between its upper point and the point under consideration (see Annex 6). This pressure, known as the static pressure, is the driving force of the system: in other words, it is difference in level between the various points of the system that causes the flow of water from the tank (or the spring catchment) to the tapstands.

The static pressure is expressed in mWG (metres water gauge), so that:

$$P_{\text{static}} \text{ (mWG)} = H(\text{m})$$

where  $H$  is the difference in level between the upper point and the point under consideration. In Figure 11.6, the high point is the free water surface of the tank.

In simple systems, the static pressure is the maximum pressure that can exist inside the pipes. It therefore determines the pressure the pipes must be able to resist, and whether it will be necessary to use pressure-limiting devices.

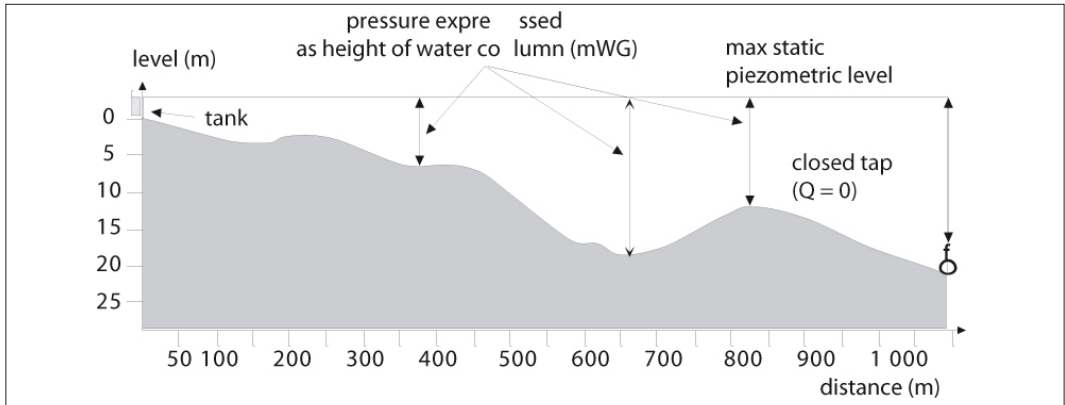
#### 2.2.1.2 Class of pipe pressure and header tanks

The pipes used will withstand a given pressure, known as the nominal pressure (NP): if the pressure in the pipe is greater than this, there is a risk of rupture. The NP is generally expressed in bars. The usual pressure classes are given in Table 11.IV.

From the static-head profile it is possible to define the pipe class needed. In Figure 11.7, the static level at the lowest point is 75 mWG, or 7.5 bar. A pipe of 6 bars nominal pressure (NP 6) would therefore be inadequate, so it is necessary to use NP 10 bar pipe.

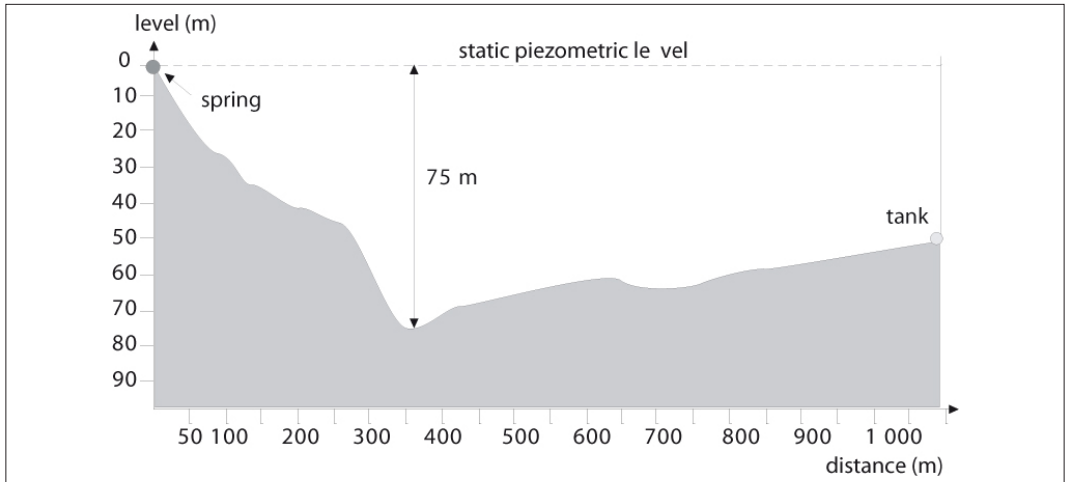
**Table 11.IV: Classes of pressure of distribution pipes.**

PE (polyethylene)	PVC (polyvinyl chloride)	GI (galvanised steel)
NP 6 NP 10 NP 12.5	NP 6 NP 10	NP 16 NP 25



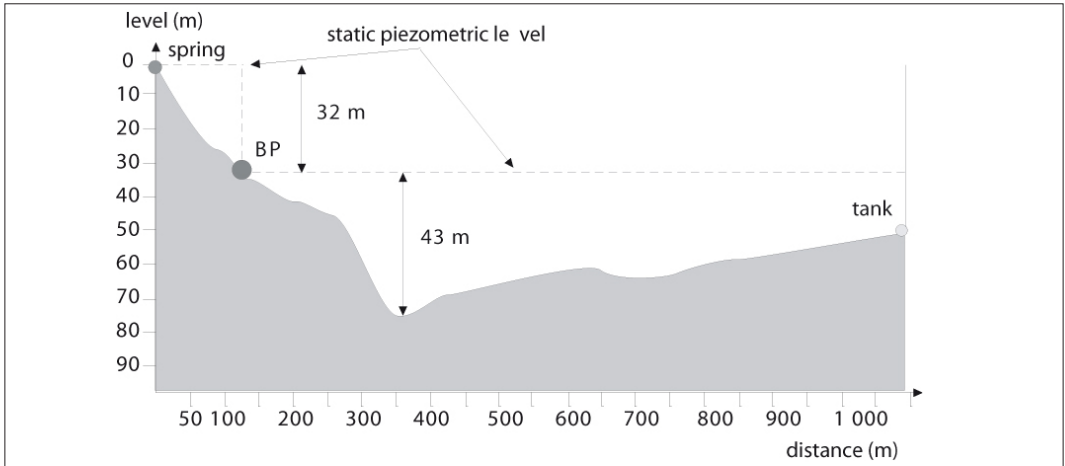
**Figure 11.6: Static pressure in a pipe system.**

If the pressure imposed by the topography is too great for the class of pipe available, it is possible to construct a break-pressure tank that returns the pressure in the system to atmospheric. Whenever there is a free surface in contact with the atmosphere, the static pressure becomes zero, because the pressure on this surface is equal to the air pressure\*.



**Figure 11.7: Static profile and pressure class of pipes.**

\* Here we are using relative pressure, i.e. related to the atmospheric pressure that acts on the whole system. Zero pressure means therefore that the actual pressure is  $P_{\text{atmospheric}}$ .



**Figure 11.8: Installation of a break-pressure tank to stay within a pipe class ( $P_{\text{static}} < 60$  mWG).**

In a distribution system, the free surfaces are reservoirs, header tanks, break-pressure tanks, and catchment tanks. In the example in Figure 11.7, the pipe class had to be NP 10. However, if there were only NP 6-class pipes available, it would be possible to install a break-pressure tank to control the pressure. Figure 11.8 shows the installation of a break-pressure tank to obtain maximum static pressures of 32 mWG upstream and 43 mWG downstream.

### 2.2.1.3 Dynamic profile

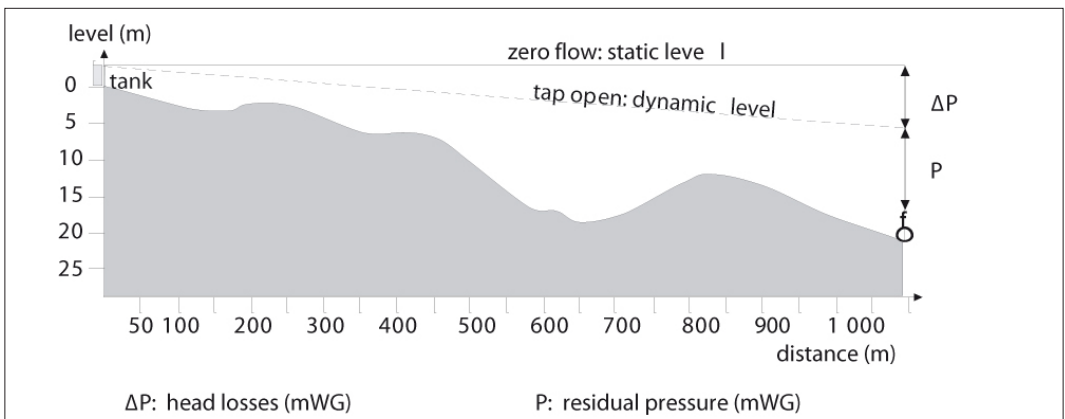
When water moves in pipes, pressure losses due to water friction occur. These pressure losses are referred to as ‘head-losses’ (see Annex 12).

If the pressure-drop line during flow is drawn, the dynamic-head profile is obtained (Figure 11.9).

Part of the total pressure is therefore taken up in head-losses ( $\Delta P$ ) during the transmission of water. The residual pressure is then defined by:

$$P_{\text{residual}} = H - \Delta P$$

where  $P_{\text{residual}}$  is the residual pressure at the point under consideration (mWG),  $H$  is the difference in level between the upper point and the point under consideration (m), and  $\Delta P$  is the sum of head-losses (m).



**Figure 11.9: Dynamic state and head losses.**

## 2.2.2 CALCULATION OF HEAD-LOSSES

To facilitate the calculation of head-losses, the losses created in the pipes and those induced by components (elbows, tees, valves etc.) are considered separately.

### 2.2.2.1 Linear head-losses

The head-losses in a pipe, called linear losses, depend on several factors:

- pipe diameter: for a given flow, the smaller the pipe the greater the losses;
- flow in the pipe: for a given diameter, head-losses increase with flow;
- pipe length;
- pipe roughness: the greater the roughness, the greater the head-losses (all things being equal). The roughness of pipes depends on their quality (materials, manufacture) and age.

Linear head-losses are generally expressed in metres head per 100 m of pipe. A head-loss coefficient of 1% therefore corresponds to a loss of 1 mWG pressure for 100 m of pipe length.

The numerical calculation of linear head-losses is usually carried out by using empirical relationships, tables or design charts (see Annex 12).

#### Formulas

There are several formulas for calculating the linear head-losses in a pipe. The most accurate (Darcy and Colebrook-White for example) need iterative calculation and are complicated to use in the field. Other methods were developed, such as the Hazen Williams formula\*, which is relatively simple to use:

$$h_F = \frac{10.9 L Q^{1.85}}{C^{1.85} D^{4.87}}$$

where  $h_F$ : head-loss (m), L: pipe length (m), Q: flow (m<sup>3</sup>/s), C: Hazen Williams coefficient (C = 150 for PVC and PE; C = 130 for GI), D: internal pipe diameter (m).

#### Use of design charts

The design chart (or nomogram) shown in Figure 11.10 represents graphically the relationship between pipe diameter, flow velocity, and linear head-losses, for a given roughness. Knowing two parameters (diameter and flow), head-losses can be deduced.

Take for example a flow of 1 l/s in a polyethylene pipe of DN 50 (50 mm outside diameter, 40.8 mm internal diameter). According to the design chart, the head-loss coefficient is 1.7%. If the head-losses are to be reduced, the line is pivoted (as shown by the arrows) around the selected flow to obtain the new pipe diameter; for a head-loss of 1% with the same flow (1 l/s) a pipe of DN 63 (internal diameter = 51.4 mm) should be used, see Table 11.V.

When using design charts, it is important to check the following points:

- the chart must correspond to the type of pipe used (PE, PVC, GI, cast iron etc.). It is essential to verify its validity when calculating head-losses using suitable formulas (see Annex 12);
- the velocity in a pipe must be close to 1 m/s. Higher velocities generate excessive friction, which may lead to hydraulic problems. On the other hand, lower velocities can allow silt deposits at points in the system if the water is turbid.

---

\* Formula valid for  $V < 3\text{ m/s}$  and  $Re > 4\,000$ , where  $V$  = velocity of the flow (m/s) and  $Re$  = Reynolds number (ratio between inertial forces and viscous forces, used to determine whether flow in the pipe will be laminar or turbulent).

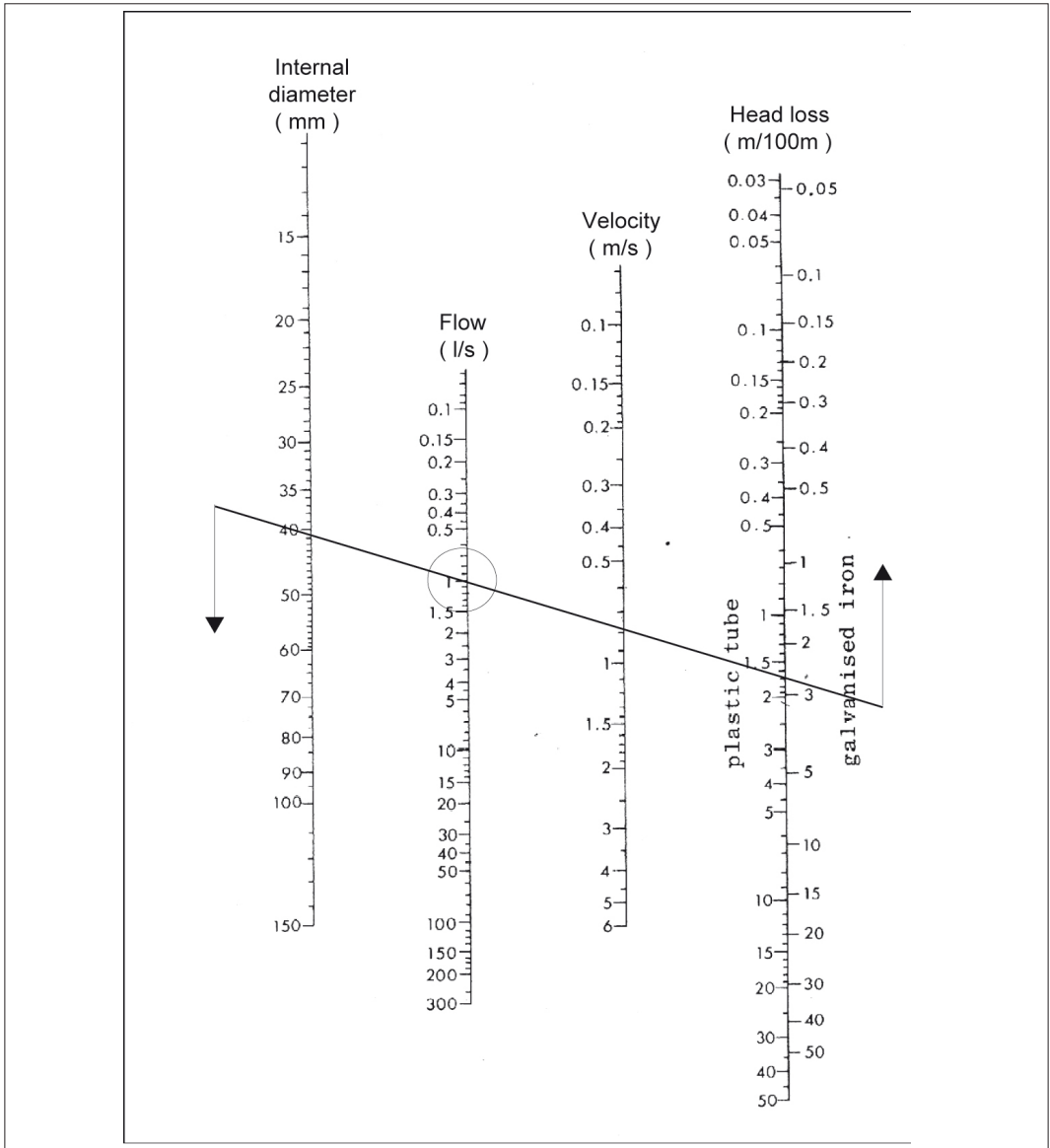


Figure 11.10: Design chart for calculating linear head-losses.

Table 11.V: Example of use of a linear head-loss chart.

Flow (l/s)	Internal diameter (mm)	Velocity (m/s)	Head-loss coefficient (%)	Head losses $\Delta P$ per km (mWG)
1	40.8 (DN 50)	0.8	1.7	17
1	51.4 (DN 63)	0.5	0.6	6



### 2.2.2.2 Secondary head-losses

In addition to the linear head-losses in pipes, there are also losses of pressure due to flow regulation devices (valves), and to passage through fittings such as elbows, tees, reducers etc. These pressure losses are known as ‘minor’ or ‘secondary’ head-losses and can be evaluated in the same way as linear losses.

In simple systems, secondary head-losses are generally small compared with linear head-losses. They are sometimes assumed to be about 10% of the linear head-losses. However, they can also be calculated using characteristic coefficients for each component. As for pipes, there are design charts or tables. Components are generally assigned equivalent straight lengths of pipe. For example, a 90° elbow in DN 50 corresponds, from the point of view of head-losses, to a length of pipe of 1.5 m of the same diameter. This allows simple calculation of the head-losses in the system.

Table 11.VI gives the equivalent lengths of pipe (in terms of friction head-loss) for common PVC or PE fittings. For GI pipes, these values must be multiplied by 0.64. When two values are given under the same category, they correspond to a range of equivalent lengths given by different parameters. Broadly speaking, screwed fittings create higher head-losses than jointed or cemented fittings.

**Table 11.VI: Equivalent length (m) for plastic components (Lencastre).**

Diameter of components (DN in mm)	12.5	25	50	75	100
Globe valve	1.83	4.78	12	20.37	30.3
	3.61	9.17	23	39.98	58.38
Gate valve	0.014	0.055	0.11	0.19	0.3
	0.055	1.66	0.41	0.75	1.11
Y-valve	1.08	2.75	6.92	11.75	17.51
Horizontal non-return valve	0.8	0.055	0.14	0.22	0.36
		2.11	5.28	9	13.42
Foot valve	5.42	13.76	34.75	58.93	87.57
Screwed reducer	0.72	0.055	0.11	0.19	0.3
		1.83	4.61	7.83	11.6
90° normal elbow	0.22	0.55	1.39	2.36	3.5
	0.33	0.84	2.08	3.53	5.25
45° elbow	0.08	0.19	0.5	0.86	1.27
	0.11	0.27	0.69	1.33	1.75
Normal tee	0.3	0.77	1.97	3.33	4.94
	0.44	1.19	3	5.08	7.58




















## 2.3 System design

The documents necessary for pipe-system design are the topographic profiles of the system as a whole, and the plan with the maximum flows for each section of the system.

Documents produced will be head profiles for the whole system, the detailed plan of the system, the summary table of profiles with all features of sections of the system, and the location of valves. The symbols usually used for structures and fittings are given in Figure 11.11.

### 2.3.1 DESIGN OF THE STORAGE TANK

In the case of gravity supplies from spring catchments, a storage tank is not always necessary. If the useful flow (calculated on maximum hourly demand) is lower than the minimum yield of the spring in one hour, a storage tank serves no useful purpose. This option also has the advantage of not requiring the installation of taps on water-collection points. If a storage tank is needed, however, it must be carefully designed (see Chapter10).

tapstand (several taps )	
tapstand (one tap)	
header tank	
sedimentation tank	
break pressure tank	
water tank n °1	
spring catchment	
protected pipe	
hanging and protected pipe	
anchor	
pump	
water meter	
ball valve	
stop cock	
adjustable maximum stop cock	
gate valve	
air valve or air vent	
well	
borehole	

**Figure 11.11: Symbols for structures and fittings.**

## 2.3.2 LOCATION OF STRUCTURES

### 2.3.2.1 Header tank

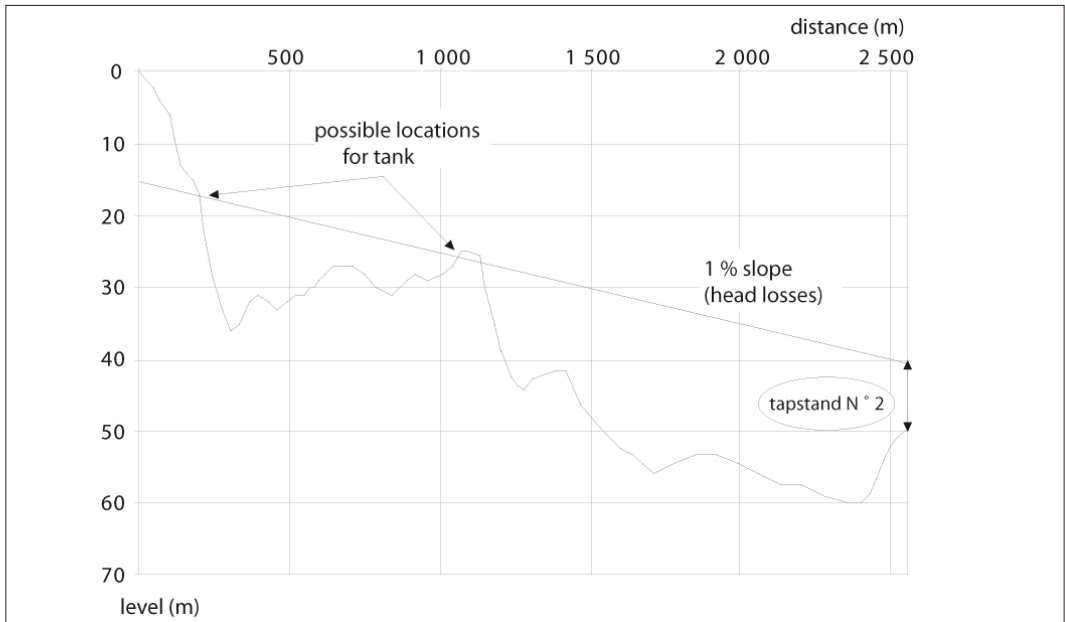
A header tank is essential in the case of gravity transmission from a spring (Figure 11.1). It isolates the spring catchment from the system hydraulically, and therefore avoids any possibility of accidental back pressure on the spring in the event of problems in the system. It also helps to even out the flow from the spring.

Site conditions and the difficulties of transporting materials often define its exact location, just downstream of the catchment. The hydraulic profile of the system begins from this point.

### 2.3.2.2 Storage tank

The location of the tank is dictated by the necessity to be able to serve the tapstands situated downstream using gravity. As a first approximation, it is assumed that the head-losses in the part of the system below the tank are the order of 1%. A straight line of 1% slope is therefore drawn starting from the highest tapstand (taking account of a minimum residual pressure of 10 mWG). Points situated below this line are unsuitable locations for the tank (Figure 11.12).

The site chosen must then be checked by calculation of head-losses. In all cases, problems of accessibility (transport of construction materials and equipment, maintenance etc.) and land ownership must be considered. The emptying time of a tank can be calculated (Box 11.1).



**Figure 11.12: Selection of tank location (example of Aloua system).**

**Two locations are possible. The upstream site is in an apparently steep area, while the lower site is on a raised area about halfway between the catchment and tapstand No. 2. Placing the tank on the lower site means it can act as a break-pressure tank to limit the maximum static pressure in the system to 35 mWG.**

### 2.3.2.3 Break-pressure tank

The necessity for and location of any break-pressure tanks are determined by the static profile survey (see Section 2.2.1).

## 2.3.3 CHOICE OF TYPES, DIAMETERS AND LENGTHS OF PIPE

### 2.3.3.1 Types of pipe

Generally, polyethylene pipes of up to 3" are favoured. Above this diameter, pipes become difficult to handle (less flexible, heavy, requiring welded joints). PVC is easy to use and available in most countries. However, galvanised steel (GI) pipes should be used for all unburied sections, gully crossings, and sections enclosed in masonry. See Section 3.3 for more detail on pipes.

### Box 11.1

#### Emptying time for a storage tank.

##### *Tank with outlet*

The emptying time of a tank with a side outlet is given by:

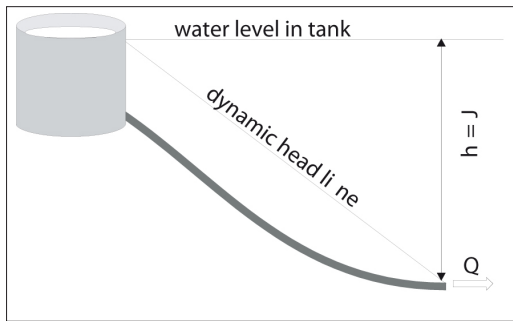
$$t = \frac{2S (\sqrt{h_1} - \sqrt{h_2})}{ks\sqrt{2g}}$$

where  $t$  is the emptying time (s),  $S$  the area of the tank ( $\text{cm}^2$ ),  $s$  the area of the outlet ( $\text{cm}^2$ ),  $g$  acceleration due to gravity (981  $\text{cm/s}^2$ ),  $h_1$  the initial height (cm) of water above the outlet,  $h_2$  the final height (cm) of water above the outlet ( $h_2 = 0$  if emptying is total), and  $k$  is a coefficient of contraction (according to the outlet,  $0.5 < k < 1$ ). For a small thin-wall outlet,  $k = 0.62$ ; for an inserted cylindrical fitting,  $k = 0.5$ ; for an external cylindrical fitting,  $k = 0.82$ .

##### *Tank connected to an open pipe – maximum gravity flow*

When the residual pressure of a pipe discharging freely to atmosphere is zero, the flow passing through the pipe is the maximum gravity flow.

In such conditions, head losses  $J$  at the end of the pipeline correspond to the total difference in level  $h$ . Knowing the distance between the two points,  $l$ , it is simple to calculate the flow  $Q$ , or to read it from a chart (Figure 1).



**Figure 1: Maximum gravity flow.**

#### 2.3.3.2 Pipe diameters

Pipe diameters are determined by the energy-profile survey and head-loss calculations.

The recommended velocity limits in pipes are maximum 3m/s and minimum 0.5 m/s.

The residual pressures in the system must be in accordance with the following rules:

- 2 to 10 mWG for entries to tanks, header tanks etc.;
- 5 to 15 mWG for taps (5 mWG for the Talbot tap);
- 10 mWG minimum in the main distribution lines, to prevent the infiltration of water from outside the pipe. The working pressure of the system guarantees the quality of water distributed.

#### 2.3.3.3 Gravity transmission (spring-to-tank line)

The part of the system feeding the tank from a spring catchment (Figure 11.1) is designed to allow the maximum flow of the spring to pass through the pipes. It is important to be able to capture and transport the total flow of the spring to the tank, even if the current needs of the population are lower than this, as it allows for the possibility of future extensions to the system. If the flow from the spring is very much greater than the needs of the population, or if it fluctuates considerably during the year, a suitable compromise must be determined.

### 2.3.3.4 Gravity distribution (tank-to-tapstand lines)

Branched-system design begins with the main line, followed by secondary lines. It then proceeds successively until the diameter chosen gives the required residual pressure.

In the example in Figure 11.13,  $P_{\text{residual}}$  is given by the difference in level between point B at ground level, and that of the piezometric profile vertically above this point. The diameter required is DN 50, because:

- for a DN 50 pipe,  $P_{\text{residual}}$  is positive and equal to 14 mWG;
- for a DN 40 pipe,  $P_{\text{residual}}$  is also positive and equal to 4.1 mWG;
- for a DN 32 pipe,  $P_{\text{residual}}$  is negative and equal to –41 mWG.

Figure 11.14 shows a high point where the pressure must be kept above 10 mWG.

It is best to use small-diameter pipes as they are less costly, and two different diameters may be used in the same line to optimise costs (Figure 11.15).

Head profiles of different lines, accompanied by an overall summary diagram, bring all this information together. The example of the line serving tapstand No. 2 of the Aloua system is illustrated in Table 11.VII and Figure 11.16.

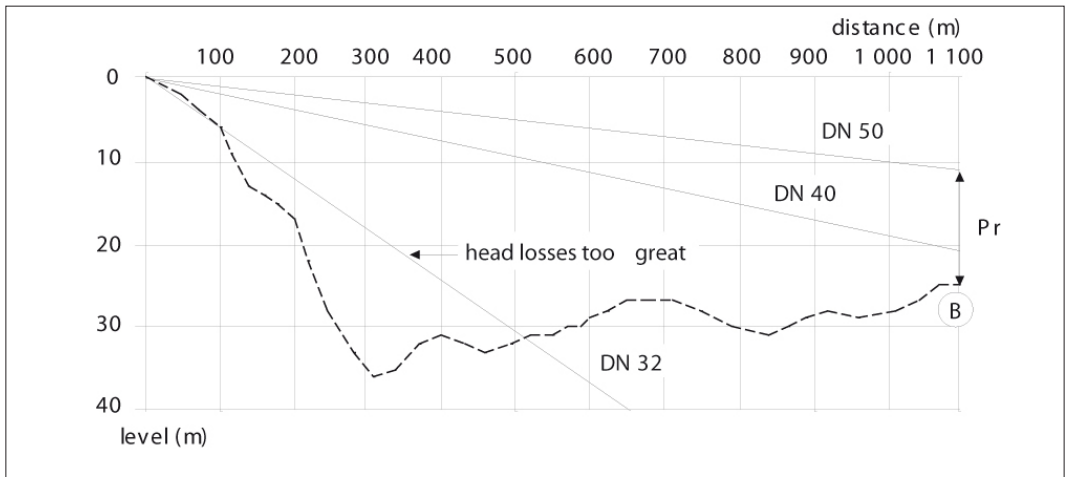


Figure 11.13: Head losses for different pipe diameters for the first part of the Aloua system.

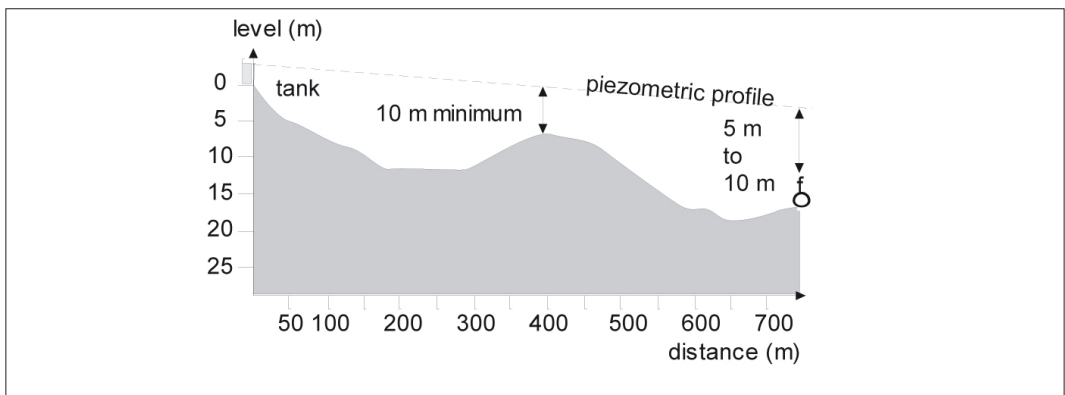
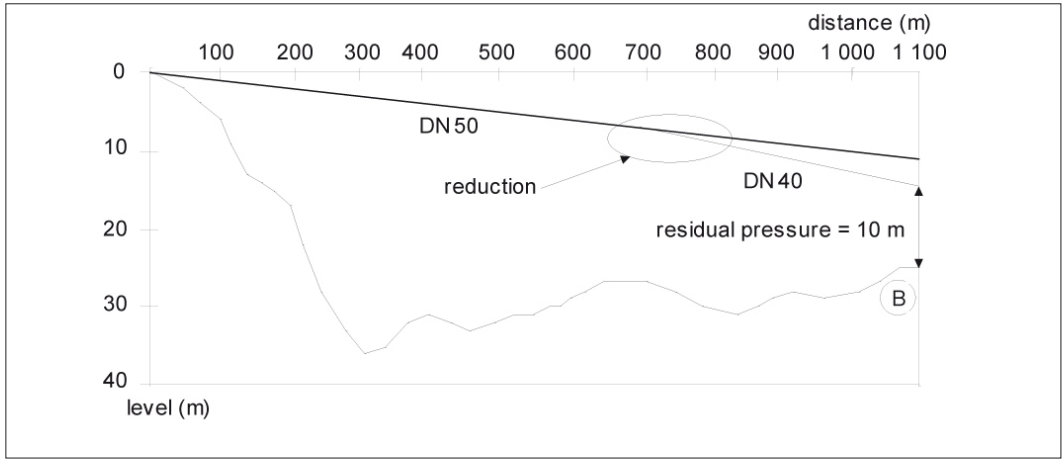


Figure 11.14: Passage over a high point.



**Figure 11.15: Combination of two pipe diameters to obtain a residual pressure of 10 mWG at Point B (example from first part of Aloua system).**

**Table 11.VII: Summary of the main line serving Tapstand No 2 of the Aloua system.**  
 **$P_s$ , static pressure.  $P_h$ , dynamic pressure.**

Point station (1)	Point station (2)	Flow (l/s)	OD (mm)	Length L (m)	$\Delta P$ (A %)	$\Delta P$ (m)	$P_h$ (1) (mWG)	Survey level (2) (m)	$P_h$ res (2)
Spring	Reduction	0.7	50	330	1	3.3	0	36	32.7
Reduction	Tank	0.7	40	770	1.9	14.7	32.7	25	7.7
Tank	J1	2.5	63	500	1.4	7	0	52	20
J1	J2	0.75	50	800	0.87	7	20	60	21
J2	TS2	0.5	40	150	0.7	1	21	49.85	10.25

**Spring - tank**

The flow taken into account for the design is the maximum flow provided by the spring. A combination of two pipe diameters is used for this section.

• Spring - Reduction

$$\begin{aligned} \text{Pressure at reduction} &= P_s \text{ reduction} && - \Delta P && \Delta P = A (\%) \times L(\text{m}) \\ P_h \text{ reduction} &= 36 && - 3.3 && = 32.7 \text{ mWG} && \Delta P = 1 \times 330 = 3.3 \text{ mWG} \end{aligned}$$

• Reduction - Tank

$$\begin{aligned} \text{Pressure at tank} &= P_h \text{ reduction} + (P_s \text{ tank} - P_s \text{ reduction}) - \Delta P && \Delta P = A (\%) \times L(\text{m}) \\ P_h \text{ tank} &= 32.7 + (25 - 36) && - 14.7 && = 7 \text{ mWG} && \Delta P = 1.9 \times 770 = 14.7 \text{ mWG} \end{aligned}$$

**Tank - Tapstand 2**

As the tank has a free surface, the pressure at its surface is zero (relative pressure).

• Tank - J1

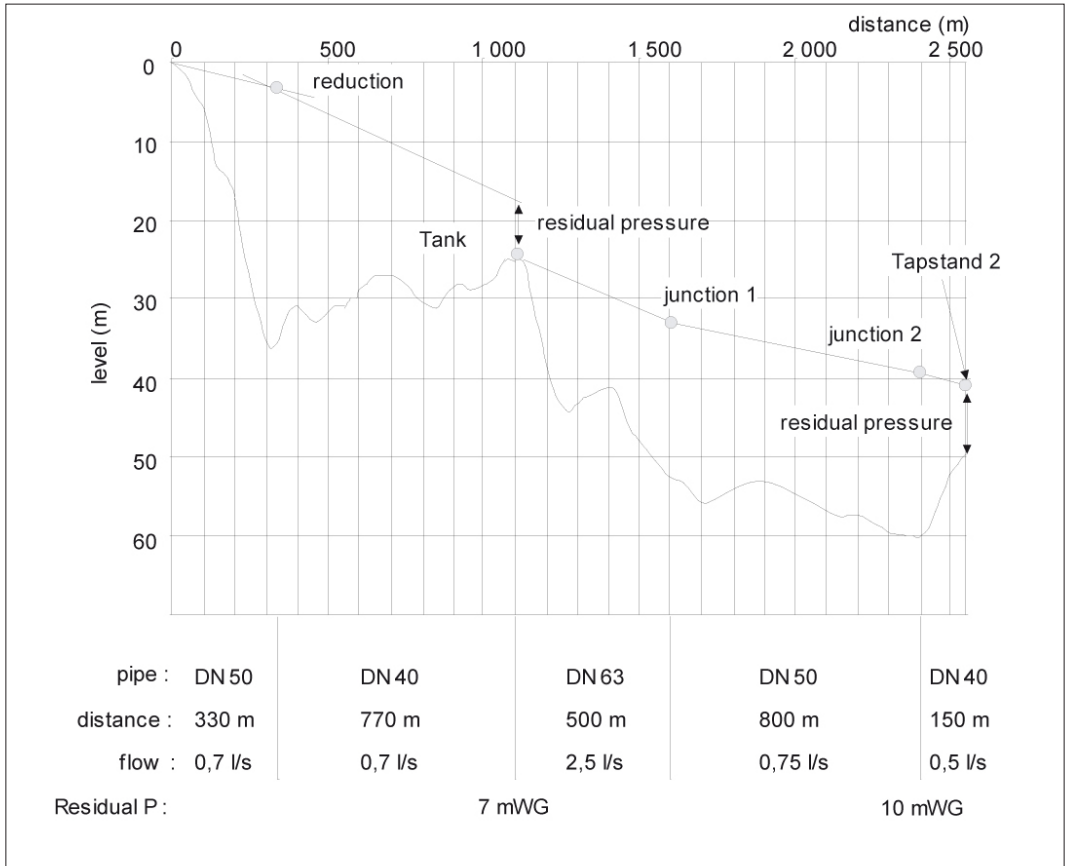
$$\begin{aligned} \text{Pressure at J1} &= P_h \text{ tank} + (P_s \text{ J1} - P_s \text{ tank}) && - \Delta P && \Delta P = A (\%) \times L(\text{m}) \\ P_h \text{ J1} &= 0 + (52 - 25) && - 7 && = 20 \text{ mWG} && \Delta P = 1.4 \times 500 = 7 \text{ m} \end{aligned}$$

• J1-J2

$$\begin{aligned} \text{Pressure at J2} &= P_h \text{ J1} + (P_s \text{ J2} - P_s \text{ J1}) && - \Delta P && \Delta P = A (\%) \times L(\text{m}) \\ P_h \text{ J2} &= 20 + (60 - 52) && - 7 && = 21 \text{ mWG} && \Delta P = 0.87 \times 800 = 7 \text{ m} \end{aligned}$$

• J2-Tapstand 2

$$\begin{aligned} \text{Residual pressure at tapstand 2} &= P_h \text{ J2} + (P_s \text{ TS2} - P_s \text{ J2}) && - \Delta P && \Delta P = A (\%) \times L(\text{m}) \\ P_h \text{ tapstand 2} &= 21 + (49.85 - 60) && - 1 && = 10.25 \text{ mWG} && \Delta P = 0.7 \times 150 = 1 \text{ m} \end{aligned}$$



**Figure 11.16: Head profile of line serving tapstand No. 2 of the Aloua system.**

### 2.3.4 SYSTEM VALVE PLAN

A certain number of valves must be installed in the system. They have different functions and must all be represented in a specific plan.

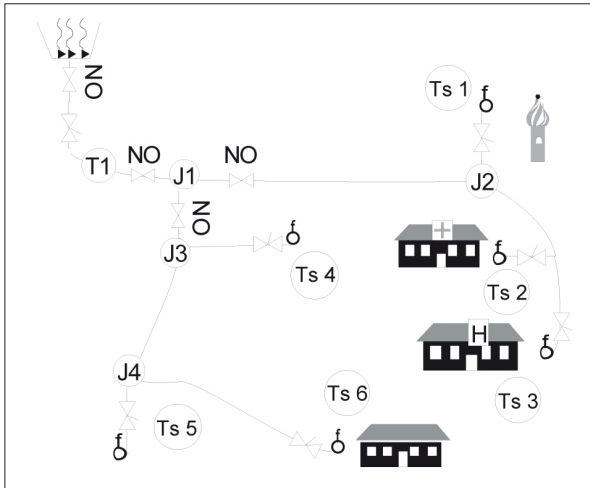
#### 2.3.4.1 Regulating valves

To ensure that the system functions properly, it is absolutely necessary to maintain flows established during design. For this reason, regulating valves are installed at inlets to every tapstand as well as at inlets to storage tanks and header tanks.

#### 2.3.4.2 Stop valves

Stop valves (such as ball valves) are installed at every major junction to allow isolation of the various branches of the system. This may be necessary in the case of leaks, or for routine maintenance work. Similarly, drain valves are fitted to all storage tanks, header tanks, and break-pressure tanks (Figure 11.17).

These valves are either “normally open” (NO) or “normally closed” (NC), depending on their function: a isolation valve is NO, while a drain valve is NC. They are all located in valve chambers which both protect them and allow easy access.



**Figure 11.17: Minimum valve plan for the Aloua system (no drains or air bleeds).**

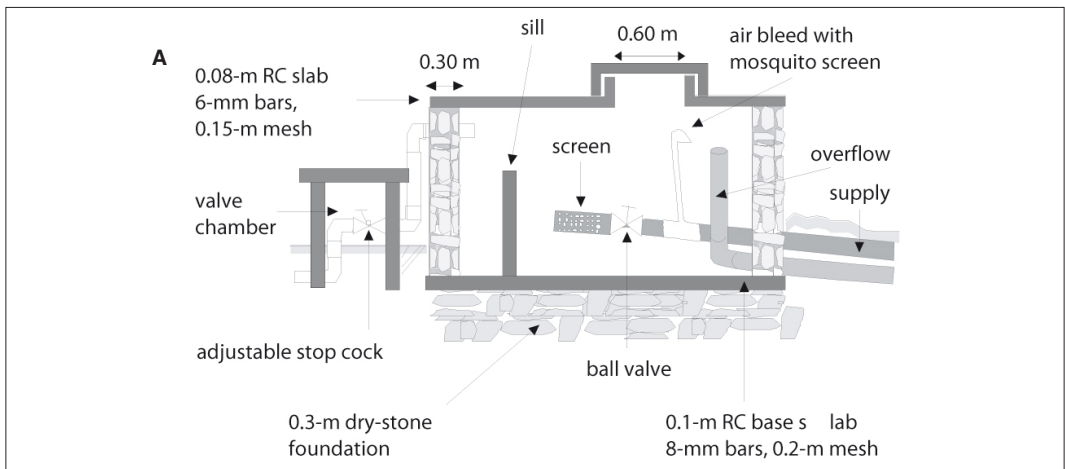
### 3 Construction of the system

The construction of a gravity system involves carrying out a number of different tasks and installing pipework. Recommendations given in this section are based on ACF experience on various projects in Africa and in Asia. Details of construction and civil engineering design are given in Annex 14.

#### 3.1 Header tanks and break-pressure tanks

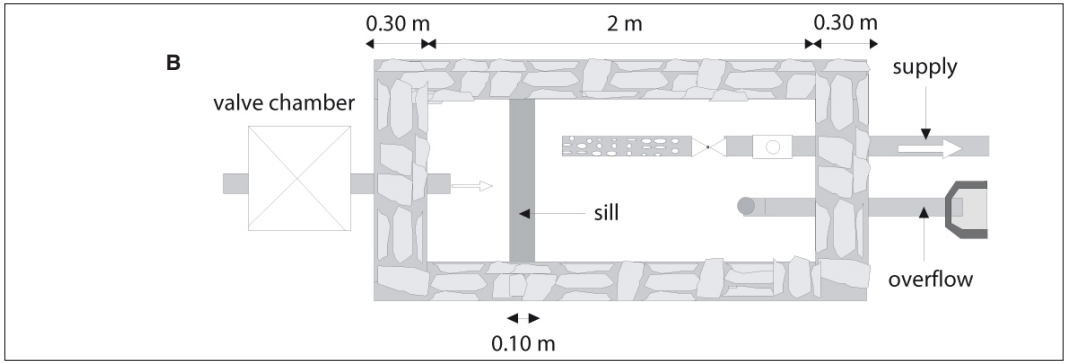
Tanks are always equipped with:

- a water inlet with a regulator valve (piston type);
- a water outlet with a stop valve (ball type) and air vent;
- a drain;
- an overflow;
- an inspection trap.



**Figure 11.18: Masonry break-pressure tank. A: section.**

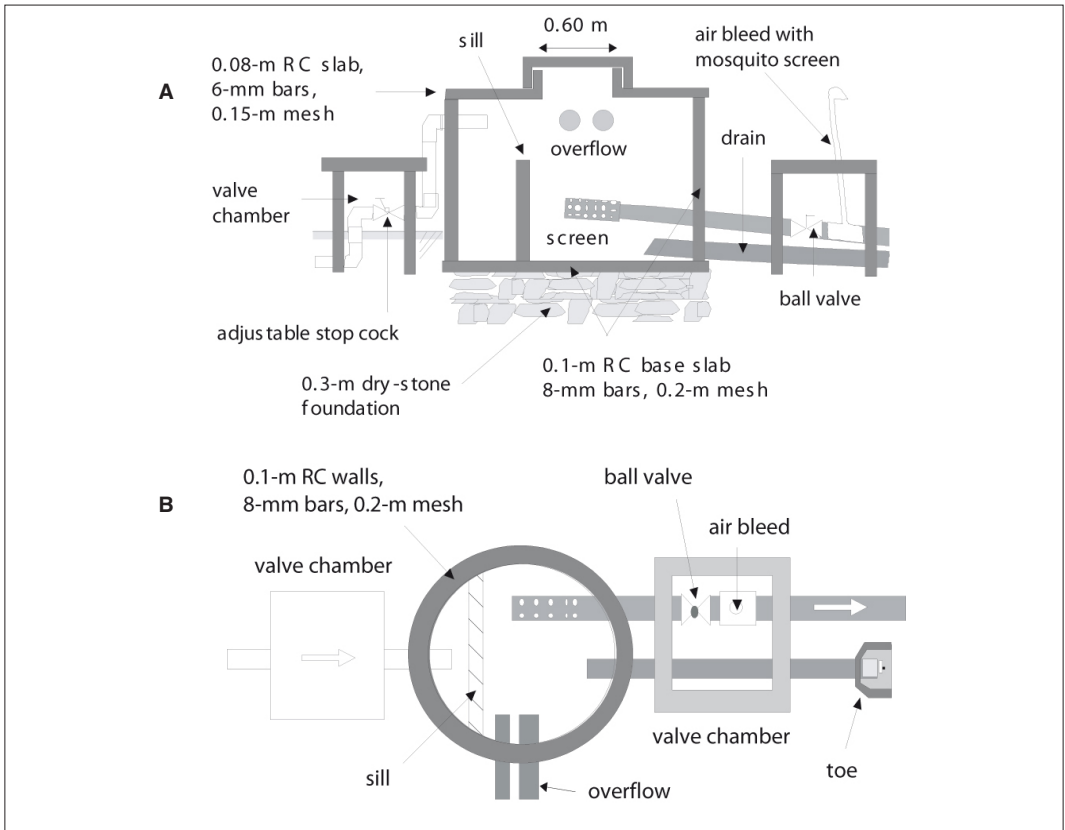




**Figure 11.18: Masonry break-pressure tank. B: plan.**

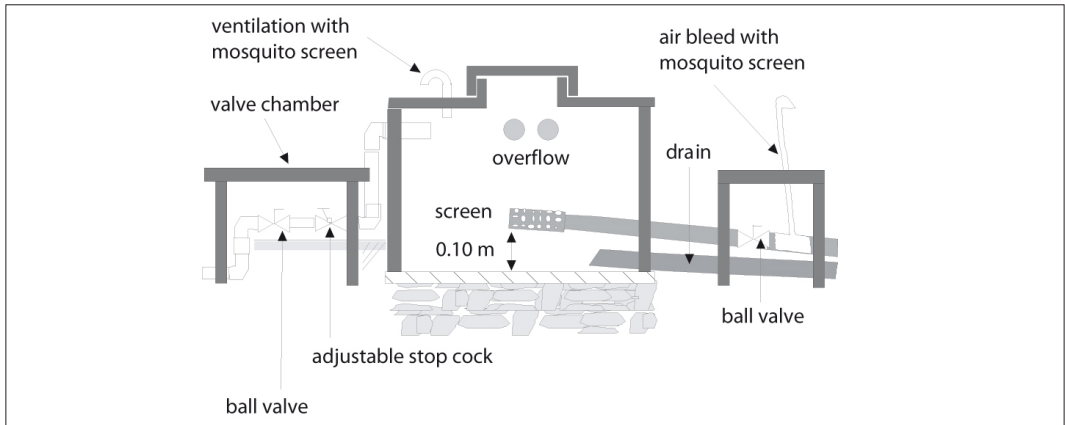
The construction can be in masonry or in reinforced concrete (Figures 11.18 & 11.19), the volume is 2 to 3 m<sup>3</sup>, and of rectangular or cylindrical shape (prefabricated rings are used).

The installation of a sill in break-pressure tanks is recommended to diffuse the dynamic pressure and facilitate good aeration of the water. Also, the depth of the water layer over the sill gives a measure of incoming flow (see Chapter 3).



**Figure 11.19: Reinforced concrete break-pressure tank.**

**A: section. B: plan.**



**Figure 11.20: Storage tank.**

## 3.2 Storage tank

A storage tank (Figure 11.20) requires:

- a water inlet with adjustable stop cock;
- a water outlet with ball valve and air vent;
- a drain;
- an overflow;
- an inspection trap.

The construction of tanks in reinforced concrete and in masonry is described in Annex 14.

## 3.3 Pipes

### 3.3.1 PIPES AND COMPONENTS

#### 3.3.1.1 Equivalent diameters

Nominal diameters of pipe are designated by DN sizes under the ISO system. DN sizes for galvanised steel (GI) pipes refer to the internal diameter (ID), whereas for rigid plastic pipes (PVC and PE) they refer to the outside diameter (OD) (Table 11.VIII).

**Table 11.VIII: Equivalent pipe diameters.**

PVC/PE pipes		GI pipes	
OD in mm	equivalent diameter OD in inches	ID in inches	equivalent diameter ID/OD in mm
16		3/8"	12/17
20	3/4"	1/2"	15/21
25	1"	3/4"	20/27
32	1"1/4	1"	26/34
40	1"1/2	1"1/4	33/42
50	2"	1"1/2	40/49
63	2"1/2	2"	50/60
75	3"	2"1/2	66/76
90	3"1/2	3"	80/90
110	4"1/2	4"	102/114

### 3.3.1.2 Pressure classes

Nominal pressure (NP) is usually expressed in bar (NP 6, NP 10, NP 12.5 etc.). Some countries, such as Kenya and India, have their own standards of pressure resistance (see Table 11.IX).

The service pressure is different from the nominal pressure under particular conditions (elevated water temperature, corrosive water etc.). For most programmes, only nominal pressure is used.

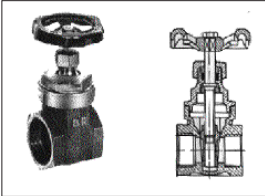
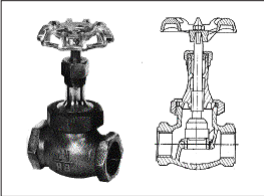
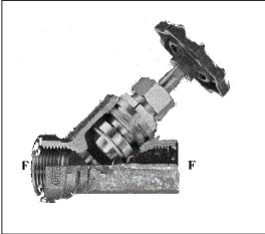



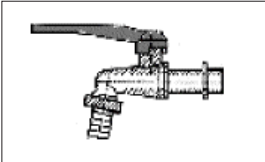
**Table 11.IX: Nominal pressure equivalents (NP).**

PE pipe NP (bar)	Equivalent class	PVC pipe NP (bar)	Equivalent class	GI pipe NP (bar)
NP 6	Class B or III	NP 6	Class B or III	NP 16
NP 10	Class C or IV	NP 10	Class C or IV	NP 25
NP 12.5	Class D	NP 16	Class E	

### 3.3.1.3 Valves and taps

The various models of valves and taps are shown in Table 11.X.

**Table 11.X: Models of valves and taps.**

Model	Name and use	Model
	<i>Gate valve</i> opening/closing possible flow regulation, but stop cock preferable	
	<i>Adjustable stop cock</i> regulation of flow with adjustable maximum opening (concealed stop screw) possible opening/closing, but gate or ball valve preferred	
	<i>Float valve</i> automatic opening/closing according to water level (storage tank, header tank) level control	
	<i>Ball tap</i> public distribution if Talbot not available (with fluted mouthpiece for attaching a hose pipe)	

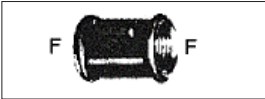



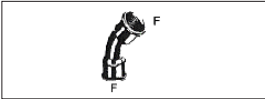






### 3.3.1.4 GI pipes and fittings

GI pipes are generally available in 6-m lengths. Their properties and the various fittings available are listed in Tables 11.XI and 11.XII.

**Table 11.XI: Relationship between internal diameter and weight per metre for galvanised steel pipes.**

Diameter (inches)	3/4"	1"	1"1/2	2"	2"1/2	3"
Weight (kg) per m	1.6	2.4	3.6	5	6.5	8.4

**Table 11.XII: Fittings for GI pipes.**

Model	Name and use	Model
	<i>Socket</i> joining 2 pipes	
	<i>Union</i> joining 2 pipes, disassembly possible	
	<i>45° elbow</i> joining 2 pipes at 45°	
	<i>Reducer</i> female-female reduction	
	<i>Reducer</i> male-female reduction	
	<i>Cap</i> female pipe end	

GI pipes are joined using a screwed socket, also in galvanised steel. Each pipe is threaded at both ends and normally delivered with a socket. Sealing is ensured with Teflon tape for small diameters, and with hemp and jointing compound for diameters above 1"1/2.

Special tools are needed when working with these pipes:

- stock and die for threading pipes (standard die cuts from 1/2" to 2"1/2 with three sets of dies);
- pipe-cutter;
- plumber's vice.

### 3.3.1.5 PVC pipes and fittings

PVC pipes and fittings are generally available in 6-m lengths, packed in bundles (Figure 11.21). There are various types of joint for PVC pipes (Table 11.XIV):

- rubber joints (Figure 11.22A), generally used for larger diameters (Table 11.XV). It is recommended to use soapy water when connecting pipes with rubber joints in order to ensure that the joint slips fully home;
- glued joints (Figure 11.22B), generally used for small diameters, Table 11.XIII);
- sockets (using cut pipes – Figure 11.22C).

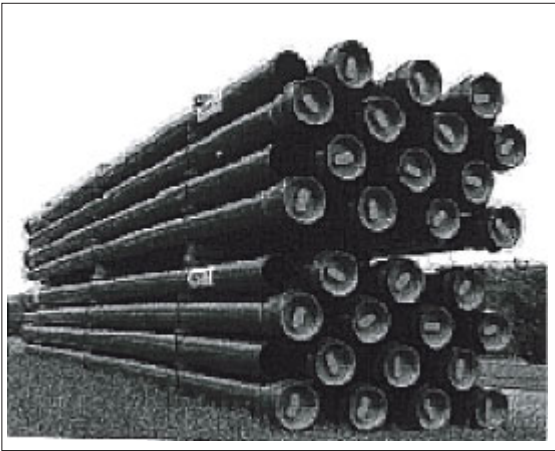


Figure 11.21: PVC pipes with glued joints.

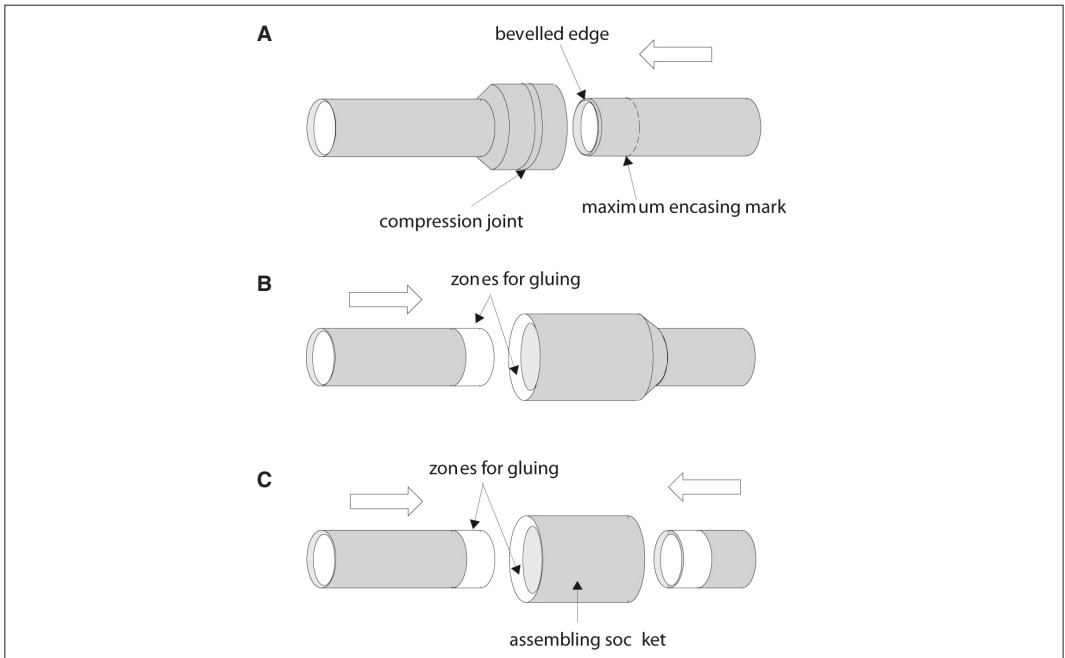




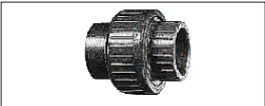







Figure 11.22: PVC pipe joints.

A: rubber joint. B: glued joint. C: socket joint.

**Table 11.XIII: PVC pipe with glued joints, NP 10.**

Outside diameter (mm)	Internal diameter (mm)	Weight (kg) per m
32	29.2	0.3
40	36.4	0.5
50	45.2	0.8
63	57	1.2
75	69	1.6
90	84	1.8

**Table 11.XIV: Fittings for PVC pipes.**

Model	Name and use	Model
	<i>Socket</i> joining 2 pipes	
		<i>Union</i> joining 2 pipes, disassembly possible
	<i>90° elbow</i> joining 2 pipes at 90°	
		<i>45° elbow</i> joining 2 pipes at 45°
	<i>90° tee</i> joining 3 pipes of the same diameter	
		<i>Reducer</i> joining 2 pipes of different diameters
	<i>Male adaptor</i> joining PVC-GI, PVC-valves etc.	
		<i>Female adaptor</i> joining PVC-GI, PVC-nipples etc.
	<i>Hose socket</i> joining PVC-flexible pipes, with hose clamp	
		<i>Plug</i> 

**Table 11.XV: PVC pipes with rubber joints.**

Outside diameter (mm)	Internal diameter (mm)
63	57
75	69
90	83
110	101.4
125	116.2
140	130.2

### 3.3.1.6 Polyethylene pipes and fittings

Polyethylene (PE) pipes usually come in 50 or 100-m coils (Figure 11.23), and are available in different qualities: high, medium, and low density (Table 11.XVI). High-density pipe is generally used for drinking water. However, it is more rigid, and medium density PE pipe can be used for connections to tapstands or tanks.

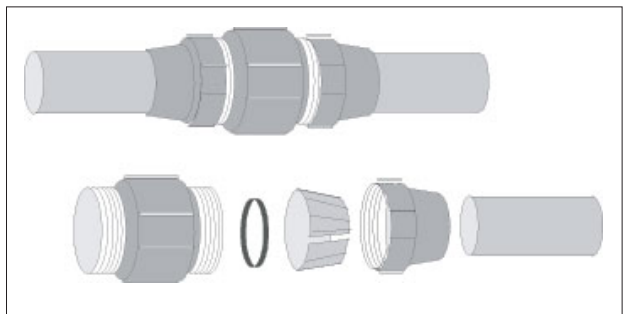


**Figure 11.23:** PE pipes.

**Table 11.XVI:** Characteristics of high density and low density PE pipes.










Outside diameter (mm)	Internal diameter (mm)	Weight (kg) per metre
<i>High density, NP 10</i>		
32	26	0.3
40	32.6	0.45
50	40.8	0.7
63	51.4	1.0
75	61.4	1.5
90	73.6	2.2
<i>Low density, NP 10</i>		
25	16.6	0.3
32	21.2	0.45
40	26.6	0.7
50	33.4	1.0
63	42	1.7

Compression couplings are used for connecting PE pipes up to 2”1/2 in diameter (Table 11.XVII & Figure 11.24). For larger diameters, it is preferable to use heat welding.



**Figure 11.24:** PE compression coupling.




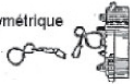

**Table 11.XVII: Fittings for PE pipes.**

Model	Name and use	Model
	<i>Coupling</i> joining 2 pipes	
		<i>Union</i> joining 2 pipes, disassembly possible
	<i>90° elbow</i> joining 2 pipes at 90°	
		<i>45° elbow</i> joining 2 pipes at 45°
	<i>90° tee</i> joining 3 pipes of the same diameter	
		<i>Reducer</i> joining 2 pipes of different diameters
	<i>Male adaptor</i> joining PE-GI, PE-valves, etc	
	<i>Female adaptor</i> joining PE-GI, PE-nipples, etc	
	<i>Plug</i>	

**3.3.1.7 Quick-fit connections**

These fittings (Table 11.XVIII) are mainly used in emergency systems, for connections to water tankers, tapstands etc.

**Table 11.XVIII: Quick-fit pipe components.**


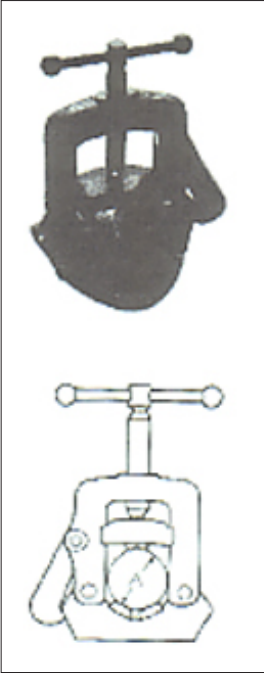





Model	Name and use	Model
	<i>Quick hose coupling</i> connection to flexible hose with locking collar	
		<i>Quick hose coupling</i> connection to female threaded components (valves etc.)
	<i>Quick hose coupling</i> connecting to GI pipe or male threaded component (nipple etc.)	
	<i>Dust plug with locking ring</i> plug for semi-symmetrical quick connections	
		<i>Wrench</i> for tightening quick-fit joints



3.3.1.8 Standard tools

These tools are shown in Table 11.XIX.

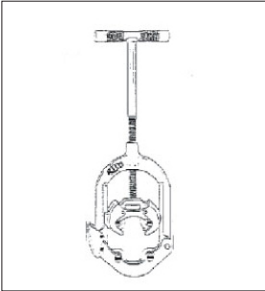
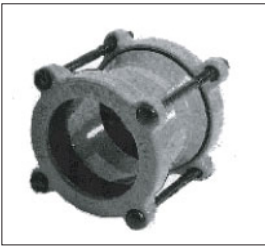
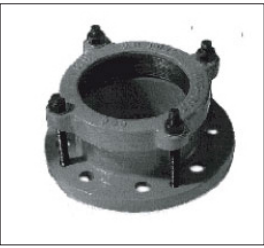
**Table 11.XIX: Standard tools for GI pipes.**

Model	Name and use	Model
	<p><i>Stillson pipe wrench</i> <i>Heavy-duty pipe wrench</i></p>	
	<p><i>Chain pipe wrench</i></p>	
	<p><i>Manual thread cutter with arm</i></p>	<p><i>Pipe vices</i></p>
	<p><i>GI pipe cutter</i></p>	
	<p><i>Pipe cutter wheel</i></p>	

### 3.3.1.9 Accessories for repair and connection of cast-iron pipe

These accessories are shown in Table 11.XX.

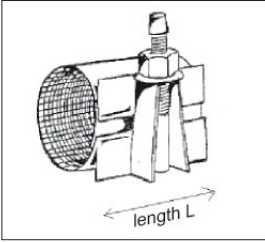
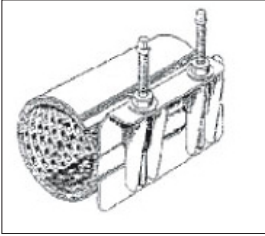
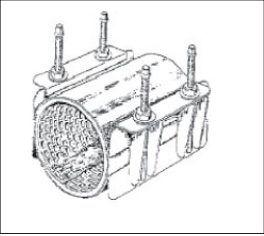
**Table 11.XX: Accessories for repair and connection of cast-iron pipe.**

Model	Name and use	Model
	<p><i>Pipe cutter</i></p> <p>This type of pipe cutter can be used for GI pipes. There are also less expensive two-wheel models which are very convenient for work above ground.</p> <p>For PVC and PE pipes, a metal saw is adequate. There is a 4-wheel model for work with reduced clearance, for instance, in a pipe trench (90°)</p>	
	<p><i>Repair clamp</i></p> <p>high-tolerance joint (seals joint with locking pins) for connecting pipes of the same outside diameter, whatever their material or thickness</p>	
	<p><i>Adaptor</i></p> <p>same type for adaptation on flange; with a flange washer</p>	

### 3.3.1.10 Equipment for pipe repair

This equipment is shown in Table 11.XXI.





**Table 11.XXI: Equipment for pipe repair.**

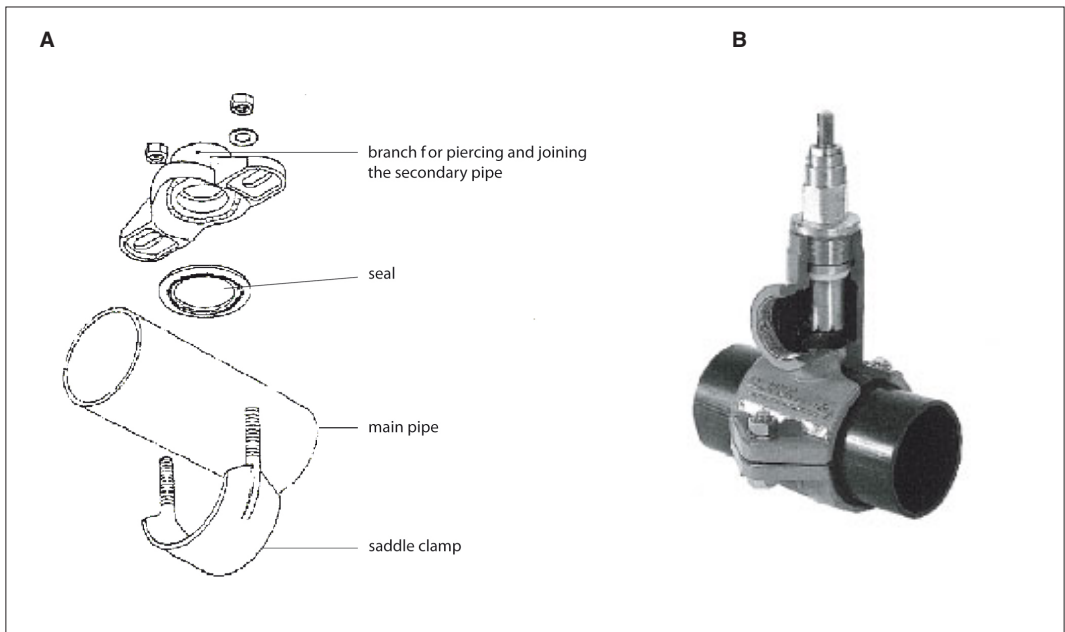
Model	Name and use	Model
	<p><i>Repair clamp</i></p> <p>single model for rapid repair of all type of pipe: asbestos cement, cast-iron, GI, PVC, length 100 mm</p>	
	<p><i>Repair clamp</i></p> <p>model identical to the previous one, 200 and 250 mm in length</p>	
	<p><i>Repair clamp</i></p> <p>double model; length 200 to 300 mm; 400 mm for 200 - 400 mm dia. pipe; 500 mm for 350 - 500 mm dia. pipe</p>	

### 3.3.1.11 Equipment for pipes under pressure

This equipment (Table 11.XXII & Figure 11.25) enables work to be carried out on a pipe under pressure without interrupting distribution. It is used particularly when connecting tapstands or private connections.

**Table 11.XXII: Equipment for pipes under pressure.**

Model	Name and use	Model
	<i>Tapping saddle clamp</i> all types of pipe (PE, PVC, cast-iron, GI, asbestos, cement), delivered with washer	
	<i>Connector tap</i> male or female outlet, gas-fitting thread	
	<i>Tapping saddle clamp</i> for PVC and PE, ductile cast-iron, GI, asbestos and cement	
	<i>Hole cutter</i> equipment for piercing pipe and fitting saddle clamp and connector tap	



**Figure 11.25: Tapping saddle clamp.**  
A: details. B: with integral cutting valve.

### 3.3.2 INSTALLING PIPES

#### 3.3.2.1 Trench

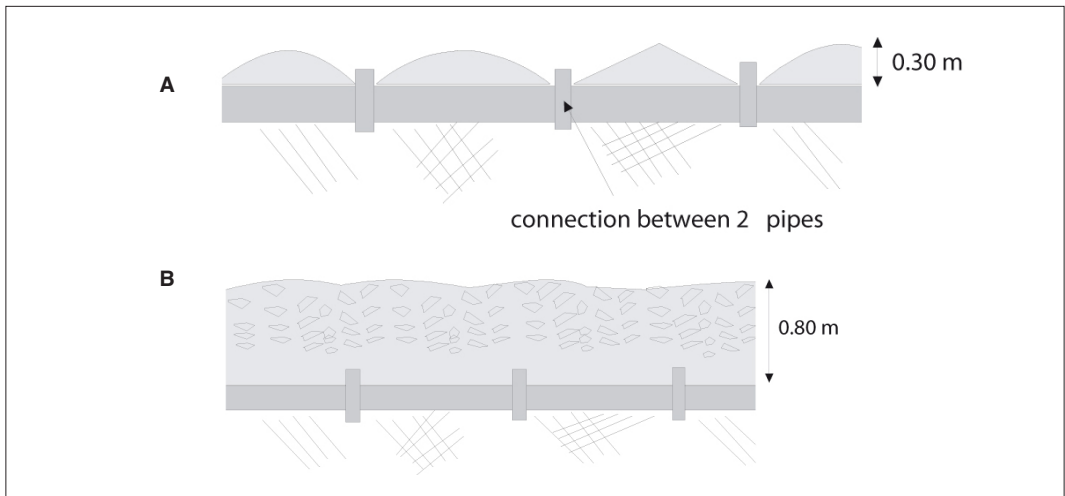
- Minimum depth: 0.8 m (width = tool width).
- Remove stones and roots that could damage the pipe.
- Dig the trench just before laying the pipe to avoid all risk of collapse or erosion by flood-water in the event of rain. If this is not possible, place earth dams inside the trench as often as the slope requires.

#### 3.3.2.2 Pipe laying

- If the bottom of the excavation is not flat, or if the earth could damage pipes (e.g. weathered rock), place a layer of sand, or sieved earth if sand is not available, on the bottom of the trench.
- Lay the pipes, joining them carefully (pay attention to problems of pipe expansion, especially when using long polyethylene pipes in high temperatures).

#### 3.3.2.3 Backfilling

- Use the excavated earth for backfilling (remove anything that could damage the pipe).
- After laying the pipe, fill to 30 cm, then compact correctly. If possible, pressurise the system and check for leaks (Figure 11.26A).
- Finish off filling and compaction (Figure 11.26B).



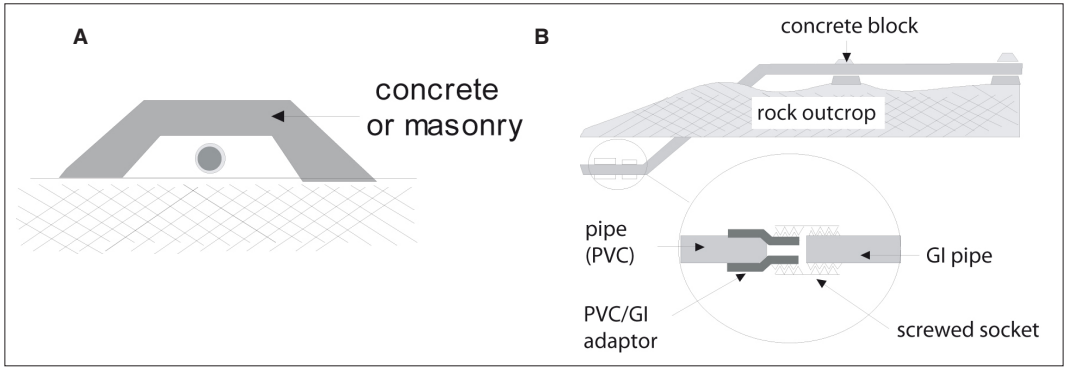
**Figure 11.26: Backfilling the pipe trench.**

**A: initial backfilling to test the pipes (pressurise system). B: final backfilling after pipe test.**

#### 3.3.2.4 Passage above ground

When it is not possible to bury the pipe deeper than 30 cm, several other solutions are available (Figure 11.27A):

- use GI pipes;
- put a protective sleeve around the pipe;
- protect plastic pipe with a concrete (10 cm) or masonry covering which may be above ground if necessary.



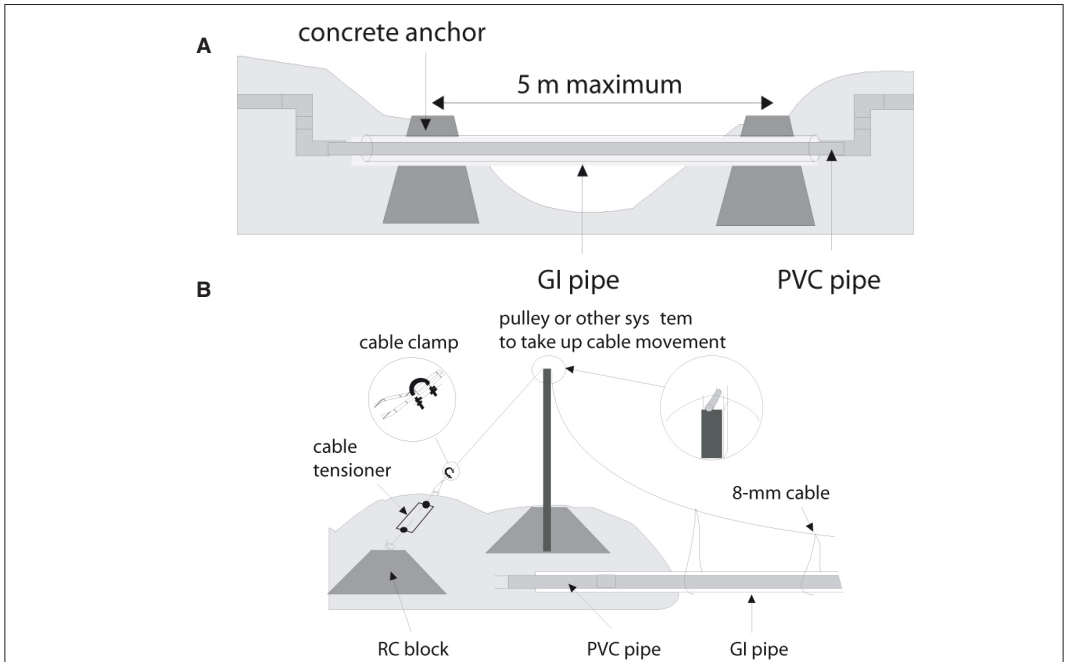
**Figure 11.27: Passage above ground.**  
**A: masonry protection for pipe. B: use of GI pipe.**

In the case of crossings over gullies, rivers etc.:

- if the span is less than 5 m, the use of GI pipe is recommended. These pipes will easily bear their own weight over a length of 5 m. If the line is in plastic pipe, a GI pipe may be used as a sleeve (anchor the extremities of GI pipe in concrete blocks – Figure 11.28A);
- if the span is greater than 5 m, it is essential to support the pipe with cable.

**Table 11.XXIII: Diameter of pipe and maximum span with a 8 mm diameter cable.**

Pipe diameter	1"	2"	3"
Maximum span	170 m	70 m	40 m



**Figure 11.28: Crossing over ravines or rivers.**  
**A: use of a GI sleeve. B: suspended pipe.**

The following aspects should be given special attention:

- the cable must be well anchored;
- the PVC pipes must pass inside the GI pipes;
- pipes must be suspended from the cable every 70 cm.

The diameter of the cable is selected according to the length of the span and the diameter of the pipe (Table 11.XXIII & Figure 11.28B).

### 3.3.2.5 Crossing under a road

- Bury pipe at least 1 m deep.
- Use GI pipe, a GI sleeve, or a concrete conduit.

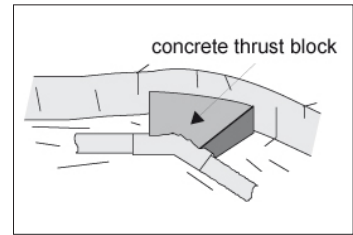
Sleeve diameters are chosen according to diameters of pipes (Table 11.XXIV).

**Table 11.XXIV: Respective diameters of pipes and sleeves.**

Plastic pipe	40 mm	50 mm	60 mm	75 mm
GI sleeve	2"	2"1/2	3"	4"

### 3.3.2.6 Thrust blocks

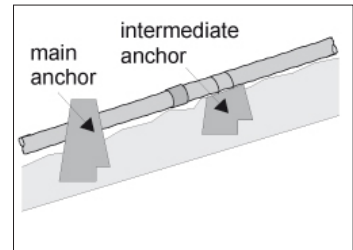
Thrust blocks (Figure 11.29) are essential to support elbows, tees and valves.



**Figure 11.29: Thrust block.**

### 3.3.2.7 Anchors

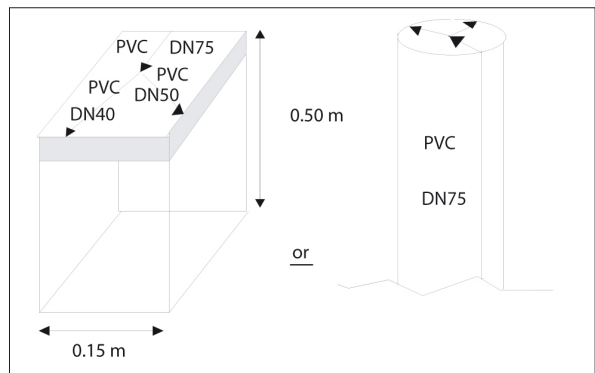
On very steep slopes (or where the terrain is unstable), the pipe must be anchored (Figure 11.30) to prevent movement when it is filled with water. It is important to use as many anchors as necessary.



**Figure 11.30: Pipe anchors.**

### 3.3.2.8 Location markers

To indicate the position of the pipeline, location markers are placed in concrete or masonry every 250 m, and at specific points (branches, changes of direction etc.). These indicators should be marked with the type of pipe (material and diameter) and direction of flow, plus a reference number (Figure 11.31).



**Figure 11.31: Pipeline markers.**

### 3.3.2.9 Drain valves

Ball valves are installed at low points in the line, so as to be able to drain pipes and remove deposits of silt (Figure 11.32).

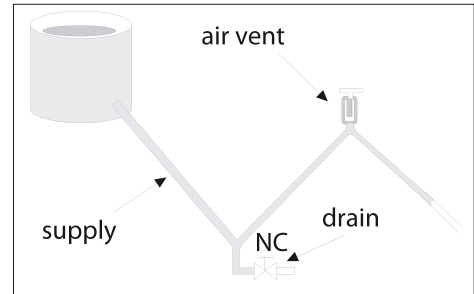


Figure 11.32: Drain and air vent.

### 3.3.2.10 Air vents

Ball valves are installed at high points in the line, in order to vent accumulated air. These valves are open at the time the system is filled with water, and are then regularly opened when the system is checked.

Air valves, installed at high points, allow automatic removal of air trapped in the pipe, and facilitate maintenance.

### 3.3.2.11 Valve chambers

All valves, along the line as well as at tapstands, tanks etc., must be protected in valve chambers, and should be:

- fitted with screw-down cover;
- provided with a drain for infiltration water;
- large enough to allow easy disassembly and replacement of the valve.

All valve handles must be removed and retained only by the person responsible for the system, to avoid unauthorised operation.

All valves must be fitted between two unions to permit disassembly without cutting the pipe.

## 3.4 Tapstands

Tapstands must allow easy and hygienic distribution of water for users of the system.

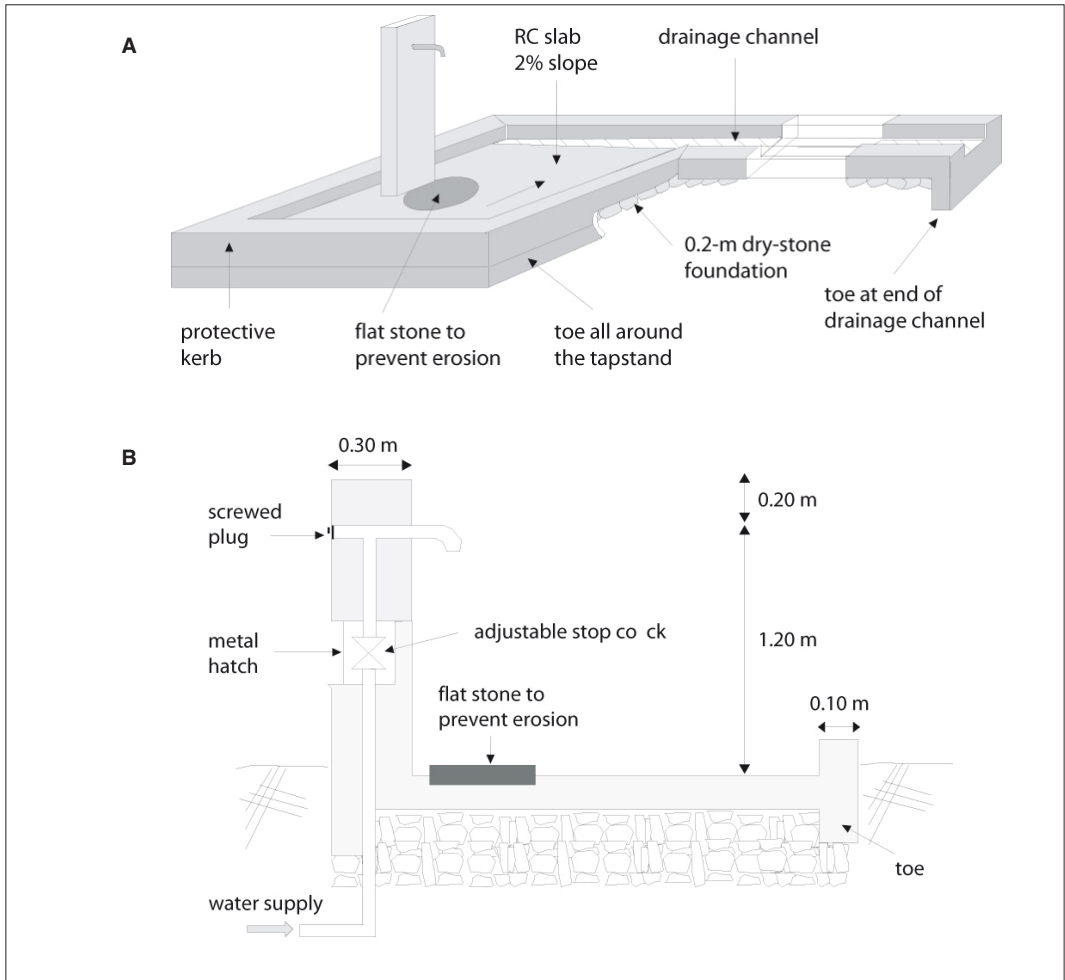
### 3.4.1 FITTINGS

It is generally considered that 3/4" taps provide a flow of 0.25 l/s at 10 mWG. Talbot taps cannot reach these flows, and only produce about 0.1 to 0.15 l/s at 5 mWG. In addition, they function correctly only under low pressure, around 1 to 8 mWG. Above 8 mWG they become very difficult to open. However, they have the advantages of closing automatically and being rugged. Their use is therefore recommended, but their correct working range must be borne in mind.

All tapstands must be fitted with a regulating valve (adjustable stop cock) or, better, a pressure regulator. This device enables the service pressure to be pre-set, and therefore ensures optimal operation of the taps. If pressure regulators are installed (strongly recommended), the tapstand must also be fitted with a stop cock or other valve that normally remains open.

### 3.4.2 CONSTRUCTION

Figures 11.33 and 11.34 show two types of tapstand, in reinforced concrete or masonry, with 1 or 4 taps: details of the structure are given in Annex 14. Many designs are possible and they must be adapted to the cultural context. As it is a meeting place, the tapstand is a social facility that deserves special attention in both design and structure. Users must be involved in its development, as this is



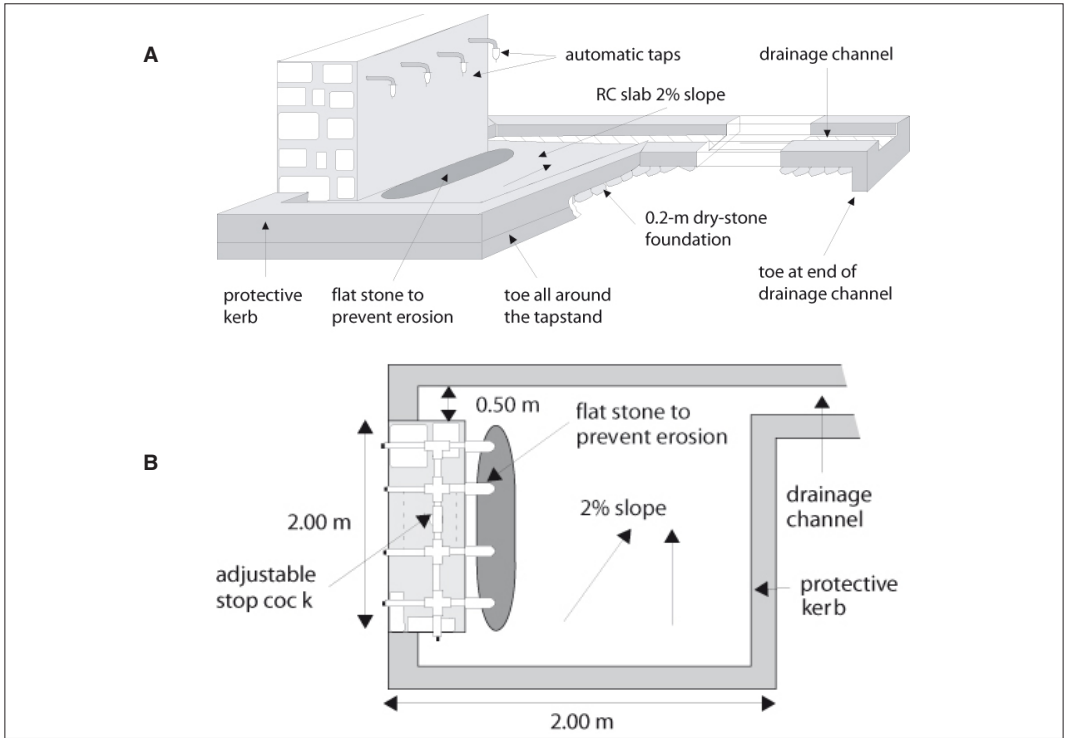
**Figure 11.33: Reinforced-concrete tapstand with one tap.**  
**A: general view. B: section.**

the only guarantee of basing its design on local preferences for water-drawing (shape of containers, height of taps, washing habits etc.). An example of a tapstand design developed with a local community in Ethiopia is given Chapter 10B.

It is important to pay attention to the following technical points:

- set a flat stone where water flows onto the ground, to avoid rapid erosion of the concrete slab;
- create a definite slope in the slab toward the drainage channel (about 2%);
- make the drainage channel an integral part of the slab design, make it as long as necessary, and finish it with a toe;
- if necessary, install a barrier to prevent access to the tapstand by animals;
- ensure the slab is raised at least 10 cm above ground level to prevent ingress of surface water.





**Figure 11.34: Masonry tapstand with 4 taps.**  
**A: general view. B: plan.**

## B FIELD EXAMPLES

<b>1</b>	<b>Gravity-flow water systems on spring catchments</b>	420	<i>3.1.2 Flocculation-sedimentation</i>	436
1.1	Planning	420	<i>3.1.3 Disinfection and storage</i>	436
1.2	Human and financial resources	421	<i>3.1.4 Mobile treatment unit</i>	436
1.3	Example of the Ban Houn system	422	<i>3.1.5 Constructing an OXFAM-type rigid tank</i>	436
<b>2</b>	<b>Emergency distribution systems from boreholes</b>	434	<i>3.1.6 Filtration-flocculation</i>	436
2.1	Implementation	434	3.2 Example of the Aswha system	437
2.2	Human and financial resources	434	<i>3.2.1 Pumping station and distribution system</i>	437
<b>3</b>	<b>Emergency systems from rivers</b>	435	<i>3.2.2 Operation</i>	438
3.1	Implementation	435	<i>3.2.3 Human resources and station management</i>	439
3.1.1	<i>Pumping</i>	436	<i>3.2.4 Equipment costs</i>	439

### 1 Gravity-flow water systems on spring catchments

Projects must be planned and implemented in collaboration with the community and its leaders. It is important to take into consideration the special characteristics of each community and to plan the development of the project with the local population.

#### 1.1 Planning

The time necessary for the construction of a gravity-flow system depends on numerous factors (Table 11.XXV): participation of the community, length and complexity of the system, weather conditions (important above all for digging the trench) etc.

Work planning for the Aloua system shown in Chapter 11A is given in Table 11.XXVI.

**Table 11.XXV: Example of time required for the main works in the construction of a gravity-flow water system.**

Spring catchment	5 weeks – 10 persons
Constructing storage tank	1 month – 8 persons
Constructing tapstand	1 to 2 weeks – 5 persons
Digging trench (80 cm)	5 m/person/day
Installing pipes	50 m/person/day
Backfilling trench	8 m/person/day

**Table 11.XXVI: Timetable for the implementation of the Aloua system.**

Month	Activities
1	Field survey (resources, demand) on site, contact with the community Plan of the village Topography Design calculations
2	Purchase of materials and equipment (pipes, cement, moulds etc.) Recruitment of labourers Planning community participation programme
3	Spring catchment Construction of particular structures (header / sedimentation tanks, break-pressure tanks etc.) Implementation of community participation programme
4	Construction of storage tank Continuation of community participation programme
5	Construction of 3 tapstands Continuation of community participation programme
6	Construction of 4 tapstands Start of trench-digging, installation of pipes, partial backfilling Continuation of community participation programme
7	Completion of construction of tapstands Completion of pipe installation, backfilling trench Continuation of community participation programme
8	Filling pipes with water Repairing leaks Completion of site (fencing around tapstands etc.) Evaluation, new proposals

## 1.2 Human and financial resources

The skilled jobs for the construction of a gravity-flow system are pipe-laying and civil engineering, which may or may not be sub-contracted. When working directly, two teams are used, one for plumbing (connection and installation of the pipes) and the other for civil engineering (Table 11.XXVII). Community members can be involved in some of the tasks, particularly:

- clearing the pipe routes and transport of materials along the line;
- digging the trenches;
- managing wastewater from tapstands and erecting fences or hedges around the spring and tapstands.

**Table 11.XXVII: Personnel required for the construction of a distribution system.**

<i>Management</i>	
1 water technician	Design, planning, management of the teams
1 logistician	Supplies to the site, follow-up of material and vehicles
1 foreman	Overseeing plumbing and brickwork teams
<i>Masonry team</i>	
1 mason foreman	In charge
2 assistant masons	Preparation, concrete work
<i>Plumbing team</i>	
1 plumber foreman	In charge of installation and connection of pipes
2 assistant plumbers	Laying and connection of pipes
<i>Labourers</i>	
Depending on demand	Trenches, building, plumbing

Table 11.XXVIII shows estimates of the cost of materials and equipment in 1997.

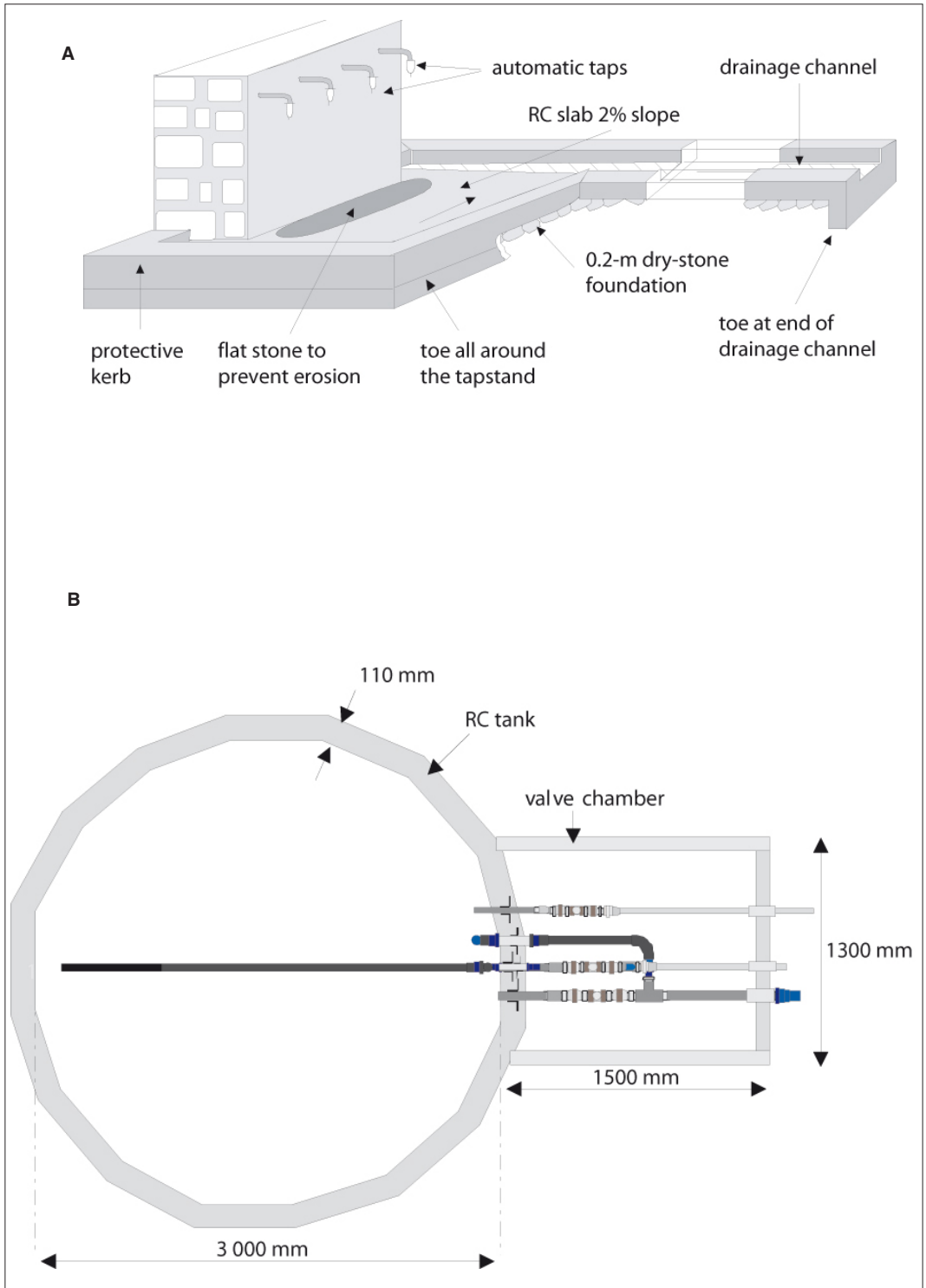
**Table 11.XXVIII: Average cost (in euros) of materials and equipment purchased in France in 1997.**

<i>Piping</i>					
GI (per 6 m)	PVC, NP 10 (per m)		HDPE, NP10 (per m)		
3/4"	18.3 €	32 mm	0.5 €	32 mm	1.5 €
1"	25.2 €	40 mm	0.8 €	40 mm	2.3 €
2"	50.3 €	50 mm	1.2 €	50 mm	3.4 €
3"	86.9 €	75 mm	2.4 €	75 mm	7.6 €
		90 mm	3.2 €	90 mm	10.7 €
		110 mm	4.6 €		
<i>Fittings</i>					
GI	PVC		PE		
2" socket	7.6 €	2" socket	2.0 €	2" socket	13.0 €
2" nipple	4.6 €	2" union	6.9 €	2" union	15.2 €
2" union	14.5 €	90° 2" elbow	3.4 €	90° 2" elbow	17.5 €
90° 2" elbow	5.9 €	90° 2" tee	4.0 €	90° 2" tee	19.1 €
90° 2" tee	8.8 €	2-1" reducing socket	2.1 €	2-1" reducing socket	13.0 €
2-1" reducing socket	6.4 €				
<i>Miscellaneous</i>					
Tapping saddle clamp 50			15.2 €		
Repair clamp (100 mm)			7.6 €		
Repair clamp (200 mm)			61 €		
High tolerance connection DN 40 to 300			25.9 to 99.1 €		
<i>Equipment</i>					
	Quantity	Price			
Diesel pump and accessories	1	1 829.3 €			
Rapid land survey kit	1	609.8 €			
Proportional dosing device (1 to 20 m <sup>3</sup> /h)	1	1 524.4 €			
Analysis kits:					
– bacteriological analysis + consumables	1	2 134.4 €			
– aluminium analysis	1	101.2 €			
Small tools and equipment	1	762.2 €			
Aluminium sulphate (50 kg)	10	762.2 €			
HTH (kg)	10	152.4 €			

### 1.3 Example of the Ban Houn system

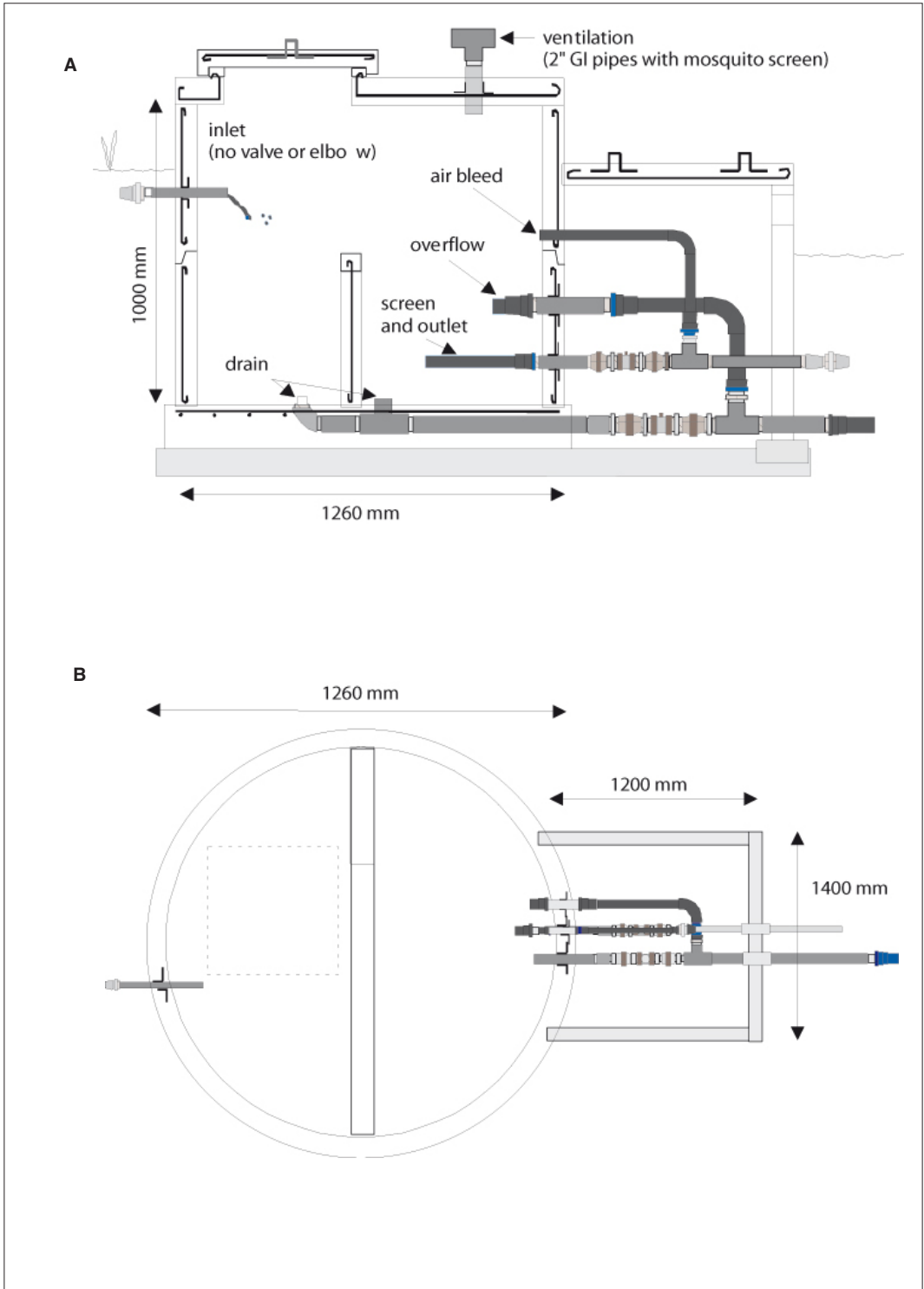
The following example shows a gravity distribution system from a spring catchment in Laos, for the village of Ban Houn (ACF, 1998). Figures 11.35 and 11.36 show plans for the tanks built for this system (Box 1).

When villages are inaccessible, especially for the transport of materials such as cement and reinforcing steel, it is possible to use pre-fabricated polyethylene tanks. They can be buried and protected by a fenced-off area on the surface (Figure 11.37).

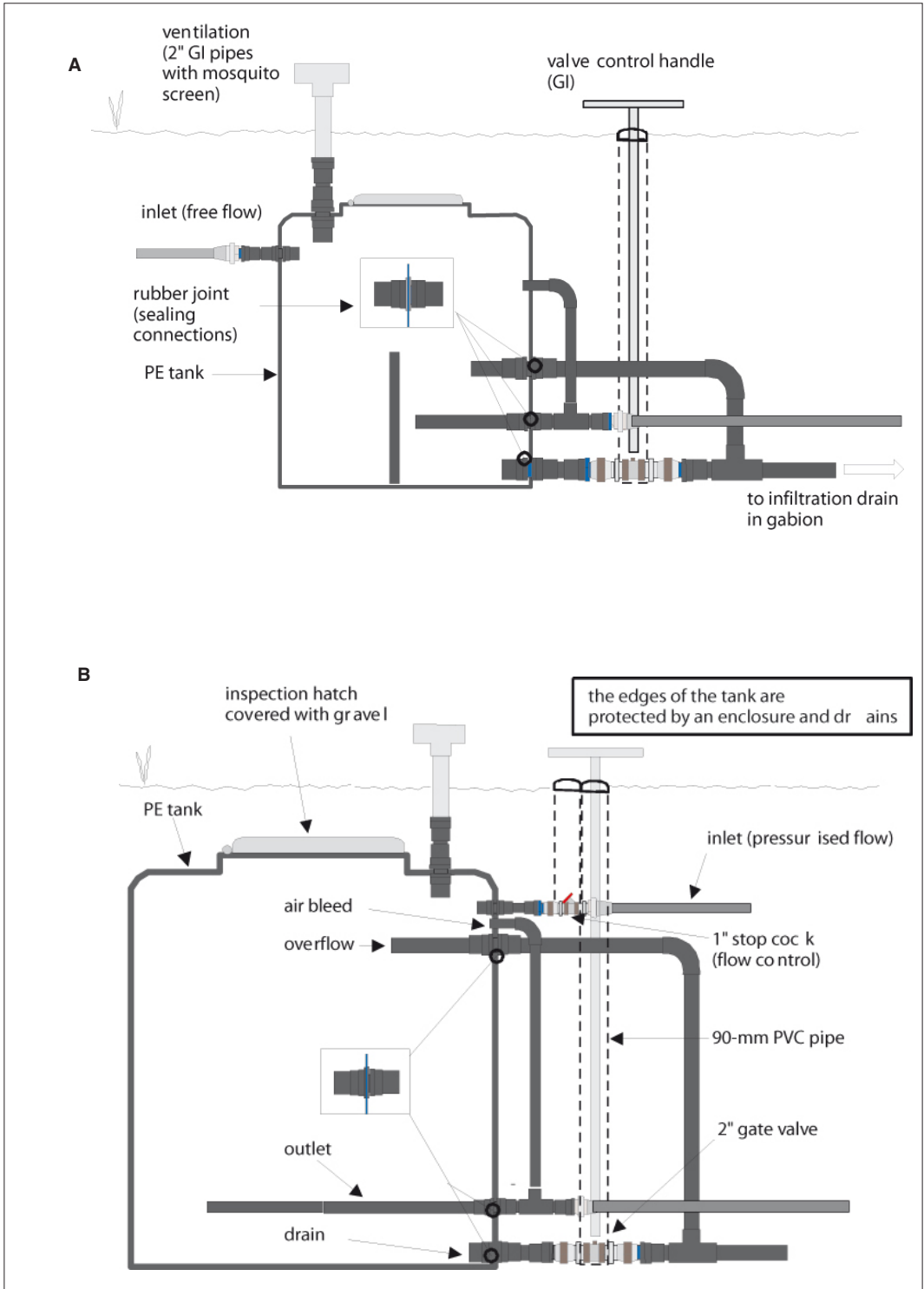


**Figure 11.35: Reinforced concrete tank (ACF, Laos, 1998).**

**A:** section. **B:** plan.



**Figure 11.36: Header tank.**  
**A: section. B: plan.**



**Figure 11.37: Polyethylene tank.**  
**A: header. B: tank.**

## Box 11.2

### Design of the Ban Houn system.

Site: Ban Houn

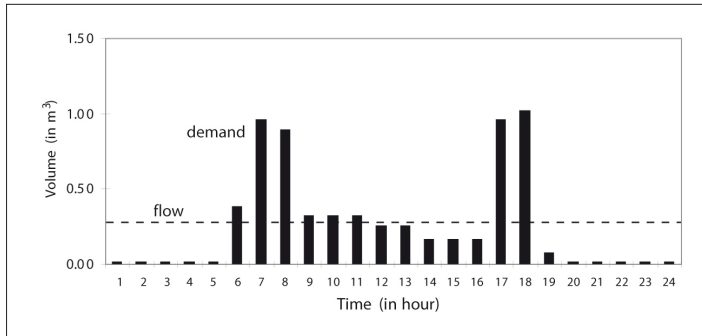
Date: 22/07/98

Population growth rate: 3%

#### Analysis of the situation

	Current population	Population in 10 years	Demand l/person/day	Daily demand (m <sup>3</sup> /day)	Number of taps
Population	123	159.9	40	6.396	2
Health centre		0	10	0	0
Hospital		0	50	0	0
Market		0	10	0	0
Temple		0	10	0	0
School		0	0	0	0

Daily demand: 6.40 m<sup>3</sup>/day. Number of taps: 2. Spring yield (dry season): 0.075 l/s.



**Figure 1: Comparison of hourly demand and spring flow.**  
Spring flow (l/h) < hourly demand → storage is required (tank).

#### Volume of tank

Flow of spring (dry season): 0.27 m<sup>3</sup>/h. Total demand: 6.40 m<sup>3</sup>/day.

Time of day	Coefficient of consumption (%) during the period	Demand during the period (m <sup>3</sup> )	Volume of water produced by the spring during the period (m <sup>3</sup> )	Difference (m <sup>3</sup> )	Negative stock	Positive stock	Accumulated stock (m <sup>3</sup> )
1	0.2	0.01	0.27	0.26	0.00	0.26	0.26
2	0.2	0.01	0.27	0.26	0.00	0.26	0.51
3	0.2	0.01	0.27	0.26	0.00	0.26	0.77
4	0.2	0.01	0.27	0.26	0.00	0.26	1.03
5	0.2	0.01	0.27	0.26	0.00	0.26	1.29
6	6.0	0.38	0.27	-0.11	-0.11	0.00	1.17
7	15.0	0.96	0.27	-0.69	-0.69	0.00	0.48
8	14.0	0.90	0.27	-0.63	-0.63	0.00	-0.14
9	5.0	0.32	0.27	-0.05	-0.05	0.00	-0.19
10	5.0	0.32	0.27	-0.05	-0.05	0.00	-0.24
11	5.0	0.32	0.27	-0.05	-0.05	0.00	-0.29
12	4.0	0.26	0.27	0.01	0.00	0.01	-0.28
13	4.0	0.26	0.27	0.01	0.00	0.01	-0.26
14	2.6	0.17	0.27	0.10	0.00	0.10	-0.16
15	2.6	0.17	0.27	0.10	0.00	0.10	-0.06
16	2.6	0.17	0.27	0.10	0.00	0.10	0.05
17	15.0	0.96	0.27	-0.69	-0.69	0.00	-0.64
18	16.0	1.02	0.27	-0.75	-0.75	0.00	-1.40
19	1.2	0.08	0.27	0.19	0.00	0.19	-1.20
20	0.2	0.01	0.27	0.26	0.00	0.26	-0.94
21	0.2	0.01	0.27	0.26	0.00	0.26	-0.69
22	0.2	0.01	0.27	0.26	0.00	0.26	-0.43
23	0.2	0.01	0.27	0.26	0.00	0.26	-0.17
24	0.2	0.01	0.27	0.260	0.00	0.26	0.08
TOTAL	100.0	6.40	6.48	0.08	-3.02	3.10	

Minimum tank volume: 2.68 m<sup>3</sup>. Optimum tank volume): 2.77 m<sup>3</sup>. Volume selected: 3.50 m<sup>3</sup>.



*Topographic survey, Abney level*

Province: Luang Namtha

District: Nale

Site: Ban Houn

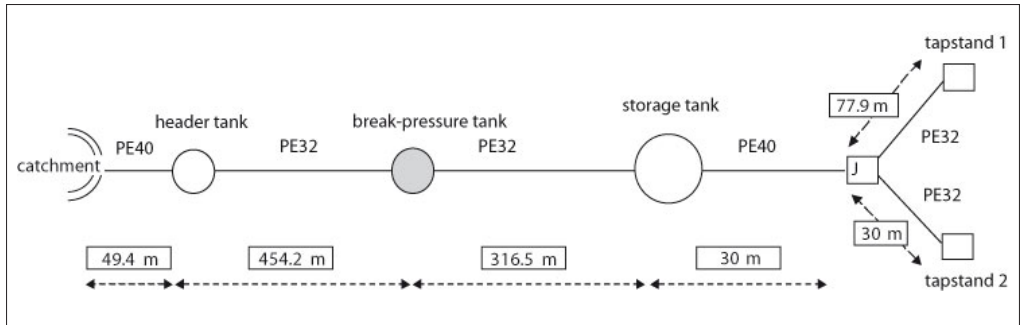
Date: 19/07/98

Station	Distance to ground (m) between stations	Distance to ground (m) cumulative	Vertical angle (decimal degrees)	Vertical angle (degrees & minutes)	Vertical distance (m)	Elevation (m)	Comments
0		0.0				626.0	Catchment
1	19.8	19.8	-6.67	-6° 40'	-2.30	623.7	
2	29.6	49.4	-6.17	-6° 10'	-3.18	620.5	Header tank (HT)
3	22.0	71.4	-8.17	-8° 10'	-3.13	617.4	
4	17.8	89.2	-7.17	-7° 10'	-2.22	615.2	
5	22.5	111.7	-7.17	-7° 10'	-2.81	612.4	
6	22.3	134.0	-7.00	-7° 00'	-2.72	609.7	
7	20.4	154.4	-0.67	-0° 40'	-0.24	609.4	
8	28.1	182.5	-3.33	-3° 20'	-1.63	607.8	
9	23.0	205.5	-2.67	-2° 40'	-1.07	606.7	
10	19.4	224.9	-1.67	-1° 40'	-0.56	606.1	
11	23.6	248.5	-3.33	-3° 20'	-1.37	604.8	
12	24.7	273.5	-13.17	-13° 10'	-5.63	599.1	
13	25.1	298.3	-19.17	-19° 10'	-8.24	590.9	
14	25.3	323.6	-19.33	-19° 20'	-8.38	582.5	
15	19.8	343.4	-20.17	-20° 10'	-6.83	575.1	
16	21.3	364.7	-18.67	-18° 40'	-6.82	568.9	
17	9.1	373.8	-15.17	-15° 10'	-2.38	566.5	
18	22.8	396.6	-8.67	-8° 40'	-3.44	563.1	
19	27.0	423.6	-18.00	-18° 00'	-8.34	554.7	
20	27.8	454.4	-19.67	-19° 40'	-9.36	545.4	
21	30.0	481.4	-10.33	-10° 20'	-5.38	540.0	
22	22.2	503.6	-8.33	-8° 20'	-3.22	536.8	Break-pressure tank (BPT)
23	22.3	525.9	-8.00	-8° 00'	-3.10	533.7	
24	20.2	546.1	-7.33	-7° 20'	-2.58	531.1	
25	25.9	572.0	-11.17	-11° 10'	-5.02	526.1	
26	22.0	594.0	-18.33	-18° 20'	-6.92	519.2	
27	29.3	623.3	-20.83	-20° 50'	-10.42	508.7	
28	28.0	651.3	-18.67	-18° 40'	-8.96	499.8	
29	17.4	668.7	-19.50	-19° 30'	-5.81	494.0	
30	17.5	686.2	-22.67	-22° 40'	-6.74	487.2	
31	24.2	710.4	-21.67	-21° 40'	-8.93	478.3	
32	20.5	730.9	-19.83	-19° 50'	-6.96	471.3	
33	21.2	752.1	-21.17	-21° 10'	-7.65	463.7	
34	30.0	782.1	-18.33	-18° 20'	-9.44	454.2	
35	30.0	812.1	-1.17	-1° 10'	-0.61	453.6	
36	8.0	820.1	-2.67	-2° 40'	-0.37	453.3	Storage tank
37	30.0	850.1	-2.67	-2° 40'	-1.40	451.9	Junction
38	30.0	880.1	-4.83	-4° 50'	-2.53	449.3	
39	6.7	886.8	-0.83	-0° 50'	-0.10	449.2	
40	30.0	916.8	-1.00	1° 00'	0.52	449.8	
41	11.2	928.0	-0.50	-0° 30'	-0.10	449.7	Tapstand 1 (T1)
42	8.0	68.0	0.00		-0.37	453.3	Storage tank
43	30.0	98.0	0.00		-4.20	449.1	
44	30.0	128.0	0.00		-3.10	446.0	Tapstand 2 (T2)

### Head-losses

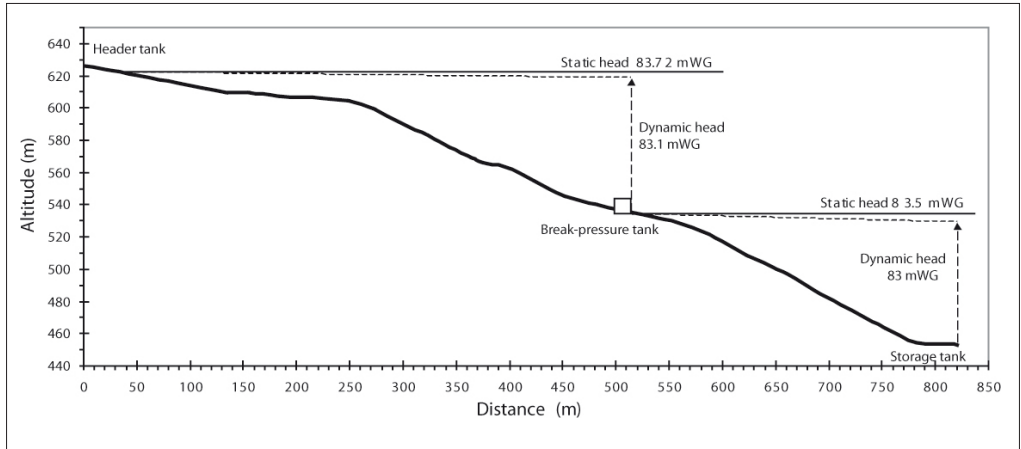
Station 1	Station 2	Flow (l/s)	Pipe length (m)	Pipe dia (mm)	Friction coefficient (%)	Speed (m/s)	Head-losses (m)	Station altitude		Drop (h1 - h2) (m)	Static head 1 (Ph1) (m)	Residual head 2 (Ph1+h-P) (m)	Comments
								1 (h1)	2 (h2)				
0	2	0.075	49.4	33/40				626.0	620.5	not under pressure			CAPT - HT
2	22	0.075	454.2	26/32	0.15	0.15	0.68	620.5	536.8	83.7	0.0	83.1	HT - BPT
22	36	0.075	316.5	26/32	0.15	0.15	0.47	536.8	453.3	83.5	0.0	83.04	BPT- STO
36	37	0.5	30.0	33/40	1.3		0.39	453.3	451.9	1.4	0.0	1.01	STO - J
37	41	0.25	77.9	26/32	1.3	0.5	1.01	451.9	449.7	2.2	1.01	2.19	J - T1
43	44	0.25	30.0	26/32	1.3	0.5	0.39	449.1	446.0	3.1	1.01	3.72	J - T2

PE 32 = 878.6 m                      PE 40 = 79.4 m                      TOTAL = 958 m



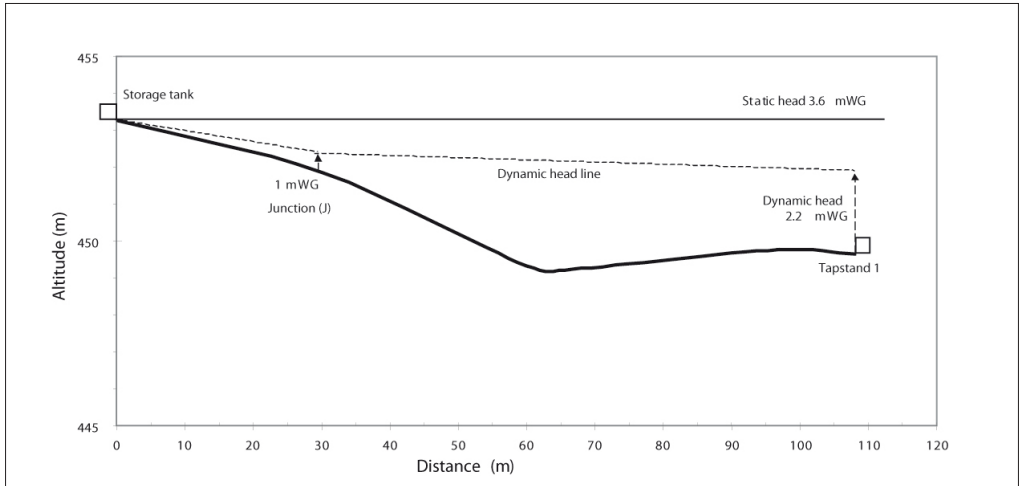
**Figure 2: The gravity system.**

### Head profile



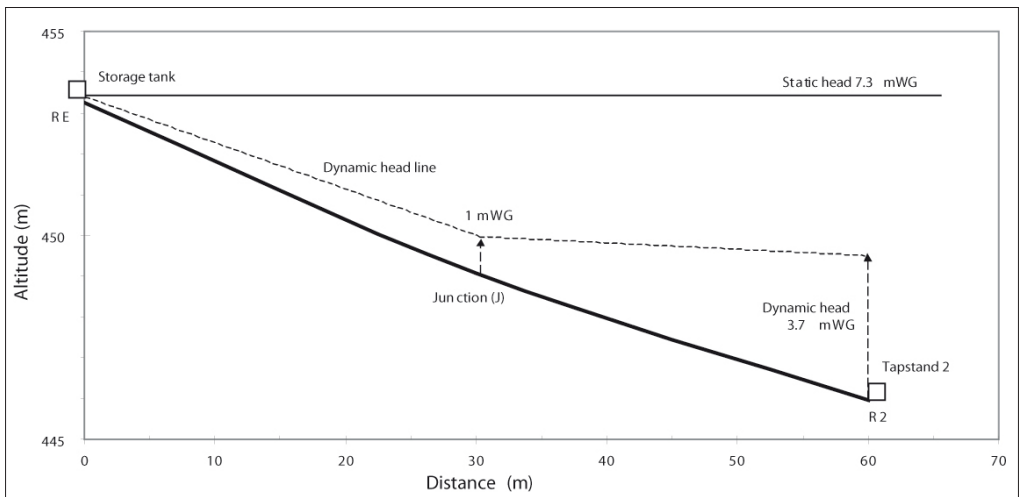
**Figure 3: Main supply line.**

	Spring	Header tank	Break-pressure tank	Storage tank
Altitude (m)	626.0	620.52	536.8	453.3
Pipe dia (mm)		33/40	26/32	26/32
Length (m)	0	49.4	503.6	820.1
Flow (l/s)		0.075	0.075	0.075
Residual head (mWG)	0	0.0	83.1	83.0



**Figure 4: Storage tank to tapstand 1.**

	Storage tank	Junction	Tapstand 1
Altitude (m)	453.3	451.9	449.7
Pipe dia (mm)		33/40	26/32
Length (m)	0	30	107.9
Flow (l/s)		0.5	0.25
Residual head (mWG)	0.0	1.0	2.2



**Figure 5: Storage tank to tapstand 2.**

	Storage tank	Junction	Tapstand 2
Altitude (m)	453.3	451.9	446.0
Pipe dia (mm)		33/40	26/32
Length (m)	0	30	60
Flow (l/s)		0.5	0.25
Residual head (mWG)	0.0	1.0	3.7

## Quantities

HT		HT/ VC		HT REINFORCEMENT	
H	1 m	H	0.9 m		
Exterior dia	1.3 m	l	0.8 m	<i>Side</i>	
Wall thickness	0.07 m	Wall thickness	0.08 m	6-mm bar	
Cover thickness	0.08 m	Cover thickness	0.08 m	Mesh H	0.12 m
Slab thickness	0.15 m	Slab thickness	0.1 m	Mesh V	0.12 m
Depth of the foundations	0.15 m	Depth of foundations	0.1 m	Bar H	17.90 m
Wall centre circumference	2.15 m			Bar V	17.90 m
External area	1.33 m <sup>2</sup>	Side-wall area	2.16 m <sup>2</sup>	<i>Cover</i>	
Internal area	1.06 m <sup>2</sup>	Exterior area	0.64 m <sup>2</sup>	6-mm bar	
External volume	1.33 m <sup>3</sup>			Mesh	0.12 m
Internal volume	1.06 m <sup>3</sup>			Bar	22.10 m
Side-wall volume	0.27 m <sup>3</sup>	Side-wall volume	0.17 m <sup>3</sup>		
Roof volume	0.11 m <sup>3</sup>	Roof volume	0.051 m <sup>3</sup>	<i>Slab</i>	
Slab volume	0.20 m <sup>3</sup>	Slab volume	0.064 m <sup>3</sup>	6-mm bar	
Internal-wall volume	0.078 m <sup>3</sup>			Mesh	0.12 m
Total 350 kg/m <sup>3</sup>	0.65 m <sup>3</sup>	Total 350 kg/m <sup>3</sup>	0.29 m <sup>3</sup>	Bar	22.10 m
Foundation volume	0.20 m <sup>3</sup>	Foundation volume	0.064 m <sup>3</sup>	<i>VC sides</i>	
Total 200 kg/m <sup>3</sup>	0.20 m <sup>3</sup>	Total 200 kg/m <sup>3</sup>	0.06 m <sup>3</sup>	6-mm bar	
				Mesh H	0.12 m
				Mesh V	0.12 m
				Bar V	18.00 m
				<i>Cover + Slab VC</i>	
				6-mm bar	
				Mesh	0.12 m
				Bar	10.70 m
Cement	269 kg	Cement	114 kg		
Total cement + losses	10%				
i.e. 420 kg	8.4 bags		9 bags		
			0.45 t		
Total reinforcement bar + losses	10%	Weight dia 6	0.21 kg		
i.e. 29.3 kg	126.8 m				
TANK				Theoretical demand (m <sup>3</sup> )	2.68
				Actual demand (m <sup>3</sup> )	3.50
				Tank W (m)	2.00
				Tank L (m)	2.00
				Demand H (m)	0.88
				Sedimentation H (m)	0.25
				Aeration H (m)	0.25
				Total H (m)	1.38
Height of tank (m)	1.38	HT			
Height of water (m)	1.13	HW			
Internal width of tank (m)	2.00	LA		Width VC	1.2 LA2
Internal length of tank (m)	2.00	LO		Length VC	1.2 LO2
Volume of tank (m <sup>3</sup> )	4.50				
Perimeter (m)	8.24				
Maximum bending moment (kg. m)					
$M_{max} = p \times H^3 / 6$	237.3047				
<i>Minimum side-wall thickness</i>					
$e = 2 \times \text{rac}2 (M_{max}/100)$	3.08			Choice	12 cm
					0.12 m
				Binding wire weight	0.025 kg/m
<i>Section of vertical bar for 1 m of side-wall</i>				<i>Section of horizontal bar for 1 m of side-wall</i>	
$A_{barV} = M_{max} / (T_{bar} \times z)$	5.33 cm <sup>2</sup>			$A_{barH} = 1/3 A_{barV}$	1.78 cm <sup>2</sup>
$z = 7/8 \times e$					
$T_{bar}$	1 650 kg/cm <sup>2</sup>				
<i>Bar V available dia 10 mm</i>				<i>Bar H available dia 8 mm</i>	
Section V	0.79 cm <sup>2</sup>			Section H	0.50 cm <sup>2</sup>
Number of bars V	7.0			Number of bars H	4.0
Mesh V	14.3 cm			Mesh H	25.0 cm
Choice	12 cm			Choice	15 cm

<b>SIDES</b>		Quantity of bar V	10 mm	Quantity of bar H	8 mm
		Length	137.50 m	Length	110 m
		Weight	81.13 kg	Weight	41.80 kg
		Binding wire	70 m		
		Weight	1.7 kg		
<b>SLAB</b>		L	W		
	Mesh	15 cm	15 cm		
	Bar dia	8 mm	8 mm		
	Length	26.67 m	26.67 m		
	Weight	10.05 kg	10.05 kg		
	Binding wire		25 m		
	Weight		0.6 kg		
<b>COVER</b>		L	W		
	Mesh	15 cm	15 cm		
	Bar dia	8 mm	8 mm		
	Length	26.67 m	26.67 m		
	Weight	10.05 kg	10.05 kg		
	Binding wire		25 m		
	Weight		0.6 kg		
<b>SLAB, VALVE CHAMBER</b>		L	W		
	Mesh	10 cm	10 cm		
	Bar dia	6 mm	6 mm		
	Length	14.4 m	14.4 m		
	Weight	3.05 kg	3.05 kg		
	Binding wire		3 m		
	Weight		0.1 kg		
<b>COVER, VALVE CHAMBER</b>		L	W		
	Mesh	10 cm	10 cm		
	Bar dia	8 mm	8 mm		
	Length	14.4 m	14.4 m		
	Weight	5.43 kg	5.43 kg		
	Binding wire		24 m		
	Weight		0.6 kg		
<b>Volume</b>		<b>Cement (kg)</b>	<b>Cement (bags)</b>	<b>Losses (%)</b>	<b>T o t a l</b>
(bags)					
1.4	Sides	490	9.8	10	11
0.7	Slab 1	236	4.7	10	6
0.7	Foundation slab	135	2.7	10	3
0.4	Cover 1	126	2.5	10	3
0.1	Slab 2	50	1.0	10	2
0.1	Foundation slab	29	0.6	10	1
0.1	Cover 2	40	0.8	10	1
			<b>Total</b>		<b>27 bags</b>
					<b>1.35 t</b>
<b>SPRING</b>					
<i>Low wall</i>					
	Length	5 m	Mesh	15 cm	
	Height	0.6 m	Bar dia	8 mm	
	Thickness	150 mm			
	Cement	350 kg/m <sup>3</sup>			
	Area	3.00 m <sup>2</sup>	Bar length	46 m	Calculated
	Volume	0.45 m <sup>3</sup>	Bar weight	18 kg	10%
	Cement	157.5 kg	Binding wire	17 m	Cement
	Sand	191 l	Binding wire weight	0.4 kg	53 kg
					57.8 kg
					1.2 kg
					1.3 kg

Total bar dia 10		138 m
losses	0.59	81 kg
	10%	89 kg
Total bar dia 8		217 m
losses	0.38	82 kg
	10%	91 kg
Total binding wire weight	0.38	3.7 kg
losses	10%	4.0 kg
Total bar dia 6		58 m
losses	0.21	12 kg
	10%	13 kg

<i>Slab</i>	Length	3 m	Mesh	15 cm
	Width	2 m	Bar dia	8 mm
	Thickness	80 mm		
	Cement	350 kg/m <sup>3</sup>		
	Area	6.00 m <sup>2</sup>	Bar length	85 m
	Volume	0.43 m <sup>3</sup>	Bar weight	34 kg
	Cement	168 kg	Binding wire	30 m
	Sand	203 l	Binding wire weight	0.8 kg
	Gravel	407 l		
	<b>TAPSTAND</b>			
<i>Slab</i>	Length	2.5 m	Mesh	10 cm
	Width	2 m	Bar dia	6 mm
	Thickness	100 mm		
	Cement	350 kg/m <sup>3</sup>		
	Area	5.00 m <sup>2</sup>	Bar length	105 m
	Volume	0.50 m <sup>3</sup>	Bar weight	24 kg
	Cement	175 kg	Binding wire	55 m
	Sand	212 l	Binding wire weight	0.4 kg
	Gravel	424 l		
	<i>Kerb</i>	Length	9 m	Mesh
Width		0.1 m	dia mm bar	6 mm
Thickness		100 mm		
cement		350 kg/m <sup>3</sup>		
Area		0.90 m <sup>2</sup>	Bar length	27 m
Volume		0.09 m <sup>3</sup>	Bar weight	6 kg
Cement		31.5 kg	Binding wire	18 m
Sand		38.12 l	Binding wire weight	0.1 kg
Gravel		76.25 l		
<i>Tap post</i>		Length	1.35 m	Mesh
	Width	0.15 m	Bar dia	6 mm
	Thickness	150 mm		
	Cement	350 kg/m <sup>3</sup>		
	Area	0.20 m <sup>2</sup>	Bar length	6 m
	Volume	0.03 m <sup>3</sup>	Bar weight	1 kg
	Cement	10.631 kg	Binding wire	4 m
	Sand	12.87 l	Binding wire weight	0.03 kg
	Gravel	25.73 l		
	<i>Valve chamber</i>	Length	2.6 m	Mesh
Width		0.5 m	Bar dia	6 mm
Thickness		80 mm		
Cement		350 kg/m <sup>3</sup>		
Area		1.30 m <sup>2</sup>	Bar length	29 m
Volume		0.10 m <sup>3</sup>	Bar weight	7 kg
Cement		36.40 kg	Binding wire	16 m
Sand		44.05 l	Binding wire weight	0.11 kg
Gravel		88.11 l		
<i>Slab base</i>		Length	2.7 m	Mesh
	Width	2.2 m	Bar dia	6 mm
	Thickness	100 mm		
	Cement	200 kg/m <sup>3</sup>		
	Area	5.94 m <sup>2</sup>	Bar length	124 m
	Volume	0.59 m <sup>3</sup>	Bar weight	28 kg
	Cement	118.80 kg	Binding wire	64 m
	Sand	274.46 l	Binding wire weight	0.45 kg
	Gravel	548.92 l		

Total for a tapstand	
Cement	0.372 t
Cement	8 bags
6-mm bar	145 m
6-mm bar	30.5 kg
Binding wire	0.5 kg

Summary of materials and cost of gravity distribution system

Site: Ban Houn

Date: 22<sup>nd</sup> July 1998

Material and fittings	U	Unit cost (US\$)	System components					Total required	Total cost (US\$)	
			Spring	HT	BPT	Pipeline	Storage tank			
<b>REINFORCEMENT</b>										
Bar dia10	kg	0.65	11				115	126	81.90	
Bar dia 6	kg	0.65		25	20		5	35	85	55.25
Bar dia 8	kg	0.65	8				55		63	40.95
1 mm binding wire	kg	1.89						10	10	18.90
<b>CONSTRUCTION</b>										
Bricks	each	0.04					400	400	16.00	
Cement	t	95	0.3	000	000		001	0.6	003	251.75
Bar dia 8	kg	0.5						4	4	2.00
Bar dia 6	kg	0.5						2	2	1.00
Cement additive	kg							10	10	
<b>VALVES</b>										
1/2" ball valve	each	8.82						0	0	128.58
3/4" Talbot tap	each	16						2	2	32.00
3/4" stop cock	each	44						2	2	88.00
1" adjustable stop cock	each	39			1				1	39.00
1" 1/2 stop cock	each	14.29		1	1		1		3	42.87
Joint for valves	each	1						20	20	20.00
<b>PVC</b>										
1" 1/2 socket	each	0.26					1	1	0.26	
1" 1/2 F adaptor	each	2	1	1	1		1	4	8.00	
2" F adaptor	each	6	3	2	2		1	8	48.00	
2" M adaptor	each	0.43		2	2		1	5	2.15	
90° 2" elbow	each	4.76	2	1	1			4	19.04	
1" 1/2 PVC pipe	m	0.63	1.5	1.5	1.5		2.0	6.5	4.10	
2" PVC pipe	m	1	12.0	16.0	16.0		12.0	56.0	56.00	
PVC Glue	Tin							1	1	
<b>HDPE</b>										
90° 32 x 32 x 32 tee	each	4.9				1		1	4.90	
32 x 32 compression connection	each	2.84				9		9	25.56	
40 x 32 reducer	each	4.29				1		1	4.29	
HDPE pipe DN 32 NP 10	m	0.36				920		920	331.20	
HDPE pipe DN 40 NP 10	m	0.56				80		80	44.80	
32 x 1" female adapter	each	1.72					1	1	1.72	
32 x 1" male adapter	each	1.7		1	2			2	5	8.50
40 x 1" 1/2 male adapter	each	3	1	1				2	6.00	
<b>G.I.</b>										
G.I. 3/4" elbow	each	0.33		1	1		3	12	17	5.61
G.I. 1" elbow	each	1.2			2		2	4	4.80	
G.I. 1" 1/2 elbow	each	2.4		2				2	4.80	
G.I. 2" elbow	each	1.79		1	1		3	5	8.95	
G.I. 3/4" nipple	each	0.6						8	8	4.80
G.I. 1" nipple	each	0.8			4		4	8	6.40	
G.I. 1" 1/2 nipple	each	1.5		3	3		3	9	13.50	
G.I. 2" nipple	each	2.2		3	3		3	9	19.80	
G.I. 3/4" pipe	m	1.92		1.0	1.0		3.5	6.0	11.5	22.08
G.I. 1" pipe	m	2.72			1.0		2.0	3.0	8.16	
G.I. 1" 1/2 pipe	m	3.76	0.5	1.5	0.5		0.5	3.0	11.28	
G.I. 2" pipe	m	4.7	1.0	2.0	2.0		3.5	8.5	39.95	
G.I. 1"-3/4" F-F reducer	each	0.85						2	2	1.70
G.I. 1" 1/2-3/4" M-F reducer	each	1.28		1	1		1	3	3.84	
G.I. 1" 1/2 socket	each	2.15	1					1	2.15	
G.I. 1" 1/2 tee	each	3.24		1	1		1	3	9.72	
G.I. 2" tee	each	4.72		2	1		1	4	18.88	
G.I. 3/4" union	each	2					1	4	5	10.00
G.I. 1" union	each	3.22			2		1	3	9.66	
G.I. 1" 1/2 union	each	3.96		2	2		2	6	23.76	
G.I. 2" union	each	6.8		2	2		2	6	40.80	
<b>TOTAL COST</b>									1 653.36	

## 2 Emergency distribution systems from boreholes

### 2.1 Implementation

On productive boreholes, with an exploitation flow of several m<sup>3</sup>/h, and in certain contexts (emergency situations, densely populated or urban areas etc.), a submersible pump may be installed to supply a series of tapstands, instead of using several boreholes equipped with handpumps. Implementation is quicker, and management of one motorised system is simpler than regular maintenance of a series of handpumps. Also, a simple system of water chlorination can be installed at the distribution tank. This is much simpler and more flexible than a treatment system at every handpump or in every house, and is particularly important in regions where cholera is endemic and risks of epidemics are high. Finally, if a management system is established, these mini-systems, often installed under emergency conditions, can be kept and improved to supply an area which is insufficiently supplied by the permanent system for the local population.

The mini-system consists of:

- a 103-113 mm or 112-125 mm borehole (or it is possible to use a 167-180 mm borehole to install a 6" submersible pump for producing large flows);
- a pumping station, equipped with a 4" submersible pump and a generator;
- a storage tank, placed at sufficient height to supply the system by gravity;
- a system for disinfecting the water using chlorine (HTH);
- primary and secondary water-supply lines, supplying the tapstands;
- emergency tapstands with simple installation (to minimise mud).

Obviously, the choice of submersible pump depends on the flow and head required (see Chapter 6), but it is possible to use a submersible pump with standard equipment, linked to a generator if necessary. The storage tank may be temporary or permanent, depending on the context. Emergency tanks made of corrugated sheets and liners, with standard capacities of 45, 70 and 95 m<sup>3</sup>, are very quick to assemble, and are suitable for a semi-permanent installation (several years). However, they have to be mounted on the ground. Where a water tower is required, Braithwaite-type tanks consisting of galvanised steel panels, which can be permanently mounted on top of a metal tower, are preferable. The dimensions and volumes of tanks offered by this supplier range from several dozens to several hundreds of cubic metres.

For simplicity, 2" piping is regarded as standard for small-scale emergency installations (installation of emergency tapstands, pump outlet, standard connections). In more complex systems, which may continue working over several years, it is essential to design the whole system correctly (see Chapter 11A). The pipes are buried, except in extreme emergencies where this is done in a second phase.

The system of water chlorination is either a Dosatron-type dosing pump proportional to the flow, or a simple drip-feed system installed in the tank. (Note: chlorine is consumed by the metal in metallic tanks, see Chapter 12.)

### 2.2 Human and financial resources

A list of the personnel necessary for the implementation of an emergency mini-system from a borehole is shown in Table 11.XIX.

The cost of a mini-system from a borehole (excluding the borehole itself) supplying two water supply lines of 250 m, and 6 tapstands with 4 taps each, providing the daily supply for 3 200 people is shown in Table 11.XX. The storage tank is a 24 m<sup>3</sup> Braithwaite tank.

Water is distributed in two periods of 2 h/day, one in the morning and the other in the afternoon. The flow per tap is fixed between 0.15 and 0.2 l/s. The tank is refilled in 4 h, during the evening for the following morning, and from 11:00 to 15:00 for the afternoon distribution.



**Table 11.XIX: Personnel required for the installation of an emergency mini-system on a borehole.**

Team	Indicative monthly salary (US\$)
1 electrician (installing and repairing pumps)	150-200
1 site foreman	150-200
1 person responsible for the station (chosen from within the community)	40-60
2 plumbers (for the duration of the work)	100-150
12 labourers (for the duration of the work)	40-80
2 masons (for the duration of the work)	100-150
1 driver	60-80

**Table 11.XX: Cost of a mini-system on a borehole producing 6 m<sup>3</sup>/h, which provides 48 m<sup>3</sup>/day and covers an emergency demand of 15 l/person/day.**

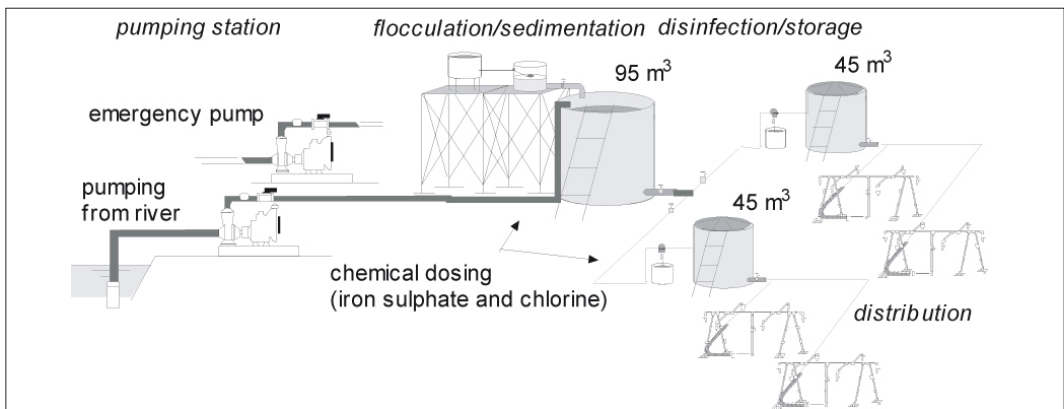
	Unit cost (€)	Quantities	Total cost (€)
Pumping kit	5 000	1	5 000
24 m <sup>3</sup> Braithwaite storage tank	5 000	1	5 000
Tapstands	270	6	1 620
Dosatron dosing system	1 100	1	1 100
2" water-supply line (m)	6	500	3 000
Distribution accessories kit	2	1 500	3 000
HTH stock (kg)	4	100	400
Bacteriological analysis kit	2 500	1	2 500
<b>TOTAL</b>			<b>21 620</b>

### 3 Emergency systems from rivers

#### 3.1 Implementation

These emergency water-supply systems involve production and treatment stations using a surface-water source (lake or river). The water is distributed over a branched system via emergency tapstands.

The water-treatment system uses simple technology, and generally consists of flocculation-sedimentation followed by chlorine-based disinfection (Figure 11.38).



**Figure 11.38: General plan of an emergency water-supply system.**

### 3.1.1 PUMPING

Water is pumped directly from the river with a surface motorised pump (simple and cheap), or with a submersible electric dewatering pump. The pump strainer is kept at 1 m below the water surface by a float, or is installed in a pumping well (see Chapter 12). The water intake is located as far upstream as possible in relation to inhabited areas, and given maximum protection from faecal pollution.

### 3.1.2 FLOCCULATION-SEDIMENTATION

This operation (see Chapter 12) is carried out in the standard manner in rigid tanks, by injecting a flocculant such as aluminium sulphate. Determining the correct dose requires the preparation of a mother solution at 5% and some calibration (jar test) depending on the turbidity of the untreated water.

### 3.1.3 DISINFECTION AND STORAGE

Once sedimented, the water goes to a tank, where it is disinfected and stored before being distributed via a gravity system.

The tanks used (Oxfam type – see Section 3.1.5) consist of an assembly of corrugated sheets screwed together, with a rubber lining inside. The disinfection-storage tanks must be covered.

The volumes generally used are 45, 70 and 95 m<sup>3</sup>.

### 3.1.4 MOBILE TREATMENT UNIT

The system consists of a 95 m<sup>3</sup> flocculation/sedimentation tank, plus two 45 m<sup>3</sup> tanks for chlorination and storage, for a daily production of 80 or 160 m<sup>3</sup> with two sedimentation cycles. The exact measurement of decantation time enables the number of daily refill-distribution cycles to be determined (test of preliminary decantation time – see Chapter 12). To increase the volume of water treated, simply add one or more modules (a sedimentation tank and two storage tanks) to the treatment chain.

### 3.1.5 CONSTRUCTING AN OXFAM-TYPE RIGID TANK

These tanks have a range of capacities (Table 11.XXI). The example given involves the installation of an Even-Products 45 m<sup>3</sup> tank, the construction time for which is half a day with a team of six people (Table 11.XXII).

### 3.1.6 FILTRATION-FLOCCULATION

Filters working under pressure are used, with a 40 micron pore-size, composed of active carbon and a filter medium (gravel, fine sand etc.). The pumped water goes directly under pressure through the filters after the injection of a flocculant, the principle being to trap the flocs in the filters\*. The necessary contact time for coagulation occurs in the pipes.

**Table 11.XXI: Characteristics of OXFAM-type rigid tanks**

Capacity (l)	Height (m)	Number of rows of sheets	Diameter (m)
11,000	2.3	2	2.5
45,000	1.5	2	6.4
70,000	2.3	3	6.4
95,000	3.0	4	6.4

\* Experiments and studies under development.

**Table 11.XXII: Installation of an Even-Products 45 m<sup>3</sup> tank.**

---

Clearing site of soil and all coarse particles
Marking 2 concentric circles (radiuses of 3.2 and 3.5 m)
Digging a channel of 5 cm of depth between these circles
Laying the tank in the centre of the circles
Assembling the first row of sheets and sitting them in the channel
Consolidation of the base (interior and exterior) with soil or sand
Mounting the second row of sheets
Applying the protection tape and the PVC capping
Installing the tank liner (the bottom of the tank is the bare ground)
Fixing the liner to the top of the second layer of sheets with clips
Cutting a hole in the liner at the outlet hole, and fitting the flanges
Installing the central pole and supporting ropes connecting this pole to the tank sides
Fitting the tank roof, held tight with elastic strainers

---

The greatest disadvantage of this treatment system is the rapid blocking of the filters when the water is too turbid (> 100 NTU). It is then necessary to carry out frequent back-washings, which consume a great of water: the flow falls radically from 10 to 5 m<sup>3</sup>/h.

One solution consists of locating this filter downstream of a standard in-tank flocculation-sedimentation system (e.g. Bô, ACF Sierra Leone, 1996). The variations in the turbidity of the water leaving the sedimentation tank can therefore be prevented, and the 'residual flocs' can be trapped in the filter.

This system is particularly useful in the case of poor flocculation/sedimentation resulting from sudden variations in the turbidity of the raw water (following storms etc.), and also to shorten the duration of the water treatment allowing two sedimentation cycles per day, thus doubling the production of treated water.

## 3.2 Example of the Aswha system

Aswha is located in Southern Sudan, some 40 km from the border with Uganda: a system was installed there in 1993 to provide water for a camp of 5 000 displaced people (Figure 11.38).

### 3.2.1 PUMPING STATION AND DISTRIBUTION SYSTEM

Situated on the banks of the Ashwa river, the pumping station has an Atlanta pump driven by a 2-cylinder Lister-Petter diesel engine. Daily fuel consumption is 15 l for 4 h pumping. The suction head is 2 to 7 m depending on the level of the river. The 15-m suction pipe has a pump strainer and a foot-valve. The buried delivery pipe has a total length of 700 m and consists of 3" PVC pipes, with push-fit joints.

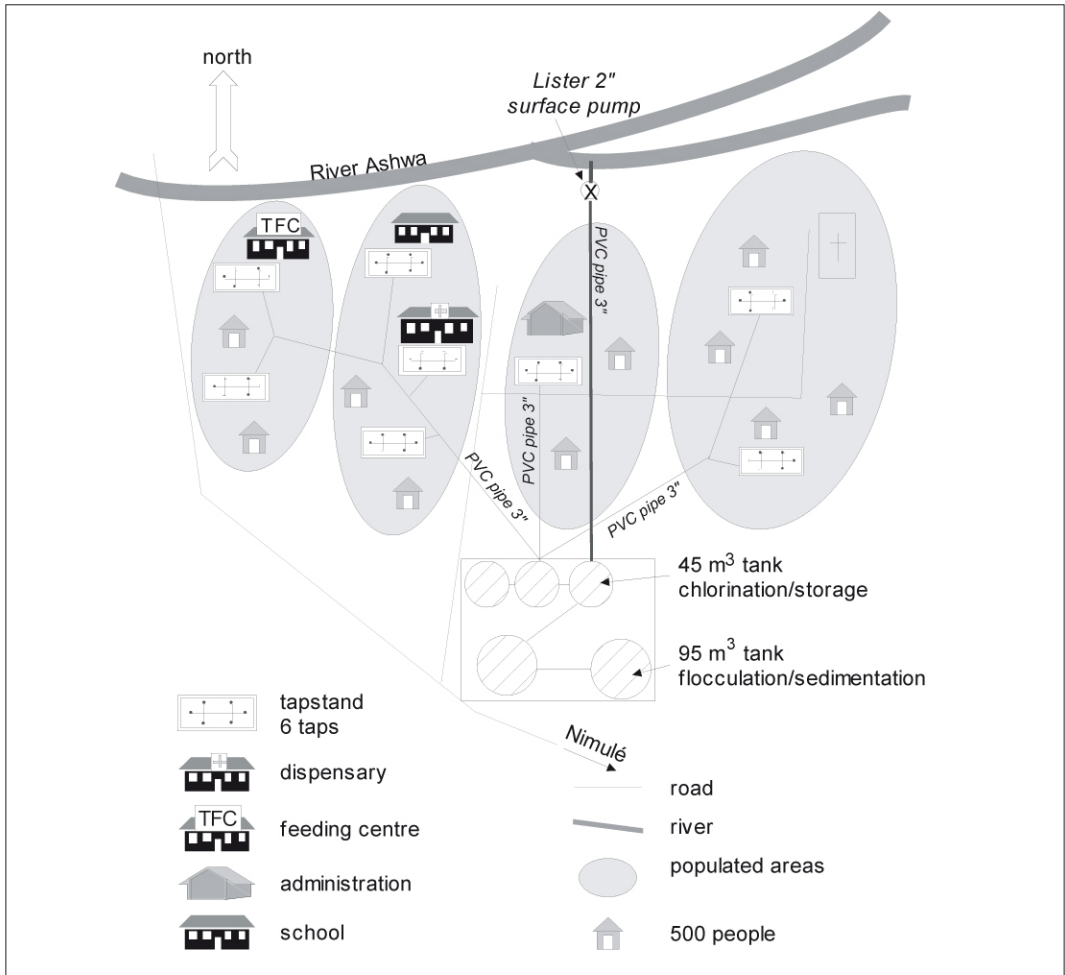
The total difference in height between the pump and the treatment station (Table 11.XXIII) is 35 m. Residual pressure in the pipe is 20 mWG. Flow is 30 m<sup>3</sup>/h. Head-losses are estimated at 25 mWG.

**Table 11.XXIII: Treatment unit.**

---

Two 95 m <sup>3</sup> tanks for sedimentation
Three 45 m <sup>3</sup> tanks for chlorination-storage
Foundations of the tanks: 30 cm stone base and concrete slab

---



**Figure 11.39: Emergency water supply system installed at Ashwa (Southern Sudan, 1993).**

### 3.2.2 OPERATION

Daily production is 120 m<sup>3</sup> of treated water. Tanks are refilled in a single four-hour pumping operation in the afternoon.

The flocculation additive is mixed during the simultaneous refilling of the two 95 m<sup>3</sup> tanks. After a night of sedimentation, the tanks are then emptied into the chlorination-storage tanks (duration: 3 h). Chlorine solution is added to the first tank in the morning. The treated water is then distributed throughout the gravity system in the afternoon.

**Table 11.XXIV: Consumables.**

Aluminium sulphate	8 kg/day
Calcium hydroxide [Ca(OH) <sub>2</sub> ]	3 kg/day
HTH at 65 %	360 g/day
Phenol red (for checking pH )	12 tablets/week
DPD 1 (free residual chlorine)	12 tablets/week

**Table 11.XXV: Treatment results.**  
**T= storage tank.**

Parameters	Before treatment	After treatment	In the system
Turbidity (NTU)	80	< 5	
pH	7.8	6.8	7
Residual free chlorine (mg/l)	0	T1: 0.6 – T3: 0.3	0.25
Number of faecal coliforms/100 ml	> 50		0
Average flow per tap (l/s)			0.2

Consumption of treatment products is shown in Table 11.XXIV, and the treatment results in Table 11.XXV.

### 3.2.3 HUMAN RESOURCES AND STATION MANAGEMENT

Daily planning of the various treatment phases (refill-flocculation-sedimentation-disinfection) and distribution times is carried out by the station personnel (Table 11.XXVI). Daily updated registers record the volume of water treated, the doses of chemicals, depending on turbidity, free residual chlorine and pH before and after flocculation, and the aluminium levels after treatment. Regular bacteriological analyses are used to check water quality before and after treatment.

**Table 11.XXVI: Personnel required for a pumping station.**

1 head of station, in charge of chemical dosing, analysis and good operations
1 technician, in charge of the maintenance of pumps and equipment
2 unskilled labourers
Guards (day and night)

### 3.2.4 EQUIPMENT COSTS

The financial resources required for a system such as the one at Ashwa are shown in Table 11.XXVII.

**Table 11.XXVII: Cost (€) of the equipment needed for an Ashwa-type coagulation/flocculation treatment module.**

	Unit cost	Quantities	Total cost (€)
Diesel pump (30 m <sup>3</sup> /h at 45 m)	2 500	1	2 500
95 m <sup>3</sup> rigid tank (sedimentation, without roof)	5 350	1	5 350
45 m <sup>3</sup> rigid tank (chlorination and storage, with roof)	4 300	3	12 900
Tapstands	270	8	2 160
Dosing system, dosing pump	1 100	1	1 100
3" PVC water supply line (m) with fittings	6	700	4 200
3" PVC distribution line (m) with fittings	6	1 500	9 000
Chlorine powder (kg)	4	500	2 000
Aluminium sulphate(kg)	1	250	250
Bacteriological analysis kit	2 000	1	2 000
<b>TOTAL</b>			<b>41 460</b>



# Water treatment

<b>1</b>	<b>Treatment procedures</b>	441	<i>1.3.3</i>	<i>Water analysis</i>	444
1.1	Choice of procedures	441	1.4	Disinfection	446
1.1.1	<i>Treatment options</i>	441	1.4.1	<i>Principles of chlorination</i>	446
1.1.2	<i>Rapid analysis</i>	442	1.4.2	<i>Implementation</i>	447
1.2	Pre-treatment	442	1.4.2.1	Preparation of the stock solution	447
1.2.1	<i>Pumping intakes</i>	442	1.4.2.2	Dose required (jar test)	448
1.2.2	<i>Storage and plain sedimentation</i>	443	1.4.2.3	Chlorination in the tank	449
1.3	Flocculation and sedimentation	443	1.4.3	<i>Measurement of free residual chlorine</i>	449
1.3.1	<i>Principle</i>	443	1.5	Filtration	450
1.3.2	<i>Implementation</i>	444	1.5.1	<i>Ceramic-candle filtration</i>	450
1.3.2.1	Preparation of the stock solution	444	1.5.2	<i>Rapid sand filters</i>	450
1.3.2.2	Estimating coagulant dose (jar test)	444	1.5.3	<i>Slow sand filters</i>	451
1.3.2.3	Flocculation in the water tank	444	1.6	Aeration	451
			<b>2</b>	<b>Chemical dosing</b>	453

In humanitarian programmes, the main objective of water treatment is to protect consumers from pathogenic micro-organisms and unpleasant-tasting impurities. Problems with toxic substances are much less frequent than microbiological problems, and are not covered in this book.

Water treatment requires equipment, skills, regular surveillance and maintenance. The smallest weakness in the treatment procedure can endanger the safety of the water supplied and the process must be closely controlled if this represents a major risk on health. This is why the alternative of home water treatment alone must be very carefully assessed as it is more difficult to monitor than collective water treatment.

## 1 Treatment procedures

### 1.1 Choice of procedures

#### 1.1.1 TREATMENT OPTIONS

A treatment procedure is a specific technique which allows a particular characteristic of the water to be corrected. The choice of procedure or combination of procedures is therefore made depending on the parameters to be treated (Table 12.I).

**Table 12.I: Water treatment procedures.**

Turbidity	→	storage/sedimentation – flocculation/sedimentation – simple filtration
Faecal pollution	→	disinfection – slow sand filtration
Iron, manganese	→	aeration then sedimentation or simple filtration

### 1.1.2 RAPID ANALYSIS

Quick analysis of untreated water allow parameters to be corrected, and an estimation of the necessary quantities of reagents to be made. Once the treatment process is started, a check on the quality of the raw water (before treatment) allows the change in water characteristics to be measured, and the treatment to be adjusted accordingly. This is particularly useful for surface-water treatment stations installed during an emergency. Water-quality parameters are given in Chapter 4.

The level of general pollution of the water to be treated (organic matter, oxidisable matter, micro-organisms etc.) can be quickly estimated by the chlorine demand (See 2.4.1). Water without any oxidisable matter has no chlorine demand, whereas polluted surface water can have a chlorine demand of up to 8 mg/l. This parameter, which is not very accurate, must be used essentially for monitoring the quality of untreated water over time. In the field, the chlorine demand is measured following the same procedure as for free residual chlorine (see Section 2.4.3).

Bacteriological analysis of the water gives a partial picture of the level of faecal pollution (see Chapter 4), and generally confirms the need for disinfection. This analysis is also used routinely to monitor the effectiveness of treatment procedures.

Turbidity results from the presence of particles in suspension in the water (organic debris, clay, microscopic organisms etc.). Strong turbidity protects the micro-organisms fixed on the particles from the disinfectant: turbidity must therefore be as low as possible to permit thorough disinfection (Table 12.II).

**Table 12.II: Scale of turbidity values.**

---

NTU < 5	Colourless water, which can be directly disinfected or filtered
5 < NTU < 30	Slightly turbid water, which requires some treatment (flocculation, sedimentation, filtration) before disinfection
NTU > 50	Turbid water, which requires some treatment (flocculation, sedimentation, filtration) before disinfection

---

The pH must be between 6 and 7.5 (Degrémont, 1989) for effective application of the coagulant aluminium sulphate. If this is not the case, it is necessary either to correct the pH, or to use a different coagulant (such as iron salts).

## 1.2 Pre-treatment

When water has to be treated, it is essential to remove suspended matter. Some simple techniques help to eliminate debris and large particles (vegetable debris, floating wood, sand) from surface water.

### 1.2.1 PUMPING INTAKES

In the case of surface-water pumping, it is essential to position the suction pipe correctly. There are several ways in which this may be done.

The use of a suitable strainer or screen, with a mesh between 5 and 20 mm, removes the largest floating or suspended particles. This mesh size, which depends on the size of the particles to be removed, must allow an entry rate of water into the strainer of less than 70 cm/s, to avoid excessive head-losses. The strainer must be located in the middle of the water with a floating device (steel drum, buoy or raft).

A filter trench (or infiltration gallery), dug in the stream alluvial deposits and filled with round stones of 10-20 cm of diameter, is an effective pre-filter technique. The pump strainer is installed in a well, made from a concrete ring or steel drum, located at the end of the trench. All or part of the filter trench and well may be built in the river or lake bed itself, or on the bank.



It is also possible to place a coarse PVC screen in the trench, with a filter layer packed around it, composed of 30 or 40 cm of pebbles 10 to 20 cm in diameter. The PVC screen is then directly connected to the pump suction end. This has the advantage, compared with the simple filter trench, of being able to be cleaned by backwashing with the pump.

## 1.2.2 STORAGE AND PLAIN SEDIMENTATION

This technique removes suspended matter and some pathogenic organisms. In fact, water is an environment in which the lifetime of these organisms is limited: according to WHO, a reduction of about 99% of faecal-indicator bacteria is reached after 3 to 4 weeks of storage. Nevertheless, the usual storage time is not long enough to remove all of them. During this storage time, sedimentation of larger pathogenic organisms also occurs, and they settle at the bottom of the reservoir.

Not all suspended materials settle easily, especially those that colour the water (colloids). It is therefore necessary to carry out a settling test in a jar: if after 1 hour most suspended matter has not settled, another technique, flocculation, must be used.

## 1.3 Flocculation and sedimentation

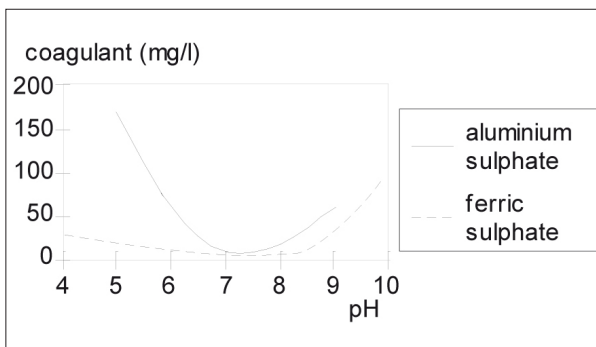
### 1.3.1 PRINCIPLE

Flocculation reduces the turbidity of the water by removing suspended matter, including colloids (especially clays and water-colouring matter) which are kept in suspension by electrostatic and hydration phenomena and are difficult or impossible to remove by plain sedimentation. Flocculation indirectly reduces the number of pathogenic organisms present in the water by settling them with the colloidal matter.

Flocculation consists of adding chemical products known as coagulants to the water. These neutralise colloids and encourage them to combine to form flocs, sufficiently large and free enough to be removed by sedimentation or filtration. The sediments, which contain the residues of coagulants and pathogenic organisms, are removed under standard hygienic conditions.

The most widely used coagulant, aluminium sulphate,  $\text{Al}_2(\text{SO}_4)_3 \cdot n\text{H}_2\text{O}$ , comes in the form of a powder or solid lumps. The lump-form, which is very difficult to reduce to powder and relatively insoluble, should be avoided. The factor limiting usage of aluminium sulphate is the pH of the water, which must be between 6 and 7.5 (Figure 12.1): if the pH is outside this range, flocculation may be poor and the quantities to be used very large. In this case, it is advisable to use another coagulant, such as ferric sulphate,  $\text{Fe}_2(\text{SO}_4)_3$ , which is active over a larger pH range (5 - 9).

Synthetic coagulants are more versatile and effective. Most are in liquid form, which can complicate their transport. Finally, there are also natural coagulants (plant seeds, fruit etc.) which may be appropriate at household level.



**Figure 12.1: Quantity of coagulant to be used as a function of raw-water pH.**

### 1.3.2 IMPLEMENTATION

Coagulants are not used directly, but in the form of a stock solution. The optimum dose required depends on the quality of the water to be treated, and must be determined by a jar test (see Section 1.3.2.2). To carry out coagulation on site, several steps are necessary.

#### 1.3.2.1 Preparation of the stock solution

This 5% solution allows the coagulant to be used conveniently. It can be stored in a 20-l jerry can (or a 200-l barrel if large amounts are needed). Stir the solution thoroughly before each use.

The stock solution can be kept for 1 week.

#### 1.3.2.2 Estimating coagulant dose (jar test)

It is not necessary to carry out this test every day if the quality of the water does not fluctuate rapidly. The test is carried out as follows:

– fill four plastic buckets with 10 l each of the water to be treated. With a syringe, add increasing doses of 5% stock solution to the buckets, so as to cover the usual dose range of 20 to 150 mg/l, for example:

- bucket 1: 4 ml of 5% stock solution, i.e. 200 mg of coagulant in 10 l of water, i.e. a coagulant (commercial product) concentration of 20 mg/l;
- bucket 2: 10 ml stock solution, i.e. coagulant concentration 50 mg/l;
- bucket 3: 20 ml stock solution, i.e. coagulant concentration 100 mg/l;
- bucket 4: 30 ml stock solution, i.e. coagulant concentration 150 mg/l.

– stir vigorously for 30 seconds, and then gently for 5 minutes;

– leave for 1 hour and then examine the samples visually: a floc looks like a piece of cotton wool soaked in water.

The smallest dose which gives good results is the recommended one. If the dose is too small, flocs do not form, are too small, or do not settle. If it is too high, traces of coagulant, which are difficult to remove, may remain in the water (especially aluminium).

#### 1.3.2.3 Flocculation in the water tank

The formation of flocs is relatively quick, so much so that the coagulant stock solution must be mixed as quickly as possible in the water to be treated. Two methods of introducing the solution ensure quick and homogenous mixing (see Section 3): introduction into the pump suction pipe, or when filling the tank.

Floc formation and sedimentation can be improved by slow and regular stirring just after the rapid mixing. In circular tanks, placing the pump discharge pipe against the side of the reservoir imparts a circular movement to the water, which facilitates mixing. The time necessary for thorough sedimentation varies from half an hour to half a day, and can only be accurately determined by tests.

It is essential to transfer the treated water to a new reservoir before chlorination in order to avoid returning settled flocs to suspension during the mixing process. Furthermore, the coagulation sediments (which are toxic because of their aluminium content) must be emptied regularly, taking care to dispose of them without contaminating water resources or farmland. Table 12.III gives some essential information about aluminium sulphate, the most widely used coagulant.

### 1.3.3 WATER ANALYSIS

The pH of water treated with a coagulant is generally lowered (Box 12.1). It is therefore necessary to verify the pH at the time of treatment and, if necessary, to modify the dosages of coagulant or to correct the pH by adding another chemical.

Aluminium must be measured in the treated water if aluminium sulphate has been used. The WHO recommend a maximum aluminium concentration of 0.2 mg/l.

**Table 12.III: Aluminium sulphate summary.**

**Characteristics**

- Content of active product in the commercial product: about 17%
- Solubility limit: 688 g/l
- Density: 1 t/m<sup>3</sup>
- Acid reagent: causes a drop of pH in the water

**Use of the commercial product**

- Stock solution at 5% → 50 g/l → 1 kg/20 l
- Usual doses: 20 to 150 mg/l of commercial product → 4 to 30 ml of stock solution per 10 l of water to be treated
- 50 kg of aluminium sulphate treats about 300 to 2 500 m<sup>3</sup> of water
- pH of the water to be treated: 6 to 7.5

**Box 12.1**

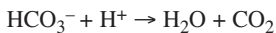
**Coagulants and pH.**

*Acidification*

Mineral coagulants (iron and aluminium salts) form a precipitate of hydroxides, creating some increase in acidity when they are dissolved in water:



This acidity can react with certain substances in solution, especially bicarbonate ions:



It can thus be compensated by the buffer capacity of the water (see Chapter 4) or, if necessary, by the addition of a base.

*Correction of pH*

Different chemicals can be used to raise the pH of the water:

(CaOH <sub>2</sub> )	Hydrated lime	not very soluble: 1.76 g/l at 10 °C
(CaO)	Quicklime	not very soluble: 1.3 g/l at 10 °C
(Na <sub>2</sub> CO <sub>3</sub> )	Soda ash	soluble: 305 g/l at 10°C

Hydrated lime is the most common product, but it is difficult to use due to its low solubility. It is necessary to prepare a solution of 1 g/l and to stir it continuously until it is used.

Measuring the alkalinity of untreated water allows the calculation of the buffer capacity of the water, and therefore the quantity of alkali to be used. Nevertheless, an approximation accurate enough for testing is given by Degrémont (1989) and obtained by compensating the acidification induced by the aluminium sulphate by the addition of:

- lime: about a third of the dose of aluminium sulphate as solid commercial product;
- soda ash: 50 to 100% of the dose of aluminium sulphate as solid commercial product.

These dosages must be verified by tests such as jar tests. If lime is used to correct the pH before flocculation, the jar test can be carried out, with a fixed dose of aluminium sulphate and different doses of lime. It is also possible to vary the dose of coagulant depending on the dose of lime, in order to determine the best proportions.

## 1.4 Disinfection

There are several methods of disinfecting water, but the most widely used in emergency programmes is chlorination. It destroys pathogenic organisms present in the water\* by blocking their enzymatic activity, and protects the water against recontamination during transport and storage. This residual disinfectant effect is its main advantage over treatment by ozone or ultraviolet rays.

### 1.4.1 PRINCIPLES OF CHLORINATION

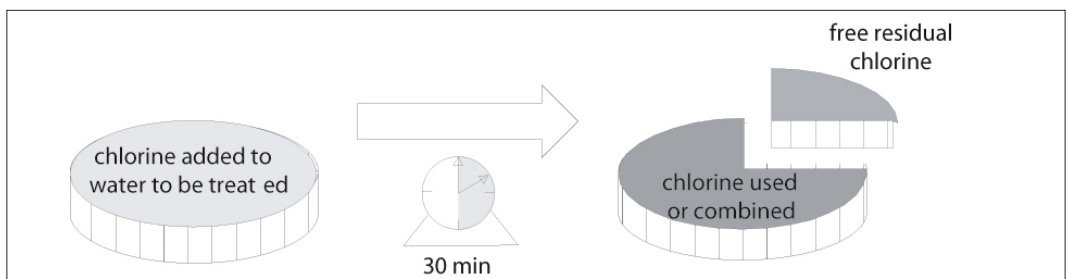
Chlorine is an oxidant: in aqueous solution, it reacts with all the oxidisable matter present, both inorganic (iron, manganese etc.) and organic. This reaction can be expressed in terms of chlorine demand. If the quantity of chlorine added to the water is enough to fulfil this demand, the unused chlorine is found in a free form in the water: this is called free residual chlorine (Figure 12.2). The chlorine used to fulfil the demand is called combined residual chlorine.

To make sure that the quantity of chlorine added to the water to be treated is sufficient, it is necessary to check for the presence of free residual chlorine. Also, free residual chlorine is what protects the water against new forms of pollution which may appear after the disinfection process: this chlorine remains active for some time and can therefore kill new pathogenic organisms. Depending on storage conditions, free residual chlorine can persist from several hours to several days. A proportion of combined residual chlorine also remains as a disinfectant although far less effective than free residual chlorine. However, combined residual chlorine products are more stable and remain much longer than the free residual chlorine (useful in preventing post-contamination in piped systems).

Chlorination has many limitations. For adequate disinfection, turbidity must be less than 5 NTU. Occasionally, it is possible to chlorinate water with a turbidity of up to 20 NTU, but then the quantity of chlorine to be used is higher, the taste and smell of the chlorine are unpleasant, and disinfection is impaired. Pathogenic organisms fixed on the suspended matter are very difficult to destroy, and they may survive, even if there is free residual chlorine in the water after 30 minutes.

Chlorination is much less effective if the pH is higher than 8. This is because chlorine is present in different forms, depending on the pH of the water (hypochlorous acid (HClO) at low pH, hypochlorite ions (ClO<sup>-</sup>) at high pH). Since the most highly effective form is hypochlorous acid, disinfection is better under acidic conditions (Degrémont, 1989).

Disinfection depends on two parameters: the dose of disinfectant and the duration of contact between the disinfectant and the water (contact time). All the doses given in this chapter are calculated for a minimum contact time of 30 min, which must be maintained. If the contact time is less, the



**Figure 12.2: Chlorine in solution in water.**

\* According to WHO: normal chlorination conditions (0.5 mg/l of free residual chlorine, at least 30 min of contact, pH lower than 8 and turbidity less than 1 NTU) reduces the number of *E. coli* and certain viruses by much more than 99%, but has far less effect on the number of protozoan cysts and oocysts.

chlorine dose must be higher. It is considered that the product [contact time (min) x free residual chlorine (mg/l)] must be around 15 mg/l.min: about 1 mg/l.min is enough to destroy 99.9% of a population of *E. coli*, but about 10 times more is necessary for poliovirus 1 (Degrémont, 1989).

Chlorination must not be carried out in uncoated or unlined metallic containers, since the chlorine will oxidise the metal. In emergencies, it is possible to use enamelled or painted metal recipients (food-grade paint), but ideally plastic should be used.

Chlorine gas is difficult to use in emergency programmes. Chlorine-generating products, which liberate chlorine in aqueous solution, are therefore used. These products occur in different forms (Table 12.IV), and their active chlorine concentration may be expressed as follows:

- in percentage, where 1% = 10 g/l;
- in degrees of chlorine, where 1° Cl = about 3 g/l;
- in milligrams per litre, where 1 mg/l = 1 ppm = 0.0001%.

Preferably, high-test hypochlorite (HTH) should be used: it keeps well (loss of 2% of chlorine per year) in a non-metallic, hermetically sealed container, away from light and heat. It is nevertheless very corrosive and must be handled with great care (in case of contact, rinse thoroughly with water). HTH is subject to very strict air transport regulations and can only be transported in special containers.

**Table 12.IV: Chlorine-generating products.**

Chlorine-generating product	Active chlorine content	Comments
Calcium hypochlorite (e.g. HTH)	70% in powder	Preferable for collective treatment
Sodium dichloro-isocyanurate (NaDCC)	60% in powder 1.5 g / tablet	In tablet form for household distribution
Sodium hypochlorite (e.g. Javel water 12 or 15 °Cl)	4% or 5% in liquid	Keeps for a very short time after being opened
Chloramine T	25% in tablets	Reserved for individual usage

## 1.4.2 IMPLEMENTATION

### 1.4.2.1 Preparation of the stock solution

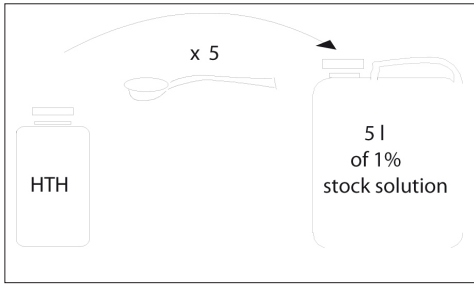
For regular chlorination of water, a 1% stock solution of 10 g/l of active chlorine, prepared from a chlorine-generating product is used (Table 12.V). It is easier to use a solution than a solid product. The stock solution must be kept in a sealed plastic jerry can, away from light, and for no more than three or four days.

To prepare 5 l of stock solution from HTH (Figure 12.3), mix 5 tablespoons of HTH in a plastic jerry can and shake well.

**Table 12.V: Preparation of 1% solution.**

**As a guide to quantities: 1 tablespoon contains about 15 g or 15 ml of product, a teaspoon 5 g or 5 ml.**

Product and active chlorine concentration	Dilution
Calcium hypochlorite - HTH at 70%	15 g/l
Sodium dichloro-isocyanurate (NaDCC) at 1.5 g per tablet	7 tablets/l
Sodium hypochlorite - Javel water 12 °Cl (15 °Cl)	250 ml/l (200 ml/l)

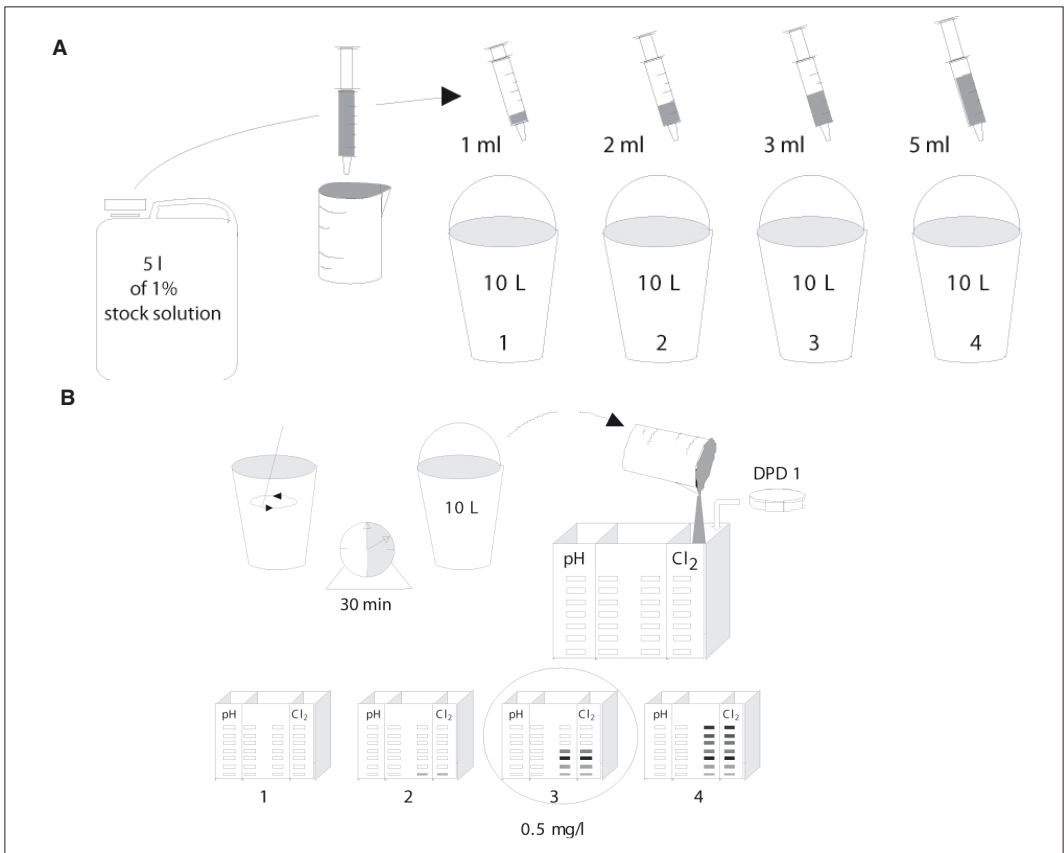


**Figure 12.3: Preparation of stock solution of chlorine.**

#### 1.4.2.2 Dose required (jar test)

It is not necessary to carry out this test every day. On the other hand, free residual chlorine must be measured after each chlorination. The test is carried out as follows:

- Fill 4 plastic buckets, each with 10 l of water to be treated (Figure 12.4).
- With a syringe, add to each bucket increasing doses of 1% stock solution, so as to cover the usual dosage range of 1 to 5 mg of active chlorine per litre of water. For example:
  - bucket 1: 1 ml of 1% stock solution, i.e. 10 mg of chlorine in 10 l of water, i.e. chlorine concentration 1 mg/l;



**Figure 12.4: Jar test.**  
**A: preparation of solutions. B: selection of dose.**

- bucket 2: 2 ml of stock solution, i.e. chlorine concentration 2 mg/l;
  - bucket 3: 3 ml of stock solution, i.e. chlorine concentration 3 mg/l;
  - bucket 4: 5 ml of stock solution, i.e. chlorine concentration 5 mg/l.
- Stir vigorously and leave to work for 30 min.
- Measure the free residual chlorine and choose as a reference the dose which allows between 0.5 and 1 mg/l of free residual chlorine to be obtained.

#### 1.4.2.3 Chlorination in the tank

To ensure good mixing, the solution is added when the tank is being filled. For large volumes of water, it is possible to use an automatic feeder (see Section 3). After 30 min contact time, the free residual chlorine is measured.

The main properties of HTH, the most widely used chlorine-generating product, are summarised in Table 12.VI.

**Table 12.VI: Summary of properties of HTH.**

#### Properties

Active chlorine content in commercial product: about 70%

Solubility limit: 225 g/l

Alkaline reagent: causes an increase in the pH of the water

#### Use of the commercial product

1% stock solution → 15 g/l → 1 tablespoon/l

Usual doses: 2 to 15 mg/l of HTH → 2 to 15 ml of stock solution per 10 l of water to be treated

1 kg of HTH treats 50 to 500 m<sup>3</sup> of water

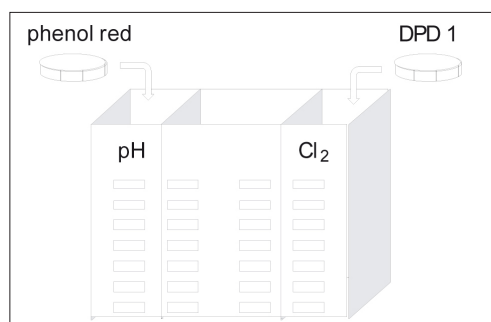
pH of the water to be treated < 8

### 1.4.3 MEASUREMENT OF FREE RESIDUAL CHLORINE

Free residual chlorine must be measured regularly after the water has been disinfected with chlorine: it is the only way of ensuring that disinfection has been effective. This analysis must be carried out in different parts of the water-supply system: at the outlet of the disinfection tank, at the taps, and in household water-storage containers. It is essential to know the value of free residual chlorine at the point of consumption, that is, in the home. This free residual chlorine must be between 0.5 and 1 mg/l; a concentration of 0.5 mg/l is recommended.

The dosage is calculated as follows:

- rinse the pooltester (colour comparator) before use;
- dissolve one DPD1 tablet in the chlorine compartment and one phenol red tablet in the pH compartment (Figure 12.5);
- if the pH > 8, the free residual chlorine should be greater than 1 mg/l;



**Figure 12.5: Pooltester.**

## Box 12.2

### Boiling.

Boiling is an effective way of disinfecting water, that works even when the water is turbid. Nevertheless, this method has some serious disadvantages, which limit its usage to situations where no other technique is possible:

- on average, 1 kg of wood is necessary to boil 1 l of water;
- the water must be taken to a rolling boil, to ensure sufficient heating for pathogen removal. At high altitudes, boiling should be maintained for 2 min per 1 000 m above sea level;
- boiling deaerates the water and imparts a taste to it;
- as opposed to chlorination, no disinfectant remains in the water after treatment.

- if the chlorine generator is chloramine T, the residual chlorine is found only in combined form, so one DPD 1 tablet and one DPD 3 tablet are used;
- if the concentration of residual chlorine is very high, there may be a false negative result because the chlorine bleaches the reagent.

## 1.5 Filtration

There are different methods of filtration specific to different types of water pollution (Table 12.VII).

**Table 12.VII: Various filters and their application.**

Filtration technique	Application	Technical parameters
Ceramic-candle filters	Domestic use Treatment of turbidity Katadyn®-type filter: removal of pathogenic organisms	Filtration threshold: 0.45 µm Katadyn-type filter: 0.2 µm Flow: 1 to 4 l/h
Rapid sand filters	Treatment of turbidity Treatment of iron / manganese	Filtration rate: 10 m <sup>3</sup> /m <sup>2</sup> /h Filter medium: sand 1-2 mm, UC* = 1.5 Thickness: 0.5 to 1 m
Slow sand filters	Treatment of faecal pollution	Turbidity < 20 NTU Filtration rate: 0.2 m <sup>3</sup> /m <sup>2</sup> /h Filter medium: sand 0.2 mm, UC = 2 Thickness: 0.6 to 1 m sand + 0.4 m gravel

\*UC = Uniformity coefficient – the ratio of sieve sizes through which 60% and 10% of the sand passes.

### 1.5.1 CERAMIC-CANDLE FILTRATION

Ceramic-candle filters are very suitable for domestic use, or in small health structures. The use of Katadyn®-type filters is recommended, since their fine filtration (0.2 µm) provides an effective treatment against pathogenic organisms (with the exception of viruses, whose removal is very limited).

### 1.5.2 RAPID SAND FILTERS

Basically, these filters provide mechanical water treatment and are used to treat turbidity higher than 20 NTU. The principle involves passing the water through a filter bed of fine sand (1-2 mm) of more or less uniform diameter (UC near 1.5). To prevent the filter from becoming blocked too quickly,



the flow rate of the water must not be too high: a flow of 10 m<sup>3</sup>/h per m<sup>2</sup> of filter surface is a good compromise. It is also possible to pass the water through a layer of coarser material (gravel) before the sand layer to pre-filter the water and slow down the blocking process.

For example, ACF used rapid sand filters in Juba, Sudan in 1991 to treat the water of the Nile, the turbidity of which is very variable. These filters, located in 200-l barrels, allow an acceptable level of turbidity to be achieved before disinfection. They are cleaned by back-washing.

Rapid sand filters can be used to collect flocs after flocculation. In this case, it is advisable to maintain a water flow rate of about 3 - 5 m<sup>3</sup>/h per m<sup>2</sup> of filter surface. Filters of this type can be built into Oxfam-type water tanks.

### 1.5.3 SLOW SAND FILTERS

Slow sand filtration consists of passing the water through a filter material, at a lower flow rate than in rapid sand filtration: a maximum of 0.2 m<sup>3</sup>/h per m<sup>2</sup> of filter surface is generally satisfactory. This slow rate allows the development of a great variety of organisms in the first few centimetres of sand. These organisms form a biological membrane, called a *schmutzdecke* (from the German: *dirt cover*), which decomposes the organic matter and provides an effective biological treatment against faecal pollution. Slow sand filtration can also be used to reduce turbidity, but the fineness of the sand only allows the treatment of fairly non-turbid water: it is not advisable to use a slow filter when the average turbidity is higher than 20 NTU. A turbidity of 150 to 200 NTU can be acceptable, but only for a few days, because of the risk of a rapid blockage.

When the filter is blocked, its flow decreases significantly. Maintenance then consists of removing the first 2 to 5 cm centimetres of sand, and then putting the filter into service again. When the thickness of the filter bed is down to around 60 cm, it is necessary to recondition the filter by adding clean sand. To avoid interrupting the water supply, two filters, which work in parallel or alternately, are usually installed.

The development and maintenance of the *schmutzdecke* requires particular conditions: it must always be under water, and the flow must be continuous and slow. It is therefore important to size the filter on the basis of demand (flow/area ratio), and to implement a system of flow regulation to control the level and flow rate of water through the filter. When these conditions are fulfilled, the biological membrane develops in 1 - 2 weeks.

Slow sand filters may be built using 70 m<sup>3</sup> and 95 m<sup>3</sup> Oxfam-type tanks (kit available).

## 1.6 Aeration

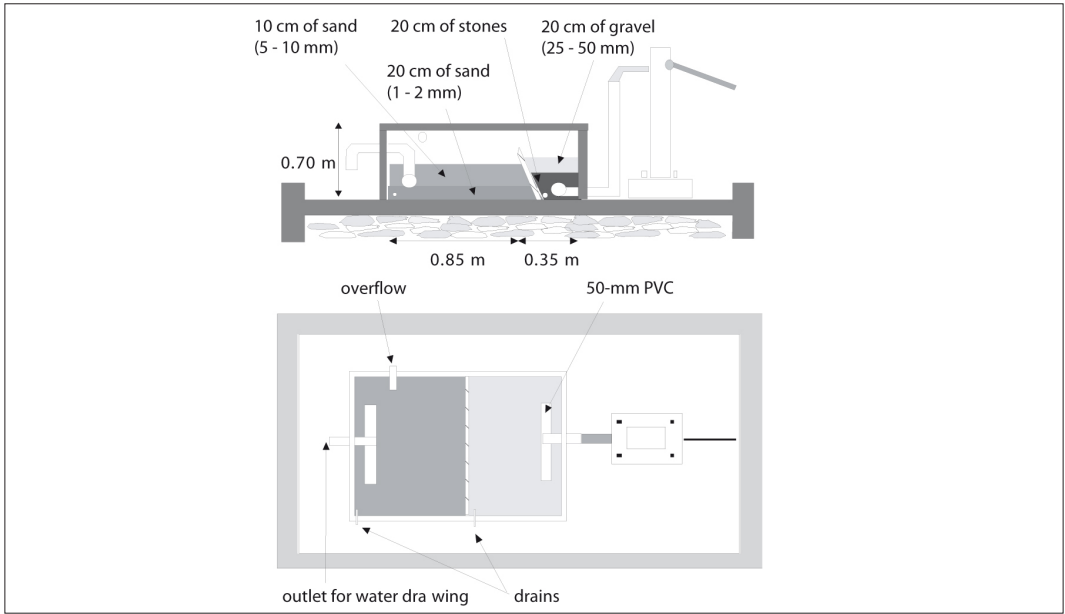
This technique, which is easy to use, accelerates the interaction between water and air. Atmospheric oxygen oxidises dissolved matter such as iron, which is sometimes present in excessive quantities in groundwater. Aeration also oxygenates the water and removes excess CO<sub>2</sub>. Generally, aeration removes unpleasant odours and certain tastes.

A diffuser (like a shower head) can be installed at the inlet to storage tanks to facilitate aeration; this decreases the risk of anaerobic conditions and corrosion problems in the distribution system.

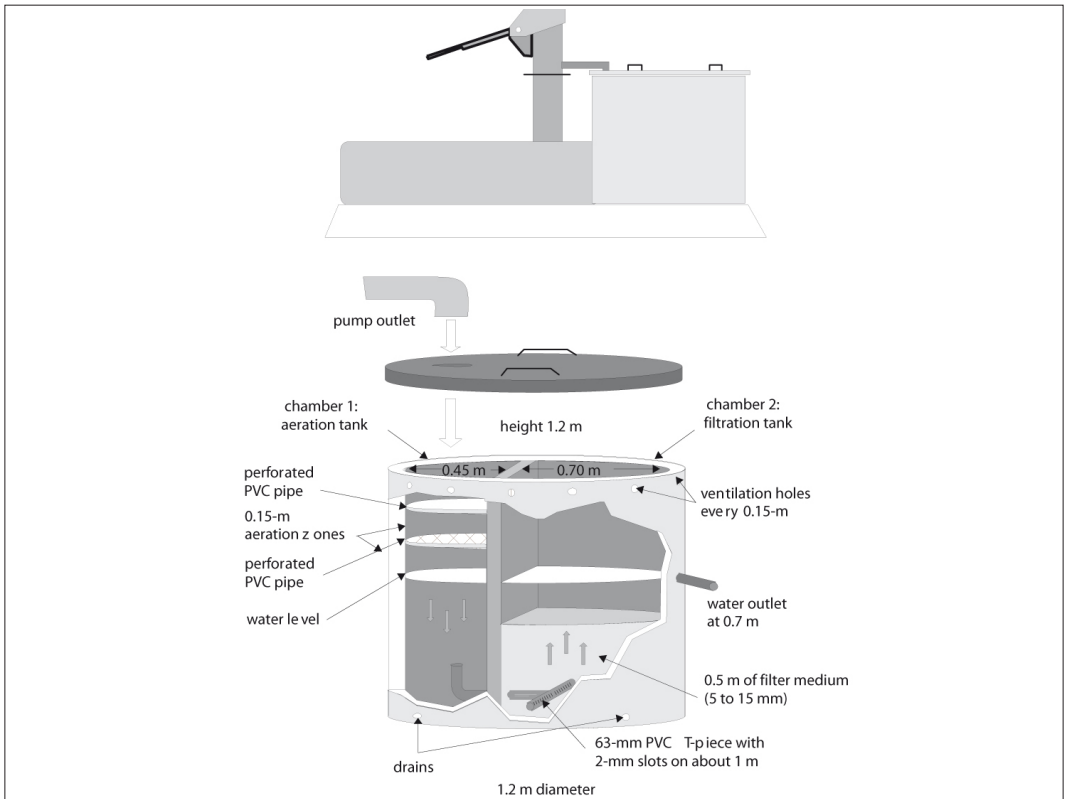
An aerator can be installed at the outlet of handpump, to remove iron. The precipitates formed as a result of aeration are removed by sedimentation or, even better, by filtration (Figures 12.6 and 12.7). Filters installed in Cambodia by ACF have reduced iron concentrations of 3 to 15 mg/l in some boreholes to less than 0.3 mg/l.

Nevertheless, the mechanisms which govern the precipitation of iron depend on numerous factors, such as temperature, redox potential, pH etc. Depending on the pH/redox potential combination, iron occurs in different forms, with certain complexes which are less easy to eliminate by a simple process.

Generally, it is considered that the higher the pH and the nearer the water to being saturated in oxygen, the more rapid will be the precipitation of the dissolved iron by aeration.



**Figure 12.6: Removal of iron by aeration and filtration.**

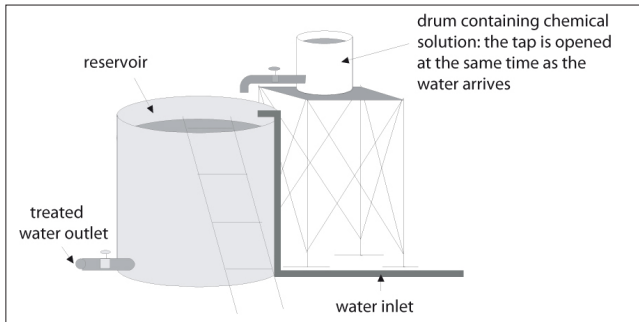


**Figure 12.7: Removal of iron by forced aeration and filtration (using a concrete ring)**  
 (source: Partners for development, 1997).

## 2 Chemical dosing

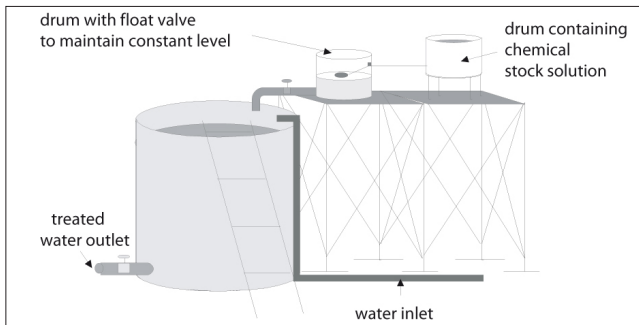
To treat large volumes of water, a dosing system for aluminium sulphate and chlorine is installed. This provides effective control over the quantities of chemicals used, and therefore increases the efficiency of the treatment. Various techniques are possible.

Batch dosing consists of adding a constant volume of chemical to a known volume of water to be treated (Figure 12.8). This should be the first option to be considered, since it is the simplest to use. Nevertheless, it is not very satisfactory for flocculation, because mixing does not take place very quickly, and the rate of addition of coagulant is not constant, but decreases as the level of water in the chemical tank falls.



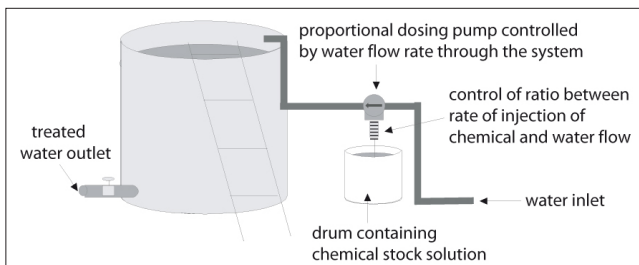
**Figure 12.8: Addition of chemical to a treatment tank using a drum. The rate of addition of the chemical varies with the depth of solution in the drum.**

Constant-flow dosing is carried out using a device which maintains a fixed level of solution in the chemical tank (Figure 12.9). This device can be made locally, or purchased (e.g. the SATTE gravity feeder).



**Figure 12.9: Addition of chemical at a constant rate.**

Proportional-flow dosing is carried out with a feeder which modifies the injection rate of the chemical solution depending on the flow rate of water to be treated (Figure 12.10). There are several different kinds of equipment available, either dosing pumps or venturi devices. They include conventional dosing pumps, the Promix rotational dosing pump etc. The easiest to use is the Dosatron dosing pump, which can be mounted directly onto the pump discharge pipe.



**Figure 12.10: Proportional dosing.**



IV

# Sanitation



# Sanitation

<b>1</b>	<b>Introduction</b>	458	4.5	Composting latrine	482
1.1	Sanitation as a global problem	458	4.5.1	<i>Advantage and disadvantages</i>	482
1.2	The importance of sanitation	458	4.5.2	<i>Composting process</i>	483
<b>2</b>	<b>Sanitation-related diseases and their control</b>	459	4.5.3	<i>Examples</i>	483
<b>3</b>	<b>Key elements for the implementation of an environmental sanitation project</b>	460	4.5.3.1	LASF composting latrine in Guatemala	483
3.1	Importance of socio-cultural factors and of the community perception of sanitation	460	4.5.3.2	Composting barrel latrine in El Salvador	485
3.1.1	<i>An obligatory step</i>	460	4.5.3.3	Vault latrines in Kabul	486
3.1.2	<i>Socio-cultural factors, beliefs and practices</i>	460	4.6	Latrines for rocky and frozen ground, high groundwater levels and flood-prone areas	488
3.1.3	<i>Sanitation and gender</i>	461	4.7	Excreta control in IDP or refugee camps	489
3.2	Sanitation promotion	461	4.7.1	<i>Defecation fields or trenches</i>	490
3.3	Working modes and community participation	462	4.7.2	<i>Simple latrines</i>	491
3.4	School sanitation and children's issues	462	4.7.3	<i>Semi-permanent or permanent latrines</i>	493
3.5	Sanitation and groundwater contamination	463	<b>5</b>	<b>Other environmental sanitation activities</b>	493
<b>4</b>	<b>Excreta disposal</b>	464	5.1	Personal hygiene structures	493
4.1	Defecation in open areas	465	5.1.1	<i>Facilities for washing hands (and anal cleaning)</i>	493
4.2	Dry latrines	465	5.1.2	<i>Shower and laundry areas</i>	493
4.2.1	<i>Simple Pit latrine</i>	465	5.1.2.1	Showers	493
4.2.2	<i>Ventilated Improved Pit (VIP) latrine</i>	466	5.1.2.2	Laundry areas	495
4.2.3	<i>Construction</i>	467	5.2	Grease traps	496
4.2.3.1	Materials	467	5.3	Surface-water drainage	496
4.2.3.2	The pit	467	5.4	Vector control	497
4.2.3.3	The slab	468	5.4.1	<i>Methodology</i>	497
4.2.3.4	The superstructure	472	5.4.2	<i>Use of insecticides</i>	498
4.2.4	<i>Use and maintenance</i>	472	5.4.2.1	Implementation on site	499
4.3	Pour-flush latrine	474	5.4.2.2	Products and preparation of solutions	499
4.3.1	<i>The principle</i>	474	5.4.2.3	Organisation of storage premises and preparation of insecticides	499
4.3.2	<i>Construction</i>	474	5.5	Management of solid waste	500
4.3.3	<i>Septic tank</i>	475	5.5.1	<i>Introduction</i>	500
4.3.3.1	The principle and its limitations	475	5.5.2	<i>Burial</i>	500
4.3.3.2	Design of a septic tank	477	5.5.3	<i>Incineration</i>	501
4.3.4	<i>Aqua-Privy</i>	478	5.5.4	<i>Urban contexts</i>	502
4.3.5	<i>Use and maintenance</i>	479	5.5.5	<i>Management of health-centre waste</i>	503
4.3.6	<i>Disposal of septic-tank effluent</i>	479			
4.4	Advantages and disadvantages of simple, VIP and pour-flush latrines	482			

# 1 Introduction

## 1.1 Sanitation as a global problem

According to WHO and UNICEF, millions of children suffer from malnutrition, low school-attendance rates, and economic losses due to diarrhoeal diseases that are preventable by adequate sanitation. Human excreta spreads intestinal parasites, which affect 1.5 billion people around the world (WHO, 1998), and is also responsible for the transmission of diseases such as shistosomiasis, cholera, typhus, and many other infectious diseases affecting hundreds of millions of people. The most affected populations live in extreme poverty in developing countries, particularly in peri-urban and rural areas.

Table 13.I shows global sanitation coverage and that of developing countries in 1990 and 2000. It is worth noting the difference between rural areas (40%) and urban areas (83%). The sanitation coverage is even lower in the rural areas of the least developed countries (35%). Further, while there has been an important world-wide improvement in sanitary conditions between 1990 and 2000, the least developed countries have not improved at the same rate, as indicated by the very low sanitation figures.

**Table 13.I: Sanitation Coverage Data ( source : Global Assessment 2000, Who and UNICEF Joint Monitoring Programme, <http://www.wssinfo.org>).**

	1990 Population served (%)	2000 Population served (%)
Global Sanitation Data		
Urban	79	83
Rural	28	40
TOTAL	51	60
Least Developed Countries		
Urban	73	71
Rural	33	35
TOTAL	41	44

## 1.2 The importance of sanitation

Studies (Esrey et al. 1991) have shown that the most significant reductions of diarrhoeal diseases are achieved via sanitation and hygiene promotion improvement, whereas improvement of water supply alone has a more limited impact on health (reduction of diarrhoeal morbidity of 36% through sanitation improvement and 16% through improvement of water quality alone), see Figure 15.2. Despite this, sanitation is often seen as a simple add-on to water supply projects and not considered as an independent solution to a need. In other cases, large investments made on water-distribution systems often have limited impact on health, due to the lack of sanitation activities on the same project.

Hence, when the general objective of a project is to reduce the risk of morbidity, water supply, sanitation and hygiene promotion interventions have to be planned and implemented in an integrated manner.

In some emergency contexts, where there are high concentrations of people in camps for refugees or internally displaced persons (IDPs), the risk of epidemic outbreaks (e.g. of cholera, bloody diarrhoea etc.) is high, as sanitary risks increase with increasing population density. Here, excreta control is a key factor that may limit the development and transmission of diseases. Thus, in an emergency intervention, provision of sanitary infrastructures, particularly those related to excreta disposal, must be considered as a priority.



Environmental Sanitation includes the following: excreta-disposal systems, waste-water disposal systems, solid-waste disposal systems, rain-water drainage systems, and vector control. This chapter deals essentially with the management and disposal of human excreta and briefly presents other aspects of environmental sanitation.

## 2 Sanitation-related diseases and their control

Pathogenic organisms that cause intestinal diseases (see Table 13.11), live in excreta or faecal materials of humans and animals. Infection of a human being occurs via:

- the direct contact of unclean hands with the mouth or with food and water;
- the use of water contaminated with faecal material;
- transmission through the fertilization of agricultural land with faecal material or black-water (effluent of wet latrines or sewerage systems);
- vector transmission.

The inappropriate disposal of solid and liquid waste contributes to the development and transmission of several types of diseases as it facilitates the development of pathogens, and of vectors (see Section 5.4).

Table 13.II shows a summary of a classification of pathogens according to the diseases they transmit and their origin.

Table 13.III shows the potential impact of sanitation and personal hygiene on the different groups of excreta-related diseases. For the majority of these diseases, excreta-disposal systems are one of the important control measures.

**Table 13.II: Pathogens present in urine, excreta and grey-water (domestic wastewater)**  
(source: Franceys, Pickford & Reed, 1992).

Pathogen	Name of the disease	Present in		
		urine	excreta	grey-water
<b>Bacteria</b>				
<i>Escherichia coli</i>	Diarrhoea	X	X	X
<i>Leptospira interrogans</i>	Leptospirosis	X		
<i>Salmonella typhi</i>	Typhus	X	X	X
<i>Shigella</i> spp.	Shigellosis		X	
<i>Vibrio cholerae</i>	Cholera		X	
<b>Viruses</b>				
<i>Poliovirus</i>	Poliomyelitis		X	X
<i>Rotaviruses</i>	Enteritis		X	
<b>Protozoa - amoeba or cysts</b>				
<i>Entamoeba histolytica</i>	Amoebiasis		X	X
<i>Giardia intestinalis</i>	Giardiasis		X	X
<b>Helminths - parasite eggs</b>				
<i>Ascaris lumbricoides</i>	Roundworm		X	X
<i>Fasciola hepatica</i>	Liver fluke		X	X
<i>Ancylostoma duodenale</i>	Hookworm		X	X
<i>Necator americanus</i>	Hookworm		X	X
<i>Schistosoma</i> spp	Shistosomiasis	X	X	X
<i>Taenia</i> spp	Tapeworm		X	X
<i>Trichuris trichiura</i>	Whipworm		X	X

**Table 13.III: Impact of sanitation and personal hygiene on excreta-related diseases (source: adapted from Cairncross & Feachem 1993).**

	Category	Sanitation Impact
I	Faecal-oral non-bacterial	Negligible
II	Faecal-oral bacterial	Weak to moderate
III	Soil-borne helminths	Strong
IV	Cow and pig parasites	Strong
V	Water-borne helminths	Moderate
VI	Vectors (insects)	Weak to moderate

### 3 Key elements for the implementation of an environmental sanitation project

#### 3.1 Importance of socio-cultural factors and of the community perception of sanitation

##### 3.1.1 AN OBLIGATORY STEP

The success of sanitation projects depends on their acceptance by the community and of their suitability to the community's living conditions. This is true for all types of project, but it is especially important for sanitation programmes. Sanitation issues are intimately related to the habits and behaviour of the community, which are substantially affected by social and cultural factors.

Consequently, the first step towards the design of a sanitation project is the assessment of the different socio-cultural and behavioural factors related to sanitation. As such, the involvement of the community from the design and planning stages of the project is important. The relevance of the sanitation system to needs depends not only on a good technical design but also on its acceptance by the community, and must be adapted to their living habits. The importance of anal cleaning habits (usage of water, stones, paper etc.) is an example of how community habits influence the design of a sanitary system.

##### 3.1.2 SOCIO-CULTURAL FACTORS, BELIEFS AND PRACTICES

Excreta control is a very sensitive issue for many communities and special attention is required to deal with cultural and religious factors. Defecation is often a private matter that people are hesitant to talk about due to embarrassment, disgust or other personal reasons.

Sanitation has a religious connotation for some cultures. For instance, people might bury excreta to eliminate bad spirits. For another example, in the emergency sanitation programme ACF carried out in the Mindanao region of the Phillipines, the team realised after the construction of several latrines that those facing Mecca were not used. This factor had to be integrated into the construction of new latrines.

In other cultures it has a social connotation. Contact with excreta may be unacceptable or may be the responsibility of specific social groups, and addressing this issue might require different strategies depending on the structure of the society.

The links between the lack of sanitation and occurrence of diseases is not clear to many communities. However, the behaviour of individuals regarding sanitation has a logic and people are often conscious of the environmental causes leading to the deterioration of health. In general, there is an understanding of the environment, not only in a physical sense but also of its relationship with social and spiritual factors. This holistic vision of the environment is imbedded in many cultural beliefs and habits that affect sanitary behaviours and the use of water. Therefore, it is crucial to determine how

the beliefs, knowledge and management of the environment by the community affect sanitation and how these can be adapted for any potential programme. The most important thing is to be aware of, and respect, the beliefs of the community.

Community habits are not only related to beliefs but also to knowledge. For example, numerous communities around the world believe that children's excreta does not constitute any danger to health, when in fact children have a higher incidence of excreta-related diseases than adults (Thomson et al. 2001), so their excreta is more often pathogenic. This misconception is an important factor in the transmission of disease. Failing to consider this belief would largely reduce the impact of the project.

Community beliefs and practices have to be comprehensively analysed before choosing the technical designs and implementation methods of any sanitation project. Techniques such as KAP (Knowledge, Attitudes and Practices) assessments, and more participatory techniques, are used to perform this analysis. These techniques are presented in Chapter 15.

The results of these assessments allow the planning of:

- the method of implementation of the project (including the potential for community participation);
- technical characteristics of sanitary infrastructure (standard latrine designs, water use, maintenance etc.);
- and the location of the latrines (inside or outside the house, orientation of the door, indication for women, security for vulnerable groups etc.).

### 3.1.3 SANITATION AND GENDER

Gender is an important issue affecting a sanitation intervention because of the different perception among men and women regarding sanitation, different needs and habits, and because men and women play different roles in sanitation management.

Women are often responsible for hygiene and sanitation tasks in a community, and for the education of children. In general, women have a better perception of the impact of sanitation on health than men, and are often more pro-active on this issue. Therefore, they are an important means for disseminating information to all members of families within the community. Hence, the participation of women is a key factor in the success of a sanitation project.

Privacy and the risk of sexual abuse are also important when considering the needs of women. Concerning privacy issues, it is important to be aware that in many cultures it is unthinkable that men and women would share the same latrine. Access to public latrines or latrines outside of the house may also be forbidden for women in Muslim countries. For instance in Kountaya, Guinea Conakry, ACF segregated latrines according to gender. Concerning sexual violence, building latrines in isolated, bushy areas without lighting can be dangerous for women during the night, especially in refugee camps.

## 3.2 Sanitation promotion

Many people do not consider sanitation as a priority, due to lack of knowledge and awareness, and hence they are not convinced of its importance to health.

Although communities often request water and energy interventions, environmental sanitation is rarely asked for.

Consequently, when the need for a sanitation project is identified, the key issue is to stimulate demand through promotion activities. However, hygiene promotion must not be considered as a secondary task or simply as an activity attached to the construction of sanitation facilities. Hygiene-promotion techniques and methodologies are described in Chapter 15.

The acceptance of sanitation facilities by the community depends not only on their understanding of the impact of sanitation on health, but also on other social factors. For instance, it is possible

to promote community pride or ownership in the construction of new latrines. The ownership and use of a latrine by some people in a community, compared to others who continue to defecate in the open, may be used in social promotion, where latrine owners showcase their latrine to others, and thus promote the desire for having a latrine among the entire community. The technical design of the latrine has to integrate such factors. For instance, it is possible to promote the construction of VIP latrines, using the distribution of ventilation pipes to generate interest.

### 3.3 Working modes and community participation

Community participation is crucial for the success of sanitation projects. A higher level of community participation means a higher degree of ownership of the project by the community and an increased potential for success and sustainability of a clean environment. Considering the problems related to many people's interest in sanitation, it is of paramount importance to involve communities in each phase of the project, from the project definition to construction and maintenance. The degree of participation in a sanitation project is a measure of the degree of interest achieved in a community, and indicates the probability of success of the project.

Technically, sanitation works are not complicated. The role of the external technician consists of promoting the importance of sanitation, supporting people with materials if necessary and providing technical advice to the community.

Latrine construction (digging the latrine pit and building the superstructure) is mostly carried out by the community members themselves. Where concrete slabs are used in the latrine design, a slab workshop can be organised by the community, by the implementing organisation or by an external technician.

### 3.4 School sanitation and children's issues

Children are often one of the most vulnerable groups within communities, especially for health issues. They are generally more susceptible than adults to excreta-related infections, and prevalence of these diseases among school children is often relatively high. Schools are sites of high risk for disease transmission and must be considered an intervention priority for water and sanitation programmes.

Furthermore, as shown in previous sections, sanitation activities require a high level of support through hygiene promotion. Here, schools play an important role in the training and education of children. Children are more receptive to learning correct hygiene practices than adults, and a long-term impact on sanitation is more likely. An additional advantage of involving schools in hygiene promotion is the cooperation of teachers who are often qualified and have the trust of the children.

Sanitation interventions in schools have an impact on the entire community. On one hand the installations provide a model of correct sanitation, and on the other hand the children promote the construction of sanitation infrastructures and correct hygiene practices within their families. This is vital for a programme, considering that direct hygiene promotion with adults is often difficult, because of long-established beliefs and practices.

The sanitation facilities in schools need to be designed taking into account that they will be used by children, thus it is important to:

- set the height of the water points and hand-washing systems so that children may have access to them;
- take care with the dimensions of hole of the latrine slab;
- design ventilated latrines with an indirect entry and without doors, so that the cubicle remains sufficiently dark for fly control, as children tend to leave doors open;
- put emphasis on the maintenance of the structures, and involve the children in this through sensitisation about their correct use.

### 3.5 Sanitation and groundwater contamination

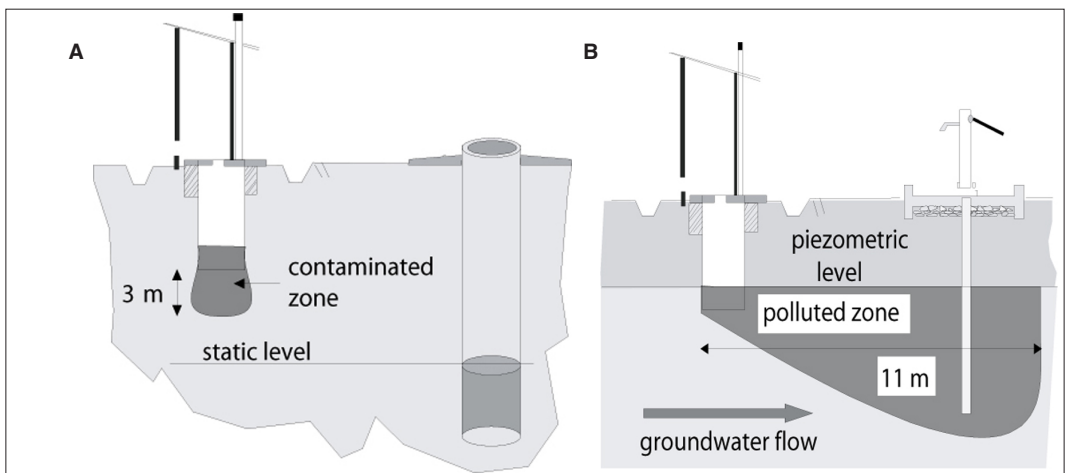
Groundwater contamination is a risk associated with the use of on-site sanitation. There is a risk of exposure to biological or chemical agents where the community's water is sourced from an aquifer close to the surface. This contamination is normally due to infiltration of these agents from latrines, leaching from solid-waste disposal sites or infiltration of domestic wastewater.

The risk of bacterial and viral contamination of groundwater depends on factors that include soil mineral composition and porosity, hydraulic gradient, soil organic content, soil pH and electrostatic properties, and rainfall. However, the most important factors are underground water flow and persistence of the micro-organisms in the environment. To be certain, a piezometric study and/or a tracer study should be carried out to define groundwater flow conditions accurately. It is impossible to define, a priori, the propagation pattern of bacterial pollution.

Nevertheless, according to the *Guidelines for drinking-water quality* (volume 3, WHO 1997), it is possible to define the minimum distance between latrines and water points using the following guidelines:

- in a non-saturated area, and therefore in the absence of groundwater flow, pollution migration is very limited: lateral pollution movement is almost non-existent and vertical movement is limited to 3 m (Figure 13.1.A). Nevertheless, in the event of massive infiltration of surface water (for example, heavy rain), the transport of pollution away from its source may be greater;
- in a saturated area with continuous groundwater flow, for a flow rate of 1-3 m/day, pollution moves up to 11 m in the direction of groundwater flow (Figure 13.1.B);
- in a fractured or karstic area, groundwater flow is difficult to predict, but is usually very rapid. Therefore, pollution can be carried over considerable distances. This was the case for a well rehabilitated by ACF in Myanmar in fractured micro-sandstone (under thin cover), where a correlation between high rainfall and a peak in pollution was observed.

However, it is not always possible to determine the exact nature and hydrological condition of underground formations, so a minimum safety distance of 30 metres between latrines and water points is widely recommended. If it is not possible to respect this distance, see Section 4.6 for technical options.



**Figure 13.1: Migration of bacterial pollution.**  
**A: non-saturated zone. B: saturated zone.**

### Box 13.1

#### Soil as a filter and decontamination agent.

Effluent that flows through unsaturated soil is decontaminated by filtration, adsorption and biological processes.

Protozoa and helminths are rapidly stopped by the filtering action of the soil, due to their relatively large sizes compared to soil pores. Bacteria and viruses are less easily fixed by soils. Table 13.IV presents the survival times of pathogenic organisms in different environments and Box 13.5 (in Section 4.3.6) shows infiltration rates according to the nature of the soil.

For bacteria (e.g. coliforms), a great decrease occurs in the first 50 mm of sandy soil.

Viruses are too small to be removed by filtration but are captured by adsorption onto the surface of soil particles, especially if the pH of the soil is low. The adsorption of viruses and bacteria is facilitated by soil clays, especially if groundwater flow is slow and contact time is long.

**Table 13.IV: Epidemiological characteristics of excreted pathogens (adapted from Franceys, Pickford & Reed,1992).**

Pathogen	Latency period	ID <sub>50</sub> <sup>a</sup>	Survival times for pathogens:		
			wastewater	soil	crops
Bacteria	0	>10 <sup>4</sup>	from a few days to 3 months		
<i>Vibrio cholerae</i>	0	10 <sup>8</sup>	~ 1 month	< 3 weeks	< 5 days
Faecal coliforms	0	~10 <sup>9</sup>	~ 3 months	< 2 months	< 1 month
Virus	0	unknown	months	months	1-2 months
Enteroviruses <sup>b</sup>	0	100	~ 3 months	< 3 months	< 2 months
Protozoa (cysts)	0	10-100	from a few days to several months		
<i>Entamoeba</i> spp.	0	10-100	25 days	< 3 months	< 10 days
Helminths <sup>c</sup>	variable	1-100	months	months	months
<i>Ancylostoma</i> spp.	1 week	1	3 months	< 3 months	< 1 month
<i>Ascaris</i> spp.	10 days	several	~ 1 year	several months	< 3 months
Flukes <sup>d</sup>	6-8 weeks	several	life of the host <sup>e</sup>	hours <sup>e</sup>	hours <sup>e</sup>

a. ID<sub>50</sub> is the number of organisms required to cause the development of clinical symptoms in 50% of individuals.

b. Includes poliovirus.

c. Eggs or larvae.

d. Does not include *Fasciola hepatica* but includes *Schistosoma* spp.

e. Outside of an aquatic host, the pathogen element survives only a few hours. In a host it lives until the host dies.

## 4 Excreta disposal

Excreta-disposal systems may be classified according to the following criteria.

### *Final excreta-disposal site*

– On-plot systems: where the disposal site for excreta is close to the home, such as latrines and septic tanks.

– Off-plot systems: where excreta is collected from the home and transported elsewhere to be treated or disposed of. The sewerage system is the most important example of this.

### *Necessity of water for operation*

– Dry systems: do not require water for use, including simple pit latrines, ventilated improved pit (VIP) latrines and composting latrines.

– Systems using water: where the system requires water for operation, including flush toilets connected to septic tanks or sewerage systems.

The selection of an appropriate system is based on technical, cultural, economic and institutional criteria.

The following section details the technological characteristics of on-plot systems for individual, communal or public toilets.

Public toilets are normally installed in public places where people are present temporarily or occasionally, such as hospitals, nutritional centres, schools or markets. In these places the systems are managed by those who are responsible for the public place.

Communal or individual toilets are necessary for family sanitation. Individual toilets are the best solution, given that acceptance and maintenance of the system will be easier to manage. In this case, communal latrines are only implemented in specific cases such as an emergency situation or where there are construction problems such as a lack of time or materials.

## 4.1 Defecation in open areas

People defecate in open areas where there are no, or insufficient, latrines or where latrines present are not used. These open areas may be specific places that are widely accepted by the community as areas of defecation, such as refuse piles or under trees, and may be found inside or outside the living area of the community.

In principle, this practice should be stopped because of the associated health risks and damage to the environment. However, if this is not possible in the short-term due to lack of community motivation for latrine construction, or because of any other socio-cultural factors, it is possible to improve the situation. This can be done by promoting correct hygiene habits such as hand-washing the covering of faeces with soil and defecation at a safe distance from water points, homes and public places.

It is important to increase the demand for latrines in a community through the introduction of pilot projects. For example, the introduction of a pit latrine, with a slab and adapted superstructure, could help to overcome the resistance of the community to defecate inside a walled superstructure, and could be the first step of a more comprehensive latrine project.

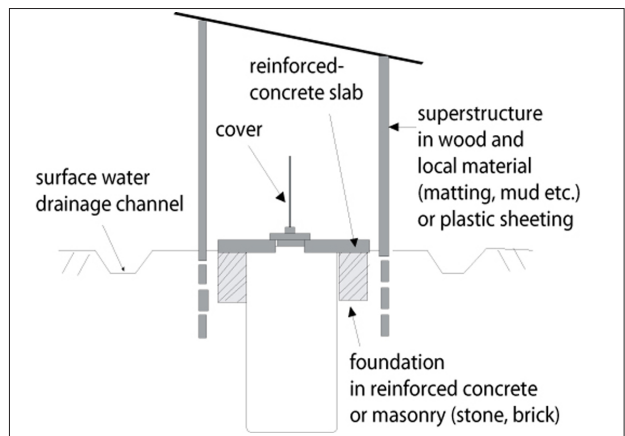
In emergency situations such as in refugee or IDP camps, defecation fields can be set up as an initial and rapid response to extremely urgent needs (see Section 4.7).

## 4.2 Dry latrines

### 4.2.1 SIMPLE PIT LATRINE

The most common excreta-disposal system in many parts of the world is the simple pit latrine used by families (Figure 13.2). This type of latrine is a simple, rapid and economical means of excreta disposal. It is often used as the first step to improve environmental sanitation.

This latrine consists of a pit, where excreta accumulate, covered by a slab and protected by a superstructure. A lid can be used to cover the defecation hole in the slab in order to reduce bad smells and the entrance of flies into the pit.



**Figure 13.2: Simple pit latrine.**



#### 4.2.2 VENTILATED IMPROVED PIT (VIP) LATRINE

The VIP latrine (Figure 13.3) is an improved version of the simple pit latrine, and includes several advantages:

- it reduces smells, which makes the latrine more acceptable to users (if the latrine has an unpleasant smell, the promotion of further latrine construction and use is difficult);
- it allows the control of flies, which can be a vector of disease.

The ventilation of the pit is achieved via a pipe that runs from the pit to 50 cm beyond the top of the latrine roof. A fine mesh is placed on the exposed top of the pipe in such a way as to trap flies inside the pipe.

The air flow is created by the venturi effect due to the wind blowing across the top of the pipe. In hot weather, the heating of the vent pipe can also encourage air flow. This air circulation from the pit through the pipe also eliminates bad smells.

Flies are attracted to the pit by the smell exiting the ventilation pipe, but are prevented from entering by the mesh. A few will enter through the pit via the defecation hole and will lay eggs in the pit. The flies that develop will be attracted by the light from the top of the ventilation pipe if the inside of the superstructure is kept sufficiently dark. They are prevented from escaping by the mesh at the top of the pipe, and eventually die.

The correct construction and use of the latrine is essential for operational efficiency:

- The front part of the latrine must allow the access of incoming air and the defecation hole of the pit must remain open.
- The inside of the superstructure must remain fairly dark. Therefore, the door must remain closed, or alternatively, an indirect entrance is constructed that minimises the entry of light (see Section 4.2.3.4). This solution is preferable, as the users may not keep the door closed.
- The ventilation pipe must have a diameter of at least 150 mm (6”) for smooth materials and 230 mm (9”) for rough materials, to allow the easy passage of air and movement of flies up the pipe.
- The top of the pipe must be higher than the roof by at least 50 cm and must be dark-coloured to promote heating by the sun. If possible, it should be installed to receive direct sunshine.
- The latrine must be placed downwind of people’s homes, with the front of the latrine (where the door is located) facing towards the prevailing wind, and the ventilation pipe at the back.

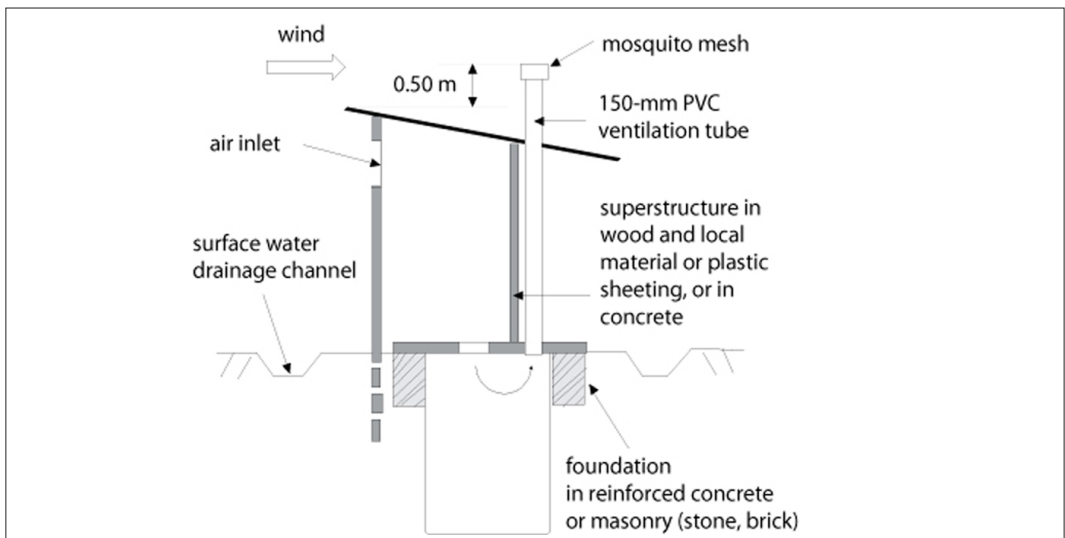


Figure 13.3: Ventilated Improved Pit (VIP).



## 4.2.3 CONSTRUCTION

### 4.2.3.1 Materials

Past experience indicates that it is better to use the same materials for the construction of latrines as for local housing. However, it may be more suitable to lower the standard of materials to achieve better coverage. The construction of latrines of a higher quality than that of local homes should be avoided because this would promote a standard that could not be met by the community and would, therefore, not encourage the construction of new latrines.

The introduction of new materials and methods should also be avoided in a latrine construction programme. It is more convenient to use local skills and materials since they are better understood by the community, who will also know how to maintain these materials. In this way, construction details, techniques, particularly for the superstructure, will depend on the materials used by communities in different regions, such as wood, thatch, woven grass, bamboo or earth.

### 4.2.3.2 The pit

#### 1) Sizing

The dimensions of the pit depend on several parameters including the following:

- number of users;
- expected lifetime of the latrine;
- pit cleaning method;
- type of pit (if it is lined or not);
- type of soil (if it is impermeable or not, and rocky or not);
- habits regarding anal cleaning; and
- contamination risks (high water-table).

The volume of the pit may be calculated using the following formula, taking into account the factors listed above and according to the objectives of the latrine, as presented in Box 13.2:

$$V = n \cdot r \cdot y$$

where  $V$  = the useful volume ( $\text{m}^3$ ),  $n$  = number of users,  $r$  = rate of accumulation of solids ( $\text{m}^3/\text{person}/\text{year}$ ),  $y$  = useful life of the pit latrine (years).

*Note.* – A depth of 0.5 m is added to the calculated pit depth, which corresponds to the free space under the slab.

#### Box 13.2

##### Useful life of pit latrines.

For a properly functioning latrine, in terms of hygiene, queuing time, and privacy, the number of people per latrine must not exceed 20 (or 50 in the first phase of an emergency) according to SPHERE key indicators.

From a technical point of view, the useful life of latrines must not be less than 2 years, which is the minimum time for the adequate decomposition of excreta. Ideally, the useful life should be around 5 years, in order for latrine use to become an accepted part of a community's habits, which would help guarantee their long term maintenance.

When the useful life of a latrine is more than 1 year, a solids accumulation rate of  $0.06 \text{ m}^3/\text{person}/\text{year}$  is used for dry pits and  $0.04 \text{ m}^3/\text{person}/\text{year}$  for wet pits, considering that decomposition processes in wet pits are more efficient than those in dry pits (Franceys et al., 1992). These rates are multiplied by 2 for latrines whose useful life will be less than 1 year (high number of persons per latrine, e.g. in camps).

The final dimensions of the pit will also depend on the anal-cleaning habits of the community. For instance, the volume of the pit will need to be increased where stones are used.

*Note.* – The emptying of a full pit is difficult or impossible in many contexts where the community does not accept to do this task. Here, an increase in the pit dimensions will increase the time of filling, and hence, life of the latrine.

## 2) Design and construction

The pit can be circular, rectangular or square. Circular pits are more stable due to the arching effect of the earth around the hole, which evenly distributes stress around the pit. However, square or rectangular pits are often used as they are easier to dig than circular pits.

The sides of the pit have an impermeable lining, a permeable lining, or are unlined (Figure 13.4). If possible, where the soil is consolidated and there is no risk of contamination (see Table 13.V), the pit walls should remain unlined to facilitate drainage of liquids. Where walls are lined, the most common materials used for this include cement or cement blocks, reinforced concrete, stones and stabilised mud blocks.

**Table 13.V: Type of pit depending on context.**

Recommended type of pit	Context
Latrine with a water-proof lining	Water resource exploited within a perimeter of 30 m around the latrines, or in very permeable terrain (sand, gravel, fractured rocky environment), i.e. pollution can extend 30 m beyond the latrine; in this case, the pit will need frequent emptying (see Section 4.2.4)
Latrine with a permeable lining (open masonry-work)	Loose or non-stabilised soil, no risk of pollution
Latrine with unlined pit	Stable soil, no risk of contamination of the aquifer

The final selection of pit design will depend on the characteristics of the local context. Table 13.V summarises different cases.

Technical points to consider:

- If the construction is designed to last longer than 5 years it is advisable to build a reinforced permeable pit or septic tank and soakaway.

- The inclusion of a permeable pit significantly increases the operational life of the latrine due to the increase of the infiltration and biological activity. If the pit is impermeable, it is essential to provide a system for handling the effluent.

- It is always preferable to build some kind of protection in the upper 300 - 500 mm of the pit that will function as a seal against water infiltration and as a support to the slab.

- In some cases, the pit can be easily and quickly protected using the moulds for concrete rings used in the construction of hand-dug wells.

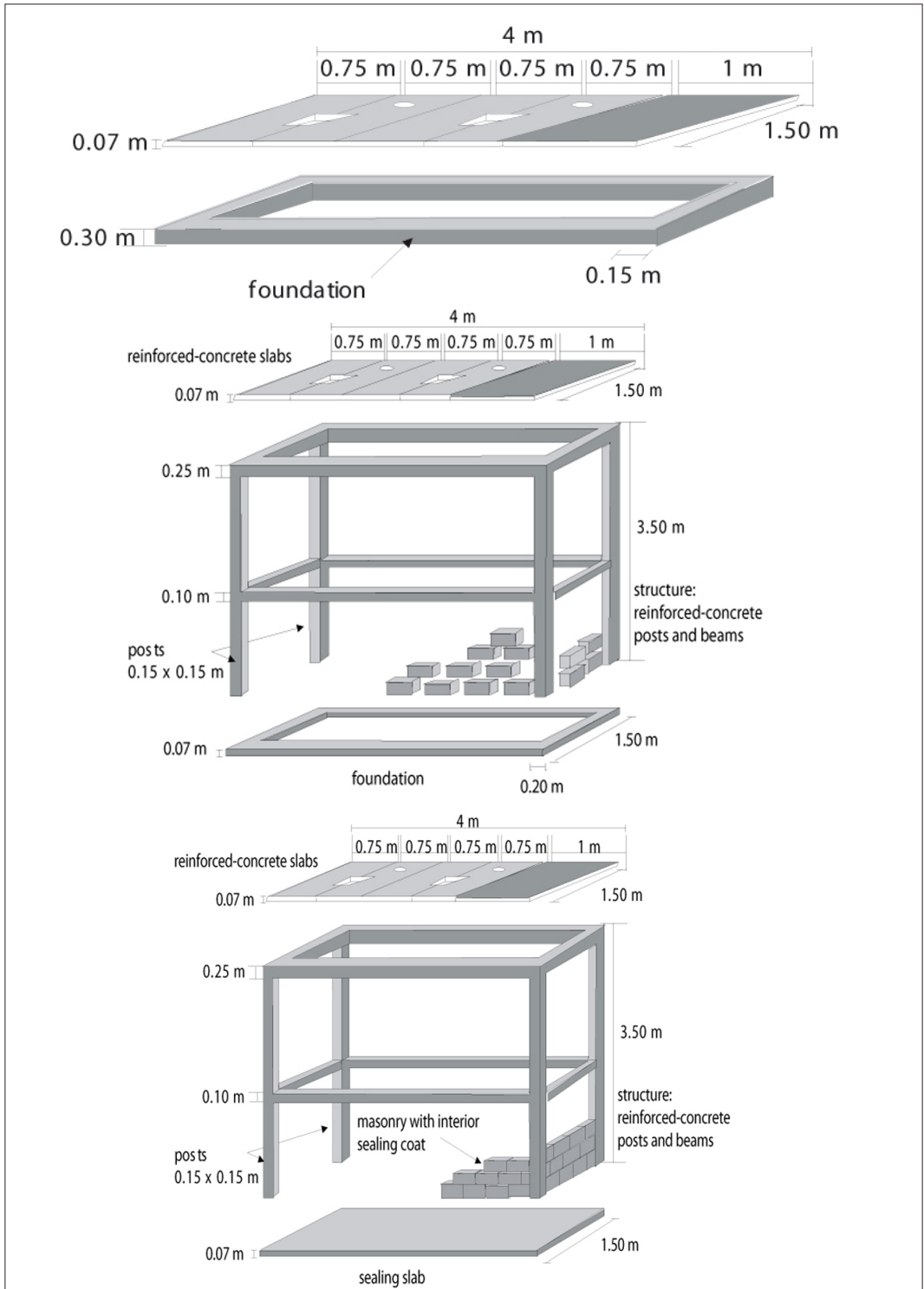
### 4.2.3.3 The slab

The latrine slab has two major functions: it covers the pit and supports the weight of users and, in some cases, the superstructure.

#### 1) General characteristics

The latrine slab must be smooth, impermeable and easy to clean.

The slab or the internal floor must be sufficiently large so that users are comfortable. The dimensions between walls are normally at least 80 cm wide and 100 cm long, so that users do not touch the walls while they are inside the latrine.



**Figure 13.4: Pit and foundation of 2-station latrine.**

**A:** slab on simple foundation, pit not lined. **B:** slab on masonry-lined pit. **C:** slab on watertight pit.

## 2) Design and construction

Latrine slabs are directly supported by the ground or by the pit lining. A correct design ensures that the slab is strongly supported and raised above the soil by at least 150 mm to avoid the entrance of surface water.

Slabs have square, rectangular, or circular shapes. They are submitted to different compression and tension forces, depending on their shape, and this can influence the materials and techniques used in construction.

Slabs can be built with traditional material such as wood (Figure 13.23, in Section 4.7.2) or with concrete. Pre-made slabs in plastic or metal can be also used, especially in emergency interventions (see Section 4.7).

Concrete slabs are a long-term solution for covering the latrine pit, but may be adapted to short-term interventions, as they are easy to make and transport, and cement is usually available and cheap. They are also useful because they can be assembled with other materials and make a water-tight seal.

There are two kinds of concrete slab: reinforced concrete slab (Table 13.VI, Figure 13.5 and Figure 13.6) and unreinforced concrete slab (Figure 13.7 & 13.8).

For an overview of construction techniques and specific information regarding the use of concrete, refer to Annex 14.

### *Reinforced concrete slab*

There are two models; in one piece or two pieces (which is more easily transported).

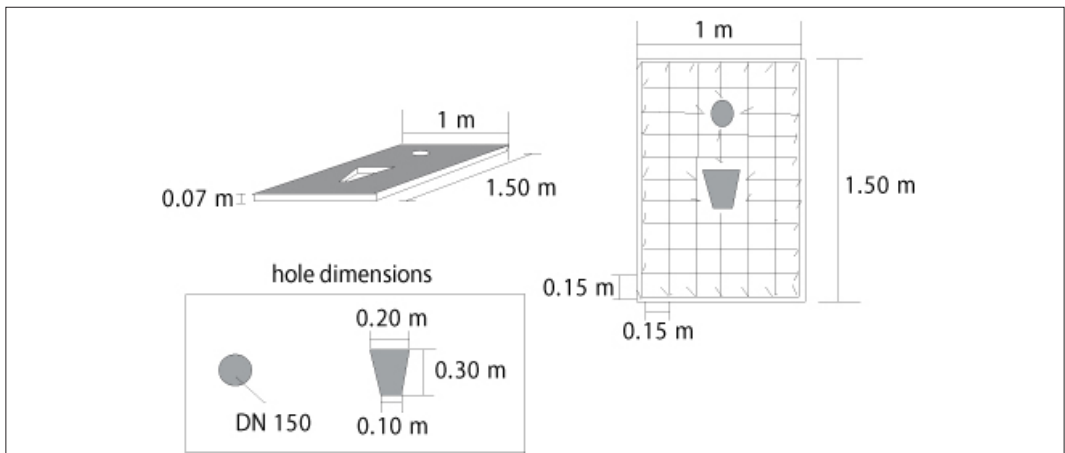
*Note.* – The hole in which the ventilation pipe is installed may be made using a piece of pipe that is removed a few hours after pouring the concrete.

### *Unreinforced concrete slab*

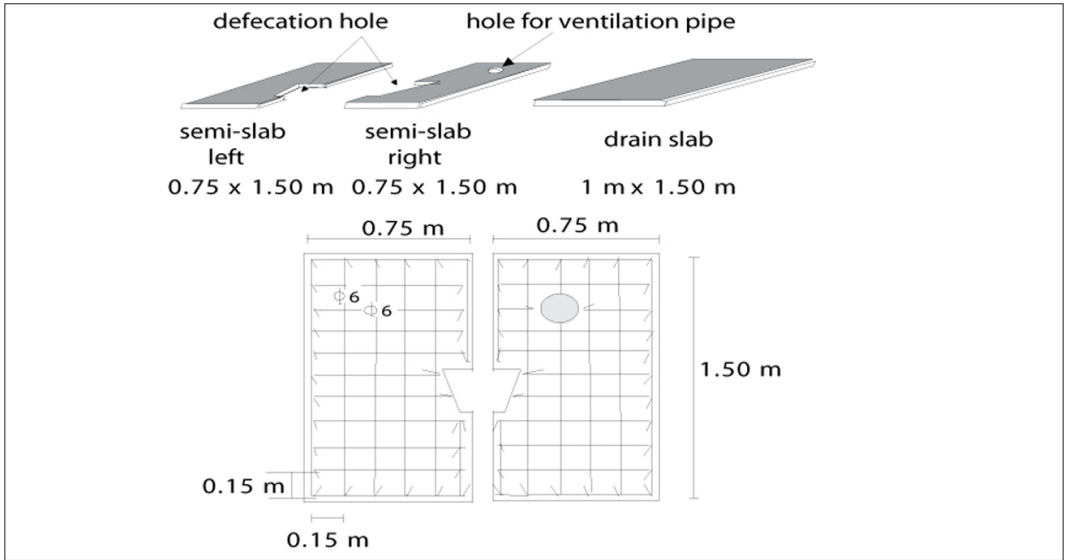
Unreinforced concrete slabs do not require steel reinforcement, so are cheaper.

**Table 13.VI: Characteristics of latrine slabs.**

Type of slab	Width (m)	Length (m)	Thickness (cm)	Cement bags 50 kg	Steel 6 mm (m)	Weight (kg)
2-part slab (1/2 slab)	0.75	1.5	7	1/2	21	210
1-part slab or removable slab	1	1.5	7	3/4	26	275



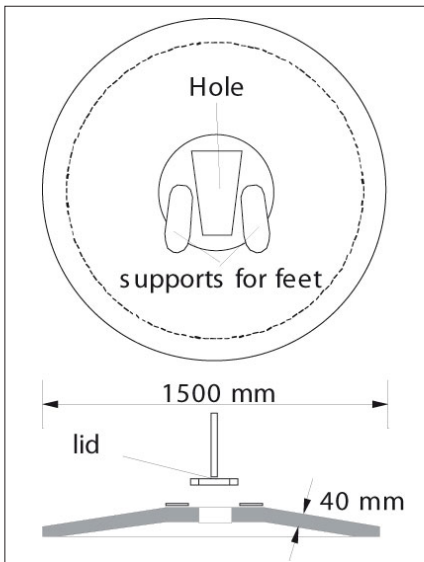
**Figure 13.5: Reinforcement for a single slab.**



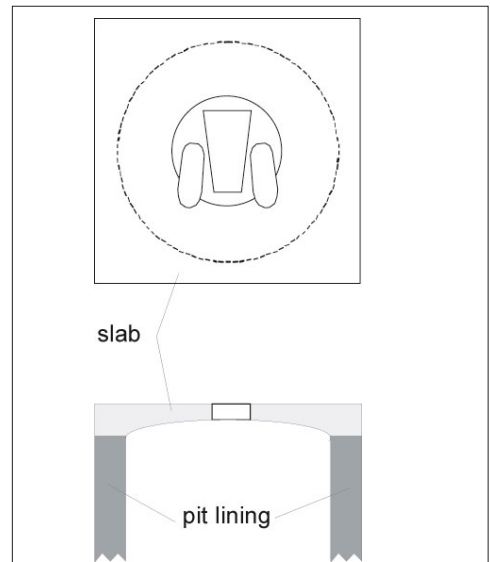
**Figure 13.6: Reinforcement for a two-part symmetrical slab.**

The best design of unreinforced slab is the domed slab as in Figure 13.7. The shape of this slab means that its underside remains in compression, which concrete resists better than tension. The concrete mix used for this type of slab must contain more cement than usual. The proportions should be: 1 part cement, 2 parts sand and 1.5 parts gravel (6-10mm). Two designs are used, one circular (Figure 13.7) and one rectangular (Figure 13.8). Unreinforced slabs are more fragile than reinforced ones, and more difficult to transport, especially the circular slab.

*Note.* – The unreinforced concrete slab does not include a second hole to accommodate a ventilation pipe (VIP type), so the design must include a cover for the defecation hole to control flies and odours.



**Figure 13.7: Round dome-shaped slab.**



**Figure 13.8: Rectangular dome-shaped slab.**

#### 4.2.3.4 The superstructure

The purpose of the superstructure is to provide privacy and an acceptable environment for the user.

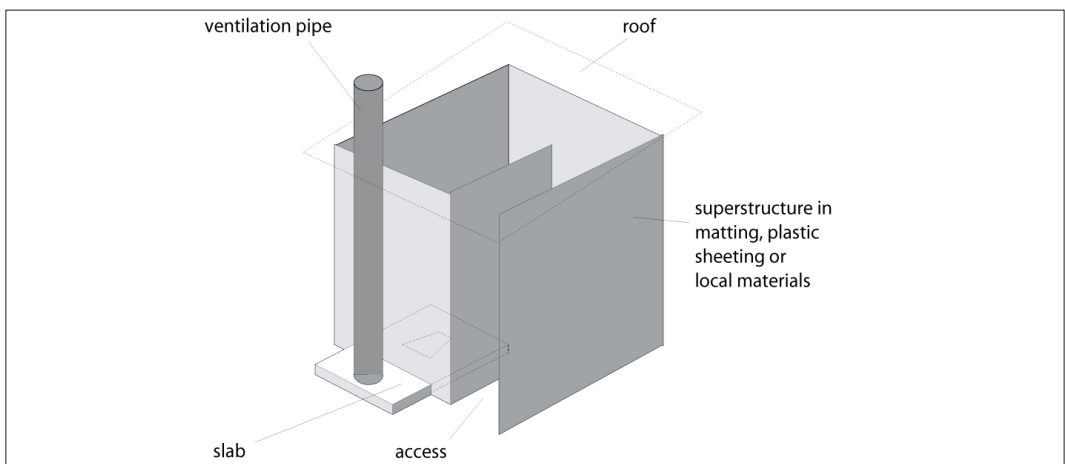
The superstructure may be one of several different shapes (rectangular, circular, spiral etc.), and its characteristics will depend on local construction habits, on the latrine design and on its design life. Many sanitation projects leave the design and construction of the superstructure to the user. The design must be defined with the users and will depend on their capacity for construction (factors that include money, time, materials etc.)

From a technical point of view, few design points need to be considered: the roof can provide privacy as well as being important for protection against rain, and the door is an important factor for privacy and security (with the ability to lock). The VIP latrine superstructure must additionally guarantee darkness inside the superstructure and the entrance of air.

##### 1) Particular models

###### *Spiral-shaped structures*

Although these superstructures (Figure 13.9) do not have doors, the interior is kept partially dark, which is an advantage for the VIP latrine, and it also reduces the faecal-oral transmission risk from hand contact with doors. This model is useful for public VIP latrines, for example, at schools where it is difficult for children to keep the door closed. The disadvantage is that it allows the free access of small children and animals, and the community must be vigilant about this. The spiral shape might require more materials for the walls than a simple design, but savings in materials or money are made due to the absence of the door, which is often expensive.



**Figure 13.9: Spiral-shaped superstructure.**

###### *Reusable structures*

A mobile structure is appropriate where there are no limitations of space and when the community is independent and motivated to build latrines. When the pit fills up the owner simply has to dig a new pit and to reinstall the old superstructure (including the slab) over the pit.

#### 4.2.4 USE AND MAINTENANCE

Daily maintenance is limited to cleaning the slab and superstructure. For simple pit latrines, the hole needs to be covered always when the latrine is not being used. For the VIP latrine, the door

Box 13.3

Guatemala, Jutiapa 1999. Construction of ventilated latrines with reusable structure.

The latrines were built for communities affected by Hurricane Mitch. The model of ventilated latrine chosen allowed the entire structure, including the slab, ventilation pipe and superstructure, to be transported. This addressed the problem of pits filling up. The superstructure was fixed to a welded metal or wooden frame in order to facilitate reuse.



Figure 1: Transport of the latrine.

Figure 2: Slab support and pit.



must be kept closed, the mesh on top of the ventilation pipe needs to be checked for holes, and water must be poured down the ventilation pipe once a year to remove spiders' webs.

The emptying of the pit is usually a task that is difficult for users to undertake, often for cultural reasons, and also because it can create health risks when not carried out by specialist personnel with adequate training and protective equipment.

The filling and emptying cycle of a latrine depends on the size and type of the pit, the number of users, the rate of decomposition and the nature of the soil. Normally pits should be sized to be emptied every 4 to 6 years, which allows the adequate decomposition of excreta.

The emptying of pits containing fresh excreta presents significant problems due to active pathogens present in the sludge. This problem is managed differently in rural and urban areas:

– *In rural areas*, where there is land available, it is advisable to dig another pit for a new latrine. The original pit can be covered and the buried excreta will not cause any health risk. After 2 years, the excreta will no longer pose any health problems and the pit can be emptied and reused, with the excreta used as a fertiliser (see Section 4.5).

– However, *in urban areas*, where there is no space to dig new pits, the double-pit system, comprising two small pits used in rotation is preferable. Another solution, if there are no risks of water contamination, is to build very deep pits, which significantly increases the life of the latrine.

Manual pit emptying should be avoided, or carried out with adequate protection for workers, to minimise the risk of contamination with pathogens from the fresh faeces.

It is also possible to empty pits using a desludging pump (note that membrane pumps are more appropriate than mud pumps or dewatering pumps) and a sludge tanker to transport the sludge to an



appropriate place for disposal. It is important to for the sludge to be in a liquid form (it may need to be wetted and stirred) and to avoid the presence of plastic materials, wood, stones or other solid elements in the sludge. It is important to promote this message in the community in order to avoid these materials being thrown into latrine pits.

Sludge emptied from latrine pits is loaded with pathogens, and therefore the disposal site should be chosen with care. It should be isolated from the community, and should be a dedicated sanitary site such as a landfill or a sewage-treatment works.

### 4.3 Pour-flush latrines

#### 4.3.1 THE PRINCIPLE

The pour-flush latrine is the most effective system to avoid bad smells and the proliferation of flies and mosquitoes, by keeping the pit isolated from the exterior. This latrine includes a water seal at the extremity of the pan (or bowl) in which the excreta is deposited. The seal remains full of water and guarantees that the pit is isolated.

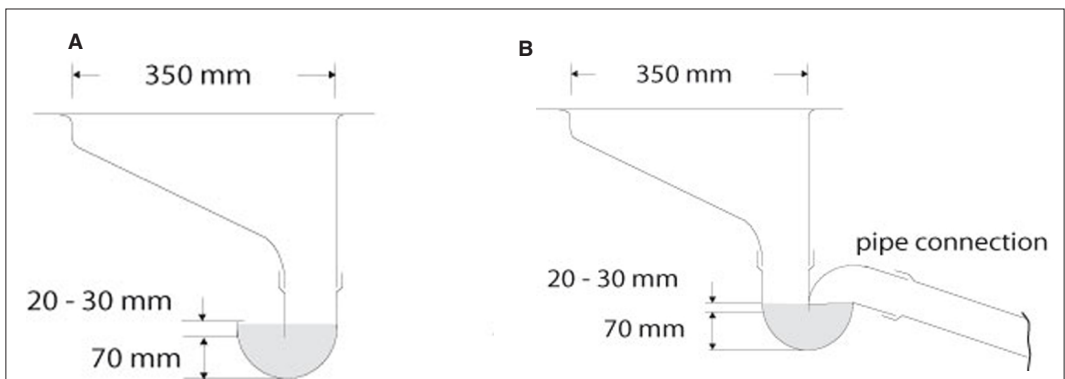
This system requires water on a permanent basis, both for cleaning the pan and for maintaining the seal (between 1.5 and 2 litres minimum for each flush). Therefore, this solution is only applicable where the availability of water is guaranteed.

#### 4.3.2 CONSTRUCTION

The major difference between wet and dry latrines is the use of water and the water seal, and the connection to specific pits. Therefore, only these aspects of wet latrines are more fully explored, below.

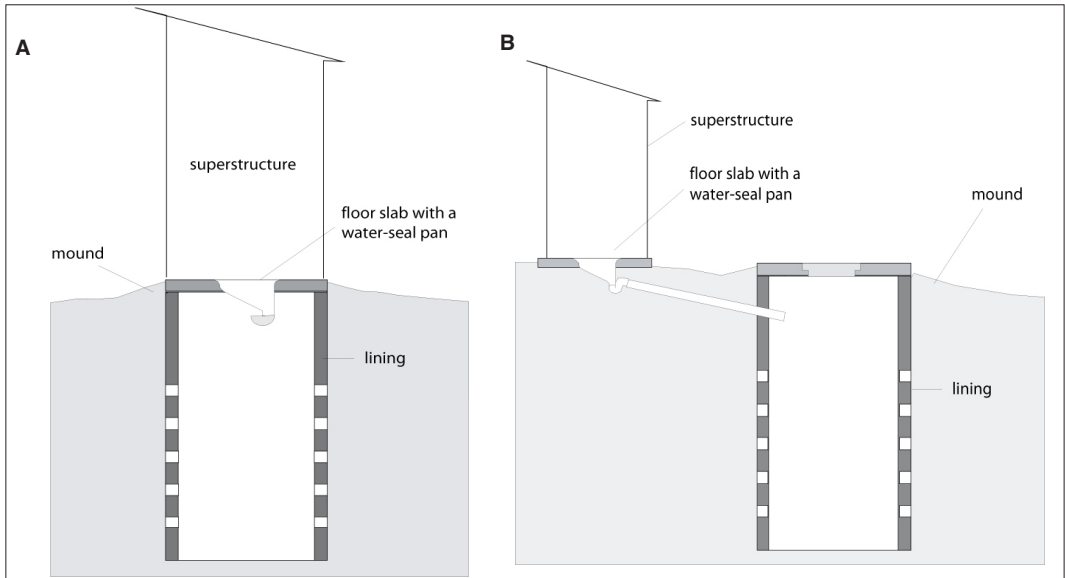
*Water seal* (Figure 13.10): in many countries it is possible to find the pan and the seal at reasonable prices. They can be made out of different materials including plastic, Plexiglas, high-density polyethylene (HDPE) or ceramics. It is also possible to make them in cement using a mould, if they cannot be purchased in the local market.

The use of water is an important factor when designing the pit, since it increases the volume of material that enters the pit. Where the soil is permeable it is possible to build a simple permeable pit, or even better, a septic tank, from where the effluent infiltrates into the soil. It is necessary to take care to prevent contamination of neighbouring water points (see Section 3.5). Where the soil is less permeable, the pit will fill up faster and hence there is a need to plan and organise emptying of the pit or construction of a new pit.



**Figure 13.10: Water seal.**  
**A: placed over the pit. B: with an off-set pit.**





**Figure 13.11: Latrines with water seal.**  
**A: set on top of the pit. B: with an off-set pit.**

The superstructure can be built over the pit (Figure 13.11.A), but the pan can also be set away from the pit, as the excreta can be carried by water in a connecting pipe (Figure 13.11.B). This is an advantage as it allows the toilet to be inside the house with the pit outside, and the latrine is more durable (when the pit fills up, it is sufficient to dig a new pit nearby and to remake the connection to the pan).

Where the pit is set away from the superstructure (Figure 13.11.B), more water is needed to carry the excreta, and obstructions can occur more frequently.

The diameter of the pipes or channel must be at least 75 mm and pipes must be laid along a straight line, as elbows or sharp curves can obstruct the flow and are more easily blocked. The least expensive pipes that can be used in this system are non-pressure drainage pipes. The minimum slope should be 1 / 30 for smooth pipes or 1 / 15 for rough pipes or channels.

*Note.* – In areas where there is a dry season in which water is scarce, it is possible for latrines over pits (Figure 13.11.A) to be designed in such a way that the water seal can be removed and a ventilation pipe can be fitted during the dry season, to create a VIP latrine.

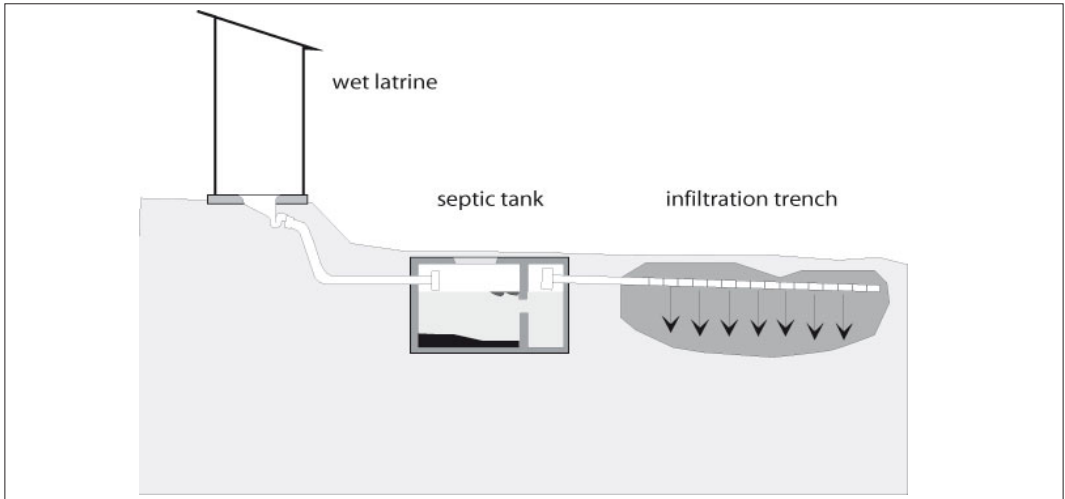
### 4.3.3 SEPTIC TANK

#### 4.3.3.1 The principle and its limitations

The septic tank is a waterproof underground tank that receives wastewater (‘black-water’ from toilets and / or ‘grey-water’ from cooking, bathing and laundry). It is the optimal on-site solution for toilets that function with water (Figure 13.12).

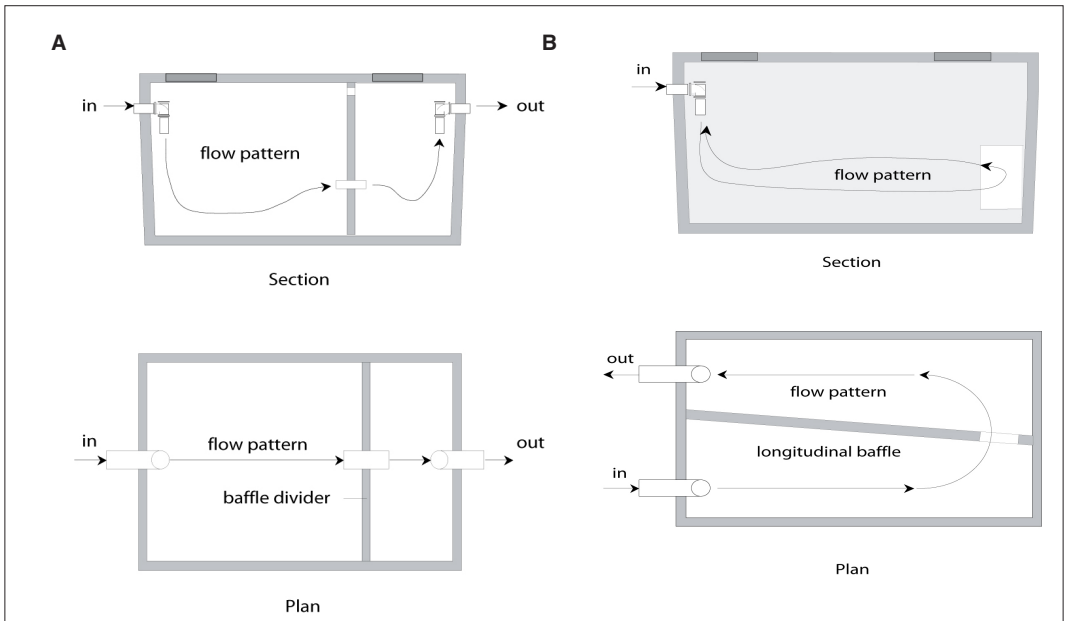
The septic tank comprises two chambers that are filled by wastewater that is transported via a pipe or channel, or falls directly from the latrine water seal. The wastewater is separated into sludge, liquid and scum within the septic tank, and this effluent undergoes different chemical and physical transformations before part of it exits the tank.

The septic tank is divided in two chambers, separated by a perforated partition wall or baffle (Figure 13.13).



**Figure 13.12: General view of wet toilet, septic tank and infiltration system.**

*The first chamber* is the larger chamber where wastewater arrives and where the sedimentation and compaction of solids occurs. A thick layer of scum often forms on the liquid's surface here, due to grease, oil, soaps, detergents and other chemical products. In some cases it is preferable to install a grease trap before the tank to reduce the amount of products that reach the septic tank. Anaerobic processes, where bacteria decompose the organic matter in the wastewater, producing methane and carbon dioxide, occur in this chamber. The ideal temperature for this is 35° C. It is important to make sure that pesticides, antiseptic agents or chlorine, that prevent these digestion processes, are not present in the waste water.



**Figure 13.13: Septic tank flow pattern (adapted from Crites & Tchobanoglous, 1998).**  
**A: interior baffle placed across tank. B: interior baffle placed longitudinally.**

The second chamber is connected with the first in such a way that only liquids move between the two chambers. The decomposition process and production of gases continue. This chamber has an exit for the passage of liquid out of the tank. It is usual to install an elbow or a tee at the outlet, to ensure that effluent comes from below the scum layer and is grease-free.

The liquid effluent will leave the tank after a usual retention time of 1 to 3 days, allowing the removal of up to 80% of suspended matter. There are three alternative destinations for the effluent:

- further treatment, with direct connection to a sewerage system;
- infiltration in the soil (see Section 4.3.6);
- reuse for agricultural activities.

Septic tanks require certain conditions to ensure proper operating, therefore domestic wastewater treatment by a septic tank can be considered if:

- sufficient water is permanently available for washing the excreta from the pan down to the tank (>40 l/pers/d for all uses WELL/WEDC 1998);
  - it does not affect priority water uses, such as drinking, cooking, personal hygiene, vegetable garden watering;
  - the soil environment is suitable for tertiary treatment through infiltration and there is no risk for groundwater contamination;
  - there is sufficient land available for a system for each family (about 8 m<sup>2</sup> for the tank and about 30 m<sup>2</sup> for the infiltration system);
  - a desludging facility exists (private or public) and users can afford the service cost;
- Septic tanks are particularly appropriate when anal washing by water is a cultural habit.

#### 4.3.3.2 Design of a septic tank (adapted from Franceys, Pickford & Reed, 1992)

The efficiency of the tank, and its design, depend on the wastewater retention time in the tank, on the entry system, on the water evacuation system and on the frequency of desludging the tank.

The volume of the tank can be calculated with the following formula (assuming that the retention time of the wastewater is 1 day):

$$V = A + B \text{ litres}$$

where A is the volume required for liquid retention and B is the volume required for sludge and scum accumulation.

– If a 24-hour retention time is chosen, then:

$$A = P \times q \text{ litres}$$

where P = number of persons using the septic tank, q = 90% of the daily water used per person (litres), if the tank is to receive black-water and grey-water, or q = estimate on the basis of the quantity required to flush the pan, the average number of users and the average number of flushes per user per day, if it is assumed that the tank will only receive black-water.

– The volume of sludge and scum (B) is:

$$B = P \times N \times F \times S$$

where P = number of persons using the septic tank, N = number of years between desludging, F = design factor (see Table 13.VII), S = accumulation rate for sludge and scum (in litres per person per year, e.g. 25 litres per person per year for black-water only).

The following rules are used to determine the shape of the tank:

- the depth must be at least 1.80 m, with the outlet at least 0.3 m below the cover slab;
- the width should be at least 0.6 m, since this is minimum space in which a person is able to work (building or cleaning the tank). Some codes and practices recommend the length to be 2 to 3 times the width;

– for a tank of width  $X$ , the length of the first compartment should be  $2X$  and the length of the second compartment should be  $X$  (Figure 13.14). Normally, the depth shall not exceed the total length.

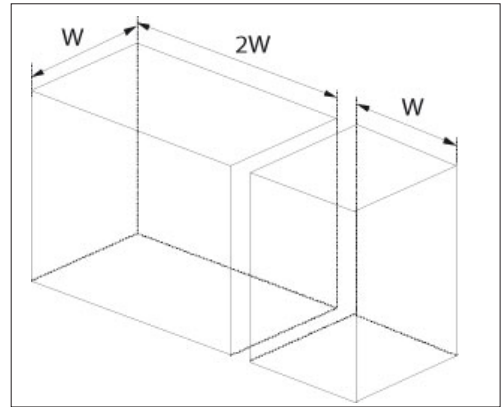


Figure 13.14: Design of the septic tank.

Table 13.VII: Values of the septic tank design factor  $F$ .

Number of years between desludging	Value of $F$ ambient temperature		
	$> 20^{\circ}\text{C}$	$> 10^{\circ}\text{C}$	$< 10^{\circ}\text{C}$ during winter
1	1.3	1.5	2.5
2	1.0	1.15	1.5
3	1.0	1.0	1.27
4	1.0	1.0	1.15
5	1.0	1.0	1.06
6 or more	1.0	1.0	1.0

#### 4.3.4 AQUA-PRIVY

The aqua privy is a variation of a septic tank that has only one chamber. It consists of a water-tight tank placed immediately below the latrine (Figure 13.15). Excreta falls directly into the tank via a pipe which is submerged in the liquid in the tank, forming a water seal that prevents flies and mosquitoes from escaping, and preventing smells. The level of liquid in the chamber must be kept stable for anaerobic digestion to take place. The tank functions in a similar way to a septic tank. The effluent from the tank normally infiltrates into the soil via a soakaway pit.

The regular removal of sludge from the tank is essential for it to function correctly. For this purpose, it must be possible to open the lid of the tank. In some cases, the installation of a ventilation pipe, covered with mosquito mesh, is recommended in order to evacuate gases and minimise smells. The tank should have a volume of at least  $1\text{ m}^3$  in order to avoid turbulence that prevents sludge sedimentation.

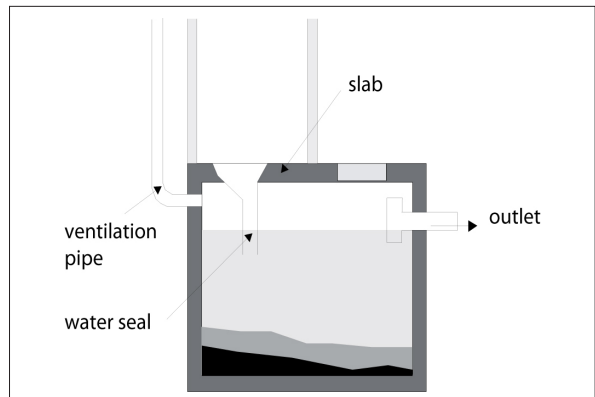


Figure 13.15: Aqua-Privy.

#### 4.3.5 USE AND MAINTENANCE

Pour-flush latrines need the same daily maintenance as dry latrines. This consists of cleaning the superstructure, the slab and the pan. The water seal must be kept constantly maintained with water in order to function properly.

Septic tanks must be desludged regularly in order to function properly. They should be emptied when the level of solids is almost at the level of the bottom of the connection to the second chamber. If the solids are not removed by the end of the design period, the amount of solids will decrease the available volume to retain wastewater sufficiently long for adequate settling, flotation and stabilisation.

The septic tank is emptied by a vacuum tanker or a sludge pump connected to a sewage tanker. The sludge, which is contaminated with pathogens, should be treated at a sewage-treatment works or dumped into a sanitary landfill site isolated from the community.

*Note.* – When desludging, it is advisable to leave a layer of sludge at the bottom of the tank in order to restart biological decomposition.

#### 4.3.6 DISPOSAL OF SEPTIC-TANK EFFLUENT

A septic tank is simply a combination of a retention tank and an anaerobic digestion chamber. The outflow of the tank is essentially equal to the inflow (except for some minor losses through removal of solids, filtration and evaporation, but this is not very representative). Even if the efficiency of the removal of suspended solids is good, the effluent will still contain a high concentration of pathogens and it is necessary to dispose of it in a safe manner.

Effluent can be disposed of by:

- direct infiltration in the ground, with discharge into soakaway pits (Figure 13.16) or trenches;
- recycling for agricultural uses (Box 13.4) after a pre-treatment process;
- a sewerage system that collects and treats effluent, where infiltration is not effective or where there is a risk of groundwater contamination.

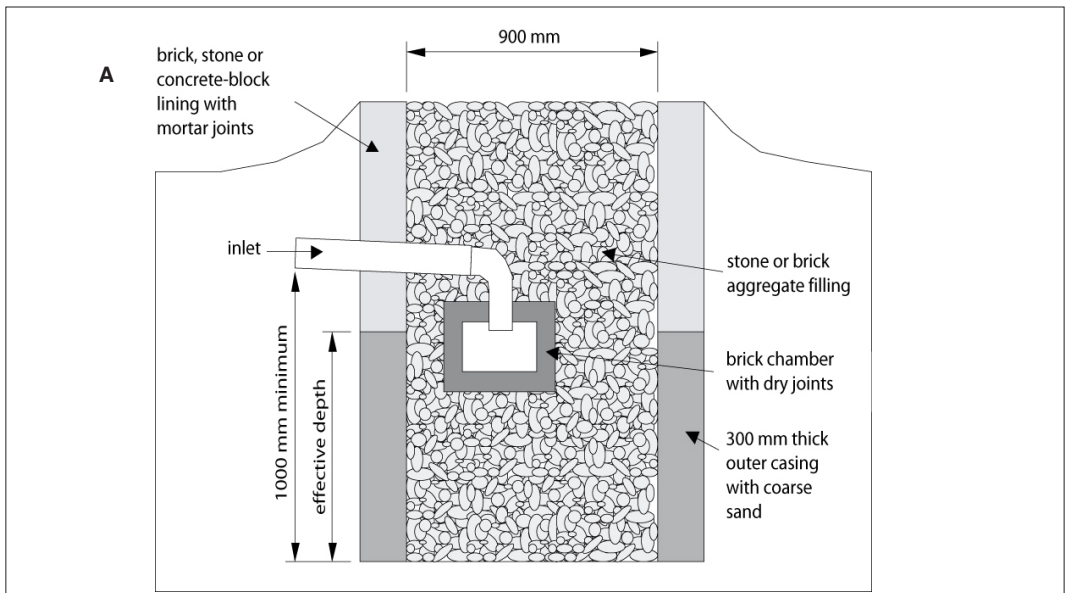
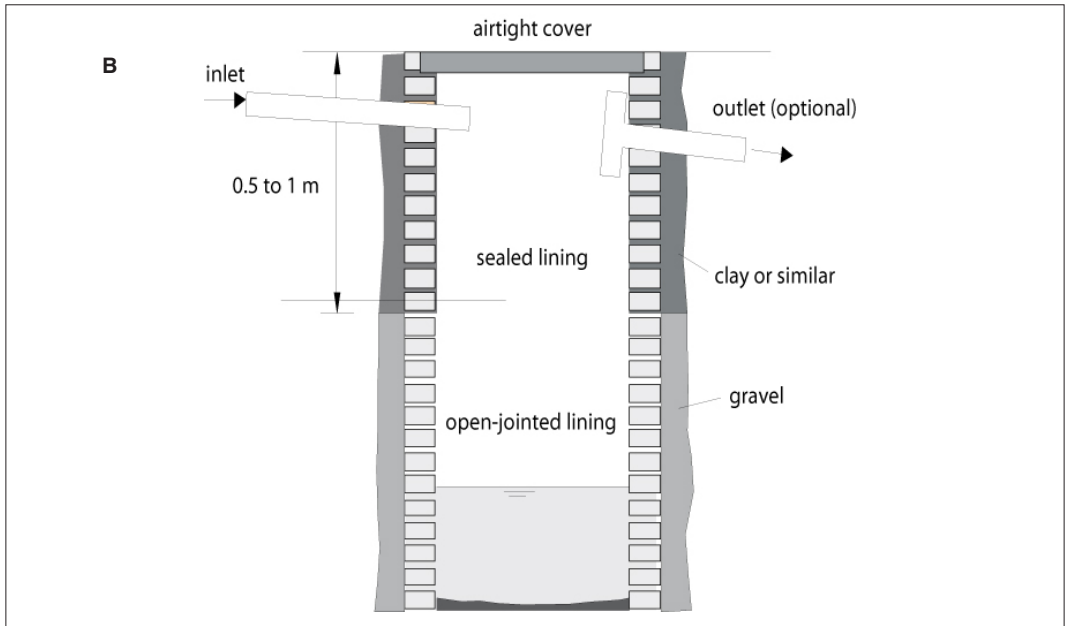


Figure 13.16: Soakaway pits. A: unlined pit.



**Figure 13.16: Soakaway pits. B: lined pit.**

*Soakaway pits* are a common method used to dispose of the effluent of septic tanks that serve individual houses. They are usually 2 to 5 m deep, with a diameter of 1 to 2.5 m. The volume should be at least equal to that of the septic tank. The cover can be made of reinforced concrete and may be buried 200-300 mm deep in order to avoid the entry of insects.

The area required for the infiltration should be calculated using the infiltration data for different types of soils and the flow rate of the water to be treated (Box 13.5).

- *Unlined pits* (Figure 13.16.A) are filled with stones or broken bricks larger than 50 mm in size. If the main part of the pit is filled, the upper 50 cm should have a protection ring made out of blocks, bricks, or reinforced concrete in order to provide a standing support to the cover. The ring can be dome-shaped in order to reduce the size of the cover.

- *Lined pits* (Figure 13.16.B) are usually built with bricks, blocks, or cast concrete, as with latrine pits, and the infiltration capacity may be increased by filling the space between the lining material and soil with sand and gravel.

#### Box 13.4

##### Reuse of effluent.

Wastewater is too valuable to be thrown away in semi-arid and arid areas, and may be reused for farming (or to raise fish).

The use of wastewater for irrigation improves crop production, as it provides both moisture and nutrients (mainly nitrogen and phosphorous) that are beneficial for plants.

However, wastewater should be treated to eliminate or at least reduce the level of pathogenic contamination that poses human health risks. WHO recommends that for irrigation, except for those vegetables that are eaten without cooking, which should not be irrigated with wastewater, the treated wastewater should not contain more than one nematode egg per litre and no more than 1 000 faecal coliforms per 100 ml.

*Infiltration trenches* are an effective alternative to soakaway pits. This system consists of a 10-cm diameter pipe installed in a 30-50 cm wide and 60-100 cm deep trench which is filled with gravel (2-5 cm in diameter), then an impermeable layer to stop soil washing into the gravel, covered with soil to avoid erosion. The recommended slope of the trench 0.2 to 0.3%.

**Box 13.5**

Experimental values of the infiltration capacity of different soils.

The way water infiltrates into the soil depends on the type of soil. Clay will expand with humidity and make the soil impermeable. Silts and fine sands are sufficiently permeable to drain the water but they will become impermeable when the wastewater contains a high concentration of solids. Soils that have a large porosity allow water to drain easily and include sands, gravels, and fractured rocky soils. Organic soils have a large capacity to retain water. However the roots of trees and other plants create fractures in the soil through which water easily drains.

Type of soil	Infiltration rate of settled sewage (litres/m <sup>2</sup> /day )
Coarse to medium sand	50
Fine sand, loamy sand	33
Sandy loam, loam	25
Porous silty clay and silty-clay loam	20
Compact silty loam, compact silty-clay loam and non-expandable clay	10
Expandable clay	< 10

Source: US Environmental Protection Agency, 1980

The useful infiltration area (Si) is given by:

$$S_i = \frac{\text{volume of the effluent (l/day)}}{\text{infiltration rate (l/m}^2\text{/day)}}$$

The length of the infiltration trench is therefore equal to:

$$L \text{ (m)} = \frac{\text{infiltration area } S_i \text{ (m}^2\text{)}}{2 \times \text{depth of trench (m)}}$$

## 4.4 Advantages and disadvantages of simple, VIP and pour-flush latrines

**Table 13.VII: Advantages and disadvantages of simple, VIP and pour-flush latrines.**

Advantages/Disadvantages	Simple latrine	VIP latrine	Pour-flush latrine
<i>Construction</i>			
Simple technology	+++	++	+
Low cost (use of local materials possible)	+++	++	+
Construction time	+++	++	-
Potential for improvement	-	Possible upgrade to pour-flush latrine	Possible connection to a sewerage system
<i>Use &amp; maintenance</i>			
No necessity for water	+++	+++	-
Easy to use	+++	+++	-
(efficiency of the system independent of its correct utilisation)		The interior needs to be dark	Water must be provided and used
Maintenance	++	++	+++ +*
Adaptation to type of anal cleansing	++ Adapted to water cleansing if plastic or concrete slab is installed and if soil conditions allow	++ Adapted to water cleansing if plastic or concrete slab is installed and if soil conditions allow	Possible blockages when solid materials are used
<i>Hygiene &amp; comfort</i>			
Privacy	+ Latrine far from house (bad smell)	++ Latrine near the house	+++ Latrine inside the house
Absence of smell	+	++	+++
Fly control	-	++	+++
Mosquito control	-	+	+++
Hygiene	+++ If correctly designed, built, used & maintained	+++ If correctly designed, built, used & maintained	+++ If correctly designed, built, used & maintained
Pleasant to use	Pit is visible	Pit is visible	+++

\* Impermeable soil.

## 4.5 Composting latrines

### 4.5.1 ADVANTAGE AND DISADVANTAGES

Composting latrines allow the reuse of excreta for agriculture. This system has advantages and disadvantages summarised below (Table 13.VIII).

**Table 13.VIII: Advantages and disadvantages of composting latrines.**

Advantage	Disadvantage
Fertilisation of fields	Requires consistent use and maintenance, or the system fails and can cause sanitary risks
Income-generating activities	Many communities will not accept the system
Regular emptying of latrines permits their construction in rocky or high water-table contexts where deep pits cannot be dug	
Composting process kills pathogens	



This technology is only introduced into areas where compost is already used, because the introduction of the composting system is difficult if people do not have previous experience, and the management of such a latrine is time-consuming and requires constant effort.

It must be clearly established that the community will be interested in using or selling compost and that they will be ready to handle excreta, before implementing a composting-latrines programme. This assessment should include a market study. The introduction of this system into a new area should be preceded by a pilot programme with the participation of one or several volunteer families. The programme can be expanded according to the demand of the community, with positive results from the volunteer families.

#### 4.5.2 COMPOSTING PROCESS

The composting process, facilitated by composting latrines, is an aerobic biological process that stabilises (dries and disinfects) excreta mixed with organic elements (leaves, paper) and inorganic elements (ash, soil) to produce a humus-like product that can be used as a soil additive. This product can be used by the community, or sold, after about four to six months.

An important characteristic of composting latrines is their ability to separate urine from excreta, to enhance the composting process and produce compost that is easy and safe to collect.

Urine can be stored in a jerrycan and used as a nitrogen-rich fertilizer, or diluted to use as an insecticide or fungicide to treat plants.

Three types of composting latrines implemented by ACF are presented in the following section.

#### 4.5.3 EXAMPLES

##### 4.5.3.1 LASF Composting latrine in Guatemala

###### *Context*

The double-chamber LASF latrine (*Letrinas Aboneras Secas Familiares* -Family Dry Composting Latrines) was first developed in the 1960's in Vietnam and then adapted to Guatemala in the late 1970's. It was later used in other Central American countries.

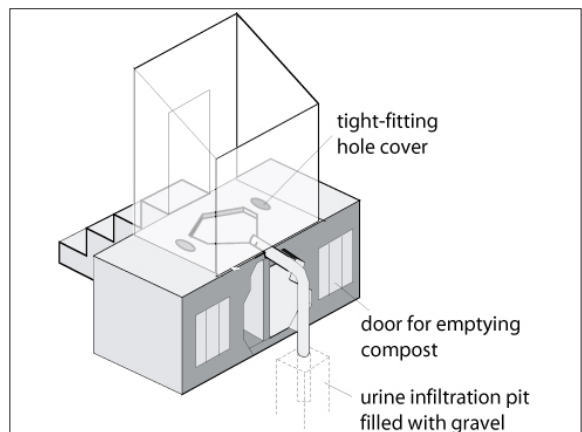
ACF carried out a LASF project between 2000 and 2002 (Table 13.IX) as part of a water and sanitation project for vulnerable farming communities in Western Guatemala.

The result of the programme was very positive, although it was implemented in a zone with no previous composting latrine experience. More than 95% of latrines were used, with 60% of the compost re-used after 1 year of operation.

###### *Design*

The design consists of an elevated latrine with a double chamber and a removable pan (Figure 13.17 & 13.18) that is not sealed to the slab, with access through the back wall.

The design must take into account the time it takes to fill up one chamber. Each one must therefore be sufficiently large to allow time for the complete decomposition of the excreta deposited in



**Figure 13.17: LASF design.**

the other one (see Section 4.2.3.2). In Guatemala the normal dimensions of each chamber are: 0.8 m x 0.6 m x 0.8 m = 0.4 m<sup>3</sup>.

Urine and excreta are not deposited together. The urine is directed to an external container, for reuse, or to a soakaway pit.



**Figure 13.18: LASF in Guatemala (ACF).**

**A: toilet pan (urine-excreta separation). B: emptying and storage of the compost.**

*Recommendations for use*

While one chamber is being used, the second is closed while the excreta that was deposited during the previous 6 months undergoes aerobic decomposition. Every 6 to 8 months, the chamber that is full of composted excreta is emptied into bags that are stored in a dry place, the emptied chamber is put into use, and the other is closed for decomposition.

Strong capacity building and sanitation education components must be included in a LASF project, as well as training in storage and use of compost.

*Treatment efficiency*

Analyses of compost have been made, with results summarised in Table 13.IX.

- It is recommended to add a nitrogen-rich additive to this compost (urea, horse-manure compost etc.), given its low nitrogen content.
- Pathogen removal is excellent. After 3 months in a dry environment the majority of pathogens have died.

**Table 13.IX: Average nutrient contents of 9 samples of human-excreta compost.**

Nutrient	g/kg	Percentage of nutrient in the total weight of compost	Relative percentage of each nutrient
N	7.8	0.8%	13%
P <sub>2</sub> O <sub>5</sub>	16.5	1.6%	27%
K <sub>2</sub> O	37.3	3.7%	61%

#### 4.5.3.2 Composting barrel latrine in El Salvador

##### Context

Oxfam in El Salvador designed a new version of the traditional composting barrel latrine in order to reduce the time and space needed for construction, and implemented this design in the country during the rehabilitation phase after the earthquake in 2001. ACF adopted this design in its El Salvador programme in areas where it had been already used.

Barrel latrines have three main advantages:

- excreta can be transported inside the barrels, which decreases the risks during handling and improves acceptance by communities;
- they accelerate the composting process;
- the barrel is inside the latrine pit with its upper part above ground level, which protects it from flooding.

##### Design

The latrine consists of a simple cabin over a 200-litre steel barrel (Figure 13.19) installed within the pit with only a 30-cm portion above the ground level. The barrel is equipped with a specially designed fibre-glass pan (double pan), with a 3” pipe for the evacuation of gas, and has four welded handles.

As for the LASF system, urine is guided toward the exterior through a flexible pipe to a soakaway pit.

##### Recommendations for use

Three people can remove the barrel when it is full (approximately every 3 months for a six-person family), and replace it with an empty barrel. The composting process continues in the first barrel, which is left closed, with a ventilation pipe, for 2 months in the shade or 2 to 3 weeks in the sun. Then the barrel is emptied onto the ground and the composted material is stored in bags in a dry, cool place.

##### Treatment process and efficiency

The treatment process is the same as for the LASF system, except that is accelerated by solar heating.

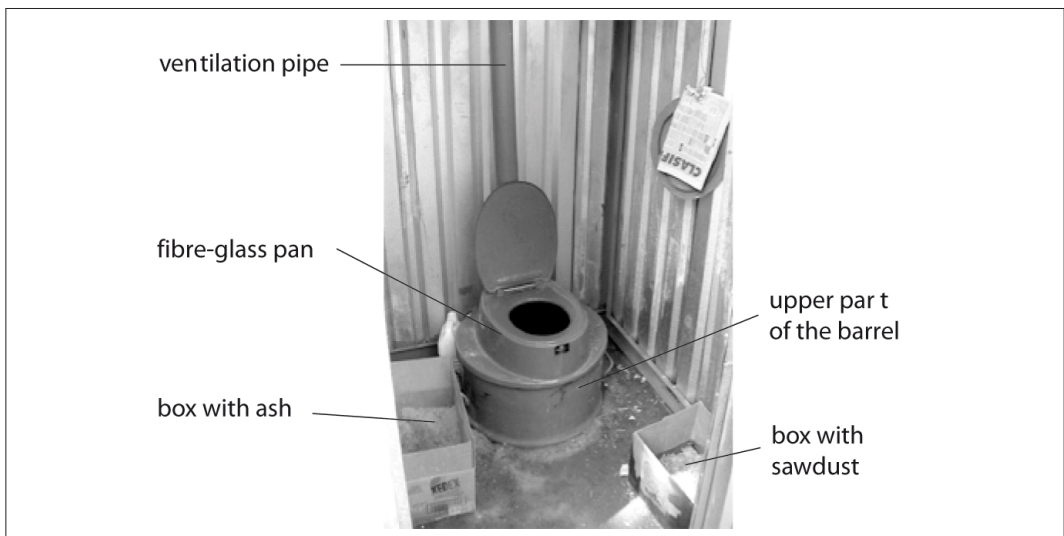


Figure 13.19: Example of composting barrel latrine (ACF, El Salvador).

#### 4.5.3.3 Vault latrines in Kabul

##### Context

The majority of private households in Kabul, as in many other parts of Afghanistan, normally use a traditional vault latrine. Here, farmers organise the collection of excreta directly from the vault latrines for off-site composting. The latrines were not maintained during the previous decades of conflict and had fallen into a state of disrepair. At the same time, the collection of excreta decreased, leading to a great deterioration of sanitary conditions in the city. Numerous agencies undertook the rehabilitation of these traditional latrines. ICRC improved the traditional design (reinforcing the construction and adding a urine-evacuation pipe as well as a door to close the pit), and ACF adapted this model as described below.

##### Design

The latrine is placed in the street next to the wall of the household compound. The vault of the latrine has an opening facing the street so that it can be emptied from the outside of the compound.

The improved model, designed by ACF, includes (Figure 13.20.A):

- a stone masonry vault with a concrete bottom, which protects the shallow water table, and a shallow soakage trench placed in the back that allows the percolation of liquids;
- a metal trap-door that allows excreta collection from the street;
- a reinforced-concrete slab whose design allows the separation of urine from the excreta, and the collection water from anal cleansing and slab washing (Figure 13.20.B);
- a ventilation pipe equipped with mosquito netting;
- a superstructure made of mud bricks; and
- a roof made of wooden logs, mud and straw.

Emptying must be done every 45 days, on average, based on ACF experience.

In 2003, this system cost approximately US\$200.

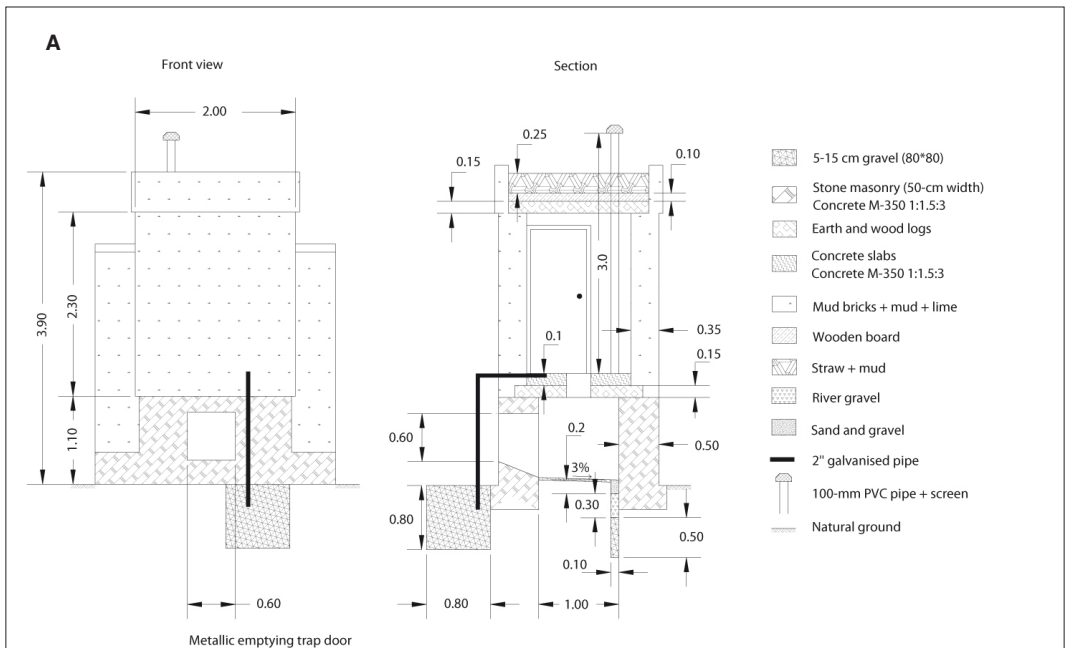
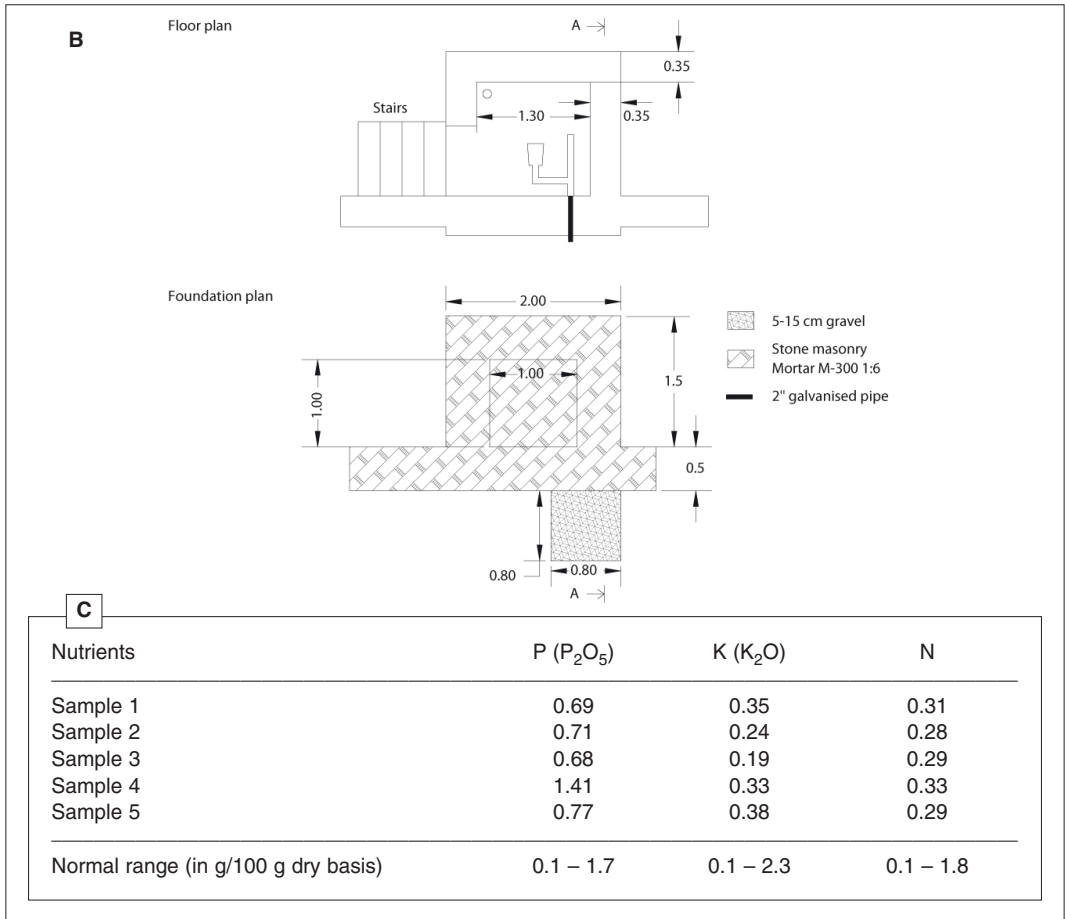


Figure 13.20: Vault latrine (ACF, Afghanistan). A: general design.



**Figure 13.20: Vault latrine (ACF, Afghanistan).**

**B: slab, separation between urine and excreta. C: concentrations of some major elements in the compost of Aqa Ali Shams vs. normal range for compost (source : Brunt et al. 1985).**

### *Design selection restrictions*

This system should only be considered where the collection of excreta is a normal practice, because these latrines have no long-term storage capacity. Otherwise, the vault will be full after one or two months and excreta will flow into the streets.

### *Recommendations for use, and general comments*

Traditionally, farmers from surrounding rural areas used to employ people to empty latrines and transport the excreta to their farms for compost production. The traditional excreta-collection system relied on a mutual free service: farmers received excreta at a low cost, and re-used it as fertilizer, while households had their latrines emptied for no cost. Further, this activity provided some income to those collecting and transporting the excreta.

Recently, the system broke down in many neighbourhoods of Kabul, because of:

- the increase in the urban population during the past two or three decades, that has decreased the area of farmland around the city and increased the number of latrines to be emptied,
- and the drought that has affected the region of Kabul since 1999, compelling many farmers to leave their land, and subsequently reducing the demand for fertilizer.

The main consequence of the deterioration of this system was that latrines in Kabul were no longer regularly emptied, leading to an increase in public health hazards.

To solve this problem ACF focused on the collection of excreta and the subsequent composting process. A partnership between an ACF-supported local neighbourhood committee and farmers from the area was established. The neighbourhood committee was responsible for the following:

- organisation of latrine-emptying and transport of excreta to farmers;
- purchase and provision of raw materials for compost production (including straw, sawdust etc.);
- composting of the excreta;
- storing and packaging of the compost for sale;
- sale of bags of compost to other farmers.

The farmers were responsible for the compost-production process, including the mixing of excreta with raw materials and regular turning of the mixture. ACF provided technical assistance, including training of farmers, choice of the composting recipes, and temperature monitoring of compost piles, and ensured the promotion of the compost for sale.

The aerobic decomposition process is more efficient in off-site composting than that in on-site composting latrines, because the material is repeatedly mixed and aerated.

With the assistance of the local population, ACF had rehabilitated more than 2 350 latrines in Kabul by the end of 2003.

## 4.6 Latrines for rocky and frozen ground, high groundwater levels and flood-prone areas

Latrine construction in rocky or frozen ground is difficult due to excavation problems. Special tools are required for excavation, such as chisels, sledge hammers, miner's bars or pneumatic hammers, and much effort and time is required to complete the work. Further, the low infiltration rate common in these terrains means that the pits quickly fill up. In these situations, it is preferable that the volume of pits is small and that pits are emptied frequently.

Latrine construction in areas with high groundwater levels is complicated because of contamination risks for groundwater, and consequently, nearby water points (see Section 3.5 on water-point contamination). Here, it is not always advisable to dig pits and use standard latrine designs.

Simple solutions have proven to be successful in these difficult contexts, as follows.

### *Double-pit latrine (for dry latrine or pour-flush system)*

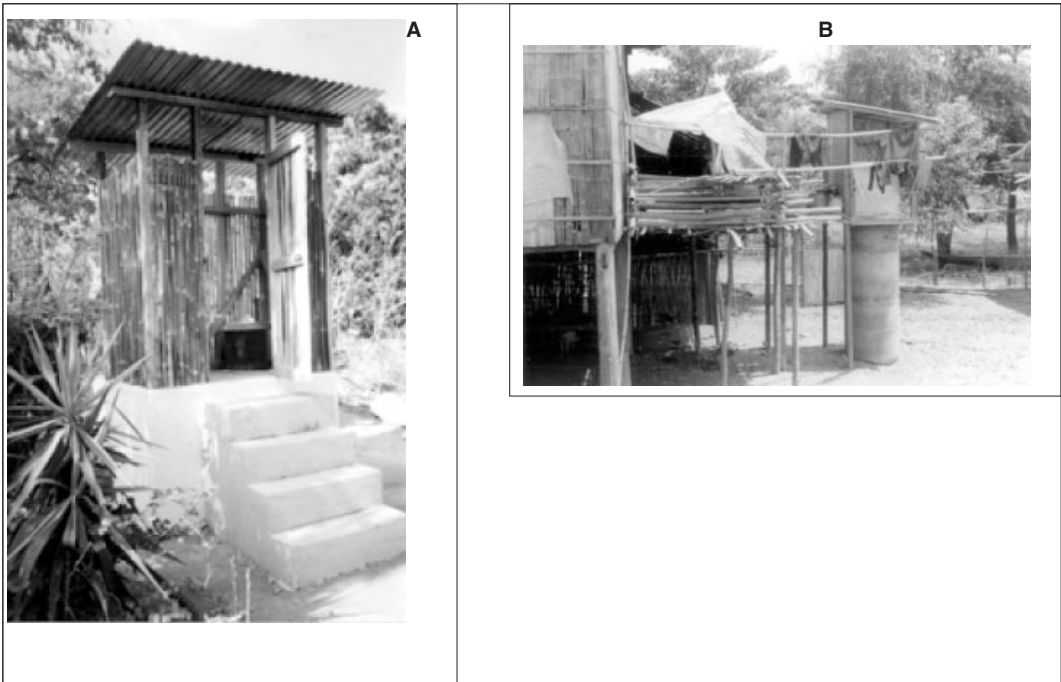
This design can be constructed in conditions where digging is restricted due to high groundwater levels or rocky ground, and also in non-problematic contexts, to increase the operational life of the latrine by making it easy to empty. The latrine consists of two relatively shallow pits, that can be built partially on top of the surface of the soil if digging is very restricted. When the first pit is full, the second, empty pit is used and the first, full pit is sealed. When the second pit becomes full, sufficient time (12-24 months) has passed for the excreta in the first pit to have undergone decomposition. The first pit is then emptied and is ready to be reused. Composted excreta can be thrown away or used as fertilizer (see Section 3.5).

### *Composting latrines*

Composting latrines are very suitable for these difficult contexts. Vault latrines, double composting chambers, or barrel latrines can be built without digging a pit (see Section 4.5). These systems are of particular interest if there is a market to sell (or use) the fertilizer produced by composting of the excreta, as this provides a financial incentive for the community to adopt a proper latrine system.

### *Elevated pit latrine*

For an elevated pit latrine in high groundwater areas (Figure 13.21), the pit is dug as deeply as possible during the final part of the dry season when the water table is at its lowest. The pit is lined



**Figure 13.21: Elevated pit latrine.**

**A: for high groundwater areas (ACF, Guatemala). B: for flood-prone areas (ACF, Cambodia).**

and protected to isolate it from the water-table that rises to the base of the pit during the wet season. The pit is extended above the ground level, until the required pit volume is achieved, through the construction of watertight walls or the use of large metal or prefabricated concrete bins placed into the pit.

Latrines built in *flood-prone areas* must be accessible even during floods, and also must prevent excreta from escaping from the pit and causing widespread contamination. Figure 13.21B shows an example of elevation of the pit through concrete rings that also protects the pit from water ingress.

#### *Bucket or barrel latrine*

The bucket latrine consists of a system where excreta is deposited in a bucket or a barrel that can be easily removed and emptied. This latrine requires a high level of sensitisation about its maintenance and emptying, given the potential sanitary risks. However, if it is used properly and has a safe emptying and disposal system, and is accompanied by an adequate maintenance and hygiene promotion programme, this can be an efficient system. This system requires daily cleaning and maintenance, with material inside the bucket or barrel deposited into a larger recovery tank, which in turn, is emptied on a daily basis at an appropriate treatment or disposal site.

## 4.7 Excreta control in IDP or refugee camps

Excreta control in these emergency situations must be implemented rapidly, as large concentrations of people create environments where the risk of epidemics (e.g. cholera and other diarrhoeas) is high and where people are very vulnerable.

The latrine design will evolve over different phases of the humanitarian response, in order to provide a quick and efficient intervention, from the first days of the emergency to the more permanent installation of the camp.



## Objectives / activities by phase

### Phase 1

- Identify areas where defecation generates sanitary risks (near water points, upstream from the camp for a river, near hospitals etc.) and control the access of people to these areas.
- Identify and delimit specific areas where people can defecate (defecation fields, Figure 13.22).
- Construct latrines at key public points: health centres, schools etc.

### Phase 2

- Emergency communal latrine construction and maintenance.

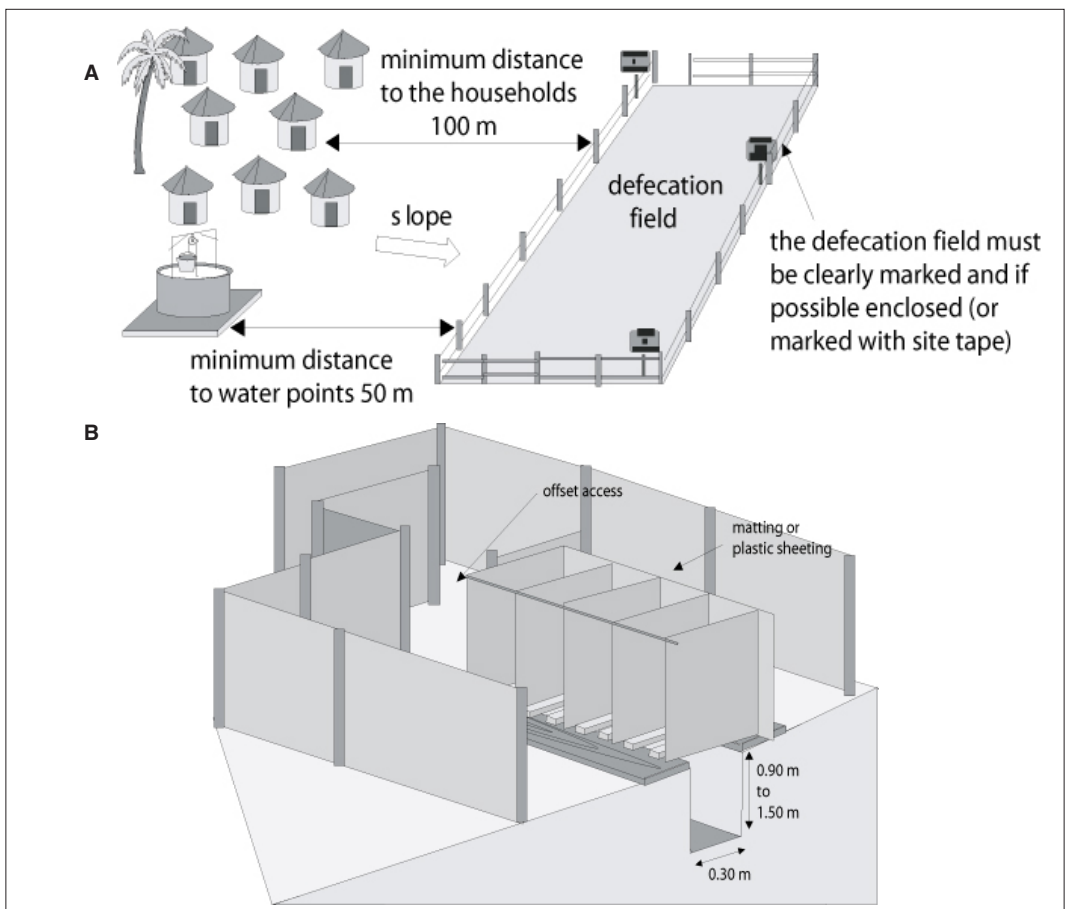
### Phase 3

- Family latrine construction

## 4.7.1 DEFECATION FIELDS OR TRENCHES

These installations, preliminary to the construction of latrines, allow the servicing of a large population quickly, decreasing the risk of propagation of faecal pollution (Table 13.X & Figure 13.22).

Defecation fields involve the delimitation of an area where people can defecate. They are more appropriate in dry places and dry climates because they are installed in open areas.



**Figure: 13.22: Defecation management in the first (acute) phase of an emergency.**

**A: defecation field. B: defecation trench.**



**Table 13.X: Characteristics and construction of defecation fields or trenches.**

Field area	< 5 m <sup>2</sup> /pers
Distances to be maintained	
field – dwellings	100 m
field – water point	50 m downstream from water point
Trench length	2.5 m / 100 people
Distances to be maintained	
trench – water point	30 m
trench bottom – aquifer	2 m
Materials (for a 10 m long trench)	5 boards (L = 4 m, W = 0.2 m) 21 posts (2.5 m long, 0.1 m dia.) Plastic sheeting (L = 36 m, W = 2 m) 1 kg 7-cm nails
Personnel	4 people for 1 day (trench)
Tools	2 shovels, 2 picks, 2 buckets (12 l) 10 m of 4-mm cord 1 frame saw, 1 machete, 2 carpenter's hammers
Implementation	Trench digging (length: 10 m, depth: 1.5 m, width: 0.3 m) Protection of trench edges with wooden boards Digging of holes for posts Erection of enclosure (plastic sheeting or matting) Possible partitioning for privacy

Defecation fields can be improved with defecation trenches, where faeces are buried, decreasing the health risks. These trenches can be shallow (20-30 cm wide and 15 cm deep) or deeper if tools and human resources available. Defecation trenches can be dug very rapidly, either manually or, when available, with a mechanical excavator.

Wooden boards or logs can be placed across the trench to support the weight of the user over the trench. It is also recommended to make compartments with plastic sheeting or local materials to allow the privacy.

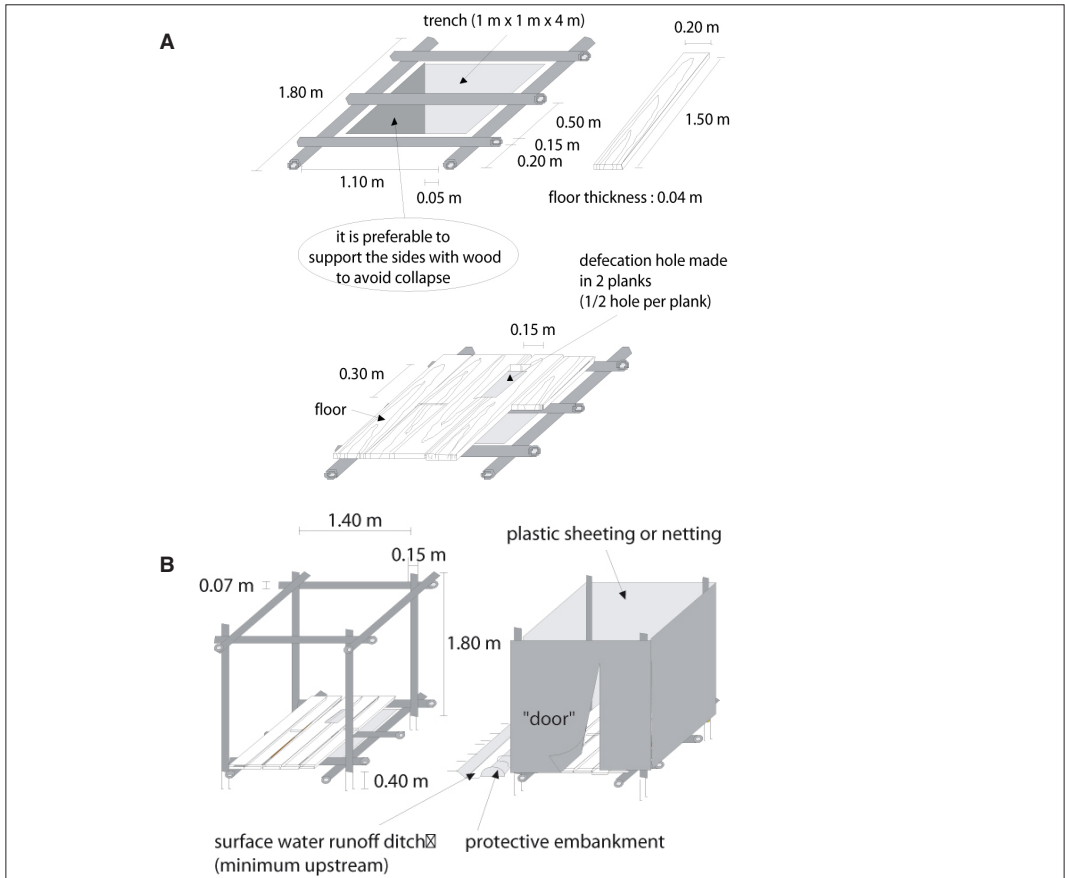
The faeces in the trench are normally covered daily with soil, to limit smells and fly infestation. Defecation trenches will fill rapidly, and new trenches will need to be dug every few days, depending on population numbers and the depth of the trenches.

Local representatives should be consulted to determine specificities regarding privacy, gender and children's issues, as these vary for different communities and cultures.

#### 4.7.2 SIMPLE LATRINES

Latrines with wooden slabs (Table 13.XI & Figure 13.23) are a rapid solution to sanitation needs in camps, and are often used during the construction of more permanent latrines. However, this latrine design is normally used at household level, as they are difficult to clean and maintain at a camp level. Hygiene promotion must be carried out, and paid cleaning teams are often necessary.

The use of plastic or metal slabs for simple latrines is an efficient way to intervene quickly in an emergency context. These slabs should be part of an emergency stock.



**Figure 13.23: Simple wooden latrines.**  
**A: trench and floor. B: superstructure.**

**Table 13.XI: Characteristics and construction of simple wooden latrines.**

Materials (1 x 1 x 4 m trench, supported by beams every 0.50m)	10 x 1.40 m timber for the support (0.10 m dia.) 9 x 2.20 m timber for the structure (0.15 m dia.) 4 x 1.60 m timber for the reinforcement (0.07 m dia.) 10 boards (W = 0.20 m, L = 1.5 m) Plastic sheeting (W = 1.80 m, L = 7 m) 2 kg of 7, 10, and 12 cm nails
Personnel	3 people for 2 days (1 carpenter and 2 assistants)
Tools	2 shovels, 2 picks (hoes), 1 bucket, 2 carpenter's hammers 1 saw, 1 measuring tape 10 m of 8-mm cord
Construction	Trench digging (1 x 1 x 4 m) Installation of timbers, embedded in the ground Fixing the floor with nails Erecting posts and fixing the plastic-sheeting walls Installation of a drainage system around the latrines

### 4.7.3 SEMI-PERMANENT OR PERMANENT LATRINES

If the displaced people remain in the camp for several months or more, semi-permanent or permanent latrines must be built in order to guarantee proper sanitation. Construction can be carried out with the assistance of, or wholly by, the camp residents, depending on the level of their motivation and the strength of the hygiene-promotion programmes (see Sections 3 & 4).

## 5 Other environmental sanitation activities

### 5.1 Personal hygiene structures

#### 5.1.1 FACILITIES FOR WASHING HANDS (AND ANAL CLEANING)

Washing hands is one of the most effective ways for the reduction of faecal-oral diseases. Water availability for this activity is absolutely necessary at the household level as well in public places where washing hands is a priority, for instance at public latrines or health posts. Washing hands is always important after defecation, even when water is used for anal cleaning, and latrines should be provided with facilities for washing.

For washing facilities, a connection can be made to an existing water-distribution system to create a water point. It is possible to create an independent water point where there is no piped water supply; for example, a well equipped with a handpump. Alternatively, small barrels or sealed containers, equipped with taps and containing chlorinated water, can be placed next to latrines, and offer a rapid and cost-effective solution. These are filled and maintained by the community on a daily basis. In all cases, adequate drainage must be constructed.

#### 5.1.2 SHOWER AND LAUNDRY AREAS

The provision of access to washing facilities, coupled with the availability of drinking water adjacent to these facilities, is fundamental to limiting water-washed diseases.

##### 5.1.2.1 Showers

Hygiene facilities have two main objectives: to support the promotion of safe hygiene habits, taking account of socio-cultural factors, and to reduce sanitary risks linked to stagnant water (vectors, water-point contamination) (Box 13.6).

Design features and construction considerations for showers are summarised in Table 13.XII and Figure 13.24. It is possible to use concrete, gravel or other materials for shower floors to avoid the production of stagnant water. In cold situations, hot water must be provided. ACF built showers with hot water in Chechen displaced people's camps in Ingushetia (Figure 13.24C) as well as in Iran after the earthquake of 2003.

#### Box 13.6

Requirements for the correct operation of showers and laundries.

Water must be readily available.

The floor must be essentially smooth with a small slope towards a drain leading to the exterior of the facility.

Measures that avoid stagnant water should be put in place, as follows:

- it is preferable to install the drain following the slope, and to let the water to infiltrate where the soil has sufficiently permeability;
- a grease-trap and soakaway pit are provided where infiltration rates are lower and where there is no natural slope for drainage (see Box 13.4);
- small plots or gardens can be planted where wastewater is drained to.

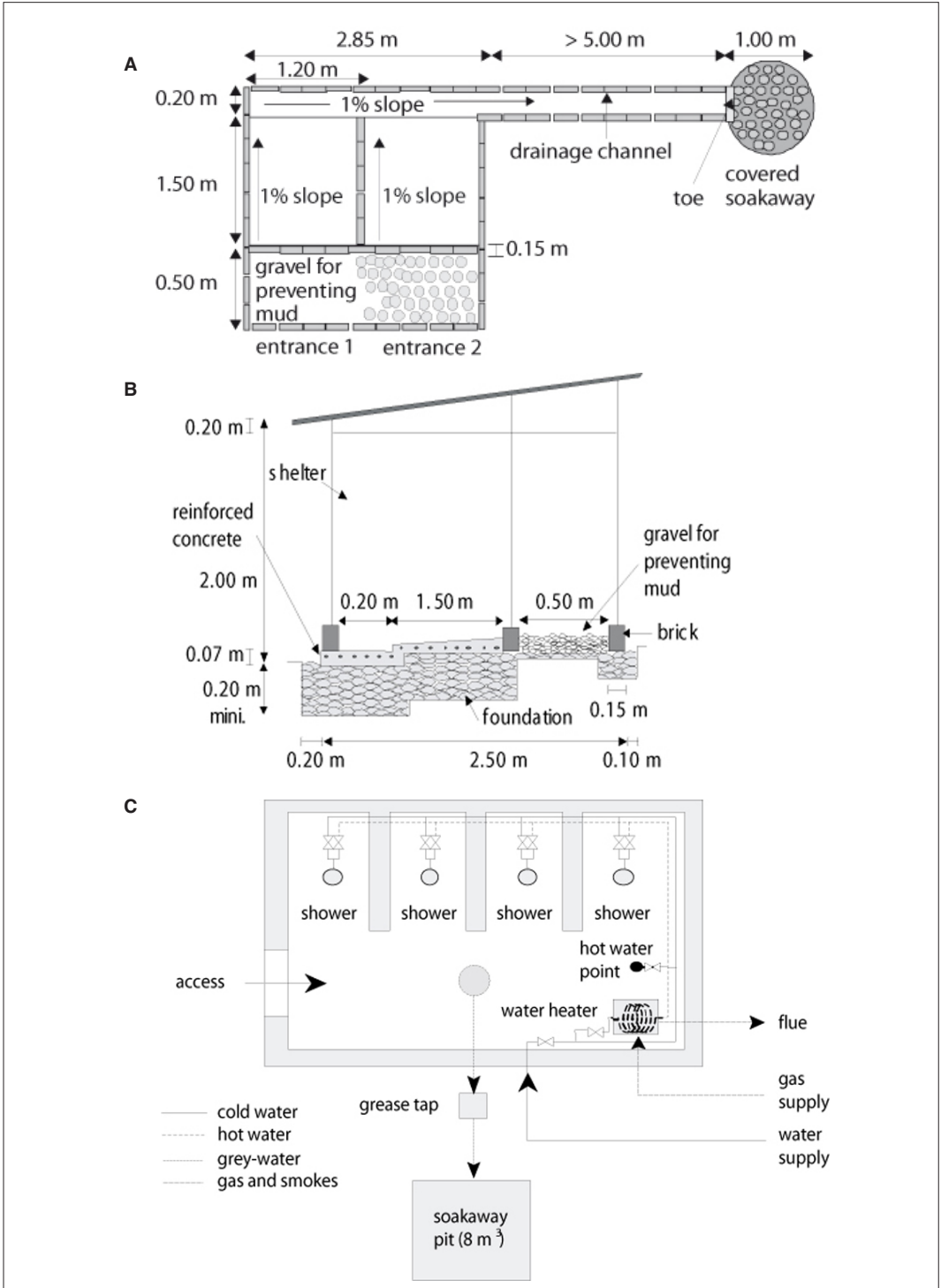


Figure 13.24: Showers.

A: plan (2 units) with soakaway. B: section (2 units). C: plan of a block (4 units) of hot water showers (ACF, Ingushetia, 2001).

**Tab 13.XII : Characteristics and construction of shower blocks (2 cubicles).**

Distances to maintain	
shower – water point	50 m
shower – dwelling	10-250 m
Shower cubicles per block	≤ 10
Materials (5 m drain and 3 m infiltration trench)	2.5 m <sup>3</sup> stone, 5.5 bags cement, 0.55 m <sup>3</sup> bricks, 0.4 m <sup>3</sup> sand, 0.55 m <sup>3</sup> gravel 115 m of 6-mm reinforcing steel, 3 kg binding wire 9 pieces 2.5-m timber (width 0.15 m) 20 pieces 2.9-m timber (width 0.07 m) 35 m <sup>2</sup> plastic sheeting 2 kg of 7 and 10-cm nails
Personnel	1 bricklayer and 4 assistants for 3 days
Tools	4 shovels, 4 picks, 2 buckets (12-l), 1 wheelbarrow, 1 spirit level, 1 pair of shears, 1 measuring tape, 2 carpenter's hammers, 1 saw, 2 trowels, 10 m of 4-mm cord
Construction	Digging foundations Filling with hardcore Preparation of reinforcement Pouring concrete, leaving enough run-off slope to avoid stagnant water Building low brick walls to take the poles for the structure Building roof and fixing plastic sheeting or matting Laying gravel to prevent mud in the corridor Constructing the drainage channel and infiltration trench or soakaway pit

### 5.1.2.2 Laundry areas

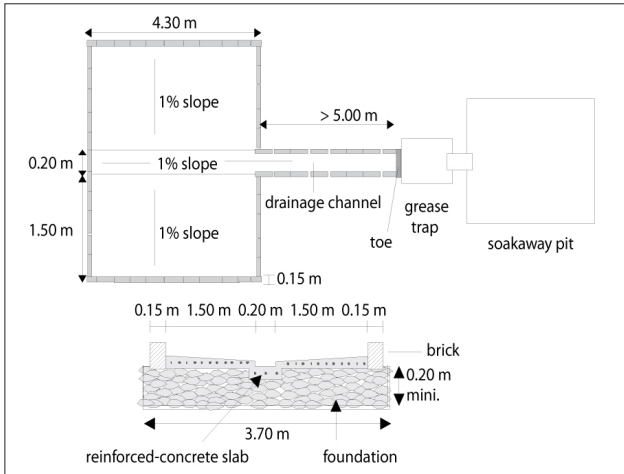
The washing of clothes, fundamental for personal hygiene, is often not carried out adequately because of the lack of facilities such as a laundry area, and is encouraged by the improvement of facilities coupled with hygiene promotion. Laundry areas also limit the risk of stagnant water from washing clothes (Box 13.6). The availability of space and of simple facilities to dry clothes must be considered when planning a laundry facility. Laundry areas are normally located near safe water points, preferably in the vicinity of springs or along streams, down-stream from the community or camp. These facilities also play an important social role, as they serve as social gathering point (specially for women), and this must be considered when deciding between a household- or community-based strategy.

Design characteristics and construction considerations for laundries are shown in Table 13.XIII & Figure 13.25.

**Table 13.XIII: Characteristics and construction of laundry areas.**

Materials (5 m channel, 3 m infiltration trench*)	4.3 m <sup>3</sup> stone, 10 bags cement ; 0.6 m <sup>3</sup> brick, 0.7 m <sup>3</sup> sand; 1 m <sup>3</sup> gravel, 230 m of 6-mm reinforcing steel, 1.5 kg binding wire
Personnel	1 bricklayer and 4 assistants for 3 days
Tools	4 shovels, 4 picks, 2 buckets (12-l), 1 wheelbarrow, 1 spirit level, 1 pair of shears, 1 measuring tape, 2 trowels, 10 m of 4-mm cord
Construction	As for shower block

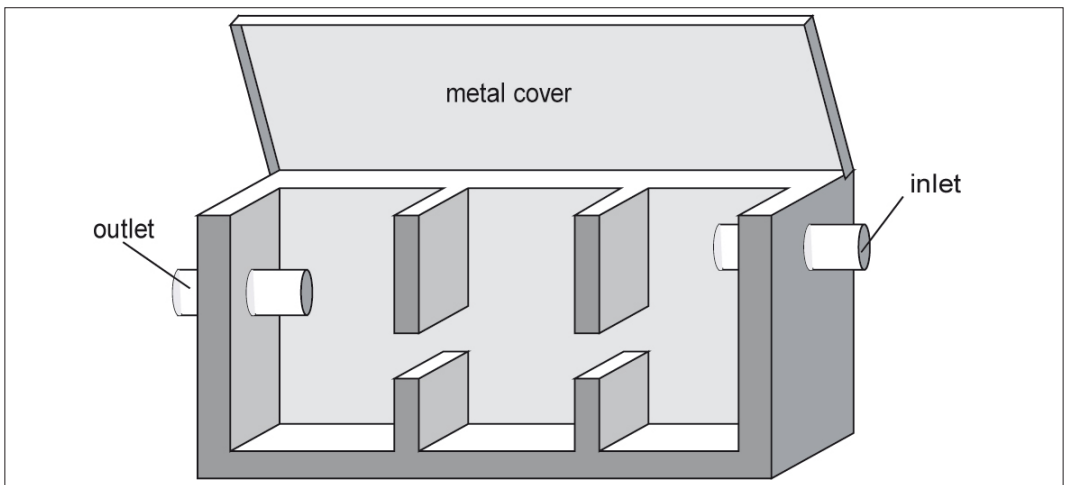
\* Also a soakaway is possible.



**Figure 13.25: Washing area with soakaway pit.**

## 5.2 Grease traps

Grease traps (Figure 13.26) facilitate the removal of grease and oil from wastewater. They are installed in the drainage systems of kitchens, showers, laundry areas and other washing facilities, and normally consist of a box (that can be one half of a metal 200-l drum) with baffles made from wood or other suitable materials. Water circulates freely through the baffles with the water level above the gap in the baffle, thus, trapping any floating oils and scum in the box. The grease trap should be emptied daily and the residues buried.



**Figure 13.26: Grease trap, ACF Ingushetia 2003.**

## 5.3 Surface-water drainage

Water is an ideal host environment for many bacteria and insects, and stagnant waters are a factor in the transmission of diseases that are water-borne or water-based, or carried by water-related insect vectors. Stagnant water may result from the blockage of water flow, by the accumulation of rain water, or as a result of wastewater from water-supply and sanitation systems. Drainage systems are also necessary to control run-off after heavy rainfall, that can potentially damage infrastructure.

The principle of drainage systems is to channel wastewater along natural slopes to transport it away from human habitation into a natural drainage system or artificial infiltration system.

Surface-water drainage systems should be planned after topographical studies to determine the slope of the terrain (see Chapter 11A). The dimensions of the drainage system will be a function of the volume of water that it will carry, the design and construction constraints associated with urban, village or rural contexts, and the resources available. Bridges, or platforms, that allow people and vehicles to move over drainage channels need to be designed into any system.

The main activities during drainage construction include: the sizing and measurement of a drainage network (which must include an analysis of the intensity and the periodicity of rainfall), the actual construction and maintenance of the system (which must include community participation), the protection of the channel margins against erosion (e.g. by soil stabilisation through tree-planting).

Drainage channels can be dug manually or by machine. For manual digging, it is important to involve the community. Channels may or may not be covered or protected. Protection can be made with concrete or stone, and must be removable to facilitate maintenance operations.

Maintenance of the system must be done on a regular basis as an accumulation of materials such as dead vegetation, refuse and silt may obstruct the water flow, leading to overflows and an unsafe environment.

## 5.4 Vector control

### 5.4.1 METHODOLOGY

Vector-control measures aim to reduce the risks of the development and transmission of diseases such as malaria, transmitted by *Anopheles* mosquitoes, rabies, which can be transmitted by rats, or a number of faecal-oral diseases transmitted by flies.

However, the presence of vector organisms does not necessarily imply a health risk. It is necessary to collate information about the health of the community (such as the incidence and types of diseases present), the hygiene habits of the community and the environmental sanitation risks, before implementing a vector-control programme.

Box 13.7 summarises the methodology of a vector-control intervention.

#### Box 13.7

##### Intervention Methodology for Vector Control.

Identification of the vector-related diseases and areas of risk.

Prevention measures for settlement in areas of risk.

Removal or modification of the vector-breeding sites:

- construction of a drainage system and elimination of stagnant waters or wet areas;
- refuse collection;
- sanitation measures in general.

Control of the vectors:

- cleaning of latrine slabs and superstructures;
- use of insecticides and rodenticides;
- tsetse-fly traps;
- hygiene-promotion programme.

Prevention measures:

- mosquito-net distribution: general distribution with special attention to maternity or health centres, and families with children under five;
- modification of dressing habits (e.g. using long sleeves to avoid insect bites);
- hygiene promotion for prevention.

Table 13.XIV lists the major vectors and the diseases that they transmit, the environments that favour their development, and the important measures that can be taken for their control.

**Table 13.XIV: Vectors that can pose health risks.**

Vector	Health risk	Favoured environment	Control measures
Flies	Eye infections (particularly among children), diarrhoeal diseases	Exposed food, excreta, dead animals	Improve environmental sanitation (collection and disposal of organic refuse, dead animals etc.) and use of VIP-type or pour-flush latrines Promote the use of screens on windows (houses, hospitals etc.) Spray refuse with insecticides
Mosquitoes	Malaria, filariasis, encephalitis	Stagnant water, mainly in the perimeter of flooded areas, and slowly flowing water bodies	Removal of stagnant water sites (puddles, cans, tyres etc.) or spraying with larvicide
	Yellow fever and dengue	Stored water in or near homes Pond or rain water accumulated in containers, cans or old tyres	Insecticide control by spraying mosquito-infested sites Promote the use of mosquito nets
Mites	Scabies, scrub typhus	Crowded areas and poor personal hygiene	
Lice	Epidemic typhus, relapsing fever		Improve personal hygiene In severe cases, spray people and clothes with insecticides suitable for use on humans
Fleas	Plague, murine typhus	Infected animals, particularly rats (see 'Rats' below)	Fumigate rodent burrows with insecticides Treatment of beds In severe cases, spray people and clothes with insecticides suitable for use on humans
Ticks	Relapsing fever, chickenpox	Infected animals (see 'Rats' below)	Chemical control in on the perimeter of the community Clear the vegetation to 50-100 m around the home or community In severe cases, use chemical control in houses (with caution)
Rats	Rat-bite fever, leptospirosis, salmonella	Food not correctly protected, refuse	Improve environmental sanitation Use rodenticides Use traps at refuse or food-storage sites

#### 5.4.2 USE OF INSECTICIDES

The use of insecticides is recommended only in extreme cases because of the health risk to workers and the general population and the fact that insects develop resistance, making it necessary to use another product.

Insecticides are designed to be effective against larvae or adult insects, and are classified into three categories: digestive, contact, and fumigants. The use of deltamethrine as a contact insecticide has been tested and used by ACF teams to combat the spread of fleas and flies. The methodology used in Benaco, Tanzania, is cited in the following programme example.



#### 5.4.2.1 Implementation on site

The aim of a contact insecticide is to put the insect in direct contact with the chemical. Therefore, the spray is directed either at the insects themselves, or at the surfaces with which they will be in contact, i.e. soil, bedding (for fleas), latrine walls (for flies).

#### 5.4.2.2 Products and preparation of solutions

The product used in Benaco was deltamethrine, a synthetic pyrethroid which is commercially available under different brand names (k-Othrine®, Decamethrine®, NRDC 161®, Cislin®, Cedis® etc.). These products are commonly supplied as a powder (2.5% active ingredient) or a liquid (25 g active ingredient per l). The dosages given in Table 13.XV refer to use of the liquid form.

**Table 13.XV: Use of insecticides.**

Type of vector	Dilution	Use
Fleas	1 l for 500 l of water	Spray for floors and bedding
Flies	1 l for 100 l of water	Spray for latrines on walls

The proportion of atomised solution to be used is 1 l per 10 m<sup>2</sup> of treated surface. The atomiser is regulated at a flow of 1 l/min. For treatment against flies, 3 to 4 sugar lumps are used per litre of solution, which serves as bait and facilitates the fixing of the solution when sprayed on vertical walls.

A team is made up of several people equipped with manual sprayers (capacity 15-20 l). Two additional people are in charge of informing the local population about spraying.

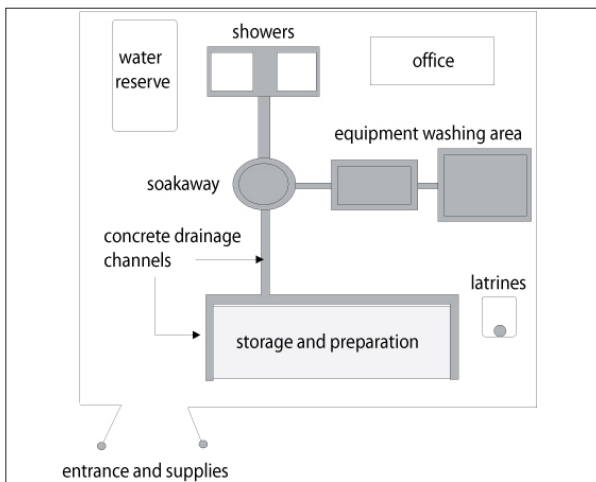
One person is in charge of stock management and the preparation of solutions, and a driver is responsible for the transport of the equipment and solution to the spraying site.

The intervention plan is as follows:

- day 1: inform the population and prepare for them to leave their houses during spraying on day 2;
- day 2: supply sites with the vehicle, then spray.

#### 5.4.2.3 Organisation of storage premises and preparation of insecticides

Several precautions must be taken at the time of the preparation and use of insecticides, particularly those for external use. These precautions are listed in Table 13.XVI and the preparation area is illustrated in Figure 13.27.



**Figure 13.27: Insecticide preparation area.**

**Table 13.XVI: Precautions to be taken during the preparation and use of insecticides.**

Protection of personnel	Mask, gloves, goggles, overalls, boots
Washing of preparation & spraying material	Once a day, systematically
Washing of clothes	Once a week, systematically
Facilities required	Showers, washing tubs, concrete drainage channels, soakaway

## 5.5 Management of solid waste

### 5.5.1 INTRODUCTION

The quantity and type of solid waste generated by a community depends on their living habits, which are related to their economic status. In general, wealthier communities produce more solid waste.

Domestic waste favours the development of disease vectors such as flies and rodents, and looks and smells unpleasant. It can also cause environmental hazards by blocking natural or constructed drainage systems, and increasing the risk of floods.

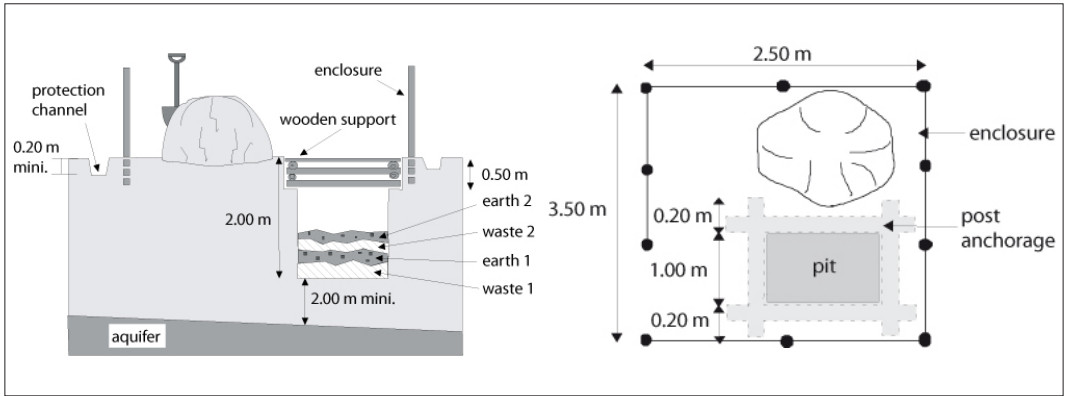
### 5.5.2 BURIAL

Domestic or collective refuse pits, where waste is buried, are one of the best solutions to combat the spread of vectors (Table 13.XVI & Figure 13.28). They are covered daily with earth, which limits the generation of smells and proliferation of insects, and accelerates decomposition. The refuse pit must be protected from children and animals by a fence, and from surface run-off by a surrounding drainage channel. It is better to bury biodegradable waste than to incinerate it.

In rural areas refuse can be reused and controlled more easily. It is possible to develop family strategies where each home has its own refuse pit. Refuse is deposited daily in pits dug by the families themselves, and covered by a layer of soil. The pit is backfilled with soil when full, and a new pit is dug. It is possible to produce compost for reuse if only organic matter is put in the pit.

**Tab 13.XVI : Characteristics and construction of refuse pits.**

Volume of waste	0.5 l /person/day
Distances to be maintained:	
pit – water point	30 m downstream of water point
pit – dwellings	20 m
bottom of the pit– aquifer	2 m
Materials (2 m <sup>3</sup> hole waterproof to a depth of 0.50 m)	10 x 1.40 m timber for the support (0.10 m dia.) 10 x 1.40 m timber for the fence (0.10 m dia.) Plastic sheeting (W= 1 m, L = 11 m) 40 nails (7-cm)
Personnel	2 people for 1.5 days
Tools	2 shovels, 2 picks, 1 bucket, 1 carpenter's hammer, 5 m of 8-mm cord
Construction	Hole digging (2 m deep) Installation of wooden struts in staggered rows Gathering of earth to cover waste Installation of a protective fence and drainage channel



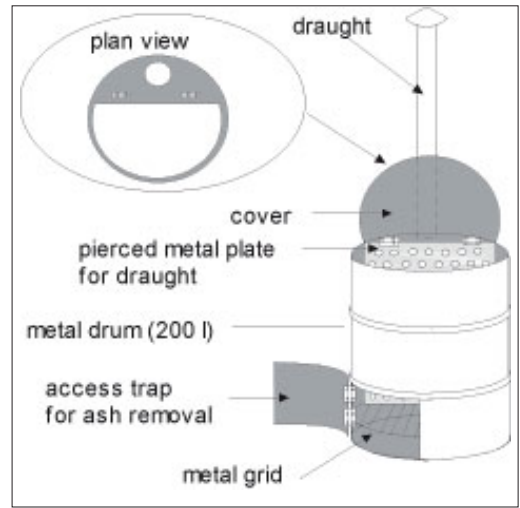
**Figure 13.28: Refuse pit.**

### 5.5.3 INCINERATION

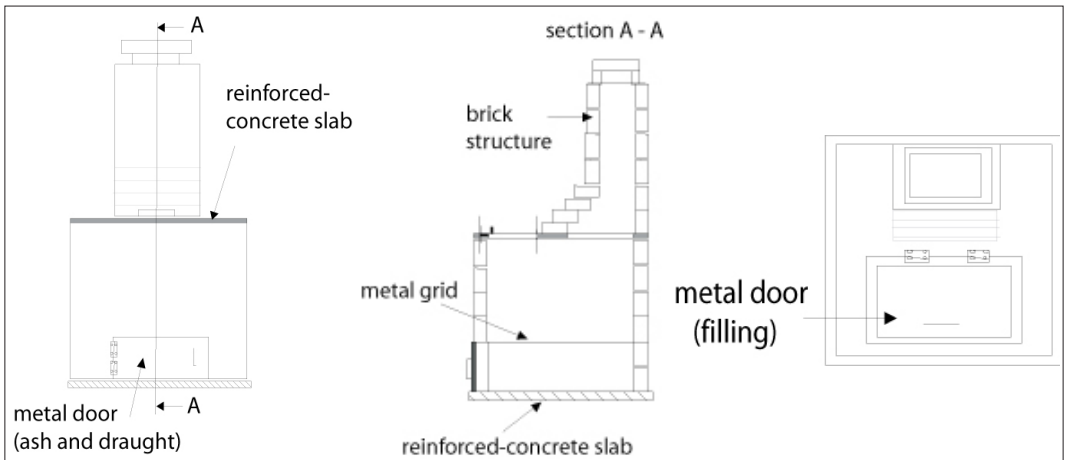
Incineration is advisable for the treatment of contaminated waste from hospitals or dispensaries, as well as for non-biodegradable waste. It can be done near living areas, including urban environments, although care must be taken in siting and designing the incinerator to avoid fire risks and contamination by toxic smoke.

An incinerator can be easily constructed using a metal barrel (noting that it becomes more susceptible to corrosion with heat, Figure 13.29). A brick-built incinerator is recommended for more permanent use (Figure 13.30).

Each type of incinerator design comprises a furnace with a hatch to remove ashes and regulate air flow, as well as a chamber for the waste with a loading trap at the top.



**Figure 13.29: Simple incinerator.**



**Figure 13.30: Brick-built incinerator.**

#### Box 13.8

##### Key aspects for refuse collection in an urban context.

The promotion of key social habits: collection and disposal of waste at specific locations, proactive participation of the community.

The refuse-collection system: emptying of dustbins and containers.

The identification of areas for final disposal: landfills.

The transport of containers to landfills using animal-drawn carts, tractors and on-road vehicles. The creation of micro-enterprises that are equipped with tools and transport for refuse collection and which receive direct payment from the community.

The separation of refuse at the final destination for treatment by burial, incineration or reuse by composting or recycling.

The coordination between different actors: community, municipal water and sanitation services, health structures and other local organisations.

#### 5.5.4 URBAN CONTEXTS

Low-income urban areas are normally characterised by poor sanitary conditions (Box 13.9). Open and unprotected refuse tips and inadequate space for digging pits are common, leading to serious public health risks. Here, community systems for refuse disposal, and sanitary landfills, offer the best solutions for waste disposal

Box 13.8 summarises key aspects for the implementation of refuse collection in an urban context.

*Note.* – The community should actively participate in the running of the system, to ensure its sustainability. The community must also appreciate that the service has a cost which it must meet, at least in part. The system requires trained staff for its operation and maintenance and also an effective management system for the removal, transport and disposal of refuse at a sanitary landfill.

#### Box 13.9

##### The effect of rapid population increases in urban areas.

Rapid urban growth in the last half of last century, due to migration from rural areas, has led to the incapacity of governments of developing countries to provide appropriate lodging and services. This has resulted in the development of peri-urban neighbourhoods characterised by poor living conditions with significant health risks.

Sanitary services present a particular problem in less well-established urban areas built without proper planning or authority, where the majority of impoverished people are located. The World Bank (2000) estimates that nearly 26% of the global urban population, over 400 million people, has limited access to simple sanitation systems as latrines. Further, many peri-urban areas lack adequate drainage and solid-waste removal systems. Environmental sanitation systems adopted by the communities are often inadequate and contribute to a highly contaminated environment that promotes the transmission of diseases. Therefore, peri-urban areas have worse health indicators than rural areas, including child mortality rates and the rates of incidence of diseases related to excreta and the environment.

Peri-urban neighbourhoods are rapidly created where families occupy empty space and build their home using any available material such as cardboard, wood, clay, iron sheets or plastic. These neighbourhoods are often constructed illegally and do not follow any urban planning or municipal codes. They comprise highly populated areas with no basic services and no infrastructure. There are normally large social and security problems in these neighbourhoods.

### 5.5.5 MANAGEMENT OF HEALTH-CENTRE WASTE

Health-centre waste poses serious health risks given the presence of contaminated material and dangerous articles including syringe needles and glass eye droppers. Apart from the physical danger of this material, needles and eye-droppers protect viruses from the action of chemical disinfectants and from the outside environment. Thus, a syringe deposited with solid waste can easily contaminate a person pricked by the needle.

Health-centre waste is normally treated by incineration, burial or other simple technologies. These strategies are most appropriate in small facilities in rural areas, but must consider that:

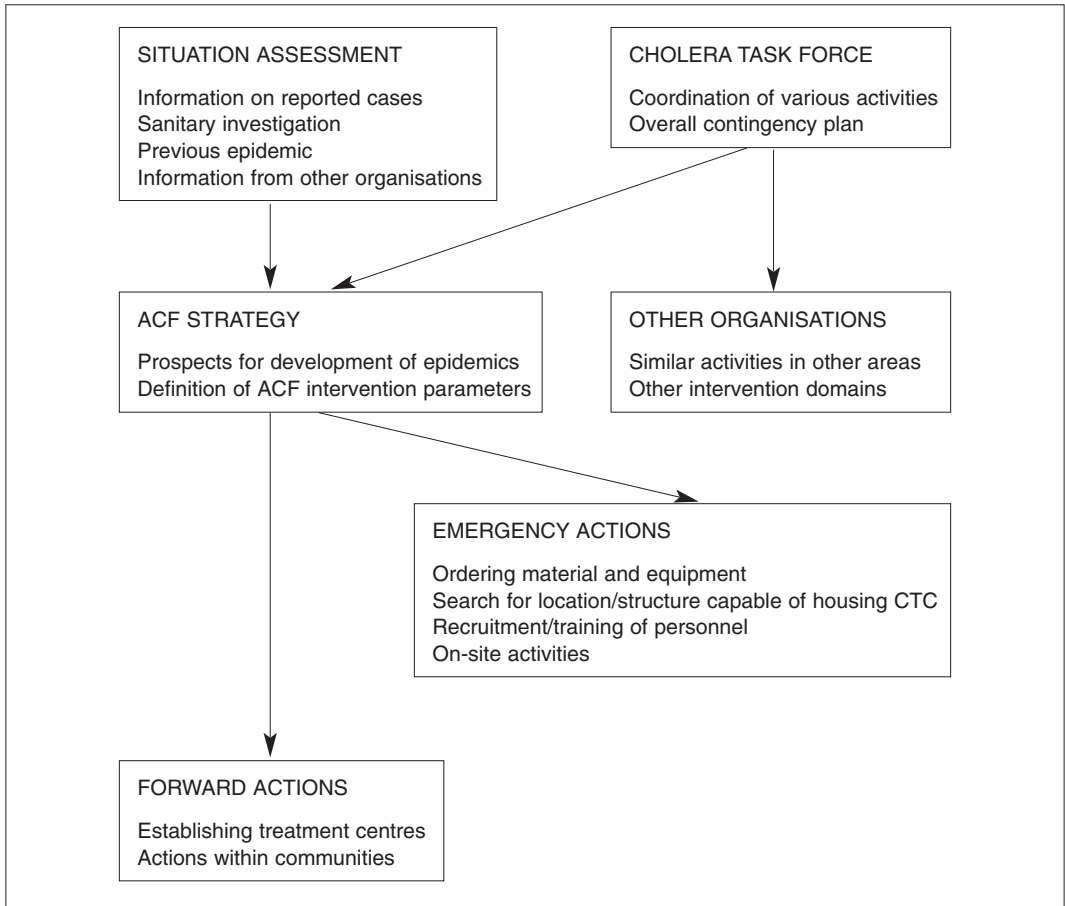
- most of the risks occur before the waste arrives at the incinerator or medical-waste pit due to inadequate management of waste disposal and storage (mainly in small or medium-sized health centres). Therefore the cooperation of hospital staff supervisors and the administration is required to ensure proper work habits of the staff;

- the provision of incinerators is not sufficient if they are not used properly by hospital staff, therefore, they must be supported by a training programme.



## Cholera

<b>1</b>	<b>General</b>	507	<b>5.8.1</b>	<i>Organigram</i>	525
1.1	Cholera vibrios	507	5.8.1.1	Expatriate personnel or Senior staff	525
1.2	Clinical signs and symptoms	507	5.8.1.2	Local personnel	526
1.3	Contamination	507	<b>5.8.2</b>	<i>Description of sanitary posts</i>	526
1.4	Prevention of infection	508	5.8.2.1	Sanitary supervisor	526
1.5	Treatment	508	5.8.2.2	Preparer of solutions	526
1.6	Vaccination	509	5.8.2.3	Sanitary facilities technician	526
1.7	Natural immunity	509	5.8.2.4	Tent sanitary technician	527
1.8	Risks to personnel	509	5.8.2.5	Tent cleaner	527
1.9	Epidemics	509	5.8.2.6	Sprayer	527
1.10	Epidemiological factors	510	5.8.2.7	Entrance sprayer	527
<b>2</b>	<b>Assessment of the situation</b>	510	5.8.2.8	Sanitary technician/sprayer of the Neutral area	527
2.1	Confirmation of reported cases, implementation of a surveillance system	510	5.8.2.9	Footbath sanitary technician	528
2.2	Previous epidemics	511	5.8.2.10	Maintenance worker	528
2.3	Sanitary surveys	511	5.8.2.11	Mortuary worker	529
2.4	Cholera task force	511	5.8.2.12	Laundry workers	529
<b>3</b>	<b>Intervention strategy</b>	512	<b>5.8.3</b>	<i>Recruitment and training</i>	529
3.1	Development of the epidemic	512	5.8.3.1	Staff profiles	529
3.1.1	<i>Determining the number of sick people</i>	512	5.8.3.2	Training	529
3.1.2	<i>Evaluation of the duration of an epidemic</i>	512	<b>5.8.4</b>	<i>Information</i>	530
3.2	Sanitary strategy/actions	512	5.9	Other structures and contexts	530
<b>4</b>	<b>Types of intervention</b>	512	<b>5.9.1</b>	<i>Building</i>	530
4.1	Large cholera treatment centre	512	<b>5.9.2</b>	<i>Low-capacity centre</i>	530
4.2	Small-scale cholera treatment centre	513	<b>6</b>	<b>Actions in the community</b>	531
4.3	Attachment to local structures	514	6.1	Information and hygiene advice	531
4.4	Health Ministry support	514	6.2	Improving water quality	531
4.5	Emergency actions	514	6.2.1	<i>Chlorination of water points</i>	532
<b>5</b>	<b>Cholera treatment centre (CTC)</b>	515	6.2.1.1	Municipal water-distribution system	532
5.1	Planning	515	6.2.1.2	Shallow boreholes and wells	532
5.2	Choice of site	516	6.2.2	<i>Distribution of disinfectant to households</i>	532
5.3	Layout of a CTC	517	6.3	Examples of specific actions	534
5.4	Water supply	520	6.3.1	<i>Closed risk areas: camps</i>	534
5.4.1	<i>Storage</i>	521	6.3.2	<i>Open risk areas: large towns and extended rural areas</i>	534
5.4.2	<i>Distribution</i>	521	<b>7</b>	<b>End of the intervention</b>	535
5.5	Sanitary facilities	521	7.1	Disengagement	535
5.5.1	<i>Footbaths and hand-washing facilities</i>	521	7.1.1	<i>Treatment centre managed or supported by an NGO</i>	535
5.5.2	<i>Excreta-disposal pit</i>	522	7.1.2	<i>Verification and improvement of water quality</i>	535
5.5.3	<i>Latrines</i>	522	7.1.3	<i>Selective training/disinfection teams</i>	535
5.5.4	<i>Shower</i>	522	7.2	Evaluation	536
5.5.5	<i>Incinerator</i>	522	7.2.1	<i>Initial assumptions</i>	536
5.5.6	<i>ORS points and hand-washing facilities</i>	523	7.2.2	<i>Epidemiological data</i>	536
5.5.7	<i>Washing area</i>	523	7.2.3	<i>Costs</i>	537
5.5.8	<i>Solution preparation facility</i>	523	7.3	After the cholera response	537
5.5.9	<i>Minor equipment</i>	524			
5.5.10	<i>Drainage</i>	524			
5.6	Shelters	524			
5.7	Sanitary barriers	524			
5.8	Management	525			



**Figure 14.1:** Stages in planning and implementing a sanitary programme to control cholera (CTC – Cholera Treatment Centre – see Section 5).

Cholera is just one of many diarrhoeal diseases although it is the best known and the most widely publicised. Other diarrhoeal diseases can create many more victims, with epidemics (for example, in Guatemala 1968, with 120 000 cases of shigellosis and 12 000 deaths in one year), or in situations of chronic poverty (for example, in South America they are responsible for a third of child mortality).

Lack of adequate drinking-water supplies and sanitation, as well as lack of education, all synonymous with poverty, make the fight against diarrhoeal diseases a priority in many countries, regardless of epidemics. In this context, ACF's water and sanitation programmes contribute to a general improvement in health by acting in the complementary fields of improvement of infrastructure and education, for which close collaboration with the medical profession is necessary. Lastly, each intervention in an epidemic depends on the context, so the general principles presented here must be adapted to each specific context.

The medical treatment of cholera, and the sanitary measures aimed at preventing transmission, are not highly technical. The essentials are to respond quickly, to be organised and to have effective logistics. It is therefore necessary to be prepared (Figure 14.1).

In this chapter, the basic facts about cholera are presented, followed by the various stages in the creation and implementation of a sanitary programme.



# 1 Cholera: general

## 1.1 Cholera vibrios

Cholera vibrios are bacteria that can cause cholera when ingested. Whether or not the disease develops depends on the quantity of vibrios ingested (the infective dose is in the order of 100 000), and on the organism's ability to defend itself against this infection. To a certain extent, the acidity of the stomach is fatal to vibrios (termed the gastric barrier). It is also possible to be a healthy carrier (see Section 1.3).

The vibrios produce a toxin that stimulates the cells of the gut wall to pump water and mineral salts from the blood and tissues into the intestine.

Outside the human body, cholera vibrios can survive for several days to several months in a favourable environment, such as humid alkaline and saline environments (sweat, brackish wells, sewers). On the other hand, they cannot survive dryness, acidity and exposure to sunshine, and are limited by competition with other microorganisms.

## 1.2 Clinical signs and symptoms

After a brief incubation period of 2 to 3 days, patients present several symptoms:

- frequent and abundant diarrhoea (several litres in a few hours) with watery, colourless stools, 'rice water' (with lumps), and a slight smell of fish. There is usually no fever;
- vomiting (often), sometimes with painful cramps.

Within a few hours, dehydration and exhaustion can become fatal. Children younger than two are rarely affected, while the death of healthy adults, within 24 to 48 h, is an indication of cholera.

According to WHO (1993), cholera should be suspected when:

- a patient older than 5 years develops severe dehydration from acute watery diarrhoea (usually with vomiting);
- any patient above the age of 2 years has acute watery diarrhoea in an area where there is an outbreak of cholera.

Bacteriological verification is essential to confirm the presence of the epidemic, and it is necessary to carry out an antibiotic survey to determine sensitivity to antibiotics.

## 1.3 Contamination

Human beings are the main reservoir of vibrios, which are found in considerable quantities in the stools (1 000 000 per g), vomit and sweat of cholera patients, and in dead bodies.

Healthy carriers are also sources of contamination, and are a danger because of their mobility, and their ignorance about their state: in an endemic coastal area of West Africa, there were up to 25 healthy carriers for every sick person. Nevertheless, the proportion of sick people/healthy carriers is usually nearer 1 to 10.

The excretion duration of the vibrio does not exceed 1 week in 70% of cases (90% of the carriers do not excrete vibrios after 2 weeks).

The two main ways that cholera vibrios are carried from stools and vomit are manual contact (cholera is a 'disease of dirty hands') and water (polluted sources and water points). Bad hygiene contaminates the hands, which in turn contaminate food, dishes, clothes, water, and other hands. Whereas manual contact is always a contamination mode, water can, under certain conditions, have little or no effect.

Water, particularly if it is saline and muddy (for example, in ports), is a good reservoir in which vibrio can survive for months; this is the case in Mogadishu, Somalia. If the reservoir is periodically re-supplied by contaminating carriers, it can become permanent. Seaweed, fish, and shellfish also become contaminants by concentrating the vibrios present in the environment.

On the other hand, flies, although commonly mentioned as transmission vectors, are unlikely to carry a sufficient number of vibrios to be a significant vector of cholera.

## 1.4 Prevention of infection

Action must cover:

- the sick patient (easily identifiable), who must be isolated and treated in specialised centre with strict disinfection measures;
- healthy carriers: non identifiable, persons at risk, including families of sick persons;
- transmission areas: water points, defecation fields, meeting places (markets, schools, churches etc.).

## 1.5 Treatment

The disease can be fatal, but if patients are hospitalised and treated quickly, recovery is rapid and spectacular. Sick people can sometimes recover without assistance, but in the meantime they will have infected others, who will not always have the same chance of surviving. This is the reason why the treatment includes isolating patients from the community in a specialised cholera treatment centre (Figure 14.2).

Initially, rapid rehydration, depending on the seriousness of the symptoms and the grade of dehydration, is carried out:

- orally, with water and a solution of oral rehydration salts (ORS) if dehydration is moderate (grade A and B of dehydration). ORS have practically the same composition as the losses from the patient, but contain more glucose to facilitate their absorption;
- intravenously (IV), with Ringers lactate (plastic pack containing 1 litre of ready-to-use solution) if dehydration is severe (grade C). This more technical method allows severely ill patients to be saved, but demands precise control and a great quantity of solution (similar to the losses in diarrhoea and vomit, up to 8 l/patient/day for severe cases). The patient should go on to ORS rehydration as soon as possible (when vomiting has reduced).

In order to avoid the development of resistance, and to avoid increasing the complexity of treatment, antibiotics are not administered systematically. However, antibiotic treatment has the advantage of reducing the seriousness and duration of the diarrhoea (and therefore the use of Ringer’s lactate, and the time at the treatment centre), and especially of reducing the carrier duration (and therefore the possibility of contamination) to a few days. Prophylactic chemotherapy is very controversial.

	<div style="border: 1px solid black; padding: 5px; display: inline-block;">INGESTION OF VIBRIOS</div>			
Symptoms	Severe		Moderate Diarrhoea	None
	Severe dehydration	Moderate dehydration		
Treatment	IV + ORS Antibiotic	ORS Antibiotic		
Development	Death/recovery	Recovery	Recovery	
Contamination	Very serious		Serious	Moderate
Situation	Patients in CTC		Healthy carriers	

**Figure 14.2: Cholera: symptoms, treatments, contamination.**

## 1.6 Vaccination

Vaccination is also controversial: its effect is limited (50%), and delayed (starting one week after the vaccination). The implementation of a vaccination campaign is difficult: it involves significant resources, and can produce a sense of false security with consequent relaxation of hygiene measures.

A new vaccine (oral administration in two doses) exists, but it has not yet been validated on a large scale.

## 1.7 Natural immunity

This kind of natural immunity, created as a result of cholera infection, is proportional to the seriousness of the symptoms. The immunity from an infection, symptomatic or not, is rapidly acquired in less than one week, and has a duration of less than three months. It partially explains the fact that, in an endemic area, epidemics may be limited in scale but can recur after a few months.

## 1.8 Risks to personnel

Personnel working in cholera treatment centres and in contact with patients are no more likely to be affected than the general population if sanitary measures are respected. Furthermore, detection is almost immediate, and so the treatment is quick, and therefore effective.

## 1.9 Epidemics

Epidemics are classified according to the environment (Figure 14.3).

*In a humid area* during the rainy season (endemic areas), epidemic outbreaks can affect 1 to 3% of the population, starting from an endemic state linked to a reservoir with a low density of vibrios (the water). Because of the endemic situation, the population is generally aware of the symptoms of the disease and has a certain degree of natural immunity, and medical staff have experience in managing cholera. These factors tend to produce epidemics with a low proportion of sick people, and the following characteristics::

- epidemic peaks after 3 to 4 weeks;
- duration of 2 months;
- example: West African coastal regions.

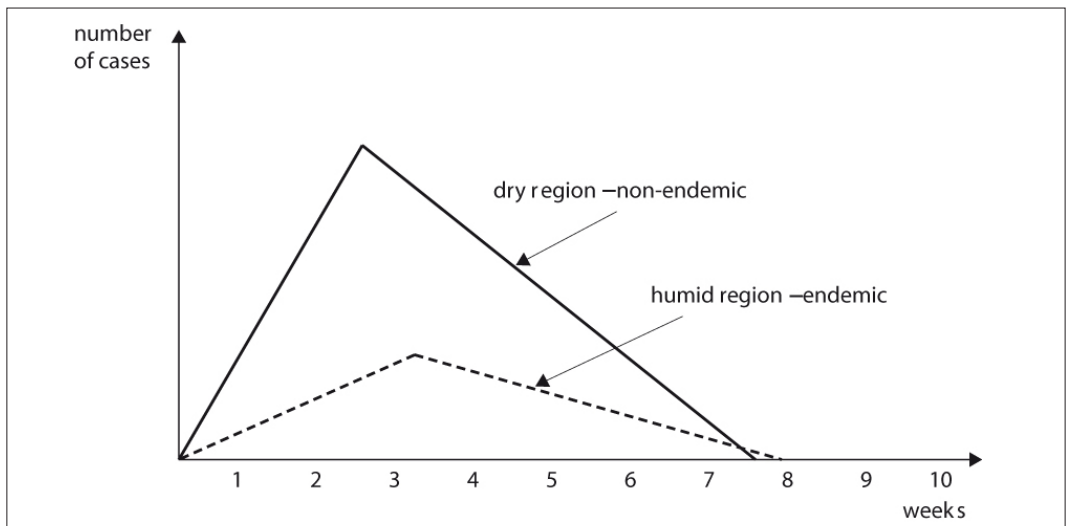


Figure 14.3: Typical epidemic curves.

*In a dry area* during the dry season, epidemic outbreaks are brief and intense, but can exceptionally affect up to 30% of the population, around foci of infection. Contamination is direct, from individual to individual. It does not become endemic because the environment is not favourable. There is no auto-immunisation through recent previous exposure, and there is a general ignorance of the symptoms. The number of healthy carriers is low (5 carriers per sick person). Good transport links favour the periodic infection of these regions from endemic areas:

- epidemic peaks after 10 to 12 days;
- example: Sahelian countries (Chad, Mali).

In fact, these extremes rarely occur. The characteristics of an epidemic depend on a multitude of factors, mainly human intervention, which can decrease its effect, especially if carried out quickly. In a closed environment (camp), it is relatively easy to monitor water quality and implement disinfection measures that can at least limit the daily appearance of new cases, and decrease the total number of patients. Action is more difficult in an open environment, and requires careful analysis of the origin of cases, as well as a good knowledge of local habits, to identify the specific measures capable of limiting the epidemic.

The notions of peak and duration of the epidemic are somewhat imprecise:

- they apply to a restricted population (a village or small region), but not to a country where the regions are generally affected one after another;
- they assume that the date of appearance of the epidemic is known, which is rarely the case.

## 1.10 Epidemiological factors

These factors are directly derived from the main contamination mode. The main aggravating factors are poor sanitary conditions (water and sanitation), and a high human concentration (camps, markets, stations, schools etc.).

Climatic factors are secondary and may have differing effects:

- in a dry area, the appearance of the rainy season decreases the concentration of the population around scarce water points, and the transmission of infection seems to reduce because the number of cases decreases, though the link between these factors is not certain;
- on the other hand, in an endemic humid area, epidemics appear during the rainy season (contamination from the main centres of infection).

## 2 Assessment of the situation

From the first suspected cases declared in countries where ACF is working, it is impossible not to be involved, even if the local authorities seem capable of managing a possible epidemic, and so certain key pieces of information must be investigated and analysed (Table 14.I).

### 2.1 Confirmation of reported cases, implementation of a surveillance system

The clinical diagnosis of the first cases must be confirmed by stool sample analyses in order to identify the vibrio and determine its sensitivity to various antibiotics.

These biological analyses must be complemented by epidemiological data gathered from health structures and communities. It is therefore essential to create a reliable epidemiological surveillance system as quickly as possible in order to monitor the development of the number of cases over time and area. If at all possible, this surveillance system must be based on the existing national health structures.

Mobile teams (disinfection, education) can complete this surveillance system.

**Table 14.I: Assessment of the situation.**

Source	Information to be investigated
Reported cases	Location Number Confirmation by laboratory analysis
Sanitary surveys	Number of people and concentration in the risk area Antecedents of previous epidemics: people displaced from an endemic area, local population of a non-endemic area etc. Water resources: springs, streams, wells etc. Vulnerability of water points to faecal contamination Sanitary equipment: latrines, showers etc. Hygiene behaviour List of health structures, knowledge of the disease and sanitary infrastructure
Previous epidemic	Origin, development, means of contamination
Other agencies Cholera task force	Information on cholera

## 2.2 Previous epidemics

Information on previous epidemics can help confirm the indications of the sanitary survey, especially regarding the origin of the epidemic (wells, ports, markets etc.), and means of propagation of the disease.

## 2.3 Sanitary surveys

These surveys identify the main infection centres, and provide baseline data for sanitary actions. This work, which must be carried out as quickly as possible, is monitored and refined as effective intervention is carried out on the ground.

## 2.4 Cholera task force

Co-ordination with other organisations involved locally (by geographical or technical sector) facilitates task allocation and speedier intervention. A working group, sometimes called a ‘Cholera Task Force’, brings together the parties normally involved, including: Ministry of Health, WHO, UNICEF, UNHCR, Red Cross / Red Crescent and NGOs. To be efficient, this working group must not be too large.

Technical subcommittees (medical, water and sanitation, and hygiene communication) of 6 to 8 people meet regularly, and sanitary actions are coordinated within the water and sanitation committee. At the beginning, it is necessary to assess members’ capacity of action in these meetings, taking into account:

- experience on the ground;
- current programmes: location, nature (water and sanitation, medical, education etc.);
- speed of access to financial, human, and logistics resources such as stocks of rehydration salts, medical supplies, and water supply and sanitation equipment.

A plan of action (contingency plan) is developed. The task force guides the intervention by collecting and analysing data on the epidemic, planning activities (opening of treatment centres, water supply, sanitation and hygiene promotion activities), harmonising the interventions of the various organisations and evaluating the impact of the activities carried out.

## 3 Intervention strategy

### 3.1 Development of the epidemic

Once the epidemiological data has been collected and the sanitary survey completed, assumptions about the areas at risk (transport routes, markets etc.) and the most important contamination modes (water, market, cheap restaurant food, fish, dairy products etc.) can be formed.

#### 3.1.1 DETERMINING THE NUMBER OF SICK PEOPLE

The estimation of the number of sick people to be hospitalised is made on the basis of the attack rate, i.e. the likely number of sick people per total population. In the absence of information about previous epidemics in the area, it is assumed to be 1% for open environments, and 2% for environments at risk (camps and other closed environments). In dry, non-endemic regions, the attack rate may be far higher (see Section 1.9).

#### 3.1.2 EVALUATION OF THE DURATION OF AN EPIDEMIC

The duration of a 'classic' epidemic is 3 months, at least in its acute phase. After that, it is necessary to consider the withdrawal of international NGOs, and the reinforcement of local structures to continue the activities.

### 3.2 Sanitary strategy/actions

The actions to be implemented have the objective of reducing contamination, and are based on two approaches: hygiene promotion and disinfection. One cannot occur without the other, since cholera is, above all, a disease of lack of hygiene, caused by risky hygiene knowledge and practices and/or lack of sanitary structures. The intervention strategy must prevent, or at least limit, the contamination routes identified in the assessment.

Secondary infection centres are:

- in the community: water points, dwellings and surroundings of sick people, defecation fields, public places (markets, restaurants etc.);
- at the treatment centre: contact with patients/personnel/visitors.

Sanitary activities (Table 14.II) are carried out in the cholera treatment centre, where everything must be done to guarantee a healthy environment with effective sanitary barriers, but also in the community, where actions targeted on areas at risk are essential: disinfection of drinking water and sick people's dwellings, and health information in the local radio, for example.

## 4 Types of intervention

### 4.1 Large cholera treatment centre

#### *Context*

When no government structure can or will treat patients on a large scale.

#### *Advantages*

- Possible dissociation of medical and sanitary interventions (possibility of allocating tasks between the various NGOs).
- Purpose-built, highly operational centre (strict sanitary barriers, adequate capacity), with specialist input from an NGO experienced in water supply and sanitation (though this needs to be coordinated with medical activities).

**Table 14.II: Sanitary activities.**

	CTC	Community
Targets	People at risk – patients – carers – personnel	Environment of patients – family – neighbours Public buildings – schools – market – mosque/church/temple
Potable water	Supply Storage, chlorination and distribution	Quality analysis and, depending on results: – point disinfection – periodic chlorination (up to twice a day) – improvement/protection – closure of water point – substitute supply
Sanitation and disinfection	Building of infrastructure: latrines, showers, footbaths Disinfection: stools, vomit, fabrics, soles of feet and shoes, water points Hand-washing	Case detection and visit to key areas: – families and neighbours of the patients – schools, markets etc. Disinfection of areas at risk: – houses and latrines of patients' contacts – schools, markets, restaurants etc.
Education/information	General information about cholera and acquaintance with hygiene measures Explanation of the actions taken in the community	

- Possible control of recruitment, training and management of personnel (on condition of being able to pay salaries or allowances – sometimes food for work).
- Rigorous epidemiological monitoring.

#### *Disadvantages*

- Large investment in financial and human resources over 3 months.
- The centre is only built when the epidemic has been confirmed: building a large CTC as a preparedness measure is only done in very particular situations.

## 4.2 Small-scale cholera treatment centre

### *Context*

When the size of the affected area does not allow sick people to reach one large CTC (large cities, most rural areas).

These small and decentralised centres are generally linked to existing health structures, and allow early detection of cholera diarrhoea and treatment within easy reach of the population.

If the local treatment capacity is exceeded, local patients can be transferred to other structures.

### *Advantages*

- Global intervention (medical and sanitary) by a single NGO.
- Reduced setting-up and operating costs.
- Retention of some treatment capacity in small structures, which takes the pressure off large treatment centres.
- Reduction in the number of serious cases at admission thanks to early detection and treatment over a large area.

### *Disadvantages*

- Difficulty of transferring seriously-affected patients: the patient's family may disagree with the decision (to a great extent, agreement depends on the staff's interpersonal skills).
- Quick overload of the CTC if transfers are not possible.

## 4.3 Attachment to local structures

### *Context*

Small cholera treatment units can be attached to local health structures (health posts or dispensaries) that are supported with supplies (ORS, medicines), training and technical support (medical, water and sanitation).

### *Advantages*

- Rapid detection and treatment due to the proximity of sick people.
- Low investment required for the improvement of existing structures.
- Regular training, monitoring and supply ensured by a mobile team covering several centres.

### *Disadvantages*

- Variable local competences and availabilities.
- Need to ensure a minimum standard, from a medical and sanitary point of view, in structures ill-fitted for this purpose.
- Difficult mobilisation of personnel without a financial incentive (salary or food-for-work).
- Capacity quickly exceeded in a densely populated area (urban environment).
- Low geographical coverage.
- Isolation of patients is more difficult.

## 4.4 Health Ministry support

### *Advantages*

- Quick and effective supplies (mainly of Ringer's lactate) ensured.
- Ready-trained personnel.
- Existing structures.

### *Disadvantages*

- Difficult control of medicine supply (possible diversions).
- Collection and management of epidemiological data may not be sufficient.
- Additional sanitation facilities are required (existing facilities are difficult to adapt, particularly in hospitals).

### *Appropriate arrangements*

- The NGO supplies the treatment centres directly, rather than supplying a central pharmacy.
- Weekly supplies against presentation of epidemiological data.
- Training on the use of chlorine in the centres.
- Implementation of sanitary protocols in the centres.
- Joint sanitary supervision by NGO and Ministry of Health.
- Depending on the strategy adopted, and the context (sanitary action alone, or medical plus sanitary action), emergency actions are implemented as soon as the first cases are declared, to allow full-scale action as soon as the epidemic is confirmed.

## 4.5 Emergency actions

It is possible to order ready-made cholera kits for the CTCs, but supplies and equipment should be bought locally if possible (see Section 5.5.8). Whatever the option chosen, 200 kg of HTH and



10 sprayers should be purchased immediately. Recruitment and training of medical, sanitary and hygiene-promotion personnel (see Section 5.8) should also begin.

Home visits (hygiene education/disinfection and collection of information) can start very quickly (see Section 6).

## 5 Cholera treatment centre (CTC)

Concentrating patients in one centre ensures both patient care and avoidance of contamination. This is enabled not only through the administration of medicines (ORS, Ringer's lactate), or the essential use of disinfectant (chlorine etc.). The routine of a centre is organised around a set of actions (disinfection of hands, feet, stools etc.), that are simple, but often new for patients and carers who just stay for a short time. In order for these actions to be assimilated and put into practice as quickly as possible by new arrivals, it is necessary to do the following:

- equip the centre with specific tools to make these actions automatic or compulsory (isolation barrier, footbath for the disinfection of feet/footwear etc.);
- inform people (with notices, via the personnel) of the reason for and nature of these actions (how and why);
- monitor these actions and make them compulsory, since people tend to avoid following rules.

The structure and capacity of the centre depend on the attack rate of the epidemic, which is estimated according to the context (Table 14.III and Box 14.1).

### 5.1 Planning

In order to act as quickly as possible, and be sure to meet all needs, the opening of the CTC can be done in successive stages. For an estimated maximum capacity of 300 patients, three separate openings of structures for 100 sick people each can take place. The peak of the epidemic usually occurs after 3 to 4 weeks, so it is necessary to plan one phase per week so that capacity is not exceeded\*.

#### Box 14.1

Example of CTC in North Mogadishu, 1994.

##### *Estimate*

Affected population = 500 000 in a 'natural' environment (no large camps).

Total number of patients:  $A_t = 1\%$  of the population = 5 000.

Number of daily admissions:  $D_a = 2.6\%$  of  $A_t = 130$ .

Capacity of the CTC:  $C_m = 4 \times 130 = 520$ .

Total HTH consumption = 2 000 kg.

##### *Achievements (actual)*

$A_t = 4\ 900$  (the CTCs treated 3 900 patients, of whom about 1 000 were treated in 6 small structures).

$D_a = 105$ .

$C_m = 350$ .

##### *Area of the CTC*

$C_m = 350$ .

– site  $350 \times 15 = 5\ 250\ m^2$

– or building of  $350 \times 5 = 1\ 750\ m^2 + 500\ m^2$  for sanitary installations.

##### *Water*

$70 \times 350 = 24\ 500\ l/day$ .

\* An overcrowded installation, originally planned for 100 patients, can work for a few days with 120-130 patients, but it quickly becomes unmanageable with 150.

**Table 14.III: Key quantities.**

These quantities are only estimates developed using ACF's experience in the field: they can help to establish a realistic budget, and to choose a large enough location for the CTC.

Average hospitalisation time can be reduced to 3 days if doxycycline is used in single dose, and if patients are hospitalised at a stage of moderate dehydration (ease of transport or concentrated population, and good coverage by home visitors). It can increase to 5 days if antibiotic therapy is carried out during 3 days, if the centre is not very accessible (distance, no security at night etc.) and if it receives a high proportion of serious cases. Finally, good preparation (an intervention plan), efficient coordination and a sufficient drinking-water supply reduce hospitalisation times.

Aspect	Rough estimate of quantity
Total number of patients to be treated	At = 1% of the total population At = 2% in areas at risk (camps)
Number of daily admissions	Da = 5% of At for At = 500 Da = 3% of At for At = 3 500 Da = 2.6% of At for At = 5 500
Capacity of the CTC	Cm = 4 x Da
Area of the CTC	For a new site: 15 m <sup>2</sup> /patient For buildings: 3 to 5 m <sup>2</sup> /patient + 500 m <sup>2</sup> for sanitary installations Equal distribution between ORS and IV phases
HTH consumption	Daily: 1 kg/10 patients Total: HTH kg = 4 x At/10
Water consumption	60 to 80 l/patient/day
Chlorine solutions used in the centre (see Section 5.5)	Solution A: 2% chlorine Solution B: 0.2% chlorine Solution C: 0.05% chlorine

Extensions must be built without disturbing the centre's work – only patients in the ORS phase (see Section 5.3) can be moved. More often than not it's the sanitation works that delay the extension of the centre: therefore these can be carried out in advance, and no extension should be opened if the sanitary installations are not ready. On the other hand, the tents must be erected as needed (always one in reserve).

It is better to build some basic structures quickly, even if it means having to improve them later on. In any case, it is necessary to avoid building a small paradise (in relative terms) which patients do not want to leave (especially if there is food), and where the patients' families come to have a shower.

## 5.2 Choice of site

### *Area*

Related to the maximum capacity, Cm (see Table 14.III).

### *Location*

Easy access for everybody, near the centre of the epidemic area concerned if possible, but sufficiently far from centres of people at risk (schools, orphanages, camps etc.).

Isolation from the outside (enclosure wall, thorns, wire fencing etc.).

Access to trucks – essential during construction (materials) and operation (water tankers etc.).

### *Building*

There are no absolute rules.

A new site requires intensive construction work (erecting tents, plastic shelters etc.), but it also offers greater design freedom, approaching the ideal. During the rainy season, drainage must be given careful attention. This is usually the NGOs' option for large centres.

Installation in an existing permanent building, which is often in poor condition, imposes certain construction limitations, but allows a quick start to activities. It is generally the option chosen by health authorities and/or NGOs for small centres.

*Water supply*

Ideally, choose a site with a reliable water point (well, connection to distribution system etc.).

In the absence of water points, organise the distribution of water by tanker.

Verify the flow of existing wells or boreholes to check whether the yield is sufficient.

Install an elevated water-storage tank in order to distribute the water by gravity.

*Sanitation*

Install latrines, excreta-disposal pit and showers.

Take particular care with drainage of wastewater.

Check for contamination of nearby water points.

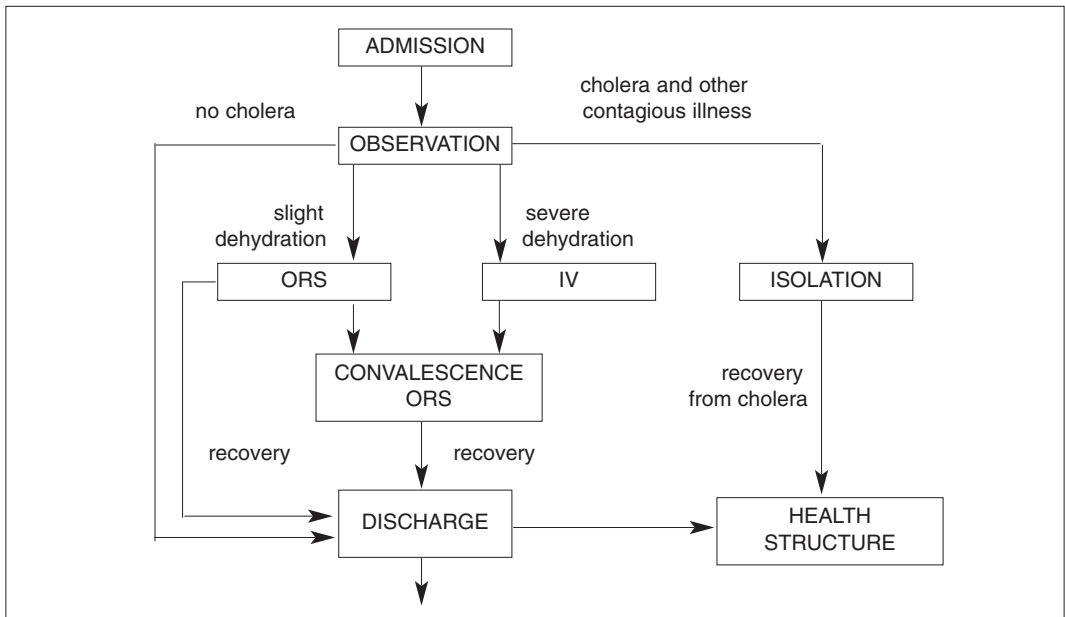
Maintain a minimum distance of 30 m between sanitary structures and groundwater abstraction points (may vary depending on hydrogeological conditions).

*Electricity*

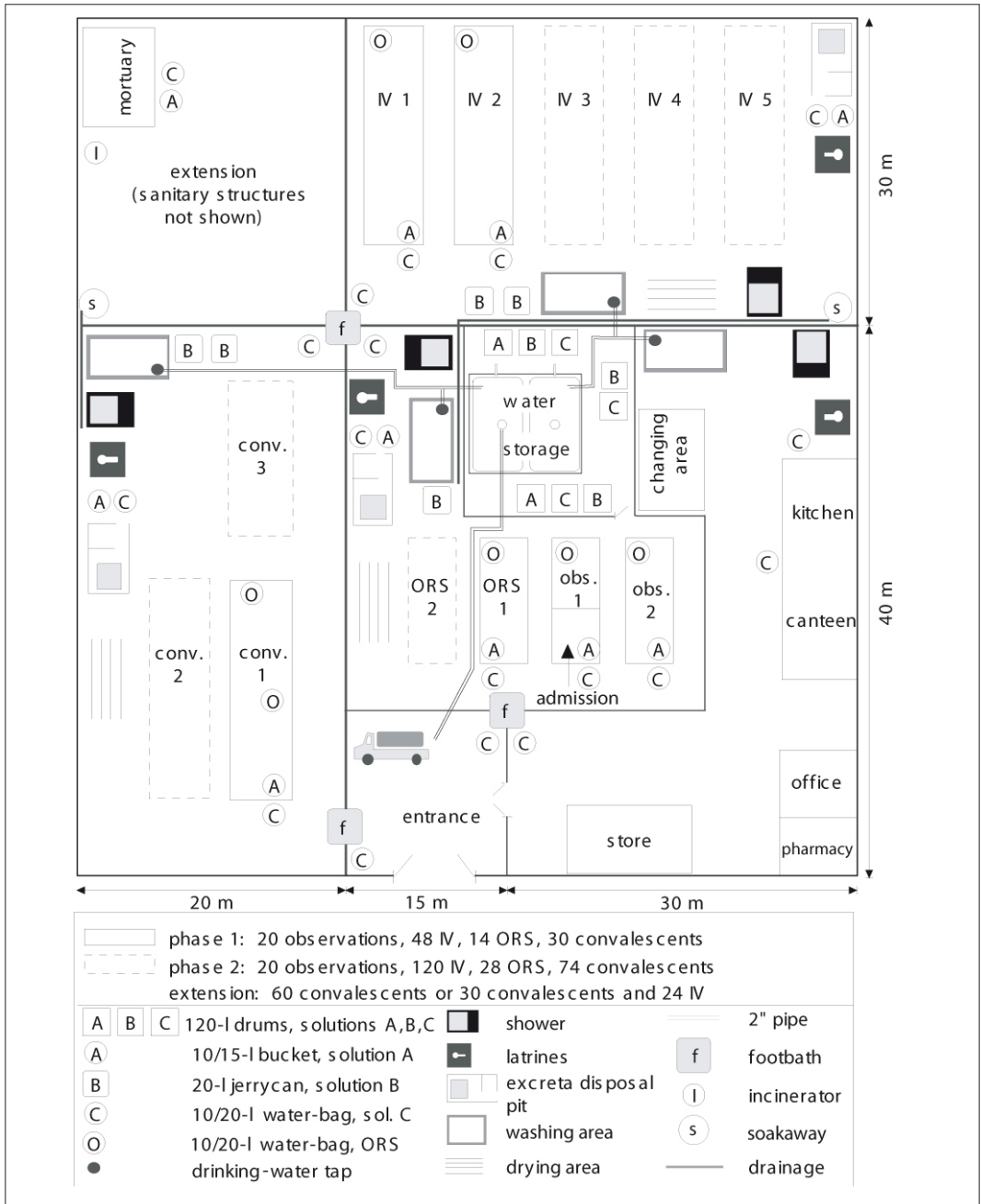
This is a bonus, especially if an electric pump has to be used on a well. A generator is not essential if electricity is to be used only for lighting (oil lamps and electric torches are adequate).

### 5.3 Layout of a CTC

The layout principles depend upon the medical and sanitary constraints which can be represented by the different routes that patients take in the centre (Figure 14.4). All areas must be differentiated and isolated from one another, and they must be arranged so as to reduce movement of people in the centre to a minimum (Figure 14.5 & Table 14.IV).



**Figure 14.4:** Patient progressing through a CTC.



**Figure 14.5: Plan of a typical CTC for 300 patients.**

The patients arrive at admission (registration) and then, after a possible stay in observation, are:

- sent to another health structure if they do not have cholera;
- treated in the isolation section if they have cholera and another contagious disease (tuberculosis, measles, hepatitis etc.);
- treated in an ORS area, and then discharged if they are not seriously dehydrated;

– treated in the IV area if they are seriously dehydrated (separation provided for children and pregnant women), and then in convalescence/ORS and discharged (or taken to the mortuary).

The duration of stay at the centre is around 3 days for patients admitted directly to an ORS area, and 5 days for those admitted to an IV area and then transferred to an ORS area.

**Table 14.IV: Zones and sanitary equipment of a CTC.**

Zone	Sanitary structures
<i>Admission/Observation</i>	
Entrance to the centre: all new patients are registered and directed to the area corresponding to their condition ( <i>Observation, ORS or IV</i> )	Footbath Drinking-water point Chlorine-solution points
Plan 1 or 2 tents with space for 10-12 people each	Latrines
The observation area for uncertain cases is located near to admissions (in the same tent)	Excreta-disposal pit Showers
Average duration of stay - 1 day	Clothes-washing slab
When possible, patients move to the treatment area or are discharged	Waste-bins Stretchers to transfer non-cholera patients and for internal transport – to be differentiated! In every tent: ORS point + hand-washing water-bag C + bucket A
<i>ORS rehydration (part of the Admission/Observation area)</i>	
Initially, patients with moderate dehydration (grade A and B) are treated in the ORS structures of the Admission/Observation area.	
Plan for 2 tents with space for 10-12 people	
<i>IV Rehydration</i>	
Patients with serious dehydration (grade C or B with vomiting) (also very contagious)	Beds for cholera patients Drinking-water point
To facilitate the work of the personnel and the organisation, units of 20-25 (tents, shelters, wards) mounted progressively	In each tent: ORS point + hand-washing water-bag C + bucket A
Plan 4-5 m <sup>2</sup> per patient	Points for chlorine solutions A and C, inaccessible to the public
Children, who are usually the most vulnerable and seriously affected, are collected into paediatric units	Clothes-washing slab with barrel of solution B
As soon as rehydration by ORS is possible (after 1 to 2 days), the patient is transferred to the <i>Convalescence/ORS</i> area	Latrines Excreta-disposal pit Showers Footbath
The incinerator and mortuary are located in the IV area (or in the area planned for the last extension).	Waste-bins
<i>Isolation (part of IV rehydration area)</i>	
A small isolated tent in the IV area houses those patients affected by cholera and another contagious disease	
Another unit is reserved for pregnant women, to manage childbirth, postnatal care, and miscarriages (frequent with cholera); a simple screen can be used to isolate from the other patients visually	
<i>Convalescence/ORS</i>	
Patients in the recovery phase	Drinking-water point
Mats and plastic sheets under large tents or shelters (30 patients): 3-4 m <sup>2</sup> /patient	In each tent: 2 ORS points + hand-washing water bag C + bucket A
Normally, the patient can go to the latrines: excreta-disposal pits are planned for new arrivals treated with ORS	Chlorine solution points A and C, inaccessible to the public
Generally after 3 days (but never before the end of the antibiotic treatment), the patients are discharged and must leave the centre	Clothes-washing slab with barrel of solution B Latrines Excreta-disposal pit Showers Footbath Waste-bins

**Table 14.IV: Zones and sanitary equipment of a CTC.**

Zone	Sanitary structures
<p><i>Mortuary</i></p> <p>Bodies are cleaned with solution A, and then wrapped in a large cloth sprayed with the same solution</p> <p>The wrapped body can be placed in a large plastic bag or a piece of plastic sheeting for transport: this contaminated plastic must be recovered by the undertaker</p> <p>The majority of bodies are collected by the family, who take care of the burial</p> <p>For uncollected bodies, plan a place to bury them on-site, or make arrangements with the community (see the authorities)</p>	<p>Bucket A + water-bag C</p> <p>Stretchers (a minimum of 3)</p> <p>Solution A sprayer</p> <p>Solution B sprayer</p>
<p><i>Neutral area</i> (accessible only to personnel)</p> <p>Warehouse for sanitary products, food and rehydration products (Ringer' lactate (very bulky) and ORS)</p> <p>Dispensary (2 days of stock) is a closed area (if possible the one permanent building on site, otherwise a tent)</p> <p>Daily re-supply from an external stock in case of poor safety</p>	<p>Drinking-water point</p> <p>Point for solutions B and C</p> <p>Showers</p> <p>Latrines</p> <p>Footbath</p>
<p><i>Office for the administrator, expatriates, supervisors, etc.</i></p> <p>A canteen for personnel (to eat, drink tea etc.), which doubles as a meeting room</p> <p>A changing-room for the personnel (to change clothes and disinfect working clothes)</p> <p>There are several possibilities for meal preparation:</p> <ul style="list-style-type: none"> <li>– food for patients, carers and personnel prepared in a kitchen <ul style="list-style-type: none"> <li>• it limits the coming and going of food carriers, but</li> <li>• it leaves the door open to abuse, and is an expensive solution (200 patients + carers + personnel = 500 meals)</li> <li>• it uses logistics resources and energy</li> <li>• it does not facilitate the departure of patients who have recovered</li> <li>• this is a solution to be avoided</li> </ul> </li> <li>– meals for patients and personnel prepared in a kitchen <ul style="list-style-type: none"> <li>• good organisation</li> <li>• a less costly solution than the previous one</li> </ul> </li> <li>– no kitchen <ul style="list-style-type: none"> <li>• feasible at the start-up</li> <li>• involves visitors coming and going, and requires reinforcement of disinfection and control systems at the entrance</li> <li>• no food going out (since it is assumed to be contaminated), disinfection of dishes</li> <li>• to be retained if too much energy used in establishment and management, or if storage of food is dangerous</li> </ul> </li> </ul>	

## 5.4 Water supply

A supply of 60 to 80 l/patient/day is necessary.

Drinking-water must be chlorinated to obtain 0.5 mg/l of free residual chlorine at the tap. This chlorination is done in the tank.

In addition to this, three different chlorine solutions are used in the centre:

- solution A (2% chlorine), used to disinfect patients' stools and vomit, and dead bodies.

Storage period one week;

- solution B (0.2% chlorine), used to disinfect beds, stretchers, clothes, eating utensils, the patients' homes, and vehicles (spray). Storage period one day;

- solution C (0.05% chlorine), used to disinfect skin (mainly hands). Storage period one day.

Preferably, these solutions should be prepared with HTH, which has a strong concentration of chlorine, and keeps well. Otherwise, and only as a provisional measure, they may be made with any product containing chlorine (see Chapter 12). It is essential to establish a chlorination protocol for staff to follow.

### 5.4.1 STORAGE

Ideally the water-storage tank (capacity equal to daily consumption) is located on an elevated site (mound or embankment) in the middle of the centre: this facilitates concentration of all sanitary structures and simplifies their supply with water and chlorine solutions, and rationalises drainage.

The water tank can nevertheless be placed outside the centre, as long as it is well protected by a fence.

### 5.4.2 DISTRIBUTION

Distribution to the water points (each with 1 or 2 self-closing taps) is gravitational, via 2" semi-flexible reinforced pipes (low head loss). If some parts of the centre cannot be served by gravity, 1-m<sup>3</sup> plastic tanks, placed at a height and periodically refilled with a motor pump, are used instead.

## 5.5 Sanitary facilities

### 5.5.1 FOOTBATHS AND HAND-WASHING FACILITIES

These are the compulsory entry-and-exit route between the different areas of the CTC, to ensure disinfection of shoe soles and feet (footbath, solution B– Table 14.III) and hands (hand-washing facilities, solution C). They provide sanitary barriers and control people's movement.

A footbath technician is always on duty to:

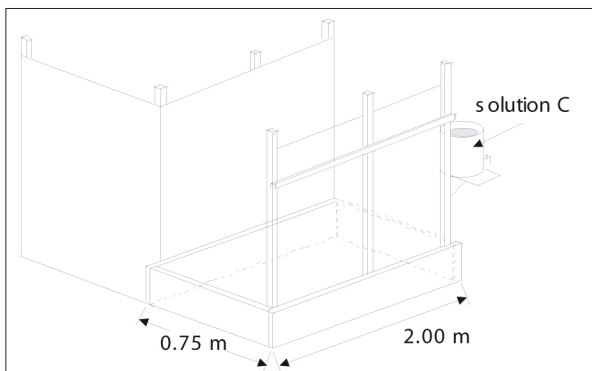
- check disinfection;
- make sure that people pass through the footbath fully. Solution B can discolour and even damage shoes, and it becomes muddy and unpleasant quite quickly;
- inform and convince people that a small inconvenience is better than a large problem.

It must not be possible to avoid the footbath, which should be filled with a maximum of 2 cm of liquid. The solution must be renewed when it becomes too muddy: laying gravel, at least on the paths, improves the situation. To empty the footbath, a small soakaway at the side, or a concrete pit, can be considered.

At the doors of buildings, plastic basins with some solution at the bottom can be used. Jute sacks soaked in solution are not acceptable, because they quickly become clogged with mud and dust, and are difficult to clean.

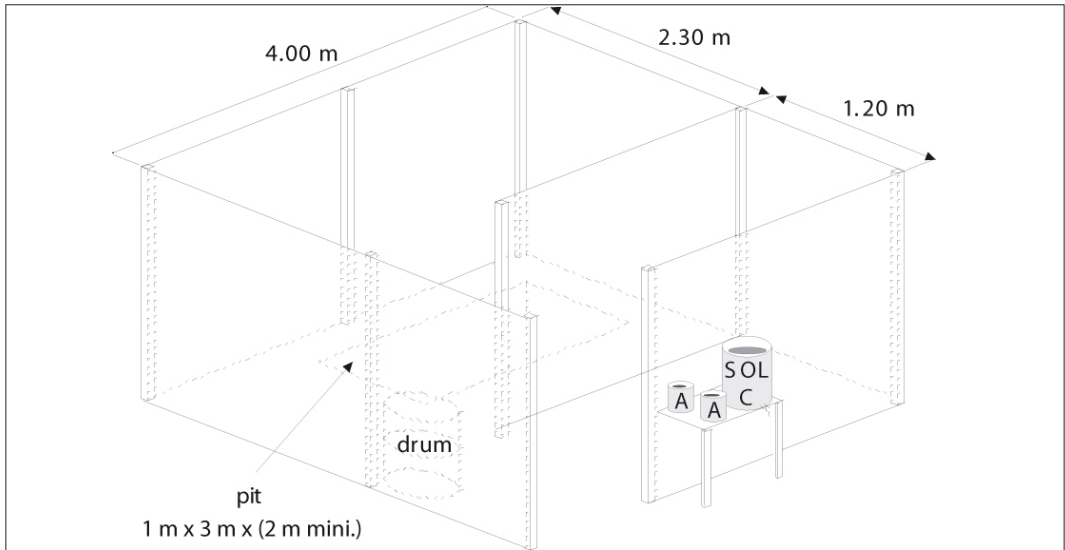
The personnel of the centre must be equipped with boots to avoid the irritation caused by repeated contact with chlorine.

The hand-washing facilities are placed by the footbath, on the inward side. They usually consist of a jerrycan of 10 to 20 l (or, even better, a water-bag), equipped with a tap, filled with solution C and placed on a shelf or stool (Figure 14.6).



**Figure 14.6: Footbath and hand-washing facility.**

**Materials: 4 pieces of sheet metal (10 x 200 cm), 5.5 m planking (20 x 2 cm) (+ 8 m if base is to be of wood), 8 posts (4 x 200 cm). Plastic sheeting 2.5 x 1.25 to cover the base.**



**Figure 14.7: Example of excreta-disposal pit.**

**Materials (without roof): posts, 27 m (8 x 8 cm), 36 m (4 x 8 cm). Plastic sheeting, 36 m<sup>2</sup>.**

### 5.5.2 EXCRETA-DISPOSAL PIT

This is not a standard latrine (see Chapter 13), but a structure for disinfecting the stools and vomit of patients in the IV, observation and ORS sections.

In general, patients are incapable of controlling themselves or walking to a toilet initially, and use a bucket at best. Their carers must then empty the contents of the bucket into a plastic barrel (50-100 l), situated by the excreta-disposal pit (Figure 14.7). Then the bucket must be completely rinsed with 0.5 l of solution A: this disinfection solution is also poured in the barrel. Pouring the solution in the barrel leaves chlorine enough time (20 to 30 min) to act on the faecal matter, after which only decontaminated waste will be poured into the pit. Carers leave after having washed their hands with solution C at the exit. An employee on duty must explain to all new arrivals how the pit works, and help them if necessary.

### 5.5.3 LATRINES

Standard temporary simple latrines (see Chapter 13) are reserved for carers, personnel, and patients in the convalescent phase (rehydration by ORS).

Solution C is available by the latrines for hand-washing and anal cleansing. The latrines are regularly disinfected (sprayed with solution B) and cleaned with solution A.

### 5.5.4 SHOWER

A concrete slab draining into a soakaway (see Chapter 13) is more functional than a simple layer of gravel, because it is easier to clean and disinfect by spraying solution B.

### 5.5.5 INCINERATOR

Medical waste (ORS sachets, Ringer's lactate packaging, needles etc.) is collected and burned in an incinerator.

The combustion residues are dumped in a narrow, deep pit.



### 5.5.6 ORS POINTS AND HAND-WASHING FACILITIES

These consist of plastic recipients fitted with a tap and filled with various solutions.

The ORS points are located inside the wards, and contain chlorinated water in which the rehydration salts are dissolved.

For hand-washing facilities outside the buildings, 10 to 20 l of solution C should be provided.

### 5.5.7 WASHING AREA

A barrel of 100 to 200 l of solution B and some basins for soaking laundry are provided for this purpose.

A cement slab and a small channel running towards a soakaway are essential.

The laundry hanging and drying areas must be covered during the rainy season.

Finally, a hand-washing point, containing 10 to 20 l of solution C, is located at the exit.

### 5.5.8 SOLUTION PREPARATION FACILITY

Whenever possible, a single point near the water tank is reserved for this purpose. By having centrally-located storage and preparation points, transport of water and solutions is kept to a minimum. Plastic barrels of 100 to 200 l, provided with taps and placed on tables, are used.

The barrels of solution B are directly accessible to the public (for clothes-washing), whereas the barrels containing solutions A and C are only for personnel who come to refill smaller containers.

A (daily) stock of HTH is kept in a well-ventilated box, locked and in the shade, with an entry/exit log.

#### **Table 14.V: List of minor equipment needed.**

---

2 buckets per patient in the IV phase, 1 for the stools and usually 1 for vomit, both re-usable

Plan a margin in relation to the maximum capacity of the IV section (half of the maximum capacity of the centre):  
number of buckets = 1.2 maximum capacity of the centre

Buckets with a cover for solution A (1 per unit)

Buckets for showers

1 cholera bed per each patient in IV or observation phases, or individual plain plastic sheets (0.70 x 2 m)

Basins for clothes-washing with a capacity of 20 to 50 l

Mats or plastic sheets for patients in ORS phase (2 m<sup>2</sup>): the cured patients feel less tempted to take small sheets with them

Table (for medical items) and stool (personnel, hand-washing facilities) in each IV unit and in each area (ORS, Observation, Admission, staff room, office)

10 to 20-l plastic barrel or water-bag, fitted with a tap, for the hand-washing facilities C: 1 for 20-25 patients in IV phase, 1 for 40-50 patients in ORS phase, 1 for each footbath, latrine and excreta-disposal pit, and 1 each for the kitchen and canteen

10 - 20-l plastic barrel or water-bag, fitted with a tap, for the distribution of ORS:

1 for 20-25 patients in IV and Observation phases

2 for 30 patients in ORS and Convalescence phases

120 to 200-l plastic barrels fitted with taps for the preparation of solutions A, B, and C

If necessary, 500-l plastic barrel or 1-m<sup>3</sup> water tank as a reserve for outer areas

---

### 5.5.9 MINOR EQUIPMENT

All the equipment necessary (Table 14.V) must be marked (place of usage and contents; for example: *IV2/solution A*) with an indelible marker, and managed by the person in charge, the sanitary technician who uses them.

### 5.5.10 DRAINAGE

The high consumption of water means that large quantities of wastewater must be disposed of. It is therefore necessary to plan the general drainage of the centre.

If the showers, water points and washing areas are concentrated, it is simple to collect wastewater into a system of small channels that transport it quickly and without stagnation, even if the slope is slight.

The size of the soakaway depends on the permeability of the ground: if it is low, several soakaways must be planned; alternatively, infiltration trenches may be dug.

Small soakaways are also necessary for the hand-washing facilities, footbath waste outlets, and cleaning-water from the tents. To avoid filling the soakaways with soap and grease, it is essential to install simple grease traps.

A network of drains around the tents removes rain water towards a ditch in a natural low point.

## 5.6 Shelters

The shelters can be simple tents, or alternatively they can be built with plastic sheeting (the tents are retained for future extensions).

It is essential to lay a plastic groundsheet, easy to wash and disinfect periodically. A small central channel leads the washing-water to a soakaway.

The shelters must be sprayed with a persistent insecticide (e.g. deltamethrine) before being used. Gravel paths, roofs over all sanitary installations, and good rainwater drainage, must all be provided during the rainy season.

## 5.7 Sanitary barriers

The purpose of these barriers is to avoid contamination from inside or outside the centre.

To avoid contamination of the outside:

- it is essential to isolate the centre with walls, fences, or barbed wire, with a single entrance/exit. A second exit, padlocked, is only used for the removal of bodies of deceased patients;
- the limitation of movement means that it is only possible for one relative to accompany every patient;
- everyone leaving the centre must wash their hands (solution C), disinfect their soles/feet in the footbath (solution B) and, when necessary, disinfect their dishes (solution B);
- stretchers and vehicles that have transported sick people must be thoroughly disinfected.

Inside the centre:

- at the entrance/exit of each unit (IV, ORS, Admission etc.), disinfection of soles /feet (footbath - solution B) and hands (solution C);
- disinfection of patients' stools and vomit, as well as the buckets used to contain them (solution A);
- disinfection of dead bodies (solution A), and isolation in plastic bags;
- disinfection of latrines (regular spraying and cleaning with solution B; occasionally with solution A);
- disinfection of patients' clothes (solution B), burning them if possible in the most serious cases;
- disinfection of eating utensils (solution B) and then rinsing with water.

## 5.8 Management

### 5.8.1 ORGANIGRAM

The organigram is shown in Figure 14.8.

#### 5.8.1.1 Expatriate personnel or Senior staff

Expatriates and other senior staff play a fundamental role in the recruitment, training, organisation and supervision of local personnel. Their presence and numbers are decisive when starting up a centre, decreasing rapidly in the case of logistics personnel, and more slowly in the case of medical staff, depending on the development of the epidemic. To start up a high-capacity centre, five senior staff are essential:

- 1 in charge of building and supply logistics,
- 1 in charge of sanitary aspects,
- 3 medical staff (one must be a physician).

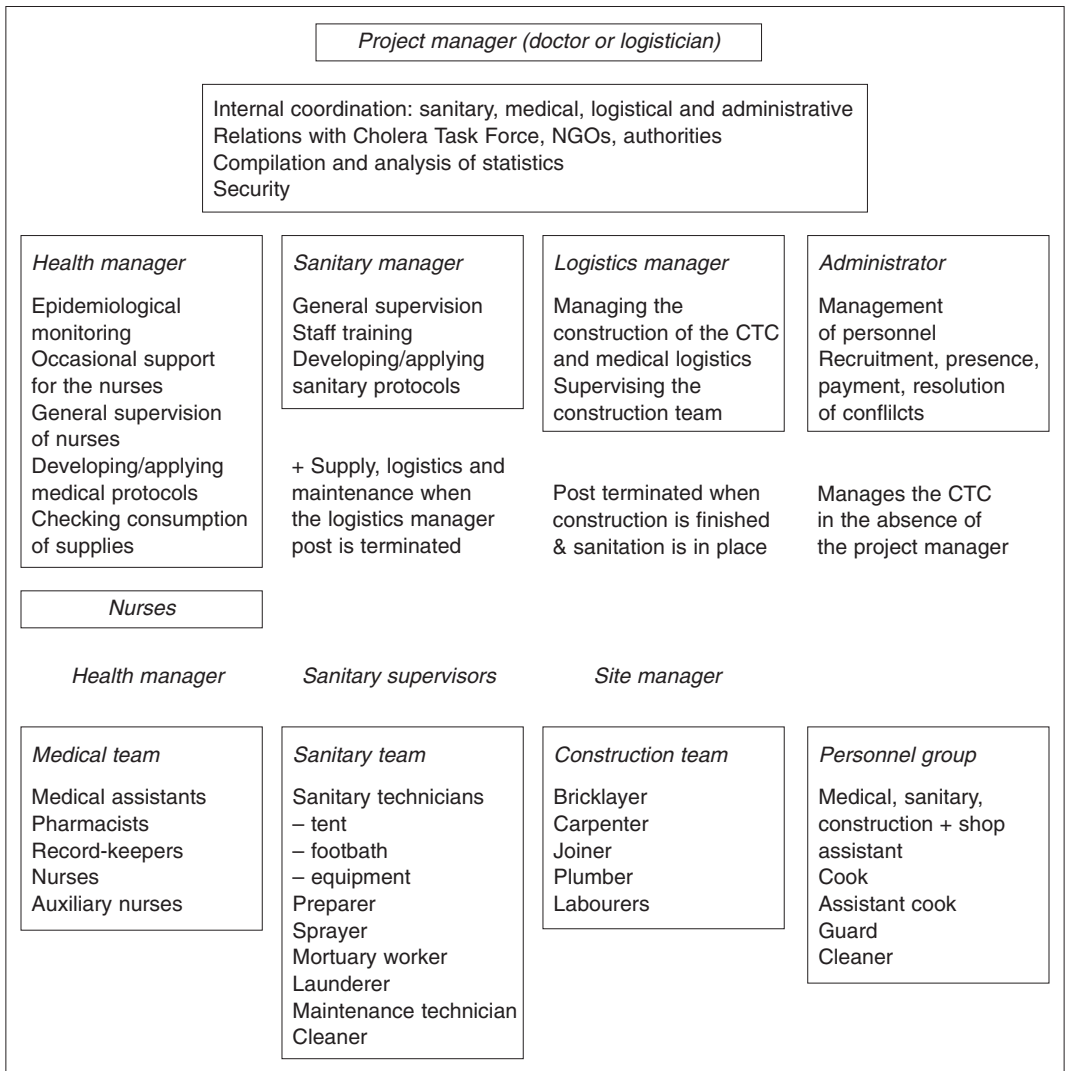


Figure 14.8: Personnel chart for a CTC.

In certain cases, for very large operations, a project manager may be needed for coordination. All roles must be clearly defined. In particular, one member of the team, for example a logistician or a physician, must be in charge of daily meetings, work with the administrator, and external relations.

Progressively, the team will be reduced to one or two people (logistician and physician).

#### *5.8.1.2 Local personnel*

Everyone working at the centre must be given a job description, covering their tasks, personal equipment, list of equipment for which they are responsible, their timetables, allowance (money or food-for-work) or salary, and a reference to the internal regulations. This document is signed by both parties, and can easily be transformed into a work contract if legislation permits.

Successful round-the-clock operation of the centre, which guarantees low mortality and limitation of the epidemic, always depends on the medical and sanitary personnel. These people have the difficult task of looking after patients and their carers, informing them, and encouraging them to perform essential tasks (hand-washing, use of latrines etc.). Furthermore, this must be done constantly, because of the constant turnover of patients and carers.

From the beginning of the project it is necessary to recruit a competent local administrator to take part in the recruitment of personnel, establish the personnel list, manage them daily, and pay them. This person also resolves conflicts, and manages the whole centre when the expatriate manager is absent.

Finally, it is necessary to plan daily timetables for 24-hour operation.

### 5.8.2 DESCRIPTION OF SANITARY POSTS

#### *5.8.2.1 Sanitary supervisor*

One person:

- supervises the work of all sanitary personnel;
- manages the water supply;
- refers to the expatriate sanitary manager, who takes the decisions needed for improving the work, in collaboration with the sanitary supervisor;
- withdraws HTH from the storekeeper, and checks its consumption on the file;
- temporarily replaces a person absent from the team (especially the person who prepares solutions).

#### *5.8.2.2 Preparer of solutions*

- prepares solutions A, B, and C for the various units;
- manages the water supply (supply, treatment);
- receives HTH from the supervisor and keeps a file of entry and production of solutions.

Above a certain volume of activity, the preparer is helped by an assistant, capable of taking over if necessary; this assistant ensures the supply of solution B and C at the footbaths.

#### *5.8.2.3 Sanitary facilities technician*

One person per set of facilities:

- in charge of the latrines, excreta-disposal pits, showers and washing areas;
- specifically in charge of the disinfection of stools and vomit in the excreta-disposal pits, explains procedure to patients and visitors, or carries them out personally, if necessary;
- keeps containers of solution A (0.5 l) and hand-washing facilities filled with solution C at the entrance to latrines and excreta-disposal pits;

- periodically empties the barrel of disinfected matter into the excreta-disposal pit;
- makes sure that showers, latrines and washing slabs are used correctly;
- supervises the jobs of the cleaner and sprayer.

#### *5.8.2.4 Tent sanitary technician*

One person for 20 to 25 patients in IV and Observation phases.

One person for 30 to 50 patients in ORS and Convalescence phases.

This technician, who is the first contact for carers and patients, has an essential role:

- informs the patients and carers about cholera contamination modes;
- explains the various measures for reducing transmission: disinfection of stools, vomit, hands, soles, clothes, dishes etc. with chlorine;
- also explains how to use the various facilities (excreta-disposal pit, footbath etc.);
- provides one or two buckets per patient, explains how to use them and makes sure that they are properly used;
- refills the small barrels of solutions A and C from the storage barrels;
- may have to prepare ORS (substituting the ORS area nurse);
- following medical advice, transports patients to the Convalescence area with the help of maintenance workers;
- supervises the sprayer and the cleaner.

#### *5.8.2.5 Tent cleaner*

One person per 25 patients in IV and Observation phases, one for 50 in ORS and Convalescence phases:

- keeps the unit clean (rubbish – waste-bin);
- disinfects (with solution A) any place that has been soiled (bed, ground, mat etc.);
- is at the disposal of the sanitary technician and nurses to give them any help they may need.

#### *5.8.2.6 Sprayer*

One person for 50 patients in the IV area, and one for the Convalescent area.

One person for the Observation/ORS area (plus one in the Admission area when the number of admissions is more than 30-40):

- uses solution B;
- sprays inside and outside the tents, especially in soiled places;
- disinfects beds and mats (especially after the discharge or transfer of patients);
- regularly disinfects latrines and showers.

#### *5.8.2.7 Entrance sprayer*

One person at the main entrance (solution B):

- sprays soles/feet, dishes and objects that people going out may be carrying;
- sprays vehicles, stretchers, cloths and any other item in contact with new patients during their transfer to the centre.

#### *5.8.2.8 Sanitary technician/sprayer of the Neutral area*

One person, who works only during the day:

- is responsible for all the sanitary equipment of this area;
- disinfects the clothes left in the changing room.

### 5.8.2.9 Footbath sanitary technician

One person for each footbath:

- is responsible for the footbath (availability of solutions);
- limits the entry of visitors;
- makes sure that people going out disinfect their hands (solution C) and feet (solution B).

### 5.8.2.10 Maintenance worker

Two people, who work only during the day:

- collect all the waste-bins and burn the waste;
- are available for carrying out odd jobs (stretcher-bearing, maintenance etc.).

**Table 14.VI: Summary of sanitary personnel for a CTC with a maximum capacity of 300 people. With the centre working 24 h/24, three teams with the same composition follow one another on a 3 x 8 basis (or rather 7 + 7 + 11 h 30, including crossover times, bearing in mind the lower rate of night-time activity). Each week, the teams can change timetables, in order to balance the number of work hours. In a centre with 300 patients, there are therefore 67 sanitary technicians at the start-up of the centre, and 118 at the peak of the epidemic.**

Job	Number or ratio	Number at start-up	Number at max. capacity
<i>24 h/24 team</i>			
Sanitary supervisor	1	1	1
Preparation of solutions	1 + 1 Asst.	1	1 + 1
<i>IV</i>			
Sanitary facility technician	1 per facility	1	2
Tent sanitary technician	1 per 20 to 25 patients	2	6
Footbath sanitary technician	1	1	1
Tent cleaner	1/ per 0 to 25 patients	2	6
Sprayer	1 per 50-patient unit	1	3
<i>Convalescence</i>			
Sanitary equipment technician	1 per facility	1	1
Tent sanitary technician	1 per 50 patients	1	3
Footbath sanitary technician	1	1	1
Tent cleaner	1 per 50 patients	1	3
Sprayer	1	1	2
<i>Admission/Observation/ORS</i>			
Sanitary equipment technician	1	1	1
Tent sanitary technician	1 per 25 patients	1	2
Footbath sanitary technician	1	1	1
Tent cleaner	1 per 50 patients	1	1
Sprayer	1	1	1
<i>Entrance</i>			
Sprayer	1	1	1
<b>TOTAL</b>		<b>20 x 3 = 60</b>	<b>37 x 3 = 111</b>
<i>Only during the day</i>			
Sanitary technician / Neutral-area sprayer	1	1	
Maintenance worker	2	2	2
Mortuary worker	2	2	2
Laundry worker	2	2	2
<b>GENERAL TOTAL</b>		<b>67</b>	<b>118</b>

#### 5.8.2.11 Mortuary worker

Two people (one man and one woman), who work only during the day:

- transport the deceased to the mortuary, plug all orifices (cotton impregnated with solution A), clean the bodies with solution A, and wrap them in a shroud and then in a plastic sheet or bag;
- if the family members wish to clean the body, they explain the need for this procedure, and supervise it;
- make sure that the family members disinfect themselves after touching the body;
- urge the family of the deceased to bury the body as quickly as possible;
- monitor the funeral.

#### 5.8.2.12 Laundry workers

Two people, who work in the IV area, only during the day:

- disinfect (10 min soaking in solution B),
- and then wash the centre's cloths and blankets.

### 5.8.3 RECRUITMENT AND TRAINING

As soon as the layout and equipment of the centre have been determined by the medical personnel and the logistics manager, the main task of the sanitary manager is to recruit and train personnel. It may take eight to fifteen days between the job announcement and the recruitment of 75 sanitary technicians ready to work. This is also the time necessary for recruiting and training the medical team.

#### 5.8.3.1 Staff profiles

In the first place, people with some experience in public health, teachers who are not afraid of getting their hands dirty, and people whose information and advice will be well accepted by those concerned, will be preferred.

Other criteria vary depending on the post:

- supervisor: good understanding of water supply and sanitation, team leader, 'presence' (person of a certain age), clear expression, good knowledge of an international language;
- preparer of solutions: understanding of health information, ability to do calculations, sense of responsibility, international language;
- tent sanitary technician: knowledge of health information training / explaining skills, international language if possible;
- sanitary facilities technician: knowledge of health information, authority, training / explaining skills, international language if possible;
- footbath sanitary technician: authority, knowledge of health information;
- mortuary worker: knowledge of health information, training / explaining skills;
- sprayer: previous experience, technical skills;
- cleaner, laundry worker, maintenance worker: ability to act in any context.

#### 5.8.3.2 Training

The training involves theoretical, technical, and practical sessions.

Theoretical training (half a day per group) gives a knowledge of cholera and its modes of contamination and disinfection. It is intended to motivate personnel to apply and maintain actions they may normally regard as bizarre. A previously-trained supervisor can simplify this training for the group of cleaners-sprayers.

The technical and practical training (half a day per group) begins with a reminder of the theory, which is followed by a presentation of the plan of the centre and its medical and sanitary functions.

A visit to the centre, during which the various jobs are explained, is organised. This training finishes with a presentation of the internal regulations.

At the end of this general training, job appointments are established and the candidates are informed. The three teams (morning/day/night), and their respective supervisors, are chosen. From that moment on, the work is done by groups of work posts, under the responsibility of supervisors. These supervisors are not always immediately appointed, but chosen after some days of work, except when training has been long and comprehensive enough to identify leaders. A detailed job description must be drawn up:

- making the person concerned responsible for materials and equipment used during their shift;
- identifying the supervisor as responsible for the sanitary team;
- making it clear that appointments are not permanent, and can be modified at any time.

In urgent cases, where a centre must be opened immediately (even if the installation is not complete), a reduced team is quickly recruited, and trained on the job, using the job description as a basis. In this case the practical training must be complemented by close supervision. Theoretical training takes place later.

#### 5.8.4 INFORMATION

Inside the centre, posters are placed in front of each sanitary point to facilitate the quick uptake of hygienic practices, and to avoid any improper use of the solutions. These posters must describe, with simple and unambiguous drawings, the operation to be carried out: drinking, washing hands, doing washing etc. A local artist is perfectly adequate for the task of portraying these messages.

Outside, messages broadcast to the population by all media (radio, television, newspapers, religious gatherings etc.) deal in general with preventive hygiene measures, and what to do to combat the disease. It is advisable to complement these messages with some information about the treatment centres, insisting especially on the reasons for, and the importance of, measures such as the limitation of the number of carers, systematic disinfection at the exit etc. These restrictive measures are generally better accepted coming from local or religious authorities.

### 5.9 Other structures and contexts

For other cases (use of a building, or low-capacity centre), the principles are the same as those already mentioned, with exceptions that must be applied to each particular case.

#### 5.9.1 BUILDING

If the capacity of a building is not sufficient, inside space is allocated as a priority to the dispensary and to patients in the IV phase.

Even though a tiled floor facilitates periodic disinfection of the building, it is nevertheless necessary to provide some basins for collecting wastewater.

Specific sanitary facilities (toilets, excreta-disposal pits, and showers) are built for cholera treatment.

#### 5.9.2 LOW-CAPACITY CENTRE

A low-capacity centre is usually set up in a permanent building. The sanitary facilities are simplified, retaining:

- one or more 250-litre plastic reservoir(s) for water storage;
- some 20-litre containers for preparing and storing chlorine solutions;
- plastic basins for footbaths.



In addition, a smaller number of staff are required, and they are less specialised: the supervisor prepares solutions, the sanitary technician sprays etc.

If there is no available site for the sanitary facilities, the building's toilets can be used, reserving one for patients in the IV phase. The disinfection procedure is then carried out in a small barrel, which is periodically emptied into the toilet. The latter must never, under any circumstance, be used directly by patients, especially if it is connected to a sewage network. This kind of arrangement is not really advisable, but may be unavoidable if an existing CTC or health structure is used.

Patients in IV and ORS phases must be kept isolated as much as possible.

## 6 Actions in the community

### 6.1 Information and hygiene advice

In villages, information about cholera and hygiene measures aimed at the whole population is sometimes provided by international organisations such as WHO and UNICEF, or by the Ministry of Health, who use both traditional and modern communication channels, especially the media.

Local and international NGOs, possibly with assistance, form excellent information relays in urban neighbourhoods and in villages for spreading information and advice about cholera.

In a rural environment, and in the absence of NGO partners, the intervening NGO has to develop hygiene messages and spread them via civil and/or religious authorities.

Teams composed of one hygiene educator and one or two sprayers try to limit the primary infection centres by disinfecting soiled places in the homes of patients (floors, beds etc.). These teams are also in charge of providing hygiene information to patients' contacts. The teams are connected to the CTC, where they gather information and select the sites to be treated (6 to 8 sites/team/day). Depending on population density, these teams are either on foot in the case of small area centres, motorised in the case of centres in rural areas or a mixture of the two, usually in urban areas, with the vehicle being used for the transport to the working area, supervision, and possibly transfer of a mobile team to dispersed sites beyond walking distance.

The hygienist must address messages to the relatives and neighbours of patients, to inform them, explain the sprayers' work and detect more suspected cases.

The messages describe the symptoms of the disease, where to go for treatment, and prevention methods: food preparation, hand-washing, choice of water source, treatment of drinking water etc.

The sprayers use two types of solution: solution B for clothes, dishes, beds and houses, and solution A for latrines and defecation fields. Disinfection by spraying must normally be carried out for three successive days. This is not always possible over the whole area, so there is a need to prioritise areas at risk, and in those areas to identify centres of infection by studying the origin of cases.

### 6.2 Improving water quality

The following actions, listed in order of priority, must be planned:

- use the existing supply (wells, distribution systems, boreholes etc.) if water quality can be guaranteed by effective actions such as disinfection;
- provide an alternative supply, usually by water trucking to distribution points and/or a mini-supply system on a borehole or a mini treatment station;
- improve the quality of water for consumption by distribution of chlorine to households, and jerrycan-disinfection points.

Some standard actions are given below.

## 6.2.1 CHLORINATION OF WATER POINTS

- Disinfection must be verified by measuring free residual chlorine. Depending on the context, it can be:
- chlorination of the mains water, and verification of the amount of free residual chlorine at the water points;
  - daily chlorination of wells carried out by local teams;
  - chlorination of other sources of water supply.

### 6.2.1.1 *Municipal water-distribution system*

Theoretically, the system should deliver water containing a level of free residual chlorine of between 0.3 and 0.5 mg/l at the tap. In times of cholera, it is absolutely essential to increase this level: a level of free residual chlorine of 0.8 to 1 mg/l must be measurable at the tap.

In 1991, in Peru, a problem with the chlorination system, together with pollution of seafood, were the origin of a high attack rate in coastal regions (1.5%).

Some support can be given to treatment stations:

- technical: daily monitoring of chlorine level at water points;
- logistics: supply of chlorine and other consumables;
- emergency: rehabilitation of water points.

Finally, it is necessary to ensure that the population is well informed (press, radio, authorities), so that people go only to chlorinated water points.

### 6.2.1.2 *Shallow boreholes and wells*

The sanitary conditions of these water points depend on the quality of their construction, protection measures (cover, handpump etc.), and the sanitary conditions of the surroundings (see Chapters 7 and 8). They are an important source of supply, and therefore must not be neglected. The actions to carry out are:

- chlorination (Box 14.2) and monitoring of the amount of free residual chlorine (once or twice daily);
- cleaning and disinfection when pollution is evident (Box 14.3);
- emergency rehabilitation (surface works, waterproofing);
- closure if any of the above actions cannot be efficiently implemented and if the population has an adequate alternative water supply.

## 6.2.2 DISTRIBUTION OF DISINFECTANT TO HOUSEHOLDS

Water can become contaminated between the distribution and consumption points: dirty recipients and plugs, wooden ‘wavebreakers’ in buckets, open storage vessels, water taken from storage vessels by dipping in contaminated cups etc. This kind of water is an excellent culture medium for the cholera vibrio if it does not contain enough free residual chlorine. The chlorination of water points must therefore maintain a level of free residual chlorine of 1 mg/l in order to provide the water with sufficient self-disinfecting capacity. If this is not possible, it is advisable to carry out domestic chlorination. This approach is logistically quite difficult: each family is given enough 1% stock solution to disinfect their drinking water for a week (the solution only remains active for this period of time), and then must be given a new supply.

Another approach (more expensive but easier to implement logistically) is the distribution of NaDCC (sodium dichloro-isocyanurate) tablets: one 167-mg tablet treats 20 to 25 l of water.

In Mozambique, ACF developed a similar action by establishing chlorine solution distribution points in the village. This programme was implemented with Culima, a local organisation that already had a very good knowledge of the area.

## Box 14.2 Chlorination.

In recent years, ACF has attempted to develop a continuous chlorination system in order to get an appropriate amount of free residual chlorine in wells or tanks, as an alternative to “one shot” chlorination. Major issues are:

- controlled diffusion and acceptable levels of residual free chlorine (WHO recommendations);
- involvement of the local population and acceptance;
- easy implementation and low cost;
- low maintenance and infrequent need to reload the chlorination system.

### 1) *Periodic method*

This is the traditional chlorination method and was used for a long time in Mogadishu. The stock solution concentration is 1% of chlorine. The stock solution concentration to apply is chosen according to the average water quality in Mogadishu. (Figure 14.8.a: results from 173 wells in 1998. Analysis method: DPD1 and colorimetric chart.)

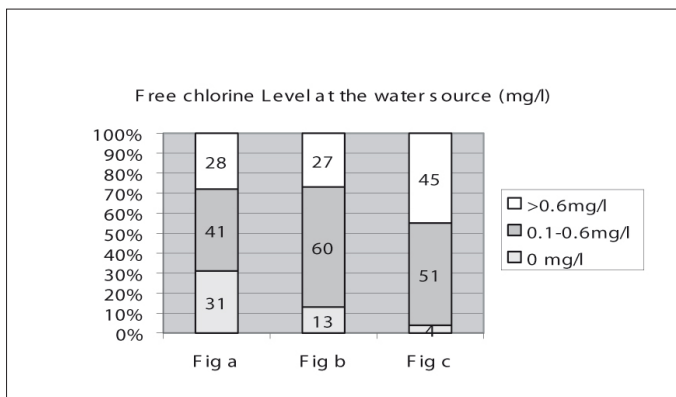
### 2) *Pierced recycled jerrycan*

From October to December 1998, ACF tested a chlorination procedure that uses local materials and provides continuous slowly-diffused chlorine for a period of 12-15 days. Pierced recycled 5-litre oil jerrycans were used, with successive layers of gravel, sand, sand/chlorine mix, sand, and then gravel again. In January 1999 this system was implemented in all wells that ACF chlorinated in Mogadishu. (Figure 14.9.b: results from 919 wells. Analysis method: DPD1 and colorimetric chart.)

### 3) *Immersion of chlorine tablets*

Since the 2000 cholera outbreak, ACF has used a continuous chlorination technique adapted from swimming pool chlorination. Chlorine tablets (125 grams of HTH 75% chlorine) are made locally with a manual press. These slow-dissolving tablets are then inserted in pierced pipes. The pipes are immersed in the wells, tied to the surface with a rope. The chlorination teams visit the wells at least twice a week to ascertain the chlorine level and replace tablets. Each well has its own protocol, depending on its volume and yield, that is established empirically by the chlorinators. They also inform the population about the technique, as well as appointing a well caretaker from the community. (Figure 14.9.c: results from 98 wells in January 2000. Analysis method: DPD1 and colorimetric chart.)

As can be seen from Figure 14.9, only 4% of the wells disinfected with chlorine tablets tested in 2000 had no residual chlorine (Figure 14.9.c). This is an improvement of 27% over the situation two years before, when 31% of the wells showed no trace of chlorine (Figure 14.9.a). This can be directly attributed to the improved chlorination system that provides a simple slowly-diffused continuous source of chlorine, replacing the old system, of someone dumping a quantity of chlorine into the well once a day, that only provided chlorinated water for roughly a one hour period.



**Figure 14.9: Comparative performance of different well-chlorination techniques.**

#### Box 14.3

##### Disinfection/closure of wells.

Wells are disinfected when it is suspected that they are contaminated, either because of one-off contamination (dead body of an animal or waste), or because a detailed study of the CTC files indicates a number of sick people whose families draw their water from the same well.

When there is no possibility of preventing pollution of a water point (see Chapter 8), its closure is considered (with the intervention of the local authorities), while proposing another supply source to its users (for example, another well that will be properly protected). It is always better to look for agreement than to impose a decision that may be easily ignored.

### 6.3 Examples of specific actions

The community must perceive these actions as appropriate, or they risk being inefficient or rejected. Therefore, only general advice can be given; this must be adapted or improved with local conditions in mind, while attempting to ensure the participation of the authorities (religious, secular, modern and traditional) in the preparation and implementation of specific measures.

The beginning of the process requires holding a cholera information session with the authorities to underline possible actions to be taken in the community, while looking for people with positions of responsibility and trying to assess their possible roles.

#### 6.3.1 CLOSED RISK AREAS: CAMPS

Using home visitors, hygienists cover the camp to convey information and recommendations about cholera, reinforce basic hygiene measures (hand-washing), detect suspect cases of diarrhoea, and inform the treatment centre immediately. Frequently, a hygiene education programme already exists, so it is only necessary to provide the hygienists/home visitors with some complementary training about cholera.

Ideally, disinfection of the surroundings of sick people should be immediate: sprayers must be ready to act under the supervision of hygienists.

At public assembly points (high risk areas), such as markets, schools, places of worship and food-distribution points, the messages must focus on hygiene information, and on the recommendations in case of suspected diarrhoea: disinfection of public latrines (slab, walls, door, handle, fittings etc.) and defecation fields with solution A, and finally, waste collection and the disinfection of the area at the end of the day.

#### 6.3.2 OPEN RISK AREAS: LARGE TOWNS AND EXTENDED RURAL AREAS

Ideally, all the actions described above should be carried out, but this is rarely possible in large towns or extended rural areas. Therefore the focus is on sites at clear risk and for which effective action can be guaranteed. These sites often include markets, schools and orphanages.

It is also difficult to intervene in disadvantaged urban areas, that is to say in highly-populated areas with old or faulty sanitary infrastructure and polluted water points. With inadequate sanitation and water supplies, and without specific measures similar to those implemented in camps, these areas are badly affected during cholera outbreaks. Nevertheless, to achieve a certain impact, those sites at highest risk will have to be selected, and sometimes in this context, education and domestic chlorination will be the only effective measures.

## 7 End of the intervention

It is usually easier to start an intervention than to finish it. Management of CTCs or support for local centres can sometimes be on a scale similar to the management of a business, with hundreds of employees or food-for-work volunteers who must be managed as in any normal firm. This managerial role is a position which must be continued until the end of the intervention. When a regular decrease in the number of cases occurs, this large human and financial investment becomes no longer justifiable: this is the time to disengage, but also to evaluate the operation.

### 7.1 Disengagement

#### 7.1.1 TREATMENT CENTRE MANAGED OR SUPPORTED BY AN NGO

The larger the CTC and the involvement of the NGO, the more delicate disengagement is. Nevertheless, centres cannot continue to be managed or supervised by ACF until there are no more admissions.

There are no universal disengagement criteria: in Somalia, the threshold used by ACF is 21 cases per treatment centre per week over 3 consecutive weeks.

If the local partner cannot take charge of a CTC that is no longer suitable for the decreased seriousness of the epidemic, the centre can be closed, and all responsibility devolved to a small specialised structure, perhaps within a dispensary or hospital. Small urban centres usually close progressively when a referral centre for the whole town has been set up. On the other hand, centres in a rural environment remain open for longer, because the transport of patients to a referral centre is usually difficult.

If the CTC is transferred to a partner, the ideal is to know that partner from the start of the operations in order to involve them as much as possible in the management of the centre. Some potential partners are the Ministry of Health, a group of doctors trying to create a local structure, or an NGO (local or international) with a programme and medical structures.

Whatever form it takes, disengagement must be complete:

- fix the conditions of the handover clearly and precisely;
- provide a final delivery of supplies (enough for about one month);
- pay the salaries or food-for-work plus bonuses;
- space supervision out progressively, and then stop it completely.

#### 7.1.2 VERIFICATION AND IMPROVEMENT OF WATER QUALITY

Chlorination of wells is only carried out during the epidemic. It is therefore necessary to keep it up when there are risks, but not once they have disappeared. Sometimes chlorination may be extended up to a month after the last cholera case, but in practice this time limit is difficult to determine, bearing in mind the proliferation of non cholera-related diarrhoea at the end of the epidemic, which may nevertheless be classed as cholera. In the long term, only the rehabilitation of wells, and surface protection works can decrease or eliminate their contamination. This rehabilitation must be complemented with educational actions if the water is to remain potable.

Even though the reappearance of cholera may be dramatic, it is only episodic, whereas other diarrhoeal diseases remain prevalent, and are an important cause of child mortality. Water-quality monitoring must therefore continue: it must target certain water points that have problems and/or are highly frequented, and should be geographically spread over the whole area. Water quality is determined by regular bacteriological analysis (see Chapter 4).

#### 7.1.3 SELECTIVE TRAINING/DISINFECTION TEAMS

Closure of the centres means the deactivation of the teams that have been created. Nevertheless, some may continue to work under the control of the remaining referral centres, which maintain some logistics capacity for work in their area.

It is also advisable to maintain this activity on a smaller scale to collect field data with which to monitor the development of the epidemic, together with data from treatment centres that are still working. Some outbreaks can still appear in certain areas in case of endemic cholera, and the disinfection teams are then able to detect them and act accordingly. These actions, which are not very expensive, also allow indirect monitoring of the quality of the water points.

At the end of the epidemic, the cholera monitoring system is included in the national surveillance system.

## 7.2 Evaluation

Analysis of the epidemic based on epidemiological data enables the efficiency of the intervention, and in particular that of ACF, to be evaluated and compared to the initial objectives. (Has the defined intervention strategy met the needs?)

The key points to be examined are the speed of implementation and supply, the quality of staff training, and the effectiveness of the coordination between the various intervening organisations and individuals.

### 7.2.1 INITIAL ASSUMPTIONS

Were the initial assumptions confirmed (attack rate, affected areas, rate of expansion etc.)? If not, why not?

Was the development of the epidemic anticipated, or did it exceed all expectations? Was reliable information lacking? Was the analysis insufficient? Did unforeseeable events take place?

### 7.2.2 EPIDEMIOLOGICAL DATA

When the epidemic is considered to be over, some definite figures are established:

- total number of cases, overall attack rate, and distribution over time;
- geographical distribution of the cases, and attack rate (per neighbourhood or village);
- distribution per age group and sex of declared cases and deaths;
- number of secondary cases (including family), ratio of secondary cases to total cases (and development);
- number of deaths, and case-fatality rate (number of deaths per number of cases) as a whole, and per treatment centre;
- seriousness of the cases at admission (grade of dehydration on admission);
- treatment provided (what treatment and under what form, oral or intravenous).

The attack rate is carefully analysed, because it reflects the characteristics of the environment, the population's hygiene habits, and the ability of the responding organisations to achieve the (provisional!) improvement of sanitary conditions using hygiene promotion, disinfection, rigorous management of the CTCs (isolation), and water supply. The number of secondary cases is also a good indicator of conditions and hygiene habits. The development of the ratio of secondary cases to total cases should be compared with the activities of the disinfection and water-supply chlorination teams.

The geographical distribution of the attack rate is an important factor: geographical differences can be interpreted as environmental differences (water supply/sanitation/housing), or as differences in the effectiveness of intervention. In similar environments, what are the actions (or their mode of application) that have caused those differences? In any case, a relatively low attack rate can sometimes be explained by patients being treated at home for reasons of distance or insecurity, or because information has not been effective.

Lastly, the case-fatality rate is an important indicator. According to WHO, when it is less than 1%, it indicates good control of the epidemic by the medical and sanitary intervention (rapid case detection and management in particular). This figure is significant only in relation to a given envi-

ronment: in practice, the medical personnel on the ground have a better knowledge of the significance of the 'control' of the epidemic (what was avoidable and what was not). In some situations, given all the constraints faced, a 10% case-fatality rate can be considered a positive result (without treatment it can reach up to 50%).

The high number of barely quantifiable factors which can cause contamination makes it rather difficult to interpret epidemiological figures. The main thing is to evaluate trends and to establish comparisons. In any case, there is always some uncertainty about the validity of the records kept.

### 7.2.3 COSTS

Three balance sheets are drawn up for the intervention:

- total cost: medical and sanitation products, rehabilitation material, water-supply and other equipment, logistics, salaries;
- cost per patient treated;
- cost per product consumed (HTH, ORS, Ringer's lactate, antibiotics etc.).

## 7.3 After the cholera response

A cholera intervention consumes a lot of energy, sometimes to the detriment of an NGO's ongoing programmes, but it also allow it to do the following positive things:

- identify new areas at risk in terms of water and sanitation;
- work with local NGOs, and evaluate their efficiency;
- create a certain dynamic around sanitation in the community and among decision-makers;
- reinforce the links between the international intervening parties and the national technical authorities who coordinate their actions;
- measure (and justify, retrospectively) the impact of ongoing programmes in terms of prevention, with the analysis of CTC statistics.

Therefore, the intervention also improves knowledge of the geographical area covered, which can be the beginning of a possible reorientation of activities.





V

Hygiene promotion  
and community management



# Hygiene promotion

<b>1</b>	<b>Introduction</b>	541	<i>2.3.9 Seasonal calendars</i>	558
1.1	What is hygiene promotion	541	<i>2.3.10 Gender roles/tasks analysis</i>	558
1.2	Why is hygiene promotion important?	541	<i>2.3.11 Water analysis</i>	559
1.3	The hygiene-promotion project cycle	544	<b>2.4</b>	<b>Recruitment and training</b>
<b>2</b>	<b>Needs assessment</b>	544		of the assessment team
2.1	Preliminary appraisal	544	<i>2.4.1</i>	<i>Choosing the assessment team</i>
<i>2.1.1</i>	<i>Detecting a problem</i>	545	<i>2.4.2</i>	<i>Training the assessment team</i>
<i>2.1.2</i>	<i>Defining the target area</i>	545	<b>2.5</b>	<b>Analysis of results</b>
<i>2.1.3</i>	<i>Appraisal techniques</i>	545	<b>3</b>	<b>Programme planning and design</b>
<i>2.1.4</i>	<i>Planning the in-depth assessment</i>	545	3.1	Setting programme goals
2.2	In-depth assessment	545	3.2	Selection of target practices
<i>2.2.1</i>	<i>What to look for</i>	546	3.3	Selecting the target audience
	2.2.1.1 Identifying risk practices	546	3.4	Designing the message
	2.2.1.2 Defining target audiences	547	3.5	Communication channels
	2.2.1.3 Defining the communication channels	547	<i>3.5.1</i>	<i>Pictures</i>
	2.2.1.4 Planning the in-depth assessment	547	<i>3.5.2</i>	<i>Theatre/puppets</i>
2.3	Research techniques	549	<i>3.5.3</i>	<i>Storytelling</i>
<i>2.3.1</i>	<i>Health-walk</i>	549	<i>3.5.4</i>	<i>Songs</i>
<i>2.3.2</i>	<i>Structured observations</i>	549	<i>3.5.5</i>	<i>Video, slides etc.</i>
<i>2.3.3</i>	<i>Key-informant interviewing</i>	550	<i>3.5.6</i>	<i>Mass media</i>
<i>2.3.4</i>	<i>KAP survey</i>	550	3.6	Selection of the communicators
	2.3.4.1 Types of KAP survey	550	<i>3.6.1</i>	<i>Teachers as hygiene communicators</i>
	2.3.4.2 Sample calculation	551	<i>3.6.2</i>	<i>Community hygiene facilitators</i>
	2.3.4.3 Examples	551	3.7	Consolidation
<i>2.3.5</i>	<i>Focus-group discussion</i>	553		of the communication plan
<i>2.3.6</i>	<i>Three-pile sorting</i>	557	3.8	Distribution of hygiene kits
<i>2.3.7</i>	<i>History line</i>	557	<b>4</b>	<b>Monitoring and evaluation</b>
<i>2.3.8</i>	<i>Community mapping</i>	558	4.1	Monitoring
			4.2	Evaluation
			<b>5</b>	<b>Example: Laos</b>
				572

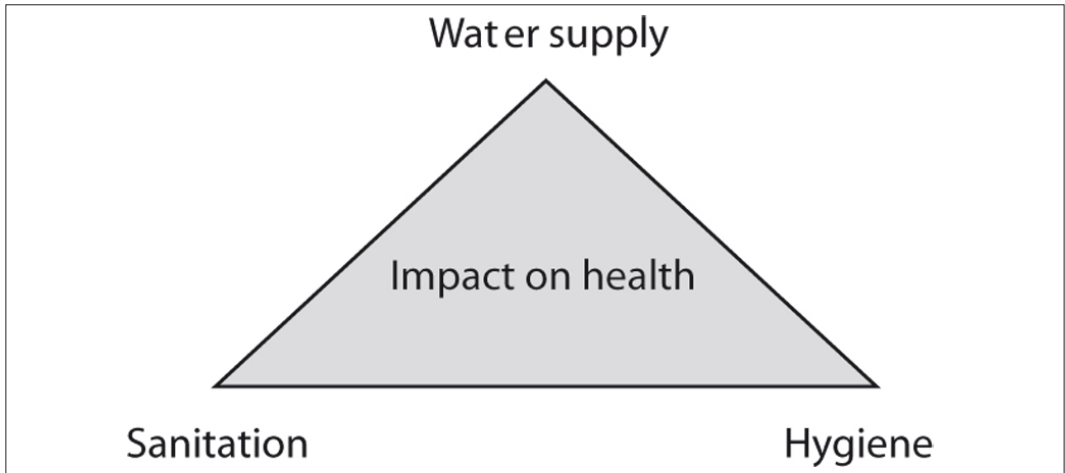
## 1 Introduction

### 1.1 What is hygiene promotion?

Hygiene promotion includes all the activities aimed at increasing people's health status through the improvement of the hygienic practices in their day-to-day life.

### 1.2 Why is hygiene promotion important?

Health is one of the main concerns of humanitarian programmes and is a full component of the fight against vulnerability and malnutrition. Emergencies can cause an increase of water- and sanitation-related diseases and in some cases can cause epidemic outbreaks, putting many people's lives in danger.



**Figure 15.1: The three main components of public health engineering.**

Improvement of health can be achieved by focusing on three fundamental areas: the health-care system, water and sanitation infrastructure and the population's health-related behaviour. Figure 15.1 shows the three main components of public health engineering.

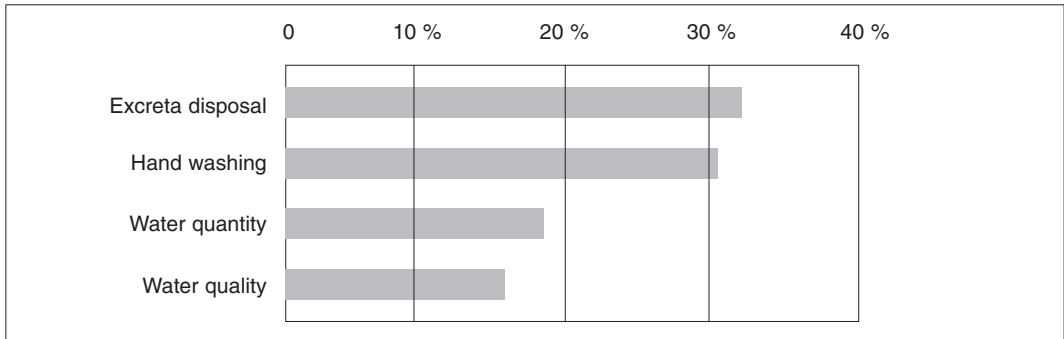
Water- and sanitation-related diseases are the main health problem within developing countries and therefore the main cause of mortality. Their development and transmission depend directly on access to facilities, vector-control measures and water-handling and hygiene habits. Clean water and sanitary facilities are essential for improving the sanitary environment, but poor results will be achieved in terms of public health if hygiene practices are not appropriate: the clean water provided by a protected source can be contaminated if it is not correctly handled; the impact of a latrine will be reduced if people don't use it properly and don't wash their hands after using it; and the stagnant water accumulated around a badly-maintained water point can be a serious sanitary risk for its users and nearby inhabitants.

Hygiene promotion has a proven impact on the reduction of diarrhoeal diseases (Figure 15.2). Hand-washing is reported to be almost twice as effective as improvements in water quality alone: a safe water point will have little impact on health if water is not correctly handled. Figure 15.2 shows the influence of different programmes on the reduction of diarrhoeal diseases, but special attention has to be paid in interpreting these figures, considering for example that the availability of safe water is a component of hand-washing.

The objective of many programmes is to reduce the risk of spreading water- and sanitation-related diseases, through an integrated approach where water, sanitation and hygiene promotion are closely connected.

Hygiene promotion focuses on reducing the main risks related to health and the use of water-supply and sanitation facilities through an improvement in people's knowledge and behaviour. The more frequent topics developed in Hygiene Promotion programmes are:

- transmission of diseases, understanding of risks and solutions;
- proper use of facilities;
- proper water use: collection, transport, storage and consumption;
- promotion of appropriate sanitation;
- basic personal hygiene;
- environmental hygiene;
- food hygiene;
- child hygiene.



**Figure 15.2 : Estimated impact of different activities in the reduction of diarrhoeal diseases (Esrey et al. 1991).**

Hygiene depends on people’s habits, and these habits depend mainly on 5 factors:

- *Beliefs and taboos*: some beliefs can be connected to health risks. Water has a holistic value for many communities and it is very important to understand and to respect it. Programmes must be adapted to the specificity and culture of communities.

- *Knowledge*: many communities are not aware of the relation between the environment and diseases, nor are they aware of paths of transmission and the measures to avoid them. Understandable information is needed.

- *Behaviour and existing habits*: some existing habits have a negative impact on health and they are difficult to change, especially if they are connected to beliefs. Sometimes inappropriate habits are due to lack of knowledge, but often they are a question of will. Hand-washing is an example: people often know that it is necessary to do it before eating, but may not do it.

- *Perception of risk*: during a disease outbreak people are more sensitive to the importance of hygiene, and protective habits are easier to introduce. In normal situations, even if lack of hygiene has a big impact on health, people are used to this situation and behaviour is more difficult to modify.

**Table 15.I: Hygiene promotion in the short term and longer term.**

	Acute risk	Chronic risk
Beliefs	Short time to understand, easy to make mistakes	Indispensable to take time to understand
Knowledge	Importance of spreading messages Habits need changing even if the communities do not have the knowledge: focus on marketing	Improvement of knowledge is indispensable for a change in behaviour: focus on education
Existing habits	Changes will not be long-term, but it is important to aim to change habits at least for this period of time	It is important to analyse existing habits before changing behaviour
Perception of the risk	Easier to react if there is a major risk due to a sudden change – people will be more proactive	It is more difficult for the communities to perceive risk as they are used to the situation
Facilities	Emergency response: quick and effective solution Construction and rehabilitation is normally a priority in emergency programmes	Facilities must be appropriate to being managed and maintained by the communities, who must participate from the beginning of the project

– *Availability of facilities*: clean water and sanitation facilities are necessary in order to facilitate and support basic hygiene habits, and allow their adoption.

The shape of a hygiene-promotion programme will depend basically on the identification of the main health risks (magnitude and duration) and on the availability of time to develop the intervention. During major crises when an emergency response is needed, hygiene promotion must be a priority, but seeking permanent changes in people’s behaviour is not realistic in this kind of intervention. Very often, risk continues after the emergency period, and the hygiene promotion programme must be adapted through a long-term approach. See Table 15.I.

### 1.3 The hygiene-promotion project cycle

This chapter explains the main steps, methodologies and tools used for hygiene promotion, following the project cycle, from the identification of needs to the evaluation of a programme. Table 15.II shows the different steps in the project cycle of hygiene promotion.

**Table 15.II: The project cycle of hygiene promotion.**

Cycle	Phases	Outputs
	Preliminary appraisal	Estimation of water & hygiene-related disease incidence Analysis of the social and physical context
	Detailed assessment	Identification of risk practices
	Planning	Selection of target risk practices to modify Selection of target audience Definition of the message Selection of communication channels
	Transmission of the message (Implementation)	The message must be 1) noticed 2) understood 3) accepted 4) acted on (risk practices are changed)
	Monitoring	The question <i>How is it working?</i> is answered
	Evaluation	The question <i>Has it worked?</i> is answered

## 2 Needs assessment

Every project starts with an assessment. Assessments are where qualitative and quantitative information is collected and analysed. On the basis of this analysis, the programme objectives are set and activities are planned.

Assessing people’s behaviour is complicated. A specific practice that involves a sanitary risk can have its origin in a fact that we cannot explain at first glance. Before proposing a new practice to replace a risky one, we have to be sure that it doesn’t represent a problem for the people concerned in terms of culture, economy, tradition, taboos etc. That is why the assessment requires enough time and means.

The assessment section is divided into three stages: Preliminary Appraisal, Detailed Assessment (specific information) and Analysis of Results.

### 2.1 Preliminary Appraisal

Before assessing specific issues about hygiene practices, it is important to know who are the target population. The preliminary appraisal is the process of detecting the problem and collecting

contextual information that will help carry out a deeper assessment. This part of the assessment has to be adapted to the context and nature of the population concerned.

### 2.1.1 DETECTING A PROBLEM

The assessment should respond to a previously-detected health problem. As every hygiene promotion activity aims to reduce the incidence of water- and hygiene-related diseases through the reduction of certain risk practices, the first information to look for is the incidence of this kind of disease, to decide whether an intervention is necessary or not. Once this has been established, it should be estimated to what extent the health problem is caused by human behaviour (see Chapter 2).

This preliminary medical and epidemiological information can be found in health institutions (hospitals, health centres, health ministry etc.) or elsewhere (other agencies working on health, local authorities, traditional healers etc.).

### 2.1.2 DEFINING THE TARGET AREA

The next step is to define the physical area and the population where the problem exists, and where hygiene behaviours should be assessed.

The information that is needed for designing a hygiene education and promotion programme is mainly related to social issues. Before doing in-depth research, some general information concerning the people living in the area that is going to be assessed is needed: languages spoken, ethnic groups, religion, politics, taboos, previous contacts, coping mechanisms, markets, gender information, traditional authorities etc. It is useful to have information that is gender-specific (i.e. what is related to men, what to women and what to both).

This information provides a baseline that will be built on afterwards with in-depth assessment and programme monitoring.

### 2.1.3 APPRAISAL TECHNIQUES

Information can be gathered for the appraisal as follows:

- Prior to presence in the field: information coming from the internet, media, other organisations working in the same area etc.
- In the field: using some of the techniques used in the in-depth assessment, such as key informant interviews and health-walks (see Section 2.3).

### 2.1.4 PLANNING THE IN-DEPTH ASSESSMENT

The last step to be carried out in the preliminary appraisal is the planning of the in-depth assessment to be done prior to implementation. This planning includes the timing, the budget and the recruitment of the assessment team. The budget and time required for doing a good assessment is higher, and the time needed to assess cultural and social issues is much longer, for this kind of programme than for a construction programme.

## 2.2 In-depth assessment

The in-depth assessment is the part of the assessment that investigates hygiene practices, using a variety of techniques, such as focus group discussions and other participatory tools that can be used over long periods, or directive surveys such as KPA surveys that are more one-off studies. The in-depth assessment gives an idea of the key risk hygiene practices in a target area. Additionally, it could highlight the need for better infrastructure or suggest modifications to an existing programme; in any case, this study should identify interim solutions that allow better hygiene in the absence of improved infrastructure.

## 2.2.1 WHAT TO LOOK FOR

The main questions that should be addressed during the in-depth assessment are:

- What are the main diseases affecting the population? What is the incidence of diarrhoeal diseases?
- What are the practices that involve a high risk?
- Among these practices, which are the most common and easiest to replace by new ones (safe practices)?
- What are the perceived advantages of those safe practices to the community?
- Who carries out the risk practices and who influences them?
- What communication channels would be trusted for hygiene-promotion messages?

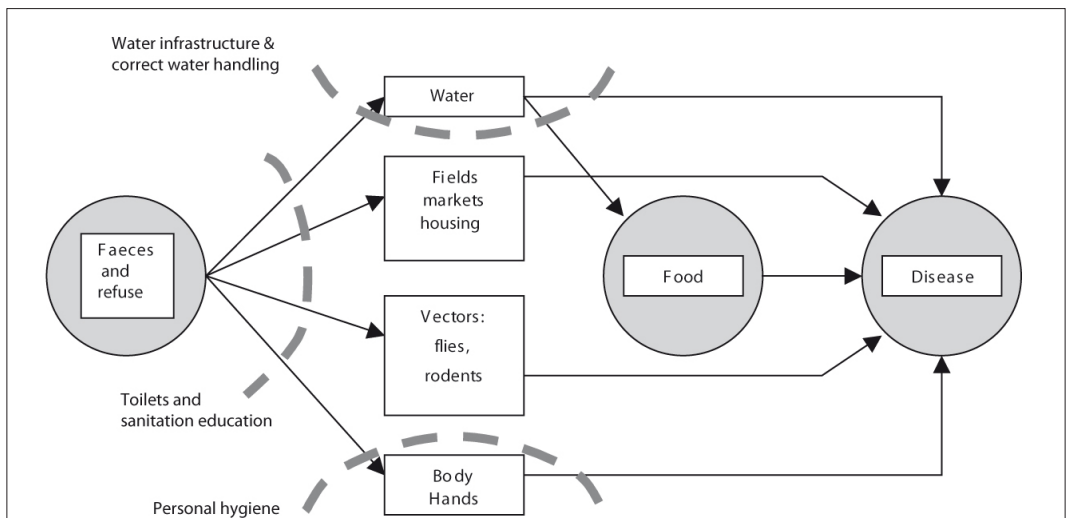
### 2.2.1.1 Identifying risk practices

To decide what kind of programme is suitable for solving the problem, the disease-transmission routes that represent the main sanitary risks should be identified. For example, if the problem is that there are no sanitation facilities and there are stools in the surroundings of the houses, the construction of latrines can be a part of the solution. If the water point provides potable water that is then contaminated in the home then correct water-handling practices should be promoted.

As an example, Figure 15.3 shows the various routes for the transmission of faecal-oral infections and where action can be taken to break transmission.

The main risk practices associated with water and environmental sanitation (including faecal-oral disease transmission shown in Figure 15.3) can be classified as follows:

- Excreta disposal: as faeces are the primary origin of diarrhoeal diseases, the most effective solution is to separate excreta from the places where people live and work. If this is done properly and the contacts between excreta and the human environment are minimised, a big part of the problem will be solved. The lack of toilets doesn't lead systematically to unhealthy excreta management. In some places with a low density of population, there is enough space to bury the excreta in the bush and prevent it from contaminating the human environment.
- Hand-washing: if hands are not correctly washed with water and ashes or soap after contact with faeces, they become an important route for the transmission of disease.



**Figure 15.3: Faecal-oral disease transmission routes (adapted from UNICEF, 2000).**



- Safe water: hygiene is not possible without a sufficient quantity of safe water, but water becomes a dangerous vehicle of contamination if it is not correctly handled. Even if the water is of good quality at the source, only safe behaviour in terms of water collection, transport and storage will allow people to drink it without being exposed to a sanitary risk. If the quality at the water source cannot be guaranteed, boiling or filtering it is a practice that can be used to protect health.
- Vector control: flies are an important vector of transmission of pathogens from faeces to food. The best way to reduce this transmission is to improve excreta disposal with latrines, or other toilets, with a properly-covered pit or a septic tank. Mosquitoes, rodents and fleas are other examples of vectors transmitting different diseases.
- Food hygiene: bacterial pathogens can multiply in food, especially in humid and warm conditions. This is one of the reasons why diarrhoeal peaks occur mainly during the rainy seasons in tropical countries. Poor handling of babies' bottles, keeping food in warm conditions or cooking with dirty hands are examples of risk practices with food that should be avoided.
- Environmental and household hygiene: presence of solid waste, stagnant water, dust etc. create conditions for the proliferation of different vectors. Stagnant water is favourable to mosquitoes, and thus promotes the transmission of malaria.

### *2.2.1.2 Defining target audiences*

Target audiences are the groups of people who should be reached by the hygiene-promotion programme. They can be viewed as three distinct groups: primary, secondary and tertiary target audiences.

Primary target audiences are those who carry out the risk practices (e.g. mothers and children). Secondary target audiences are the immediate contacts of the primary audience, who influence them (e.g. fathers, mothers-in-law or school-mates). The important tertiary target audience is formed principally of opinion leaders (e.g. religious, political and traditional leaders, and elders). Other factors to be considered when targeting groups include:

- Vulnerability: some groups of people are more vulnerable to health risks (children, women etc.).
- Acceptance and impact: children and women normally have more interest in hygiene issues and it is easier to introduce changes in their behaviour than that of men.
- Capacity and resources: introducing changes in behaviour involves working closely with the people concerned. This can require a big effort, which is often not possible for all the population, and in this case the most vulnerable groups should be prioritised.

### *2.2.1.3 Defining the communication channels*

It is important to know what are the communication channels preferred by the target population and which ones can have the greatest impact for promoting the new safe practices. To find out, some questions should be answered:

- What is the most common communication channel among the target population?
- What are the different forms of discussion, meetings, celebrations and religious practices?
- Who listens to the radio and watches TV regularly? Do they read newspapers?
- What proportion of the target population can read?
- Which channels of communication do they trust?
- Are there traditional ways of communicating such as music, theatre, dance etc. that can be used to transmit a message?

### *2.2.1.4 Planning the in-depth assessment*

The research plan is a detailed plan for the in-depth assessment, based on the outline and results of the preliminary appraisal. It includes a list of questions to be answered during the process,

that are formulated specifically to suit the population concerned. The research team that will carry out the assessment needs to be selected.

### Research question list

The list of questions to be answered by the assessment should be prepared. It is best to carry out this process as a team exercise. The list should be limited to those questions that really relate to hygiene promotion; otherwise, it will be difficult to manage information gathering. Once the list of questions is prepared, the appropriate methods to answer them should be selected. Table 15.III shows a typical list of questions.

**Table 15.III: Example of question list for a detailed hygiene-promotion assessment.**

Issue	Practices <i>What people do</i>	Knowledge <i>What people know</i>	Resources <i>What is available</i>
Diseases	Incidence of diarrhoea Main diseases (diarrhoeal diseases, malaria, skin diseases etc.)	What are the causes of the different diseases reported? How to prevent and treat different diseases	Hospitals, health centres etc.
Water	Origin of drinking water Cleanliness of the water point Containers used for collection, transport and storage Cleanliness Do people treat the drinking water? (boiling/filtering, sedimentation etc.) Person-water contact (do people touch the water to be consumed?) Quality of the water (taste, colour, faecal contamination etc.)	Preferred type of water, why? Relation between water and diseases	Water facilities Resources for treating water: wood, whistling kettle, filters Water containers for collection, transport and storage Cleaning products and tools
Food	Food conservation and protection Food washing and handling	Where do people keep their food? Is it protected from heat, flies etc.?	Cool places Cupboards
Excreta disposal	Where do people defecate? Presence of stools in human habitat State and use of latrines Anal cleansing	Relation between faeces and diseases Advantages of using latrines	Latrines/ toilets Availability of cleaning tools
Environmental hygiene and sanitation	Cleanliness of environment, presence of refuse Stagnant water, disposal of wastewater Where do people dispose of their rubbish? (incineration, burying, nothing)	Diseases caused directly or indirectly by stagnant water Risks from the presence of rubbish	Drainage and sewerage systems Refuse disposal system Availability of cleaning tools
Personal hygiene	Do people wash their hands – before eating? – after defecating? – before cooking? – after washing a child? What do they use for washing hands? (soap, ashes, water alone) How often do people have a bath / shower? Where do people hang out their clothes?	Advantages of washing hands and general personal hygiene	Soap Clean water Facilities: showers, laundries, clotheslines Nail clippers
Vector control	Presence of flies, fleas, mosquitoes, rodents etc. in the human environment	Danger created by different vectors	Mosquito nets Poison or traps for rodents

## 2.3 Research techniques

It is not enough to describe existing hygiene practices, such as methods of excreta disposal or refuse disposal, without finding out what physical, social, cultural or economic constraints might be operating locally to cause people to do what they do. People in the study population should be involved in the investigation, analysis and interpretation of their own situation. This is important, because they will then have an interest in, and a sense of ownership of, the information gathered, and they will perhaps have an interest in making use of the assessment findings if they are presented in accessible forms.

One of the first things that has to be done when carrying out a survey is to define the scale of the investigation. This depends on the size of the target area; the larger and more varied it is, the larger the study needed. One rule of thumb is to carry on with the investigation until no longer learning anything new.

Another factor in the choice of sample size is the scale of the proposed programme. There would be little point in spending so much time and using up so many resources in the research that nothing is left for the intervention. But skimming on an in-depth assessment could lead to costly mistakes, wasted effort and demoralisation for all concerned.

Below follows a list of methods and techniques that can be used to carry out the in-depth assessment. It is not necessary to use all the methods, however. The techniques chosen will depend on the capacity of the study team to use them. The methods proposed in this chapter are complementary, and the use of several of them should enable crosschecking of the information obtained.

### 2.3.1 HEALTH-WALK

The aim of this method is to form a rapid understanding of the environment in which hygiene behaviours take place. This method is in fact a structured a visit to a settlement without carrying out formal research. It takes between 1 and 3 hours, during which two or three field workers will walk around the settlement. They will observe the different hygiene practices and interactions between people and discuss with some of those met during the walk.

It is better to conduct the health-walk at the hours when most of the hygiene practices occur (first and last hours of the day). The health-walk takes in the main places where important hygiene practices take place, such as water points, latrines, washing areas, markets, surroundings of the households, places where children play and public places.

During the visit a team member takes notes and the team holds a discussion afterwards

It is a method that allows us staff quickly to understand the people and their environment, but the information collected should be treated with caution, as it is often the fruit of a first impression that can be shallow or even wrong.

In order to improve the effectiveness of a health-walk, it is a good idea to decide on the main places to visit and to organise structured observations of hygiene facilities and behaviours there.

### 2.3.2 STRUCTURED OBSERVATIONS

This method is appropriate when the objectives of the research are clear and specific, and when there is limited time for the study. The observations, which must be conducted after defining a list of elements to observe, can be carried out during health-walks and interviews.

The focus of the observation can include the following:

- *Water points*: location and state of the water supply facilities, hygiene practices around them:
  - cleanliness of the water point, is it well maintained? is there proper drainage of the water? access of animals to the water point, presence of rubbish or stools in the surroundings;
  - water collection: system used (pump, rope & bucket, person-water point contact, is the same bucket used for everybody, or does each person bring their own bucket? do people clean the container before filling it?), cleanliness of collection system;

- water handling: person-water contact during the process of collection/ transport/ storage;
  - water transport: container used and its state of cleanliness.
- *Sanitation facilities*: where do the people defecate? state of latrines (if they exist), are they used? availability of water close to the latrine.
- *People*: appearance, apparent state of cleanliness of hands, bodies and clothes, is it possible to perceive any skin disease? physical contacts between people.
- *Community environment and public places*: general cleanliness, presence of stools near the households, stagnant water, rubbish disposal, existence of flies and mosquitoes, presence of animals, animal-person contacts etc.
- *Household*: level of cleanliness, available space per person, container used for storing water, is it the same as for transport? is it covered? can/do people put their hands in the stored water? places where food is stored, are they cool, are they protected from flies and rodents? aeration, smell, humidity in houses, existence of mosquito nets.

The list should be memorised to ensure that the observation passes as unnoticed as possible and the risks of influencing people's behaviour are minimised.

The observer takes notes that will be discussed with the other members of the team and the information obtained must be cross-checked with that from other sources.

If the observer is rigorous and skilled enough, the data collected using this method is more objective and reliable than secondary information coming from other people's reports.

### 2.3.3 KEY-INFORMANT INTERVIEWING

This method is appropriate for obtaining specific information on hygiene issues. It involves interviewing people who are assumed to be knowledgeable about problems related to health, hygiene, sanitation and water. Typical key informants for these issues can be:

- health workers;
- staff of other agencies working in the area;
- traditional authorities and older members of the community;
- staff of the ministries related to health and water.

In the interview, the interviewer raises the point of interest and then lets the interviewee lead the discussion. If the person is really knowledgeable about the issue, she/he will become a key informant.

This is a good method to research issues related to hygiene practices or the specifics of the context, but researchers should be aware of possible bias that can influence the results of the assessment, particularly if the key informants interviewed are limited in number.

### 2.3.4 KAP SURVEY

The KAP (Knowledge, Attitude and Practice) survey is a method that allows an assessment of needs and an evaluation of the impact of a hygiene-promotion programme. This method is carried out through structured interviews, which allows quantitative results to be obtained which can then be statistically analysed.

#### 2.3.4.1 Types of KAP survey

##### *Exhaustive survey*

This survey covers the whole population. It is the most accurate (100% of people interviewed), but it is difficult to carry out if the population is large (> 500).

##### *Surveys by sampling*

These surveys are carried out on a representative sample of the population.

In simple random sampling, each family interviewed is chosen arbitrarily using a table of random numbers. This requires a list of the families and a plan of the settlement where these families live.

In systematic sampling, the first family to be interviewed is chosen at random using a table of random numbers; the following families are designated using a sampling step which is added to the previous number until the desired sample size is obtained.

The sampling step  $P$  depends on the size of the sample:

$$P = \frac{n}{N}$$

where  $n$  is the number of families in the target population, and  $N$  the sample size. Systematic sampling also needs a list of the families and a plan of the settlement.

In cluster sampling, which is suitable for large populations (> 5 000), a list of villages in the area, or sections of a settlement, and their population is needed. The principle consists of determining the number of families that constitute a cluster by following a precise method, and then localising the clusters to be sampled. A fixed number of families are interviewed within each cluster.

#### 2.3.4.2 Sample calculation

*General case*

$$N = \frac{t^2 (p \times q)}{d^2}$$

where  $N$  is the sample size;  $t$  is the error risk parameter related to the confidence interval (for ACF surveys, a confidence interval of 5%, which corresponds to  $t = 1.96$ , is assumed);  $p$  is the expected prevalence (for ACF surveys, a value of  $p = 0.5$  is chosen, i.e. 50%);  $q = 1 - p$ , i.e.  $q = 0.5$  for ACF surveys;  $d$  is the degree of accuracy required, generally 5%, i.e. all the indicators studied are within an accuracy range of 5%.

The accuracy level must be chosen depending on the objective: if the aim is to get an idea of population knowledge in order to adjust hygiene-education actions in the field, a 10% accuracy is sufficient. If the aim is to highlight a statistically important change within the population, greater accuracy is essential, but this requires an increase in sample size, and therefore in the time and resources required for the survey. The problem is to find a good compromise between operational feasibility and epidemiological rigour.

*Particular cases*

Cluster surveys can decrease the representativity of the sample. The families within each cluster are neighbours, and can therefore present similarities in the characteristics studied. This is called the cluster effect, and the sample needs to be multiplied by 2 to counteract it.

A correction factor can be applied when the sample size reaches one tenth that of the target population (large sample in relation to the population). In this case:

$$Nr = \frac{N}{1 + (N/n)}$$

where  $Nr$  is the size of the corrected sample,  $N$  the size of the sample calculated using the general formula, and  $n$  the size of the target population (number of families in the target population).

#### 2.3.4.3 Examples

*Village with 80 families*

The number of people is low, the houses are concentrated, and the village plan has been made. In this case, an exhaustive survey can be carried out.

### *Village with 1 000 families*

The number of people is too high for an exhaustive survey. Therefore, a survey of a simple random sample is carried out:

- stage 1: draw up a list of families, number them (from 1 to 1 000), and make a plan of the village;
- stage 2: size of the sample:  $N = 1.96^2 (0.5 \times 0.5)/0.05^2 = 384.16$  (an accuracy of 5%). The size of the sample is large in relation to the number of target families ( $N > n/10$ ); therefore it can be corrected so that  $Nr = 384.16 / [1 + (384.16/1\ 000)] = 277.54$ , rounded to 278;
- stage 3: draw 278 numbers from the table of random numbers, which correspond to families to be interviewed (278 of the 1 000 families will therefore be surveyed).

To draw 278 numbers from the table of random numbers is quite a long process, so systematic random sampling is another possibility:

- stage 1: draw up a list of families, number them (from 1 to 1 000), and make a plan of the village;
- stage 2: size of the sample:  $Nr = 278$ ;
- stage 3: calculate the sampling step:  $P = 1\ 000/278 = 3.60$ , rounded to 3;
- stage 4: draw the sampling interval (a number between 1 and 1 000) at random, from the table of random numbers - for example 25;
- stage 5: determine the number corresponding to the families to be interviewed, as follows:
  - 1st family = number 25;
  - 2nd family = number  $25 + 3 = 28$ ;
  - 3rd family = number  $28 + 3 = 31$  and so on, until 278 families are obtained.

### *Population of 8 000 families*

This population is scattered throughout several sectors of the same town or throughout several villages. In this case the cluster sampling method is the most suitable:

- stage 1: determine the number of target families, in this case 8 000;
- stage 2: calculate the size of the sample:  $N = 2 \times 1.96^2 \times (0.5 \times 0.5)/0.1^2 = 192$ , which is rounded to 210 in order to work with 30 clusters of 7 people each (WHO model used for vaccination surveys);
- stage 3: calculate the sampling step:  $P = 8\ 000/30 = 266.66$ , rounded to 266;
- stage 4: calculate the cumulative population per village:

	Number of families	Number of accumulated families
Village 1	500	500
Village 2	300	$500 + 300 = 800$
Village 3	350	$800 + 350 = 1\ 150$
Village 4	1 000	$1\ 150 + 1\ 000 = 2\ 150$ etc.
TOTAL	8 000	8 000

- stage 5: draw the first cluster from the table of random numbers. This number must be between 1 and P, that is, between 1 and 266 - for example 150; this is the sampling interval. In the example, the population of village 1 includes 150 ( $150 < 500$ ), and gives the first cluster;
- stage 6: determine the other clusters to be interviewed by adding the sampling step to 150:  $150 + 266 = 416$ . The second cluster is also included in the population of village 1; continue until 30 clusters are obtained:

	Number of families	Cumulative number of families	Numbering of families	Number of clusters selected per village
Village 1	500	500	1 to 500 (150; 150 + 266 = 416)	2
Village 2	300	500 + 300 = 800	501 to 800 (416 + 266 = 682)	1
Village 3	350	800 + 350 = 1150	801 to 1 150 (682 + 266 = 948)	1
Village 4	1 000	1 150 + 1 000 = 2 150	1 151 to 2 1 50 (948 + 266 = 1 214 1 214 + 266 = 1 480 1 480 + 266 = 1 746 1 746 + 266 = 2 012) etc.	4
TOTAL	8 000	8 000		

– stage 7: select the families to be interviewed within the clusters. For each cluster, go to the centre of the village (7 families per cluster, see stage 2). The direction to follow is determined by spinning a bottle or pen then going in that direction and choosing the houses one after another: the first one is chosen at random, and the following are those with the nearest access door. If a family is absent, it is necessary to try to find a family member somewhere else in the village, or return to their house at some other time.

If the end of the village is reached before completing the sample, the process should be started again from the centre, following a different direction.

The main strength of this kind of survey is the possibility of quantifying the results and analysing them statistically.

The main limitation is the lack of people's participation in the survey and the directive way in which the interviews have to be carried out. This means that results, although seemingly good from a statistical point of view, have a risk of some bias in the responses, especially if the interviewer is not skilled enough to avoid it. The staff in charge of the survey have to be well trained to get correct information and truthful responses for every question. As an example, if people know that the organisation involved works on water projects, the people may report that they spend three hours per day fetching low-quality water, even if this is not completely true.

It is always good to complement this survey with a participative method such as focus-group discussion.

### 2.3.5 FOCUS-GROUP DISCUSSION

Focus-group discussions are discussions on a specific topic carried out with people from similar backgrounds. Homogeneous groups are chosen because mixing age, gender or social levels may inhibit some people, especially women, from expressing their views.

This is not a stand-alone method, but can complement another one, a KAP survey for instance, and can explain meanings that cannot be clarified statistically.

A key point of this technique is to listen to, and observe, the participants: the content of what people say is as important as how it is said.

The number of people per discussion can be from 6 to 10, and the number of surveyors required is between two and three:

- the animator: who leads the conversation and raises the topics of interest;
- the note-taker: who writes what's being discussed;
- the observer: who observes the discussion and take brief notes about what they see.

For the equipment needed, pictures can be used to introduce the topics, and a sound recording can be made of the discussion (this is a good solution when there are not three surveyors available).

Box 15.1

Example of a questionnaire used in Ivory Coast.

Date (DD/MM):

Surveyor's name:

Cluster no. :

Woman's name:

Family no. :

Did you attend school?

Yes  No

If yes, what level did you reach?

Primary  Secondary

Where do you take your drinking water from?

*during the dry season:*

*during the rainy season:*

traditional well

traditional well

renovated ACF well

renovated ACF well

ACF pump

ACF pump

HV pump

HV pump

excavated spring

excavated spring

renovated ACF well

renovated ACF well

creeks

creeks

stored rain water

stored rain water

stream

stream

If you do not use the water point provided by ACF:

Why do you prefer to take your drinking water where you do, instead of from the ACF water point? :

there is no ACF water point

the renovated spring is too far away

the water from the pump tastes bad

the waiting time at the improved water point is too long

the renovated well is too far away

the pump does not work

other (specify):

Do you clean the place where you take your drinking water from?

Yes  No

If so, please describe how you clean it:

Do you keep your drinking water separated from the water used for other purposes?

Yes  No

In what kind of recipient do you keep the drinking water for your family?

*during the dry season:*

*during the rainy season:*

barrel

barrel

clay jar

clay jar

basin

basin

bucket

bucket

UNHCR jar

UNHCR jar

other, please specify:

other, please specify:

Ask to see the drinking-water storage vessel: would it be possible to see it?

Yes  No

Does the recipient have a lid (which does not let in light)?

Yes  No



How long does it take to empty the water-storage container?

- more than a day (please specify):
- one day  2 days  3 days
- more than 3 days (please specify):

Could you show us how you clean your drinking-water recipient (this one or another one)?

- Yes  No

If so, please observe and note:

- rubs with their hands and rinses with water
- rubs with a brush and rinses with water
- rubs with soap and rinses with water
- rubs with sand or ashes and rinses with water

In your opinion, how should our drinking water be?

- it should have a good taste
- it should be clear
- it should be odourless
- it should not make you ill
- it should be cool
- other (please specify):

Where do you take the water you use for washing yourself from?

- | <i>during the dry season:</i>                 | <i>during the rainy season:</i>               |
|---|---|
| <input type="checkbox"/> traditional well     | <input type="checkbox"/> traditional well     |
| <input type="checkbox"/> renovated ACF well   | <input type="checkbox"/> renovated ACF well   |
| <input type="checkbox"/> ACF pump             | <input type="checkbox"/> ACF pump             |
| <input type="checkbox"/> HV pump              | <input type="checkbox"/> HV pump              |
| <input type="checkbox"/> excavated spring     | <input type="checkbox"/> excavated spring     |
| <input type="checkbox"/> renovated ACF spring | <input type="checkbox"/> renovated ACF spring |
| <input type="checkbox"/> creeks               | <input type="checkbox"/> creeks               |
| <input type="checkbox"/> stored rain water    | <input type="checkbox"/> stored rain water    |
| <input type="checkbox"/> stream               | <input type="checkbox"/> stream               |

Do you use a traditional shower?  Yes  No

Where do you take the water you use for washing your clothes and kitchen utensils from?

- | <i>during the dry season:</i>                 | <i>during the rainy season:</i>               |
|---|---|
| <input type="checkbox"/> traditional well     | <input type="checkbox"/> traditional well     |
| <input type="checkbox"/> renovated ACF well   | <input type="checkbox"/> renovated ACF well   |
| <input type="checkbox"/> ACF pump             | <input type="checkbox"/> ACF pump             |
| <input type="checkbox"/> HV pump              | <input type="checkbox"/> HV pump              |
| <input type="checkbox"/> excavated spring     | <input type="checkbox"/> excavated spring     |
| <input type="checkbox"/> renovated ACF spring | <input type="checkbox"/> renovated ACF spring |
| <input type="checkbox"/> creeks               | <input type="checkbox"/> creeks               |
| <input type="checkbox"/> stored rain water    | <input type="checkbox"/> stored rain water    |
| <input type="checkbox"/> stream               | <input type="checkbox"/> stream               |

Where do you leave your plates and bowls to dry?

- on the ground  on a table/bench
- in a bowl/basin
- other (please specify):

Where do you leave your clothes to dry?

- on the ground  on a washing line/bamboo line
- other (please specify) :

What are the most common diseases among the children of your village?

1.                       2.                       3.

In your opinion, what are the causes of those diseases ?

- don't know  
 1.  
 2.  
 3.

Do you think that water can carry diseases ?

- Yes                       No                       I don't know

Is so, which ones?

- diarrhoea                       worms  
 others (please specify) :

In your opinion, how can you avoid catching these diseases?

- don't know                       1.                       2.                       3.

What do you use as a toilet?

- the bushes  
 traditional latrines  
 concrete latrines (VIP, HCR)

If there are latrines in your village and you do not use them, why don't you use them?

- there are no latrines                       they are too far away  
 they are dirty                       the door is broken  
 they are smelly                       they are locked  
 they are private property

If there are latrines in the village, do you help your younger children to use them?

- don't have children                       Yes                       No

Do you normally wash your hands after going to the toilet?

- Yes                       No

If so, why do you wash your hands after going to the toilet?

- to prevent diseases  
 cleanliness  
 other (please specify):

What do you do when your children suffer from diarrhoea?

- go to the medical centre / clinic  
 give them traditional medicines  
 give them oral rehydration solution made by yourself  
 buy medicines in the market  
 other (please specify):

How many children of five years or under do you have?

- none                       three  
 one                       four  
 two                       other (please specify):

How many of your children of 5 years or under have suffered from diarrhoea in the last 15 days?

- none                       three  
 one                       four  
 two                       other (please specify):

**Table 15.IV: Various tools that can be used for focus-group discussions.**

Tool	Information
Three-pile sorting	People's knowledge concerning hygiene issues Risk practices and their causes Possible safe target practices People's perception about their hygiene behaviour
Community mapping	Contextual information Resources, hygiene facilities
Seasonal calendar	Contextual information Time availability of the people Culture, habits
Task analysis	Target audience for the programme Gender roles

A focus-group discussion can be used to introduce ideas or messages to the group, so it is also a tool for the implementation phase.

There are many different ways to carry out a focus-group discussion. While in some cases it can be simply a direct discussion between surveyors and participants, in others particular tools can be used to facilitate the discussion as described below.

### 2.3.6 THREE-PILE SORTING

The objective of this method is to understand the population's point of view concerning different hygiene practices. First some drawings of different hygiene practices (defecation, hand-washing, throwing the waste to the river etc.) are shown to groups of participants, who should then decide after a discussion whether the practice shown in the picture is good or bad, and why. If the drawing is not clear for them or if there is not a consensus at the end of the discussion, the picture will be classified as in between.

When using this method, it is very important to take notes of the comments made and to attach them to the corresponding pictures.

This method is good for starting the study because it breaks down initial barriers between the assessment team and the population. It is also an opportunity to introduce sensitive subjects such as defecation, latrines etc.

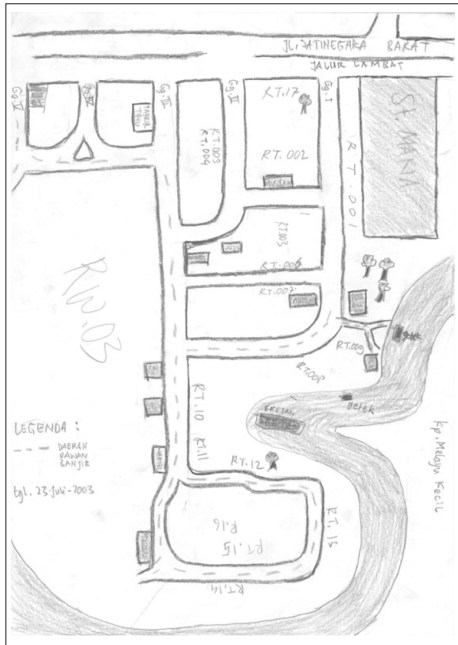
### 2.3.7 HISTORY LINE

The objective of this method is to understand local history as told by the elders of a community. This experience will enable learning about different issues:

- how local, national and international events are perceived by the population;
- how people perceive themselves;
- the history of specific issues that are of interest to the programme (water management etc.).

It is important to introduce the assessment team before starting the discussion and to tell the participants what are the objectives of the study and explain that the information will not be used against them. Then the participants use local materials to mark the events that have been important for them, on a line that represents time.

This method also helps to establish good relations with the members of the community and especially with the elders, who tend to be forgotten key informants.



**Figure 15.4: Community map of a neighbourhood in Jakarta (Indonesia).**

### 2.3.8 COMMUNITY MAPPING

In this method the participants design a map of their local environment, showing places that are important for them, and others that are interesting for the study: places where people collect water, sites that are important for health and hygiene, sanitation facilities (where people throw their rubbish, go to defecate, wash their clothes etc.)

While people are making the map, it is important to consider that what is happening in the group (discussions, ideas raised, attitudes towards specific issues etc.) is as important as the map itself. The map should provide information about physical places and about the attitudes of the people towards them.

### 2.3.9 SEASONAL CALENDARS

This method is used to understand the timeframe regarding climate, diseases and the livelihood activities of the population over the year. As with the methods described above, it requires skilled surveyors.

When talking about disease outbreaks, a ranking system is also developed in order to highlight what is high, medium or low incidence.

### 2.3.10 GENDER ROLES/ TASKS ANALYSIS

The objective of this is to answer the question “who does what?” in terms of gender. After having observed what are the local arrangements concerning tasks and resource management, researchers try to understand which tasks are done, and which resources are managed, by men, women or children.

One of the most commonly used systems is to prepare several cards with a different task drawn on each one. The group of participants look at each of the pictures and then reach a consensus on who is performing each of the described tasks. The cards are classified in three piles (men, women and both/not clear) and comments about each of the activities are noted.



**Figure 15.5: Making a seasonal calendar.**

### 2.3.11 WATER ANALYSIS

Water analysis is a complementary method that can provide objective information about the sanitary risks caused by the bad quality of drinking water.

The difference between the quality of water at the point of consumption and at the collection point provides information about how people handle the water, and the need for improving their practices in terms of water collection, transport, treatment, storage etc.

If the quality of the water collected from a safe water point is bad, it means that efforts have to be made to improve water handling.

## 2.4 Recruitment and training of the assessment team\*

### 2.4.1 CHOOSING THE ASSESSMENT TEAM

In general the assessment team should be chosen from the project staff and the local population, and should include:

- Somebody who thoroughly knows the community where the study will be carried out.
- Somebody with good writing skills.
- Somebody who speaks and understands the language of the target community perfectly.
- A senior staff member with knowledge of the target area and extensive experience of this kind of project: this person can be useful when planning the assessment and for translating the outputs of the assessment into project aims.

Every member of the team should be:

- Respectful of the population.
- Able to stay in poorer areas than they may be used to living in.
- Willing to learn about local people and their culture.
- As distant as possible from political leaders in the areas.
- Able to maintain a good team spirit with the other surveyors.
- Preferably a native speaker of the target population's language.
- Trusted by the population

If there is a conflict in the target population, team members should not belong to one of the sides in conflict.

---

\* Adapted from Unicef 1999.

## 2.4.2 TRAINING THE ASSESSMENT TEAM

Once the study team is chosen, it is necessary to prepare them for the assessment with different training aspects:

- Sensitisation for the assessment work and what it means for the interest of the community.
- Acquiring the technical knowledge and skills required for this kind of investigation.
- Improvement of interpersonal skills (presence, style of speech, greetings etc.) in order to make people feel comfortable with the presence of the surveyor. The objective is to avoid the “observer effect” where people react in a different way because of the presence of a stranger.
- Involvement of the team in planning the assessment in order to increase their capacities to lead the study by themselves.

### *Training contents*

First of all the trainer will have to find out what are the existing skills and knowledge of the team in order to orient the training to strengthen weak points and to benefit from the knowledge of the more skilled team members in helping the others learn.

The training should be as participatory as possible and the approach should be to help the team learn rather than to impose concepts.

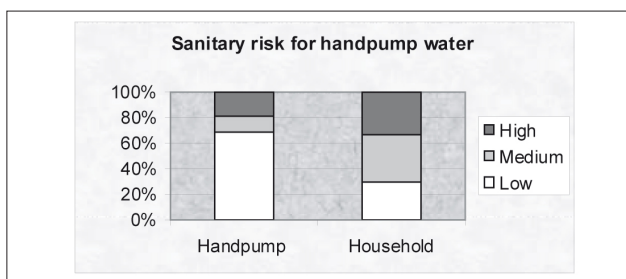
The skills to be practiced during the training are:

- Water, sanitation and hygiene issues: relationship between water use, sanitation, people’s behaviour and diseases.
- Observation skills: the trainee needs to learn to separate the trivial details from the important aspects and to write a systematic detailed description of what is observed, avoiding possible biases.
- Interviewing skills: the members of the team need to be able to establish a good rapport with the interviewed person and to listen keenly.
- Moderating skills and discussion techniques: many of the assessment techniques consist of a discussion with community members. The discussions will be moderated by the surveyors, who need to be skilled in terms of discussion management and discussion techniques such as focus groups, gender roles, seasonal calendars etc.

## 2.5 Analysis of results

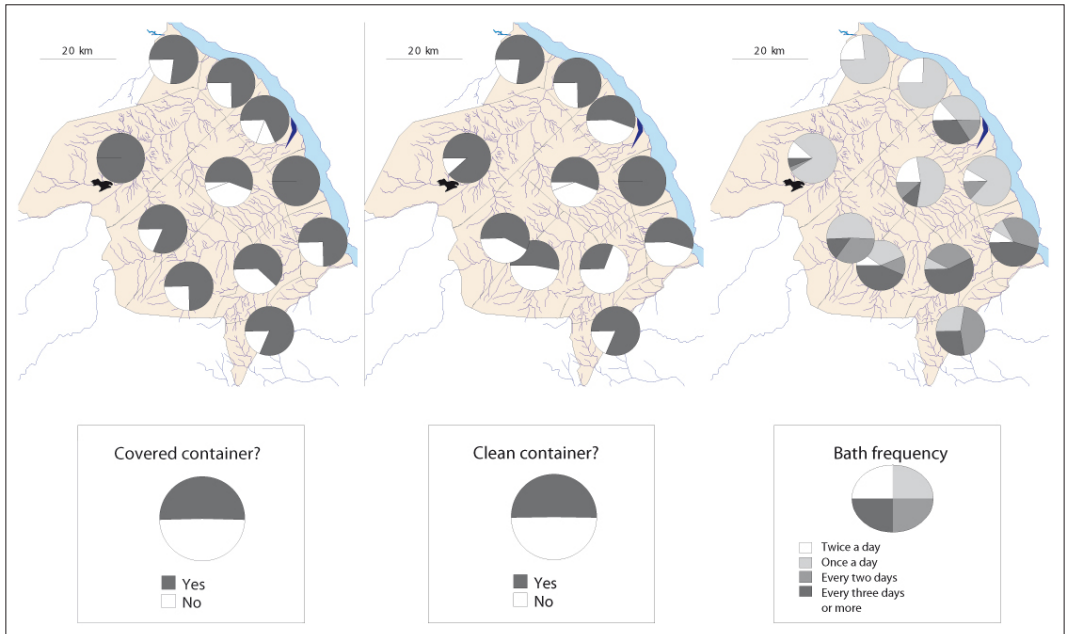
Once the results of the assessment are analysed it should be possible to answer the questions “what is the problem?” “what are the causes of this problem?” and “what is the role of human behaviour?”. The steps in the analysis of the assessment information are:

- Preparation of a summary of the data in tables or graphs to facilitate the preparation of the report and to allow a clear presentation of the information (see Figures 15.6 and 15.7).



**Figure 15.6: Sanitary risk for handpump water.**

**The results of a study carried out in Myanmar show that water becomes contaminated between collection (at the handpump) and consumption (in the house). It suggests bad water-handling practices.**



**Figure 15.7: Use of G.I.S. for analysing the results of a hygiene assessment in Mozambique (1999).**

- Comparison of the information with the preliminary set of questions prepared when making the detailed assessment plan. This will assist in interpreting the information and identify if something was missed during the assessment process.

- Distribution of the report. All potential partners should have copies of the report and it should be translated into local languages in order to share the information with local institutions and the community assessed.

### 3 Programme planning and design

The programme moves to the planning and design stage when the information from the assessment has been collected, analysed, and presented. The emphasis in this stage of the programme is to set goals, if any at all, and to design the methods to accomplish these goals. Continued input from all parties involved in the assessment is essential as decisions are made.

#### 3.1 Setting Programme Goals

Now it is the time to answer the question “What are we going to do and how?”. Programme goals are set based on the results of the assessment phase of the programme.

The following 6 myths of hygiene education identified by Unicef & LSHTM (1999) are common ingredients of failed hygiene-promotion programs. These ideas ought to be dismissed while setting the programme goals.

*People are empty vessels into which new ideas can simply be poured.*

Introducing new ideas and concepts can create confusion and incomprehension when a society already has coherent explanations for diseases.

*People will listen to me because I'm medically trained.*

Health personnel may believe that the fact they have been trained and are qualified will automatically mean that they will be listened to and believed by the community members. A health worker who is thought to be saying, "it's your fault your kids get sick and die, it's because you are dirty" will gain little respect from the communities.

*People learn germ theory in a few health-centre sessions*

Even in the best of circumstances, helping people learn new ideas about hygiene and disease (when this learning is necessary for hygiene-behaviour change) is a long, slow process.

*Health education can reach large populations.*

If a health-promotion programme were to reach all the mothers in an area it would require an impracticably large number of hygiene-education sessions.

*New ideas replace old ideas.*

Hygiene promotion often just adds one more idea about disease without erasing the old ones.

*Knowing means doing.*

We cannot assume that education about germs and diarrhoea will lead directly to behaviour change, or have a major impact on diarrhoeal diseases.

### 3.2 Selection of target practices

Programmes often take on too many goals. To be effective, the programme must focus on a few practices selected among those identified during the assessment.

The criteria for targeting areas for change in practice are:

- 1) Importance of the new practice in terms of disease reduction.
- 2) Ability of the people to adopt this practice: do they have the means?
- 3) Willingness of the people: will they want to adopt the new practice?
- 4) The impact achieved for the effort required.

Although all the suggested practices mentioned in Table 15.V can be important, it is not possible to include all the safe practices on the list, and five were chosen because of their greater importance and feasibility in that context: hand-washing (impact on three different problems), use of latrines and management of children's excreta (complementary to the latrine programme being implemented), cleaning and maintaining the water point (complementary to the construction programme being implemented), and refuse disposal (as it was one of the main problems identified).

*Testing the practices chosen: behaviour trials*

It is recommended to check that the practices chosen to replace the risk ones are feasible and realistic. One method for testing this is the behaviour trial, in which a limited number of volunteers are selected from among the target audience, after presenting them the results of the study in the community and the advantages of adopting the new practices.

The volunteers (women in general) adopt the safer behaviours during two weeks and a member of the team visits each volunteer at home every day in order to advise and to observe the progress. At each visit, the observer will note every event which occurred in the process of adopting the new practice and seek the answer to different questions:

- Is the practice adopted?
- What are the difficulties and how are they solved?
- What can make it easier to adopt the new practice?
- Does the volunteer like the practice? Why?
- What were the costs and the benefits for the volunteer?



**Table 15.V: Example of targeting safe practices to promote.**

Problem	Risk behaviour	Safe practice to promote	Comments
Presence of stools in human environment	People don't use the latrines Mothers throw the baby faeces in the street	People use the latrines Parents throw baby faeces into the latrine pit	Latrines recently installed
Contaminated drinking water	Different buckets used to collect water from the well People touch the water with dirty hands Bad water-point maintenance People don't clean water containers Water containers not covered	All the well users use the same collection bucket People don't touch the water People wash their hands People clean and maintain the water point People cover the water containers People boil the drinking water	In this culture people must touch the water No wood available for boiling water
Contaminated food	Food kept on the ground People touch the food with dirty hands	Food kept in a cupboard People wash their hands	Cupboards too expensive
Lack of personal cleanliness	Dirty hands People take a bath once a month	People wash their hands People take a bath once a day	Limited availability of water
Dirty environment	Rubbish thrown in the street Stagnant water	People burn or bury their rubbish People clean and maintain drainages	

At the end of the process the sequence of events are summarised in a table as in the following example:

Practice	Percentage of people adopting this practice	
	Initial	Final
Washing hands after defecating	10%	30%
Burying or throwing children's stools into the latrine	5%	18%

This technique will allow the new practices chosen for replacing the risky ones to be redefined or modified.

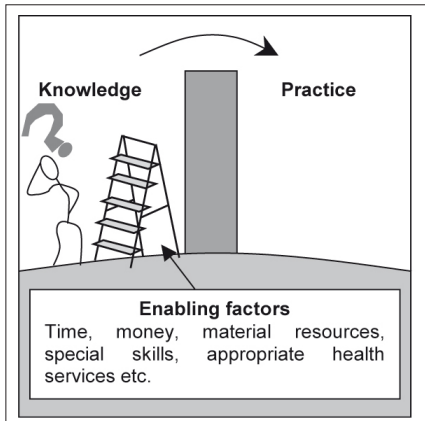
### 3.3 Selecting the target audience

The in-depth assessment should have identified which people carry out risky hygiene practices. But people do not act in isolation; they are members of family groups and of a wider society that has a great influence on what they do. Communication to encourage behaviour change should be directed at the people who make the key decisions in the family and the community.

It should also be considered at what stage of people's life it is better to reach them with the chosen message (pre-school, school, young, adult, elderly).

### 3.4 Designing the message

Now it is necessary to decide what is the best way to convince the population to replace the risk practices by the safe target practices.



**Figure 15.8: Enabling factors.**

This means finding out from the primary target audience what they like about the safer practices. Communication strategies are then built around these positive values.

The methods used to find out what people like about the safer practices (change in the risk practice) can include behaviour trials, semi-structured interviews and focus-group discussions. With the information obtained a positioning statement is produced that picks out a key advantage and a key goal for each target practice.

#### *Examples*

*I want to clean up stools and throw them in a latrine because ... then people won't step in them and my neighbours will respect me.*

*I want to wash my hands with soap after contact with stools because... it leaves my hands smelling nice and I feel good when I feel clean.*

It is not advisable to position the messages around the fear of disease and the death of children. For example, messages about diarrhoea don't always make sense to people, and tend to revolt them because they are profoundly unattractive. A message about having healthier children and fewer medical costs is more positive and attractive.

A message will only be effective if the advice presented is relevant, appropriate, acceptable and put across in an understandable way. In the configuration of the message it is necessary to play with the understanding of health that people have and the existing influences on their behaviour (Figure 15.8).

Good advice should:

- be defined according to the results of the previous assessments;
- recommend a target practice previously identified;
- respect the social environment and culture of the community;
- consider the enabling factors: it should be affordable and realistic;
- require a minimum of time and effort;
- be felt as a need by the community;
- imply a noticeable benefit;
- be easily understood.

### **3.5 Communication channels**

The level of communication should be chosen depending on the kind of message to be transmitted, the size of the target population and the capacities of the team. The channels used will depend on the level chosen:

- Individual/family level:
  - one-to-one advising;
  - patient education;
  - home visiting.
- Community level:
  - community participation/discussion;
  - group teaching;
  - exhibitions;
  - demonstrations.
- Regional/national level:
  - mass media;
  - social mobilisation.

On the basis of the assessment of the target audience, the team then decides which channels of communication are likely to be most effective and within the programme budget. The communication objectives need to be translated into activities and events designed to get the message across. These are commonly known as communication supports. Communication supports use the senses of vision and hearing to convey messages.

The various supports can be classified into:

- *Audio-visual*: a support that is seen and heard; it can include theatre, video, film and teaching with audio-visual materials.
- *Oral*: a support that uses words alone to pass messages; this may be in the form of a story, a song, a radio announcement or a visit from a health worker.
- *Written*: includes leaflets, posters and articles in the press.
- *Visual*: includes posters, stickers and flip-charts.

In choosing the supports for the communication plan there are various points that should be kept in mind:

- *use of local idiom*: so that people feel that it relates to them;
- *attractiveness*: so that it pulls people in;
- *repetition*: so that messages are retained;
- *easy to understand*: so that nobody gets confused;
- *participatory*: an exchange of views is most effective;
- *provocative*: so that the messages are memorable and get discussed;
- *show by example*: so that the new behaviours are seen to be possible.

When choosing the communication channel it should be remembered that:

- we retain just 10% of what we hear;
- we retain about 30% of what we hear and see;
- we retain more than 60% of what we do.

Therefore actions are more effective than words in retaining information.

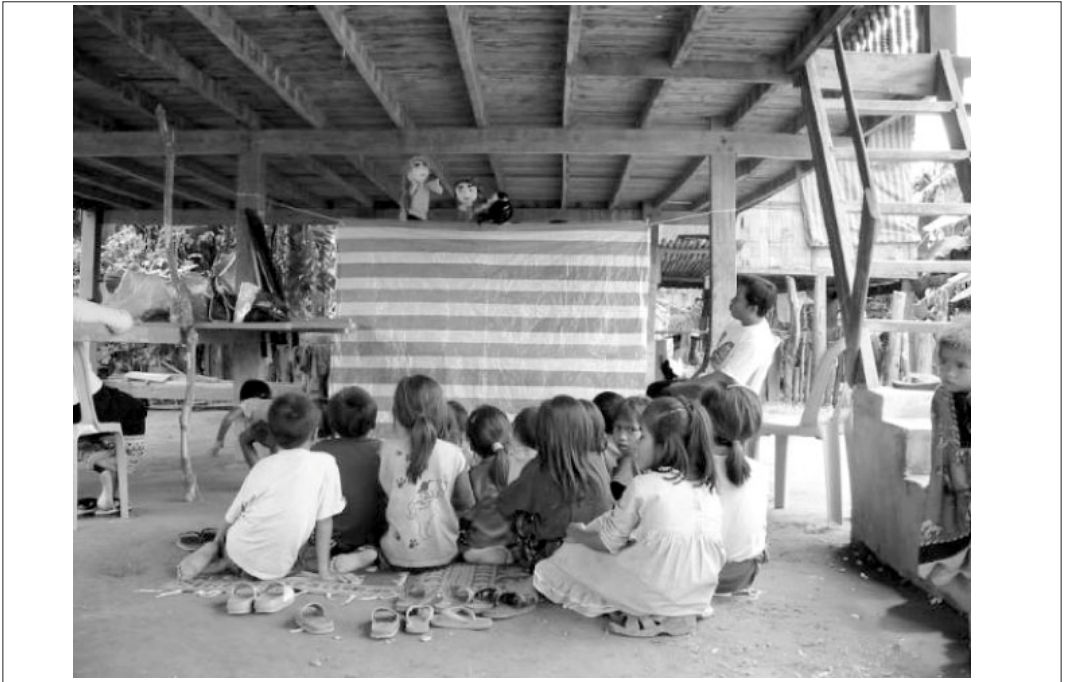
Sometimes there may be materials already developed and available for use in the programme. These ready-made materials can save time and money, but it is important to consider who was supposed to be their original target audience. It is a common mistake, for example, to use a tool that was designed for children for communicating with adults.

Below is a list of some of the tools more frequently used in ACF programmes.

### 3.5.1 PICTURES

Pictures and images can be used in different ways:

- as a support for face-to face communication;
- as a component of printed media (newspapers, t-shirts, stickers etc.).



**Figure 15.9: Use of puppets for hygiene promotion in Laos.**

The following points should be considered when using pictures:

- make details accurate and objects familiar to the audience;
- avoid distracting details;
- be careful when using a sequence of pictures as it can create confusion;
- use no more than one message per picture;
- pre-test with samples of the intended audience.

### 3.5.2 THEATRE/ PUPPETS

Generally, this is a tool that has the advantage of being attractive for the audience. Experience shows that the impact of this activity tends to be higher than using simple oral sessions.

Drama or popular theatre can also be used to promote community participation. Following the show, people can be involved in discussing issues and suggesting solutions. Sometimes this can also happen during the show.

Puppets are a form of drama with a lot of potential for hygiene promotion. In some countries, such as Indonesia, puppets are a tradition. One advantage of puppets is that they can transmit sensitive messages that would not be possible for an actor in a play. There are messages that the population would not accept coming from a person but they will listen if it is just a puppet talking.

### 3.5.3 STORYTELLING

While some of the proposed methods require a certain level of formal education, storytelling is closer to the way most people think. In addition, people remember things better explained in this format than in a formal talk or conference.

The story should be such that people identify with the figures and the situations presented.

### 3.5.4 SONGS

In some countries, such as Sierra Leone, music combined with dance is used traditionally to tell events and stories. The singers of the village are quite appreciated by the community and people listen to what is said in their songs. This channel has a powerful effect on emotions and it was used by the hygiene team in this country with good results.

Songs can be used as media (publication of CDs for example) or as a component of hygiene-promotion sessions in villages or schools.

### 3.5.5 VIDEO, SLIDES ETC.

These kinds of tools are also good because of their attractiveness, but they should be used with care, because sometimes the tool itself takes more attention from the audience than the message it is supposed to transmit, as it is such a novelty, given the standard of living of the people watching.

### 3.5.6 MASS MEDIA

It is also possible to include messages as advertisements in newspapers, on the radio and the television etc. In this case it is always good to present the message and discuss it with samples of the target audience before publishing or broadcasting it.

These tools are mainly used to create an awareness about a topic, after which the teams carry out a face-to-face communication in order to reinforce the process of behaviour change.

## 3.6 Selection of the communicators

The question now is who is going to be responsible for transmitting the message to the target audience. The people chosen should be as close as possible to the target community and, if possible, should belong to the community.

This can be achieved in several ways:

– Recruitment of staff by the organisation to implement the programme directly. In this case it is recommended that they are native to the region of the target communities. As an example, in Mozambique, ACF developed the hygiene programme through a team of 6 promoters who originated from the different areas targeted by the project. They knew their respective areas of work thoroughly and they were also known and respected by the people in the different communities with which they were working. Each one of them was based in their respective work area and only left their area for a few days at the end of each month to meet the other fieldworkers in the district capital to discuss progress and write a monthly activity report.

– Working through a local NGO.

– Working through groups of local people such as theatre troupes.

– Training of trainers: in this case the agency staff is composed of trainers who will train members of the community, who in turn will be in charge of passing the message to the target audience. In this case there are two options:

- training of health or education staff: health workers, teachers, midwives etc.;
- training of one or more Community Hygiene Facilitators (CHFs), who are people from the community, chosen by the members of their community.

### 3.6.1 TEACHERS AS HYGIENE COMMUNICATORS

In the planning phase it is important to remember the schools. Children are usually an important part of the target audience, and training teachers for health is a good way to increase the project's impact and guarantee some sustainability.

Working with schools and children has several advantages:

- Most of the time, children belong to the target audience as they are more exposed to diarrhoeal diseases.
- Children are more open than adults to receiving messages. The message gets across more easily as they have fewer established habits, making it easier for them to adopt the new, safer practices.
- Sustainability: working with children is an investment for the future. If they adopt a new practice, it will be with them throughout their lives. Furthermore, if teachers are trained to include hygiene in their programmes, this provides some continuity after the organisation leaves.
- Children adopting safe practices in their homes can be a good seed to spread these practices among parents and then the entire community.

There are good examples of this kind of activity in Myanmar, where children paint newly-constructed latrines with drawings showing safe practices for excreta disposal (washing hands after using the latrine, keep the latrine clean etc.) or East Timor, where a different range of activities, such as role plays and songs, are organised with the teachers. In both cases the teachers are trained during the first sessions implemented by the project team, and then carry out the activity by themselves afterwards with the help of an educational kit.

### 3.6.2 COMMUNITY HYGIENE FACILITATORS

In ACF programmes, it is becoming more usual to work with CHFs, who are members of the community, trained by ACF staff to be a resource person for their village concerning hygiene issues.

Even though the old proverb says that nobody is a prophet in his own land, it is true that people tend to understand somebody who belongs to the same community better than an outsider. Furthermore, the fact of seeing what a member of their own community is able to do can be a stimulus for them.

The main advantages of working with members of the target audience as hygiene promoters are:

- Local knowledge: they know the community well.
- Logistics: as the sensitisation and the transmission of the message are done by a member of the community, the volume of activity required of ACF staff is reduced.
- Sustainability: the promotion of safe hygiene practices depends on a member of the community, so it becomes independent from the first intervention.

In order to encourage the sustainability of the hygiene facilitators' activity, they are not given a salary for their work. They can be given incentives such as tee-shirts or caps, or the opportunity to do some training outside the village. In some cases, the fact of being a resource for health in the village makes the facilitators feel useful, respected and recognised by the rest of the community, and this can be enough reward for them.

The roles of the Community Hygiene Facilitator:

- *Promotion of improved practices*, through their own behaviours, discussions, and activities such as home visiting. The CHF is should be someone who is respected in the community so that their point of view will be listened to.
- *Monitoring and reporting*: the CHF is a window for the agency during the implementation phase and after. They can provide updates of the situation in the community in terms of diseases, adoption of new practices etc. If they are well trained, they can provide regular and good first-hand information. They can be provided with a simple reporting sheet with a table to fill in periodically (on a weekly or monthly basis) to compile the information of interest (births, deaths, number of diarrhoea cases, state of cleanliness of the water and sanitation infrastructure etc.)
- *Treatment of diarrhoea cases*: in places such as Sierra Leone, the CHFs are consulted for cases of diarrhoea. They may administer oral rehydration solution, and/or contact the closest health centre if necessary.

### *Choosing the Community Hygiene Facilitator*

The CHF's must be chosen by the community members, but there are some points that should be considered, to minimise the risk of failure:

- The CHF should be a representative of the target audience, which often comprises the poorest people in the community. Sometimes the head of the village takes the decision and chooses somebody from their family or circle of friends even if they don't have the capacity. This should be avoided as far as possible.
- In general, women are more suitable for the role of CHF. They are usually in the risk groups concerned, and they are more involved in the day-to-day life of the community.
- The CHF should be able to read and write, as in some cases they have to write a report.
- The CHF should be somebody who will stay in the community and doesn't foresee leaving. Young people with higher levels of education often aspire to leave their village looking for new horizons, so older people are often more suitable.
- The facilitator should have no link with political factions and should not be likely to take part in a possible conflict. They should be respected by everybody in the village and their opinion should be listened to by a majority of the community.
- The election of the CHF must not be done too quickly. Enough time should be allocated to this process to avoid failures.
- The most important point is that the CHF should be motivated, committed to social justice and able to demonstrate solidarity with the most vulnerable.

### *Training of the Community Hygiene Facilitators*

A workshop can be organised to train the elected CHF's from the communities targeted by the project in order to train all of them at the same time and to allow them to exchange experiences and points of view. Usually this training takes between one and two weeks (it depends on the subjects), but this has to be adapted, depending of the availability of the trainees. After the workshop and during the ongoing programme, the agency trainers visit them periodically to monitor their activities, answer their questions, and give some advice for solving possible problems.

In some cases, when the CHF's acquire enough skills and experience, they become trainers or members of the project team.

## 3.7 Consolidation of the communication plan

By this stage the participant groups addressed by the safe water and environmental sanitation intervention have been chosen. The project team should know a lot about them through the research they have conducted. They know the behaviours and practices to recommend and advocate.

They know the channels and media they want to use: interpersonal for developing behaviours of most people; the mass and traditional media for modelling behaviours and giving some information; and asking influential people at all levels to give testimonials and give support for the intervention, thus establishing social norms and creating a climate for change.

It is important for the final communication plan to be a product of team effort. The process of drawing up the plan will validate the various contributions that partners and other team members have given in research, preparing plans or designing strategies. It is also a way for everyone to buy into the communication programme and to assure its smooth operation.

### *Pilot, Testing, and Revision*

Testing is very important because the communication materials will not be got right the first time. The poster designed to show a mother washing her hands may look to the target audience like she is taking a pill, or the radio ad produced may be so funny that it distracts from the message.



Trial versions should be made of all of the material, which should then be tested. Prototype posters can be taken to a school or a health centre and people can be asked what they see in them. Small focus-group discussions with representatives of target groups can be held to evaluate tapes of radio programmes. Some members of the audience can be interviewed after the first show of a play to see what they retained. Health workers can try out materials and give feedback on their usefulness.

Once the material has been tested and revised, it is wise to start the programme on a small scale and pilot the material. It should be monitored and then evaluated, and any procedures that may seem inadequate should be revised. Then the main programme can be launched in all of the areas that have been planned.

### 3.8 Distribution of hygiene kits

It is possible that the target practices chosen to replace the risky ones require certain resources that are not available to the population. This is often the case in emergency situations and with highly vulnerable populations. In this case, it may be necessary to distribute items that are needed by the affected population to carry out the safe practices.

Some examples of items to be distributed are:

- *Soap*: this should only be considered in case of an emergency (distributing soap is not normally sustainable).
- *Chlorine*: it is distributed in case of cholera epidemics and diarrhoea outbreaks. It can be used for disinfecting wells or treating drinking water. As it can be dangerous when it is incorrectly used, the people who are going to handle it should be well trained.
- *Cleaning tools*: for water containers, households or water points.
- *Water containers*: adapted to the habits and needs of the people in terms of collection, handling, transporting and storage of water. It is common to distribute one container for water

#### Box 15.2

##### Example of hygiene kits distribution in Laos.

In Laos, unsafe water handling practices were found in the assessment phase. To ensure good quality of water at the household level, it was necessary for people to protect water during transport and storage and to treat it by boiling. The problem was that people had no containers to transport and store the water and no means to boil it. These elements were not available for the population at an affordable cost for them, and so a distribution of hygiene kits was decided. Evaluations carried out years after the distributions demonstrate that people started to boil their water and modified their risk practices, motivated by having the necessary resources.

The family hygiene kit included the following items:

- a nail clipper (people generally eat with their hands and share the food);
- 2 plastic buckets to fetch water to replace low capacity and unhygienic traditional gourds;
- one 60-litre plastic water container with lid to store water at home, to reduce the frequency of water collection;
- one plastic scoop with handle to collect water from the container in a hygienic way;
- one kettle to boil drinking water;
- a set of 6 plastic glasses;
- a thermos flask;
- one bar of soap and one brush;
- impregnated mosquito nets (the number of bed nets distributed per family was chosen after a household visit to determine needs. One small bed net was given as a spare for members going out to work overnight in rice fields etc.).



collection and transport (between 5 and 20 litres), and another for storage (between 30 and 100 litres). It is also possible to include a water bottle in the kit to allow people to have clean drinking water while they are working far from home.

– *Whistling kettles*: whistling kettles enable people to disinfect water correctly by boiling.

– *Filters*: if it is not possible to treat the water by boiling it due to cultural issues or lack of cooking fuel at reasonable prices, other means such as clay or sand filters (with easy and affordable maintenance) can be distributed at household level.

– *Nail clippers*: as dirty nails are an important transmission route for pathogens.

## 4 Monitoring and evaluation

### 4.1 Monitoring

The objective of monitoring is to review how the programme is being developed at all its stages, in order to improve the results.

After each session of hygiene promotion, the hygiene promoter fills in a sheet with the information concerning the place, the date, the time, the audience at the beginning and at the end of the session, their attitude (bored, participative etc.), the number of people sick with diarrhoea, the cleanliness of the water point etc. Each promoter has a sheet for the compilation of the data for one month.

**Table 15 VI: Examples of monitoring different aspects of communication activities.**

	Poster	Session	Media
Visibility	The poster was placed in the church and reached almost all the population	The session was carried out when the women were working in the field, and few people came	The radio programme was broadcast at lunch time, and nobody heard it
Interest	The poster was too small to catch attention	The session was so boring that half of the people left before the end	The programme was a radio series taught by a theatre group about real and common stories happening in the communities. As people recognized their own life in the stories, the audience was large
Understanding	People thought that the mosquito in the poster was the solution for malaria	The field worker used the local language and the same words and expressions used by the community	The linkman used complicated words and nobody understood
Acceptance	People think that malaria is produced by witchcraft and they don't believe the message even though they understood it	When the field worker said that diarrhoea was transmitted by faeces, people started laughing	The linkman was a very well known and respected traditional leader so the people trusted what he said
Behaviour change	Some people don't have money to buy a mosquito net	People wash their hands with soap because they spend less money on medicines	The women wanted to follow the advice, but they did not have means to put it into practice
Improvement in health	The health centre started distributing mosquito nets at very low cost and malaria decreased	People started washing their hands, but the quality of the drinking water was so bad that no improvement in health occurred	People understood the message, believed it and followed the advice, but health centres were not functioning

This information coming from the different members of the team or the CHF's feeds into a meeting with the team at the end of the month, about the work that is being done, the problems encountered and the positive points remarked.

The result of this discussion can be compiled in a table as shown in Table 15.VI.

In common with all programme aspects, health-promotion activities need to be carefully supervised and monitored. Periodic reviews will help ensure that activities are being carried out, that they are reaching people, and that they are effective. The results will allow modification of the programme to make it more effective.

## 4.2 Evaluation

Evaluation attempts to take an overview of the whole project and define to what extent it has fulfilled its objectives, and how and why it has fallen short of them, if that is the case. Evaluation also attempts to assess if there have been any unforeseen consequences of the project activities. While monitoring should take place from the onset of the project, evaluation takes place only after enough time has elapsed for changes to take place (see Chapter 2). This stage entails both the analysis of overall impact and the application of analysis for planning future activities.

The methods used for carrying out an assessment are also useful for evaluating the impact of the programme.

Evaluation and monitoring may overlap. It is important to monitor whether a new behaviour is being carried out and also to evaluate whether the new behaviour has changed the outcomes that were the initial concern.

Changes in practices and improvements in health are longer to achieve than changes in knowledge. Short-term evaluations can be done during the programme (monitoring) and at its end. But longer-term evaluations, some time after the completion of the programme, can also be done in order to evaluate the real impact of the activities.

## 5 Example: Laos

Specific objectives and results to obtain for the hygiene education activities were:

- Increased hygiene awareness and improved hygiene practices among communities in 20 villages, through village hygiene-education sessions (in the local language) and provision of hygiene kits.
- Increased malaria awareness and improved malaria-prevention practices in 52 villages through: village malaria-education sessions (in the local language) and provision of impregnated mosquito nets.

In order to achieve the expected results, the general methodology established was the following:

### *Needs assessment*

The first step, before starting the health-education programme itself was to assess needs through a KAP survey related to hygiene or malaria-prevention knowledge and practices. The purpose of the survey was to establish villagers' habits with regards to hygiene in order to design an appropriate hygiene-education programme, responding to the particular needs of the population. Other qualitative surveys were also conducted in parallel through focus-group discussions (occurrence of diseases etc.).

### *Results of the assessment*

- Diarrhoea and malaria were the most recurrent diseases in the villages. For instance, in 12 of the target villages where focus-group discussions were held before the start of the health-education sessions, the most recurrent disease was said to be either malaria or diarrhoea. Only in 2 of those 12 villages was another disease (coughing) said to be more common than either diarrhoea or malaria.

### Box 3

#### Example of an evaluation in Laos.

Impact measurement of a part of a hygiene-promotion programme in Laos (2003). The results come from a KAP survey carried out at the beginning and after the end of the programme. They demonstrate changes in knowledge, practices and health outcomes.

	Result before programme	Result one year after the end of the programme	Comments
<i>Drinking water</i>			
Boiling drinking-water	22%	98%	Distribution of kettles
Using a bucket for water transport	16%	94%	Distribution of buckets
Using a gourd for water transport	58%	1%	
Using an old drum for water transport	21%	4%	
Washing water containers with soap	18%	67%	
Collecting water more than once per day	81%	13%	Distribution of buckets and water-storage containers
<i>Link between water and disease</i>			
Knowing that water can transmit diseases	37%	93%	
Not knowing how to prevent diarrhoea	83%	15%	
Doing nothing when a child in the family has diarrhoea	51%	10%	
Having at least one person in the family affected by diarrhoea during the last month	74%	36%	

- Villagers had very poor knowledge about the origin of those diseases, the means to protect themselves and the basic treatments to take (in the case of diarrhoea in children for instance).
- Even if the villagers were taught about the above-mentioned problems and their solutions they did not have the financial resources to buy the necessary equipment. For instance, 53% of people never boiled water because they could not afford a kettle, and none of the families without a mosquito net could afford to buy one.
- Therefore, to be able to have a positive impact on malaria and diarrhoea reduction, people also needed to be helped through distribution of equipment.

#### *Design of hygiene-promotion sessions*

The syllabus of hygiene-education activities was then designed, based the results of surveys. Four distinct sessions tackling different themes were to be carried out in each target village.

The themes of the four activities were:

- 1) General hygiene (hygiene when preparing meals and eating, personal hygiene, cleanliness of the environment and what to do with rubbish etc.). Distribution of nail clippers and soap.
- 2) Diarrhoea (causes, related health hazards, actions to be undertaken and means of prevention). Preparation of oral re-hydration solution.
- 3) Clean water (hazards linked with contaminated water, means of prevention, safe hygienic practices for water collection, transport, storage and consumption). Distribution of hygiene kits. Collection of a small amount of money for each hygiene kit distributed, to create a small revolving fund within the village.
- 4) Malaria (causes, related health hazards, means of prevention, actions to undertake in case of illness). Distribution of mosquito nets after inventory of needs in each household. Distribution of insect-repellent soap bars. Impregnation of bed nets together with villagers.

### *Educational tools and methods*

As the results of health-education sessions depend mainly on the information being understood, special attention was given to the following parameters:

- The vast majority of villagers, especially women, could not speak or understand the Lao language. Hence, it was of utmost importance that health-education sessions were carried out in ethnic minority languages. This was taken into account from the very beginning of the project, and ACF recruited Akkha speakers (most of them being native speakers). Therefore no translation was required in most target villages (16 villages out of 21). As far as Kouï villages were concerned, when potential translators were not available in the village, some were hired from the target villages of the previous project (Phonsamphan village).
- Most people were illiterate. As a result, educational tools needed to be mostly pictorial and/or auditory. Hence, various educational tools including posters, game posters, card games, videos (in Kouï and Akkha ethnic languages) etc. were used.

Villagers were divided in three groups in each village (women, children and men). One distinct session was held for each group. To keep the participants' attention and stimulate their involvement, small rewards such as sweets for children, soap bars and ECHO/ACF malaria-prevention tee shirts were distributed to the most pro-active people. Moreover, educators called for testimonies and experiences to get examples of real situations and make sessions livelier.

The evaluation of the programme was carried out through a KAP survey before starting the programme and one year after its end. The analysis of the survey results was done with a simple calculation sheet. As an example, the proportion of people washing their hands with ashes or soap increased from 16% to 80% and the proportion of people boiling drinking-water rose from 22% to 98%.

# Water-supply management

<b>1</b>	<b>General objectives</b>	576	<b>3.2.2</b>	<b>Committee members</b>	589
<b>2</b>	<b>Types of management</b>	577	3.2.2.1	President	589
2.1	Actors in charge of water-supply management	577	3.2.2.2	Technician	590
2.2	Context and management	580	3.2.2.3	Treasurer	590
2.2.1	<i>Rural areas and isolated and dispersed communities</i>	580	3.2.2.4	Hygiene promoter	591
2.2.2	<i>Urban and peri-urban areas</i>	581	3.3	Repairer	592
2.2.3	<i>Emergency water supply</i>	582	3.4	Spare-parts network	592
2.3	Management by type of water-supply system	583	3.5	Local authorities	593
2.3.1	<i>Springs and streams</i>	583	3.6	Launching a community management system	593
2.3.2	<i>Open wells</i>	583	3.6.1	<i>Water management in the assessment phase</i>	593
2.3.3	<i>Handpumps</i>	583	3.6.2	<i>Establishment of the management system and agreements with the communities</i>	594
2.3.4	<i>Wind pumps</i>	584	3.6.3	<i>Establishment and election of the water committee</i>	594
2.3.5	<i>Motorised electrical pumps</i>	584	3.6.4	<i>Community participation during construction</i>	594
2.3.6	<i>Solar-powered pumping systems</i>	585	3.6.5	<i>Committee training</i>	595
2.3.7	<i>Rainwater harvesting</i>	585	3.6.6	<i>Handover of water supplies</i>	595
2.3.8	<i>Surface reservoirs (ponds)</i>	585	3.6.7	<i>Monitoring and follow-up</i>	596
2.3.9	<i>Water-treatment and distribution systems</i>	586	3.7	Cost recovery	596
2.3.10	<i>Emergency situations</i>	587	3.7.1	<i>Principles of contribution</i>	596
<b>3</b>	<b>Community-based management</b>	587	3.7.2	<i>Collection systems</i>	598
3.1	How does it work	588	3.7.3	<i>User-fee estimation</i>	598
3.2	Water committee	589			
3.2.1	<i>Functions of the water committee</i>	589			

Water-supply management includes all the activities aimed at ensuring the sustainability, the correct use and the rational exploitation of water resources and water-supply installations. It also includes actions to ensure equal access for all the population to the water supply.

The long-term resolution of problems related to access to water will largely depend on the way the water resource and installation are managed. Deficiencies in this management are responsible for damage to the environment, contamination and overexploitation of aquifers, low food production, failure in existing water and sanitation systems, poor sanitary conditions and inequities in access to water within communities. These problems are a consequence of stalled development and inappropriate water use and demand.

Water management concerns not only drinking and domestic water, but also water for irrigation, animals and industry. These uses require higher quantities of water than domestic consumption. Agriculture takes approximately 70% of the water used in the world, and many irrigation techniques involve substantial losses (up to 60%) because they are not appropriate or because they are poorly managed.

In general, water availability and quality can be ensured through:

- Rational exploitation of the water resources. The conservation of these resources should guarantee sustainable use.
- A comprehensive strategy for the development of water demand in relation to water availability.
- Good operation and maintenance of facilities in order to optimise the water supply (many urban systems have losses of up to 30% of the water supplied) and preserve water quality.
- Control of consumption to avoid wasting water.
- Improving irrigation techniques and systems, as well as selecting environmentally appropriate crops to reduce water consumption significantly.

Appropriate management involves the integration of both water and sanitation components.

Wastewater is an extension of the water-supply system, and excreta disposal, refuse management, drainage and other sanitation activities are also a major concern because they have an important influence on water sources and supplies, and they are complementary in their objectives to reduce health risks.

The causes of poor water-supply management include lack of capacity and knowledge, poor organisation, and absence of the habits and willingness required for appropriate management. Therefore, a big part of the solution must involve social aspects, developing awareness, training and organisation.

This chapter will focus mainly on the scale of the community, and it is concerned with the management of water and sanitation systems rather than the management of water resources, prioritising the importance of an equitable supply, the proper use of facilities and the sustainability of systems. Communities must be integrally involved in the management of their resources, and this implies their participation in all the management mechanisms.

## 1 General objectives

The key to good water-supply management is the choice of appropriate technology. It is essential that the technology is selected to match the needs, capacities and desires of the community. The ability of the community to understand, operate and pay for maintenance is essential to the sustainability of the system. In many cases, low-cost solutions and existing local technologies will be the best option. The initial cost of the system is an important factor for consideration as well, because it is often directly related to operation and maintenance costs. Many projects fail because the technology used is not appropriate to the capacities and needs of the communities.

There is no standard model for the management of water systems. There are many different contexts, each with specific factors to consider: characteristics of the resource, technology of the water system; needs, demands and development level of the community; community organisation; social and political mechanisms; level of involvement of the people; technical capacities; availability of equipment and materials; willingness to pay and to participate in management; community versus private approaches; and others. Defining and setting up a management system requires a full assessment of the situation. Integral to that assessment is the participation of communities from the beginning of the process. This chapter presents recommendations and key elements to take into consideration when establishing a water-management system.

During a crisis, problems are not only related to the lack of facilities but also to a loss of social organisation and capacities. The organisation of the communities to manage their water systems can also have an impact in the recovery of the community, helping the strengthening of social ties.

Water and sanitation projects must promote active management by the community. When determining an appropriate management regime, it is necessary to undertake the following steps:

- Analyse the available water resources and determine appropriate exploitation.
- Determine what is a sustainable water system, including an appropriate level of maintenance.

- Guarantee enough quantity and proper quality of water, with equal access for every member of the community.
  - Ensure access to water for vulnerable populations.
  - Establish a cost-recovery system to ensure consumers can pay for operation and maintenance.
  - Promote proper use and handling of water (integration in hygiene-promotion programmes, see Chapter 15)
  - Promote safety in relation to the construction and use of the facilities.
  - Put mechanisms in place to sensitise communities through appropriate management and to promote participation.
  - Use methods to empower women to participate in the design and construction of the water supply as well as the management scheme.
  - Integrate regional and national water policies: those policies should promote the active role of the communities in water management, providing the tools and proper methodologies to do it. Systems must also be designed following those policies, and advocacy should be done to encourage better policies that take communities into consideration.
- ACF advocates for universal access to water as an important element in the fight against hunger.

## 2 Types of management

Various management schemes exist and must be adapted to each specific context that is characterised by a certain set of needs and factors. Table 16.1 shows how different factors should be taken into account when designing the key elements of a water-supply management system.

### 2.1 Actors in charge of water-supply management

Management of the water resource and provision of water supply are two different tasks, each involving specific requirements and responsibilities. Both areas of management must be established and regulated according to the laws of the country.

Water-resource management should be under the control of governments and communities. In cases where water resources are shared between different communities, it will be necessary to have a clear agreement between them (sometimes this involves different countries), and procedures and rules must be established in order to have fair distribution and avoid possible conflicts.

There are three main actors who may be in charge of the management of water-supply provision: the private sector, the public sector and civil society – which can be the community itself and/or NGOs. (NGOs and other organisations can participate in this process but normally they will not be in charge of the direct management of the water supply in the long term.) In some cases there is joint

**Table 16.1: Factors for consideration when designing a water-supply management system.**

Issue	Factors	Key elements in the management
Water-supply system	Type of water supply (technology used) Size of water system	Operation and maintenance requirements Cost
Community	Number of users Social structure and local organisation Existing capacities Coping mechanisms, economic situation	Water-point managers Distribution of tasks Cost-recovery system Relationships between actors
Context	Emergency requirements Role of public administration	



management of water services, through a steering committee that includes private companies, public structures and community representatives.

This chapter will not enter in depth into the debate about public versus private services (see Box 16.1). Each situation requires specific analysis to define the appropriate management system. However, it is important to remember that the aim of a water-supply project is to ensure equitable and sustainable water access for all the community. At all times, the existing management mechanisms must be analysed and considered in the light of this aim.

Community management is a good solution for small-scale systems and it is probably the most appropriate (or common) system in many humanitarian and development contexts. In areas with community-managed systems, operations must be determined and accepted by the beneficiaries in order

#### Box 16.1

##### Private and public management.

Private versus public management is an important issue for many organisations working in water and advocacy, and it is mainly related to urban water supply and the involvement of water companies. There are several levels of discussion that are important to clarify:

- Provision of safe water normally involves costs, and so water consumption requires some form of payment, whether for private or public services. Payment for private services includes a provision for profit.
- Private management only concerns 10% of the water supply for the world as a whole, and between 2 and 5% in the developing countries. Globally, this is not the most important issue in relation to water-supply problems:
  - Rural areas are not normally concerned by this issue.
  - Privatisation is not generally an issue for the availability of water used for agriculture, which is the main consumer of water.
  - Health problems related to water and sanitation are not only related to who manages the supply, but are affected by many other factors, such as hygiene etc.
  - Much funding is provided to support the privatisation process, excluding other possible solutions that maybe more appropriate in contexts with major needs. On the other hand, advocacy against privatisation is the main issue for discussion in many forums and diverts activists from work on other important matters.
- Many organisations criticise the strategy of big donors such as the World Bank and the International Monetary Fund, that strongly support private management instead of providing more support to the public sector and the development of water policies.
- There have been some big cases of corruption concerning water companies, but corruption does not only concern the private sector. Discussion regarding privatisation at this point is concerned more with actual practice than the efficiency of privatisation models as such, or general assumptions regarding rights. The water companies involved in these cases have an important responsibility even when they do nothing strictly illegal.
- There are divisions of opinions regarding the greater efficiency of private management compared with public management (if the appropriate investment is made). A key difference is that private companies can normally provide the substantial investment that is required for some situations. Efficiency is more related to the existence of competition and options for choice, whereas monopolies appear to be less efficient, though both public and private structures may be monopolies.
- There should be a clear policy in each country to regulate how public and private structures operate. This policy must guarantee that service providers ensure equitable access, with special policies for poor and vulnerable groups, and that they limit environmental impacts. Even in the absence of legal or contractual obligations in this field (which is common in many countries where legal frameworks and/or regulatory capacity are not strong), companies should be encouraged to act ethically in the areas of environmental protection and social responsibility, rather than to take advantage of regulatory freedom to increase profits.



to reduce the risk of possible conflicts and misunderstandings. This type of management is broadly developed in Section 3.

ACF programmes normally support community or public management, but there are also experiences where private water-point owners are supported. Activities are focused on the strengthening of local organisational structures through the provision of resources and the training of personnel. It is important to involve the communities in the management, including vulnerable groups.

The main conclusion is that water-management mechanisms must be regulated by a clear and effective policy which ensures that systems are efficient and that the needs of the public are met. Organisations working with vulnerable communities should contribute to the development of these policies in order for those communities' concerns to be reflected.

In developing countries, large corporations tend to be interested in large cities, and their involvement can range from the construction of infrastructure to contracted management of the water system. These international companies often create local subsidiaries or partnerships with local companies.

Systems managed by private companies do not necessarily mean higher prices for water. Some experiences show that the poor generally pay more for water from the informal sector (water sellers etc.) than they do when they have a formal system. Prices must be regulated by the local authorities and must be covered by a clear policy.

Private companies that make big investments in the water-supply systems of many cities may negotiate long-term contracts for supplying water (up to 20 years in some cases). This is not a good option because if the management is not well done or if it is not the most appropriate arrangement, it is complicated to change.

Private management also varies from large water companies to private owners for individual water points. Regarding *individual private water points*, in many cases the owner of a water point (well, borehole or a connection to a distribution system) delivers water to other people in the community. The owner may obtain direct profits from delivering the water and normally has an incentive to maintain the water point.

It can be appropriate for projects to support the improvement of privately-operated water points when community access is guaranteed and there is no discrimination. Establishing rules with the owners, the community and the authorities is recommended: topics to address include the price of the water and how the price is negotiated, and the promotion of equitable access.

Equitable access can require special arrangements for vulnerable populations (cheaper rates or reduced rates in exchange for labour for example) and for public places (supplying a certain quantity of water free to schools and hospitals). One argument for convincing the owners to provide these arrangements is to explain that the improvements in their systems will increase water sales and consequently their profits.

Water-supply systems can also be managed by a regional body or local government. Some experience shows low effectiveness of those systems due to the risk of corruption and lack of skills. Often decisions are made politically. Interests can change when governments change, and people may be employed because of nepotism rather than skill. Consequently, maintenance can be poor, which compromises the sustainability of the system.

Again, the existence of a policy to avoid these problems and placing the responsibility for certain duties in professional hands, rather than depending on politicians, is the key to improving management.

In conclusion, there are several experiences (with public or private management) where vulnerable areas are marginalized and receive either a poor quality service or no service at all. This can be due to a lack of capacities or an absence of political interest and, in the case of the private companies, a perception of a high risk of non-payment. The authorities have a responsibility for developing pro-vulnerable water-supply policies. Another problem is the absence of participation of the communities in management, which can create inequities and social conflicts as experience has shown.

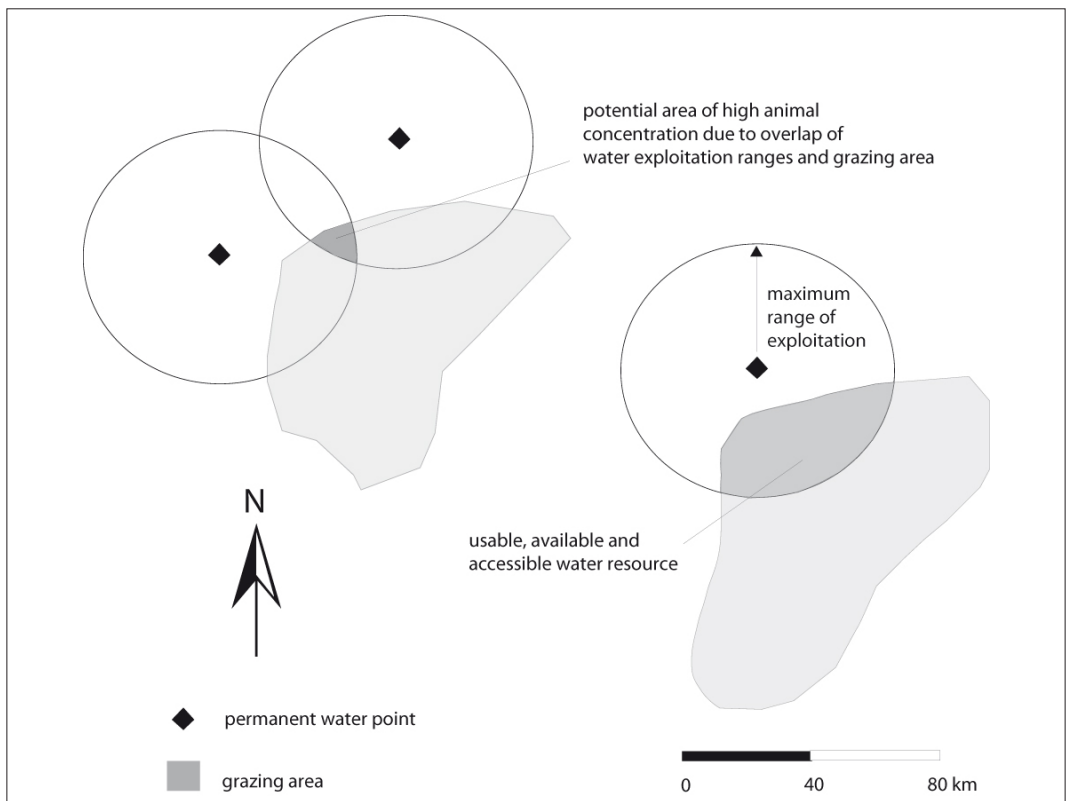
- Every system (private, public or community-based) should guarantee the following:
- transparency in management (all the information must be available to everyone);
  - active participation of the community in management;
  - access to water for all, and especially for the most vulnerable (taking into consideration affordable prices for all);
  - proper use of the system (maintenance and improvements guaranteed);
  - sustainability of the system;
  - protection of the environment.

## 2.2 Context and management

### 2.2.1 RURAL AREAS AND ISOLATED AND DISPERSED COMMUNITIES

Isolated areas are often ignored by governments and can be extremely vulnerable. Advocacy is an important part of project implementation and should aim to ensure that the needs of marginalized populations are heard and taken into account by decision makers.

Small isolated communities need low-cost solutions that can be managed with a minimum of outside support. Access to spare parts and consumables can be a major concern and skilled people are often difficult to find. Training the community in the management of water-supply systems and choosing a technology that ensures that operation and maintenance are appropriate to the human and financial resources available are essential for guaranteeing sustainability. The specific case of pastoral communities is illustrated by Figure 16.1 and explained in Box 16.2.



**Figure 16.1: Management in nomadic and pastoral contexts.**

## Box 16.2

### Management in nomadic and pastoral contexts.

People with a traditional nomadic lifestyle and can be affected by conflict or climatic changes in unique ways. Water points for nomads and pastoralists are often characterised by temporary use, with adequate water quantity for animals and people, rather than quality, as the main objective. The survival of nomadic communities depends on their ability to provide for their animals' basic water and pasture needs.

Any technology chosen must guarantee the provision of water. If a system fails it can put the whole community in danger. Experience shows that traditional systems are the best option because they require only very basic maintenance and there is no need for spare parts or consumables. Water committees and a cost-recovery system can easily fail, so the main guarantee of sustainability is the quality of construction of the water points.

The most common types of water point are:

- Open wells or combined wells (see Chapters 8A and 8D) where the water is drawn by traditional means such as pulleys, animal traction, or a shaduf. Training must focus on well cleaning.
- Ponds (in some places called birkads). Training must focus on drainage area and pond maintenance (see Chapter 19).
- Surface water.

The management of water can be complicated and must be adapted to the existing social mechanisms (nomadic habits, division of areas by social groups etc.). Water management also involves the location of the water points. When locating new water points, social aspects need to be considered in order to prevent conflicts between different pastoral clans or between pastoralists and cultivators. Local laws concerning access to water points such as grazing rights and rights of way, especially for livestock in cultivated areas, must be analysed before any water supply is constructed. In Afar, Ethiopia, when wells or boreholes, which are considered both as water points and private assets, are constructed in public grazing land, this land becomes private, thus overriding previous rules and traditional regulations.

Conflicts and changes in rainfall affect traditional nomadic routes, and new water points can be required. New systems must be planned and designed taking into account many factors: the existence of water resource, pasture, possibilities of conflicts. When a new water point is constructed, often nomads bring more animals to the area and create a situation where there is potential for an increase of animal diseases and overgrazing. In Mali, ACF's programme used satellite images and geographical information systems (GIS), as decision-making tools to locate wells while minimising overgrazing. Figure 16.1 shows an example of GIS analysis.

In sparsely populated areas, where the sense of community may not be strong, a household approach can be the best option (family water points, household water-treatment, hygiene promotion).

The most common solution in rural areas is freestanding individual water points such as open wells or handpumps or small-scale water piped systems. It is important to consider relevant national and regional policies in order to choose the right technology and to define the appropriate management arrangements (make-up of committees etc.). Low-cost technology and construction with local materials are a good ways to improve sustainability.

### 2.2.2 URBAN AND PERI-URBAN AREAS

Rural-to-urban migration is an increasing problem, with 50% of the world's population currently living in cities. Urban populations are increasing as people continue to move to cities in search of better economic opportunity or security, in the case of conflict situations. More vulnerable people concentrate in low-income suburbs where there are poor living conditions. Cities are 'melting pots' where various social, cultural, ethnic and religious groups come together. As living conditions can be difficult, tensions may arise. This factor must be a strong consideration when choosing the location of water points and deciding on management arrangements, in order to avoid conflicts or impeded access to water.

Piped water systems are most common in cities. Due to the size and complexity of the systems, management is normally the responsibility of the municipality. In some cases, the municipality contracts the responsibility to a private company. Though not common, it is beneficial if the community has a formal role in the management of the system. NGOs can advocate for this. Ensuring that the community has a voice in decision making is likely to ensure a better understanding of the needs of the poor by senior management.

Of primary concern are the poor and marginal areas of large cities, including peri-urban areas. Water services often do not reach these areas for a variety of reasons, including lack of political will, unresolved land tenure issues and lack of financial resources to extend water-distribution networks. Furthermore, peri-urban areas often lie outside the area of the municipality's responsibility. These areas are often densely populated and lack adequate sanitary infrastructure. Combined with lack of water, these three factors create a high public health risk. When people do not have access to the formal water-supply network, they obtain water from a variety of informal private sources, such as from private wells (e.g. in Monrovia, Beira, Kabul or Mogadishu), or buy water from water vendors who supply water using water trucks, donkey carts etc. The water quality is usually poor and prices are high and represent an important amount for many families (mainly during periods of scarcity, when prices increase). An option for short-term intervention can be to improve water quality by working with vendors. In Khartoum, ACF introduced washing areas for donkey carts in some peri-urban districts and made some improvements to the carts. ACF is also involved in negotiations with vendors to have agreements on the price of water and on the management of the supply. However, ensuring the quality of those systems is difficult in the long term and prices remain high for many people. Marginally improving small-scale provider service will not resolve the larger problems of unequal access to a municipal system that should be providing water to the entire population.

### 2.2.2 EMERGENCY WATER SUPPLY

Natural or man-made disasters cause loss of life and economic opportunity, and increase the vulnerability of the poor. Both water infrastructure and a community's social structure can be damaged or destroyed, affecting water management badly. Displaced populations can create refugee camps and informal, unserved temporary settlements. As a consequence, people's most essential needs may be not be met and emergency response is required.

Emergency response must be rapid and effective. The population concerned must be involved in the management of emergency water provision (see Section 2.3.10), though in displacement emergencies, external support is necessary. People's social networks and support systems are disrupted along with their sources of income and food. Setting up independent water committees in situations like this may not be the most appropriate solution. Beneficiary participation should be promoted to the extent possible; however, it is important to understand that in some cases, particularly in the first moments of a crisis, it is very possible that people are not prepared, either physically or psychologically, to be involved in any activity beyond their own personal survival.

When participation is possible, affected people can be involved in general camp management in the case of refugee or displaced-people's camps, through the creation of Water and Sanitation Committees. These committees can be used to develop management arrangements, in the post-emergency phase, when the response requires more self-sufficient solutions. All actions should be coordinated with the local authorities, even if they are overwhelmed and able to contribute little.

When the emergency response is focused on the rehabilitation of the existing infrastructure, the best option for management is to reinforce the existing system through the involvement of the personnel normally responsible. Careful attention must be paid to the type of external assistance provided, because a surplus can lead to a dependency that will have negative effects in later phases.

## 2.3 Management by type of water-supply system

Not all water-supply systems require the same level of management. A handpump does not have the same management requirements as a large urban water-supply system. Daily operations, maintenance and service inputs are completely different and need a different organisational structure and resources.

Quality construction is always a first step to sustainability and it is essential, particularly in cases where the community cannot ensure proper operation and maintenance.

Management organisations need to be adapted to the type of water-supply system and technologies. Examples are presented below.

### 2.3.1 SPRINGS AND STREAMS

Springs can be captured and protected at the source, and the water collected in a small tank and distributed through a tap. Alternatively, several surface-water sources are collectively channelled to small gravity-fed networks.

Routine operations do not require consumable materials and often do not require a regular operator. Maintenance depends on the quality of the construction and the exposure to natural or human hazards. Protection of the natural environment surrounding the water source is key to maintain its yield. Deforestation of the immediate area can lead to erosion, which causes a loss of soil and this can cause deterioration of the constructed catchment.

- Management tasks: the main issue is protection of the water source against erosion and contamination, through regular cleaning and preservation of the vegetation in the catchment area. Basic repair of the structures built will be needed, but not on a regular basis.
- Cost-recovery: routine operations do not necessarily incur cost. Often, cleaning and basic repairs can be performed through voluntary community work.
- Actors involved in management and training: few people are required for operating and maintaining a water supply: even one can be adequate. Training should focus on cleanliness and protection of the water source.

### 2.3.2 OPEN WELLS

- Operation and maintenance requirements are low. Operation does not require consumables, and repairs can be done mainly with local materials.
- Management tasks: the main concern is keeping the water clean and using the well properly. Maintaining the water-drawing system (ropes, pulleys etc.) is a primary task. Also, periodic disinfection is necessary to maintain clean water and this can be organised by the community. Eventually, basic repairs of the construction will be needed.
- Cost-recovery: daily operations do not incur costs unless someone is paid to draw the water. Cleanliness and basic repairs can be ensured through voluntary community work and do not require a regular payment system.
- Actors involved in management and training: direct management will not require many people and even one may be adequate. Training should focus on well cleanliness and protection of the water.

### 2.3.3 HANDPUMPS

– Operation inputs are low as there is no need for consumables and, depending on the pumps, maintenance should require low to medium attention. Low-cost handpumps are relatively easy to repair and the cost per repair is low, though they may need more frequent repairs. Repairing pumps can require specific skills, tools and spare parts. It is important to be sure that spare parts are available. If a standard type of pump exists in the region, it is best to choose this technology as spare parts and trained technicians are more likely to be available.

- Management tasks: the main issues are to ensure that the handpump is correctly used and greased to ensure proper function; to maintain and clean the surface protection and the drainage; and to prevent and repair any breakdowns by replacing worn or broken pump parts. Basic repairs of the well itself or the surface protection may also be needed, but not on a regular basis. The well or the borehole will also require cleaning.
- Cost-recovery: operations will have a cost if a person is responsible for drawing the water. The community can pay for the cost of the spare parts and repairs either by having regular payments (by quantity of water used or through monthly fees) or by raising funds when a problem occurs. There are regular maintenance costs as parts will require regular replacement. It is advisable that the community or the owner of the pump has the means to buy a new pump when it is necessary to replace it. Pumps range in cost from 100 euros to 3 000 euros. There is also a considerable range in the cost of spare parts, depending on the type of pump.
- Actors involved in management and training:
  - caretaker (private, or someone chosen by the government or community): training focused on proper use, basic maintenance and cost recovery;
  - repair and maintenance personnel (i.e. handpump mechanics): training on maintenance and repair. Agreements with communities for costs;
  - spare-parts suppliers: ensuring the availability of spare parts and regulation of prices (in agreement with communities and pump mechanics). Providing information on prices.

### 2.3.4 WIND PUMPS

Management requirements are similar to handpumps and they do not require operators. Maintenance and repair can be a little more difficult than handpumps and depend on the local wind patterns. If these are not stable then the wind-pump mechanism can suffer more wear and possibly damage, and requires more maintenance. Wind may not be adequate during parts of the year, which can interrupt water supply. This can lead to a loss of interest from the community in maintaining this system. The price range, depending on the models, is generally higher than for handpumps.

### 2.3.5 MOTORISED / ELECTRICAL PUMPS

- Operations require skilled personnel and consumables such as electricity or fuel. Maintenance requires mechanical and electrical skills and a qualified person must be responsible for the repairs. Spare parts may not be easily available and this factor should be considered when choosing pumping equipment.
- Management tasks:
  - control the operating hours per day (how many hours depends on the system) in order to prevent the pump and generator from overheating and to avoid over-abstraction of water;
  - ensure the electrical system is working properly;
  - manage consumables (purchase, storage and proper use) and periodic maintenance (oils, filters etc.);
  - manage the payment system;
  - repair damages.
- Cost-recovery: the system is best based on regular payment (per quantity of water, per connection or on a periodic basis). The total cost must include operation and maintenance. See Section 3.7.
- Actors involved in management and training:
  - private owner or committee: general management, training focused on cost recovery;
  - caretaker: training focused on operation and basic maintenance;
  - mechanics: training in mechanical and electrical repairs;
  - spares suppliers.

### 2.3.6 SOLAR-POWERED PUMPING SYSTEMS

- Operation is automatic and does not require consumables. Most maintenance tasks are simple, but some repairs will require a high degree of expertise. A specialised company must be operating in the area to guarantee repairs. The pump will require the same maintenance as a normal motorised system.
- Management tasks:
  - keep the solar panels and system safe and clean;
  - ensure the electrical system is working properly;
  - manage the payment system. Because the system does not need consumables people may be reluctant to pay on regular basis;
  - repair damages, generally by using a specialised company.
- Cost-recovery: it is recommended that the system is based on regular payments (per quantity of water, per connection or on a periodic basis) because repairs can have a significant cost. Promotion of this type of payment system is important as people are not aware of potential costs since there are no regular consumable purchases. Cost-recovery can be difficult for a solar system because it appears to run at low cost. However, the cost of occasional repairs, along with regular operations-personnel salaries and depreciation add up and cannot usually be raised in a short period of time.
- Actors involved in management and training:
  - private owner or committee for general management and cost recovery;
  - caretaker: training in operation and basic maintenance;
  - company or specialised organisation in charge of repairs.

### 2.3.7 RAINWATER HARVESTING

- Rainwater harvesting systems capture rain from building roofs and other catchment areas. They are often installed at the building level, collecting water from houses or public buildings such as schools or hospitals. It is difficult to maintain the quality of rainwater, so it is often used for other purposes when there is a suitable alternative supply of drinking water.
- Operations do not require consumables and maintenance, and can be done mainly with local materials.
- Management tasks: the main concern is keeping the water clean by ensuring the cleanliness of the roof, gutters and tank. Also, it is important to use the system properly. In some cases a pre-treatment can be installed in the form of a small sedimentation tank or sand filter. This addition requires special attention for maintenance. Basic repairs on the roof, gutter, tank and taps will be needed, but not on a regular basis.
- Cost-recovery: operations do not incur costs, and maintenance costs are low if the system is well constructed.
- Management responsibility: mainly private owners or staff in the institutions (schools, hospitals etc.).

### 2.3.8 SURFACE RESERVOIRS (PONDS)

There are two primary situations where the creation of surface reservoirs is appropriate. The first is in dry areas with short and heavy rainfalls. Ponds can be constructed to collect runoff and are used only during a period of the year. These types of runoff-collection ponds are common in pastoral contexts and are used mainly for livestock. The second situation is in high-rainfall areas where ponds collect rainwater directly, without runoff (they function as an impluvium). These systems are a valuable water resource where springs and other groundwater sources are scarce. See Chapter 19.

- Operation and maintenance is not complicated but require a high level of community involvement in order to maintain the runoff system (where present) and ponds, avoid losses and



ensure protection from major contamination. For runoff systems, water quality is difficult to ensure. Efforts are more focused on ensuring quantity of water through dryer times.

– Management tasks:

- maintenance of the runoff system, fences and other protections to keep animals away from the ponds;
- cleanliness and repair of the pond; in some cases covering with branches to reduce evaporation;
- maintenance of the water-drawing systems, such as channels or access jetties, or pumps in some cases; maintenance of filtration trenches.

– Cost-recovery: cleanliness and basic repairs can be carried out through voluntary community work, and provision of tools may be required. Large pond repairs can be expensive if machinery or a large amount of cement is needed. Except in private systems, periodic payment is complicated and a cost-recovery system will be difficult. As high-cost repairs are difficult for the community to cover, it is important to ensure periodic community-led maintenance

– Management responsibility: whether a private or community supply, labour is needed for maintenance.

### 2.3.9 WATER-TREATMENT AND DISTRIBUTION SYSTEMS

– A water-treatment and distribution system requires joint management of all its component parts including the catchment system (borehole, spring, river etc.), pumping system (if it exists), treatment, storage, pipelines and distribution points. The system is more complex than an individual water point and therefore requires a higher degree of management. The complexity of management and the skills required depend on the size of the system and the choice of technology.

– It is necessary to define operations, maintenance and cost-recovery policies clearly. Participation of representatives from the community is required, to have an equitable supply.

– If a sewerage system also exists, management should be co-ordinated with the water supply.

– Before planning the design of a water-supply system which will serve different communities, where there is a risk of conflict between them over the management of the supply (there are several examples of one community sabotaging the system to prevent water reaching another community) it is better to build separate systems or take measures to reduce risk (different pipelines in some places etc.).

– The main tasks are:

- control of all the actors involved in the management and use of the system, especially re the supply (hours and quantity);
- treatment of water (if needed): consumables, process, maintenance;
- maintenance and repair of the supply system: construction works and plumbing, leakage control;
- water-quality control;
- payment system (contributions);
- co-ordination of the different actors and involvement of the community in managing the system.

– Cost-recovery: the total costs recovered must include all operations and maintenance expenses. See Section 3.7.

– Management roles:

- operation and maintenance staff, normally contracted, receiving a salary on a monthly basis;
- fee-collection staff;
- management committee, with representatives of the community, public authorities and, in some cases, private companies. If the system is small, some of the committee members can also carry out the maintenance;
- spares suppliers.



### 2.3.10 EMERGENCY SITUATIONS

The first priority in emergencies is to guarantee a minimum quantity of safe water. Common techniques used in emergencies are water treatment (see Chapter 12) and water trucking (see Chapter 17B). Both activities require significant organisation and specific emergency materials and equipment for treatment and distribution.

#### *Emergency water-supply systems*

- Operation and maintenance of the emergency water supply: motor pumps, flexible hoses, transportable tanks etc. (for more details on emergency equipment, see Chapter 17).
- Water treatment and water-quality control: if required, flocculation and chlorination procedures, water-quality monitoring (turbidity, residual aluminium, if aluminium sulphate is used, and residual chlorine).
- Monitor consumption and ensure equitable distribution. This is necessary and can be difficult due to the scarcity of safe water. Awareness among users is a starting point, but conflicts within the community (or between communities) can occur. Measures can be taken to avoid these problems, such as installing water-saving taps (such as Talbot taps) to reduce losses, and controlling the quantity supplied to each family with methods such as distributing tickets or registering containers.

#### *Water trucking*

- Bringing water to a population by trucks requires a great deal of organisation. The water should be delivered to water tanks at central points, rather than directly to people. Delivery must avoid direct distribution, and instead focus on transporting water to central points.
- Water distribution is done at specially constructed points, such as a tank with tapstands. Water is chlorinated and its quality is monitored. The community should be involved in the preparation and installation of the systems, including activities such as making the platform for the tank, surface preparation for the tapstand and controlling the supply. A committee can be set up within the community to be responsible for the chlorination of the water (one or two people in charge) and distributing it (one or two people).
- General management of the system: primary actors include the water-truck operator, communities, and authorities. Main tasks are:
  - informing the community and other actors of the planned system, and obtaining agreements;
  - organising transport, including the creation of a movement schedule for the trucks, overseeing payments for the drivers, renting the trucks, cleaning truck tanks, and ensuring maintenance of the trucks;
  - setting up a committee responsible for the emergency distribution points, to involve the community in construction, control of the supply, chlorination (training may be required) and water-quality monitoring (residual free chlorine). If involvement of the community is difficult, salaries may need to be paid;
  - authorities must be involved in supervision of the system.

## 3 Community-based management

Community participation is important in any management system. However, in the case of small-scale water supply systems it is the main priority, particularly in rural and peri-urban areas of developing countries and vulnerable zones affected by conflicts or disasters.

When public authorities do not have the capacity to manage a water-supply system, community-managed infrastructure is the best option for ensuring sustainability.

### 3.1 How does it work

In community-based management, the community is responsible for the water system. Water management requires that adequate technical skills, labour and funds are available within the community. Figure 16.2 illustrates the different actors involved and the relationships between them.

There must be clear policies and rules defining the roles of all actors involved and guaranteeing all necessary inputs required to sustain the system:

- The water committee is a group of people elected by the community, and is responsible for the direct management of the system (cleaning, maintenance, minor repairs, operation etc.) and the collection of funds for operation and maintenance. The relationship between the committee and the rest of the community has to be clear and transparent. The committee organises and mobilises people to collaborate, contribute and respect the rules for correct use of the water system.
- Water committees are responsible for hiring technicians and other professionals to repair the system in the case of a breakdown in service. Prices and rules must be agreed between water committees and mechanics and depend on the type of labour needed. Programmes are focused on mechanic selection, training and strengthening of their capacities.
- Spare-parts availability should be guaranteed through local structures or local retailers. Market access and supply must also be arranged involving the water committees.
- Local authorities should play a supervisory role in supporting the system and be involved in the definition of rules. It is useful if they encourage the establishment of new organisations or businesses if these are necessary (i.e. water committees, mechanics or spare-parts retailers). Water committees should be recognised by local authorities and establish a solid working relationship. Local authorities can be a training resource for water committees and should take an active role in ensuring they continue to function. This role can initially be played by the implementing agency but it must be handed over to the local authorities at the end of the programme.

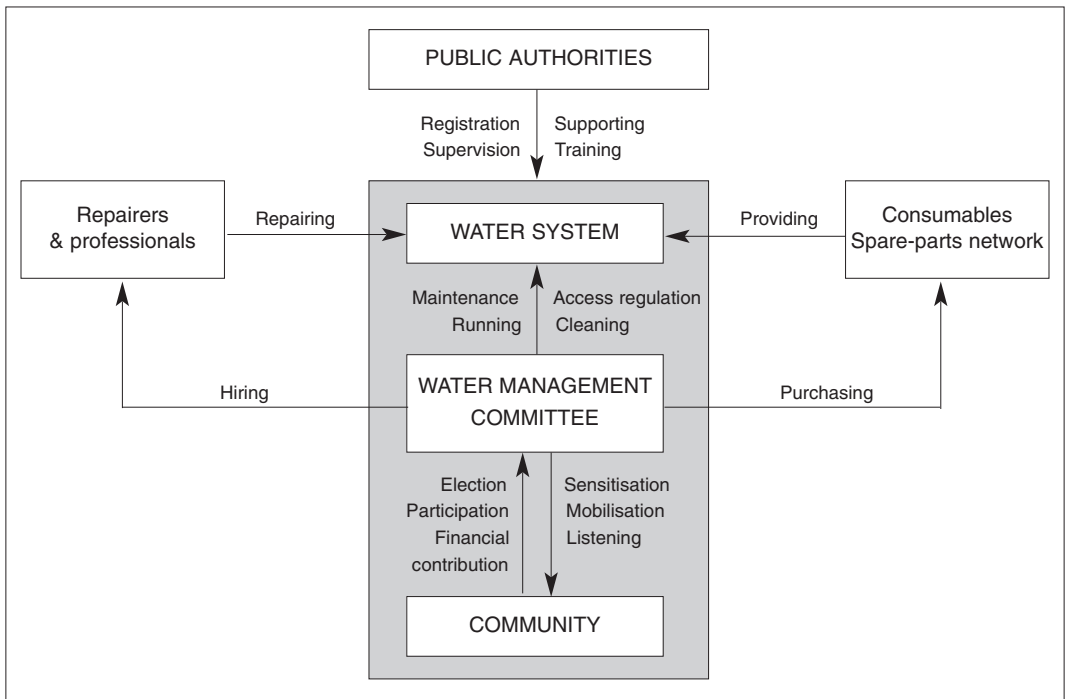


Figure 16.2: The actors and activities of a community-managed water supply.

## 3.2 Water committee

The water committee is the group of people chosen by and from the water-supply users, and will act on their behalf to organise the management of the water service in a community.

There are no fixed rules about how the committee is organised, how many people must sit on it and other such basics. The committee has to be designed in an appropriate way for each specific context and within existing structures (sometimes a water committee already exists when a project starts). Nevertheless, the model below has been used as the basis for water-committee design in many communities involved in ACF programmes.

### 3.2.1 FUNCTIONS OF THE WATER COMMITTEE

The main tasks of a water committee are:

- Guaranteeing equitable access to the water supply for the entire population.
- Collection of fees from the users and transparent use of funds.
- Daily maintenance (purchase of consumables, turning on/of the pump, opening/closure of valves, chlorination etc.) and repairing of the system in the event of simple breakdowns.
- Organising the cleaning of the water system and its environs by the community of users.
- Purchase of spare parts or tools if necessary.
- Hiring professionals to repair the system in the event of a complex breakdown.
- Training the community to encourage the correct use of the water supply and safe hygiene behaviours.
- Co-ordination with, and reporting to, local authorities and appropriate agencies.

These tasks should be carried out following a few basic rules:

- All members must be volunteers, elected by the community.
- They must work for the general interest of the community.
- It is important to have sufficient representation of various interests on the committee, including meaningful representation of both women and men.
- The committee should report regularly to the rest of the community and the local authorities on their activities and finances.

### 3.2.2 COMMITTEE MEMBERS

#### 3.2.2.1 *President*

The president is the facilitator and co-ordinator of the group. Through their authority, they facilitate the decision-making process and are responsible that the committee functions. They also ensure the links between the different members of the water committee and organise regular meetings with the population.

A good president must be:

- motivated;
- able to read and write;
- available: it's preferably to live in the village in order to carry out the role;
- respected and trusted by the community.

The main functions are:

- to organise regular meetings with the other members of the committee in order to explain what has been done and also to discuss the problems encountered;
- to make decisions in consensus with the water-committee members;
- to mediate between the population and the other water stakeholders;
- to mobilise the population around the water system, sensitising people about the importance of good use and maintenance of the system;

- to assist the others members of the water committee in their tasks;
- to collect information about the community concerned;
- to regulate the use of water by following basic rules.

### 3.2.2.2 Technician

The technician is responsible for operation and maintenance of the water system. The population should assist the technician in carrying out the necessary activities.

As this role is completely technical, it will depend on the type of water supply constructed.

Table 16.II lists possible tasks for a technician maintaining a handpump and a small gravity-fed system.

**Table 16.II: Role of the technician.**

Gravity-fed distribution system	Handpump
Regular cleaning of the catchment and reservoirs	Regular servicing of pump: cylinder, piston, seals, rising main etc.
Valve management	Replacing worn-out parts of the pump
Servicing pipelines	Repairing simple breakdowns
Repairing leaks	Reporting the state of the pump to the other members of the committee
Installing new connections upon authorisation from the president	
Reporting the state of the system to the other members of the committee	

### 3.2.2.3 Treasurer

The treasurer is responsible for collecting user fees and managing the budget of the committee. It is a key position and it is important for the treasurer to work transparently in order to be trusted by the community.

The treasurer is responsible for:

- collection of the fees;
- administration of the accounts;
- purchase of materials needed for maintenance and operation;
- maintenance the accounts book;
- attending committee meetings.

In order to be able to fulfil these duties, the treasurer must know how to read, write and count without difficulty. They must also be organised, reliable and honest. It is better if the treasurer lives in the community and is thus available to community members. In some countries, this work is done better by women than men as they are viewed as more trustworthy holders of money.

The money, documents and books have to be kept in a safe place. It may be possible to open a bank account or have access to a safe location in the local administration in order to improve safety. It is safer to have a stock of spare parts than to hold cash.

#### *Fee collection*

To keep track of the payment of user fees, the treasurer should keep one record sheet per family with the name of the family, the number of people in the family and an entry for each monthly payment.

The treasurer should also create a balance book and start a new page each month, as shown in Table 16.III.

**Table 16.III: Example of an accounts book.**

Date	Type of operation	In	Out	Remaining	Signature
01/02/04	Balance at end of January			22 000	
05/02/04	Total monthly collection	6 000		28 000	
13/02/04	Purchase of a new piston		3 600	24 400	
20/02/04	Fence construction		1 200	23 200	
01/03/04	Balance at end of February			23 200	

At the end of the month, the accounts sheet must be closed and the amount of money remaining in the cashbox must be checked against the one written on the book – it should be identical.

ACF provides a book, calculator and office materials to the treasurers of the committees at the end of their training.

#### *Purchase control*

The decision to make a significant purchase must be taken among the members of the committee. The population should also be informed about these purchases. The committee should always keep a small reserve of cash, in order to be prepared for unforeseen problems.

A purchase must always be justified by a receipt. On this receipt must be written:

- date of purchase;
- detail of purchased items;
- amount of money spent;
- name and signature of seller and purchaser;
- the receipts are to be kept in a safe place and classified by chronological order.

Every water user has the right to view the expenses and check the accounts. The treasurer must report to the committee and the population each month regarding the accounts.

#### *Monthly report*

After having closed the monthly accounts, the treasurer must make a detailed report of expenses and income, and the money remaining in the cashbox. Table 16.IV shows an example from East Timor.

**Table 16.IV: Example of a monthly accounting report in Salau, a village in East Timor.**

Type of operation		July 2001
Balance at the end of June	+	5.00 \$
July taxes collected – 75 families	+	7.50 \$
July expenses		
– 1 tap for tapstand N°13	–	0.80 \$
– 1 wire brush	–	0.90 \$
Balance at the end of July	–	10.80 \$

#### *3.2.2.4 Hygiene promoter*

The hygiene promoter is responsible for the cleanliness of the water point and the surrounding environment, as well as providing education to the population on good hygiene and avoiding water-related diseases. The role is similar to the one described for the community hygiene facilitators in Chapter 15.

### 3.2.2.5 Reforestation person

In gravity-fed water systems, the conservation of the forest and vegetation around the spring is important for maintaining the yield of the water source. Therefore, it may be useful for the committee to include a person responsible for protecting the surrounding forest and to plant trees where deforestation is a problem. This person can be trained in forestry, agriculture and environmental issues.

## 3.3 Repairer

Repairers (plumbers, mechanics, masons etc.) can be trained in maintenance and equipped with tools and other resources (e.g. bicycles) to repair the system when the work required is beyond the capacity of the committee technician. These people will receive a payment for the work done. Fixed rates should be established for foreseeable tasks. These rates can also be used as a guide for unforeseeable tasks. The contract between the community and the repairer should be clear and accessible for all users. Box 16.1 contains the main points to consider for the selection and training of repairers.

The demand in the area covered by a repairer has to be large enough to make this job reliable.

### *Selection*

- Existing professionals who are interested in the job.
- Long-term residents in the area.
- Technical skills.
- The area is not covered by other repairers.
- Special attention must be paid to selecting women where possible.

### *Training*

- Spare-parts identification and system mechanics.
- Detection of problems and repairs.
- System maintenance.
- Contacts and contracts with water committees.
- Repair reports.
- Tools/spare parts management policy.

## 3.4 Spare-parts network

Supply of spare parts can be provided by the government or by NGOs, but this system is not sustainable in the long term. The most sustainable option is to involve local retailers who sell the parts to the water committees or repairers as needed. Local retailers will get involved if they see a possibility for profit so it is very important to create a real demand for spare parts for this system to work. The main concern of the vendors is the risk of losing money. Some programmes in Mozambique and Northern Uganda have supported this sector through a loan of spare parts on a 'sale-or-return' basis to minimise the vendors' risk until a more regular trade is established. Price of the parts must consider the item cost, the cost of transport and the profit for the sellers. Communities must be informed of where spare parts are available.

### *Training of spares suppliers*

- Spare parts identification.
- Stocking procedures and stock-record management (stock cards etc.).
- Unit prices and retail profits.
- Stock replenishment.

### 3.5 Local authorities

The local authorities are responsible for supporting the entire management system in the long term. If a NGO is playing this role for some time, then the local authorities must be involved from the beginning in order to be able to hand over these duties.

#### *Role of local authorities in community-based water management*

- Regulation and policy on community-based management.
- Co-ordination of different stakeholders (external agencies, private companies etc.).
- Mobilisation of communities and establishment of water committees. When local authorities do not have the capacity to do this, an external agency can play this role.
- Legal registration of the committee and the water system, as well as management of a data base with all the information concerning water infrastructure, communities etc.
- Monitoring and training of water committees.
- Monitoring and training of repairers. Supply and renewal of tools.
- Co-ordination between the principle actors: water committees, repairers and spares suppliers.
- Agreements on price rates for works and spares.
- Repairing major breakdowns: in some countries the government takes responsibility for repairing the water system if the cost of repair cannot be borne by the community.

### 3.6 Launching a community management system

Programmes must be focused on community organisation in order to set up a management system. The first step is the mobilisation of the community in order to define the management system. Communities must be involved from the beginning of the project (identification of needs) to the end (when they must manage independently).

#### 3.6.1 WATER MANAGEMENT IN THE ASSESSMENT PHASE

As mentioned in Chapter 15, the involvement of the community and the use of participatory techniques in the needs assessment is a key point for achieving sustainable systems. The following points should be considered in order to define an action plan for launching an effective water-supply management system:

- Priority needs and requests of the community.
- Social structure, who is currently managing the water resources, and who will be managing the new/rehabilitated system. Explore possible conflicts.
- Economic situation of the families (for example, their ability to pay the maintenance costs of the system).
- Existing payment structures and/or people's willingness to pay for water.
- Motivation and ability of the people to contribute labour or money to the construction, operation and maintenance of the water system.
- Current management of their existing water-supply structures.
- Existing groups whose activities are related to health, water and the environment (health workers, water committees etc.).
- Standard materials and equipment used for water supplies in the region (type of pumps, pipes etc.).
- Local availability of spare parts.
- Technical skills of the people: availability of personnel able to maintain and repair the water system or with the capacity to learn through training.

A participatory baseline survey enables the community's needs to be identified and prioritised. After this, a meeting is organised with community members. With the help of participatory rural

appraisal (PRA) tools, a discussion is carried out with the community about the problems identified (water availability, distance to a water source, primary diseases and their causes etc.) and possible solutions. At this point, some suggestions for solving these problems are made, with an explanation of how the community can be helped to reach the objectives set.

### 3.6.2 ESTABLISHMENT OF THE MANAGEMENT SYSTEM AND AGREEMENTS WITH THE COMMUNITIES

Once needs and capacities are identified, it is necessary to define the participation of the community in the implementation and management of the system. An agreement including the main rules and regulations is signed between ACF and the community. Local authorities witness all project agreements.

Next, ACF and the community discuss how the work will be carried out and how the system will be managed. The ACF model (as described above) can be suggested and adapted to the particular community. The community will develop their model, choose the committee members and set up the management system in relation to their needs and perspective.

Regular meetings with the community on the progress of the project will allow for easier identification of problems encountered during implementation and provide a co-operative structure to find the required solutions. The involvement of all the community members in the implementation process can instil a sense of ownership and is a primary factor in the sustainability of water-supply management.

### 3.6.3 ESTABLISHMENT AND ELECTION OF THE WATER COMMITTEE

During the initial meetings with the community, people generally voice a problem with water-point maintenance. The idea of a water-supply management committee is presented and discussed as a solution. The community then decides on a set of selection criteria that is used to help people elect trustworthy and hardworking people to the committee. The gender issue is also discussed as both women and men must be involved, considering women's major role in water collection and management. When all relevant issues are agreed upon, a date is set for the election of the committee.

Another concept that can be introduced is a system of periodic elections in order to guarantee the possibility of committee-member turnover. It is worth considering that sometimes the management system does not work because of certain people and not because of the system itself.

### 3.6.4 COMMUNITY PARTICIPATION DURING CONSTRUCTION

As the water-supply installation will belong to the users, they should contribute to construction by providing manpower and materials locally available or by paying for part of the implementation activities.

Through the committee and the head of the village (or some other appropriate leader), the community arranges the distribution of the work needed for construction. Some examples include:

- *Well digging*: this work is done by community members supervised by ACF technicians. In the agreement between ACF and the community, the head of the village commits to provide 2 to 4 people per day, usually men, for doing this work.
- *Drilling*: community members clear the way to the place chosen for the borehole, dig the settling pits and help to offload the materials from the truck. They do not participate directly in the drilling operation, which is managed by the ACF drilling team.
- *Pipe laying*: one of the heaviest tasks in the construction of a water-distribution system is the excavation of trenches for burying the pipe. The total length of pipe to be buried will be divided by the number of participants and they will dig the trenches. The installation of the pipes will be done by skilled plumbers (employed by ACF), often together with community members.



– *Masonry works*: some communities have masons able to construct water tanks, tapstands, aprons etc. The work of the mason is usually paid because of the volume of work and the skills required. However, assistance and materials, such as sand, gravel or water, are provided by the community. When the volume of work required per person is very high, the idea of cash or food-for-work can be considered.

In some cases, such as Indonesia, ACF just distributes the materials, works out the technical design and advises as the construction works are carried out by the communities.

As the implementation of the work can sometimes involve risks, community members should be aware of these risks, and safety has to be managed by the representatives of the community.

The community contribution can be also financial. For example, in Bolivia, a financial value is established for a day of manpower. After calculating the hours of work per person that are necessary to finish the construction, people can contribute with their work or with the equivalent amount of money or other resources. The money collected is used for paying the people working extra hours, for buying tools and organising activities, or can be kept for future expenses.

### 3.6.5 COMMITTEE TRAINING

In order to make the water-system management more sustainable it is important to train the committee members to carry out their functions appropriately. Participation in the construction phase also serves as a short technical training for the technical members of the water committee. Combined training courses for committees from several communities allow the sharing of different experiences and points of view, and also increases the status of the committee members.

The following list is an example of a four-day committee training course carried out by ACF in Moyo (Uganda).

- Introduction and opening remarks.
- Participants' expectations, fears and dislikes.
- Participants' concerns.
- Course objectives (broad and specific).
- Composition and roles of the water committee.
- Water (its importance, cycle, sources, uses, qualities of each source, contamination, simple purification methods).
- Water-related diseases, prevention, and control.
- The safe-water chain.
- Guidelines for keeping water source, and water from the source, clean.
- Environmental sanitation.
- Hygiene (personal, family, food, and community).
- Communication and mobilisation skills.
- Leadership skills.
- Co-operation and self-help.
- Water-fee management and proposed guidelines for water-supply sustainability.
- Community-based management system.
- Participants' action points and the way forward.

### 3.6.6 HANDOVER OF WATER SUPPLIES

It is recommended to organise an official event in which a handover document is signed by the implementing organisation, the members of the committee, the head of the community and a representative of the public authorities if possible (Water Department, Health Ministry or District Authority etc.).

This document should mention that the owner of the water-supply system is the community, which has responsibility for maintenance from the moment of signature on. Sometimes the handover

is preceded by a test or guarantee period during which the community uses the facilities, in order to ascertain that they are fully prepared.

It can also be positive to provide a set of tools (for cleaning, maintaining or repairing the water system) and spare parts to the committee to start their activities. These are handed over together with the water-supply system.

### 3.6.7 MONITORING AND FOLLOW-UP

This is one of the most important steps in a programme that aims to support the community management of a water-supply system. Regular visits and advice are usually required before the committee becomes a self-sufficient institution able to manage the water system independently.

Issues to be monitored by the field worker in a follow-up visit are:

- general state of cleanliness of the water-supply facilities and surroundings;
- if the water system is in good condition and working properly;
- quality of the water;
- accounting: money collected, expenses, money in reserve;
- breakdowns occurred and solutions implemented, parts replaced;
- frequency of system maintenance;
- stock of spare parts.

*Frequency of committee meetings.*

The most frequent reasons for community-based management failure are presented in Box 16.3.

Activities supporting the committees can be organised after the completion of the construction phase to reinforce either water-committee capacities or their motivation. In Uganda, competitions were organised between different committees, with points awarded for water-point condition, the stock of spare parts and other indicators of good management. The prize was a kit of cleaning tools, spare parts etc. These competitions promoted competence and gave the opportunity to share ideas among the participants.

In some villages in Guatemala, the water festival has become an important date that almost everybody celebrates. Plays and music related to water topics are prepared each year by villages and they compete in a festive environment.

## 3.7 Cost recovery

Cost recovery is one of the most difficult issues in a community-managed water system, as people are often not prepared to pay for water. As the users are responsible for the service, it is important that they pay the operations and maintenance costs. This must be discussed, understood and accepted by the users and outlined in the first agreement signed between the community and the implementing partner. Normally users periodically contribute an amount established by the whole community (yearly, monthly or at another agreed time interval – see Section 3.7.2). The person responsible for the collection is the committee treasurer, who maintains a complete and exact record of expenses and fees paid.

There are a few ways to promote fee payment at the beginning of a project. One is to offer a small amount of money to the committee, once they themselves have collected a certain amount, as an incentive.

A point to consider is that it is easier to establish a payment culture in systems that require consumables and regular maintenance than in systems where the results of the payment are not evident, such as systems with solar pumps or handpumps.

### 3.7.1 PRINCIPLES OF CONTRIBUTION

The total amount of money collected has to cover the operation and maintenance of the water system delivering the necessary quantity and quality of water for its users.

### Box 16.3

#### Main community-based management failures.

Community-based management needs time to become self-reliant and programmes must ensure a long period of follow-up and support. Short programmes must address this point and try to ensure that a local structure follows up with the water committee. Short programmes must manage long-term needs with short time-lines. If the system fails because the water committee was not properly prepared, a loss of community trust can occur.

Main system failures include:

- Management requirements are not achievable by the community because the water-supply system is not appropriate (in this case it is necessary to change the system).
- The community does not trust the water committee and stops payment of fees.
- Water-committee members are not fulfilling their duties.
- There is no transparency in the accounting and money is missing.
- Part of the community stops paying and then others stop also because they don't want to be among the few paying when others are not.
- Repairers are no longer available.
- No spare parts are available.

Once these problems arise, it is necessary to work closely with the communities to resolve them. This involves promotion and sensitisation within the community, with a focus on strengthening the capacity and performance of the committee. Suggesting the possibility of changing some members of the committee may be appropriate in some cases.

The most difficult problem to solve is when some water users are not contributing, and in these cases it is important to avoid conflicts within the community. There may be severe repercussions for non-payers and the lack of payment could be due to a lack of funds rather than a lack of cooperation. Ensuring that vulnerable people still have access to water is most important.

- In more complex water-supply systems, the rates can differ from one user to another depending on:
  - the type of connection: the contribution may be different depending on where the water is delivered:
    - . water points in public places such as schools, hospitals, places of worship, municipalities etc.;
    - . household connections;
    - . businesses, particularly where water is a raw material (extra charge);
  - the level of water consumption: measured by a meter at each connection, the number of buckets filled at the hand pump etc.
- Exemptions: as water has to be accessible for everyone, nobody should be excluded from the water service due to inability to pay the fee. Extremely poor families could be exempted and other solutions such as an equivalent labour contribution can be substituted.
- New connections: if users are added to the system after construction, they should pay an initial contribution equivalent to the work done by others during the construction or rehabilitation of the system, in addition to the cost of the connection.
- If non-payment is not justified, it is important that an agreed system of recourse is in place. A supplementary charge, or cutting the service until payment is made, are possible options. This issue should be addressed during the formulation of the management arrangements with the community in order to ensure that all non-payers are treated equally and reasonably. If such a system is not in place, payers will see that non-payers receive the benefit of water without contributing, and there will be little incentive for them to continue paying fees.

### 3.7.2 COLLECTION SYSTEMS

There is no fixed rule concerning how often people should contribute and how. It depends on several factors such as the type of system, the economic status of the users, agricultural cycles etc.

#### *Fixed periodic contribution*

This method enables a certain amount of money to be set aside to pay for repairs that otherwise would not be affordable. It can be made at an agreed time interval such as monthly, yearly or just after a harvest (when cash is available). This contribution is made by household, family or connection and is sometimes different depending on the type of connection.

#### *Occasional contribution*

People pay when there is a problem to resolve or a part to replace. This system may be more desirable when there are no regular costs such as consumables or hired staff. Also, if maintenance costs are low, such as for handpumps (e.g. suction pumps or rope-and-washer pumps) or for open wells, this may be the appropriate system. Activities such as parties, games, competitions, local lotteries etc. can be used to encourage people to contribute.

#### *According to consumption*

People pay for the amount of water consumed. This is a more common payment system when there are regular operational costs. Ways of measuring the quantity of water consumed will vary. Examples include measurement by container, by flow meter or by hours of use of the connection.

### 3.7.3 USER-FEE ESTIMATION

Normal operation and maintenance costs have to be covered by the community's financial contribution. If the system has been properly designed and the technology chosen is appropriate, the amount should be affordable for all the users. The right level of payment may not be easy to establish and it is recommended that the expected expenses across the life of the system installed are considered.

The total cost of system operation and maintenance should be calculated and communicated to the community. It is then the responsibility of the community to decide the user fees. The total costs include:

- *Operations costs*: expenses for daily operations (fuel, oil, electricity, chlorine, aluminium sulphate, salary of operators etc.)
- *Maintenance costs*: expenses incurred to prevent or to repair damages in the water-supply system (replacement of a joint, servicing of a pump, repair of a leak etc.). To determine this cost it is necessary to know:
  - type of maintenance (preventive and corrective);
  - anticipated frequency of maintenance;
  - materials and equipment required;
  - lifespan of the different parts of the water system and maintenance equipment;
  - water analysis and frequency of testing;
  - environmental services: aimed at preserving the water resources (reforestation, maintenance of protective fences etc.).
- *Administrative costs*: expenses for maintaining the physical and human support structure (trainings, stationery etc.).
- *Depreciation costs*: the objective here is to create a fund, through periodic contributions, so the community can afford to replace/rebuild the system at the end of its lifespan.

Once these costs are established, the community will decide on the type of contribution and the amount to pay by user or family.

The boxes 16.4 and 16.5 contain examples from Ivory Coast and Honduras showing different ways of calculating the contributions necessary for maintaining a Vergnet handpump and a gravity-fed system.

#### Box 16.4

##### Example of user-fee estimation: Vergnet handpump in Ivory Coast.

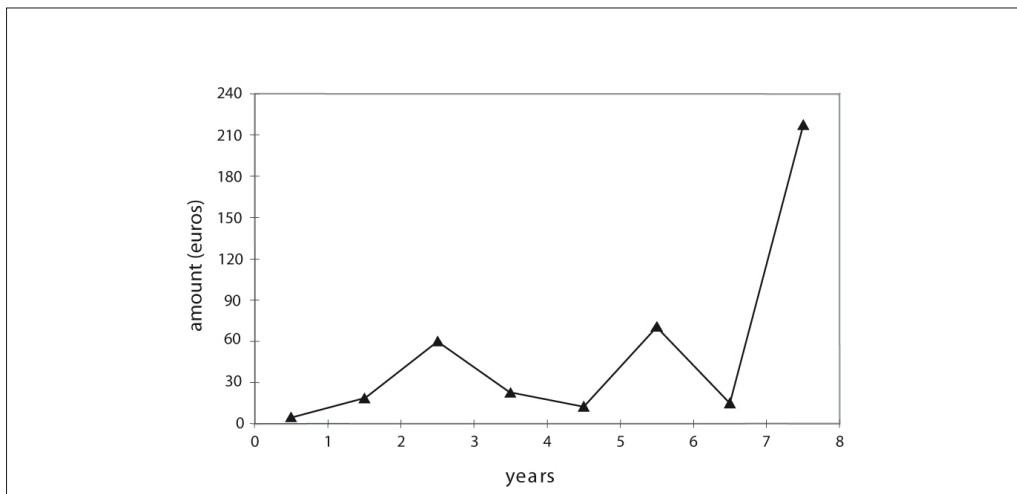
Costs to be covered by the users:

- Operations costs: none, no consumables and every user is responsible for fetching their water.
- Maintenance costs: depend on the intensity of use and the type of the pump. Mechanics report that during the first year the costs are minimal. However, costs increase over time, reaching a maximum between the 7<sup>th</sup> and 10<sup>th</sup> year (replacement of the balloon, the cylinder and the treadle).

Figure 16.3 shows the trend of the V4C pump maintenance cost over time (sources: craftsman-repairers interviews and data of SAHER – the replacement parts supplier, based on long experience). It shows clearly that regular contributions must be made from the moment the pump is installed in order to cover the costs that are incurred after several years of handpump use.

To ensure longevity of the pump, the committee must collect 60 €/year from the beginning so as to ensure there is not a large, unaffordable payment after seven years. According to *l'Hydraulique villageoise* (the public water department), the committee collects at least 90 €/year.

ACF field workers surveyed the number of families using each pump. The number varied from about 30 to 100 families per pump. In the most unfavourable case (contribution of 90 €/year for 30 paying families), the sum paid per family per month for drinking water is 0.26 €. In comparison, 1 kg of rice in Ivory Coast costs 0.38 €.



**Figure 16.3: Maintenance costs versus years of use for the V4C handpump.**

### Box 16.5

#### Example of user-fee estimation: water network in Yusguare (Honduras).

The water supply in Yusguare is a urban system fed by four pumping stations installed on wells and one surface-water source. The system delivers water to 438 families through private household connections. The storage capacity of the four water tanks is 350 000 litres. The calculated costs are indicated in the following tables.

#### OPERATIONS COSTS

Nb.	Description	€ per month
1	Operator's salary	120
2	Pumping costs (electricity)	227
3	Chlorine	80
4	Miscellaneous	5
<b>TOTAL</b>		<b>432</b>

#### MAINTENANCE COSTS

Nb.	Description	Cost in €	Quantity per year	Monthly cost in €
<i>Tools</i>				
1	Machete	7	1	0.58
2	Hoe	4.5	1	0.38
3	Shovel	3	1	0.25
4	Iron bar	11.5	1	0.96
5	Pickaxe	7	1	0.58
6	Saw	1	2	0.17
<i>Materials</i>				
7	Anticorrosion solution	4	1	0.33
8	Sandpaper	0.5	1	0.04
9	Spanner 36"	35	0.2	0.58
10	Gate valve 3"	19	0.5	0.79
11	Gate valve 1 1/2"	5	0.5	0.21
12	PVC pipe - 1 1/2"	4	4	1.33
13	PVC pipe - 1"	2	4	0.67
14	PVC pipe - 3"	14	3	3.50
15	Cement	3.5	3	0.88
16	PVC glue	5.7	0.25	0.12
17	Water analysis	18	4	6.00
18	Environmental services	22.7	12	22.70
<b>TOTAL</b>				<b>40.1</b>

## ADMINISTRATIVE COSTS

Nb.	Description	Unit cost in €	Quantity per month	Monthly cost in €
1	Stationery	22.00	1	22.00
2	Per diems	4.00	3	12.00
3	Training	3.50	1	3.50
4	Technical support	4.00	1	4.00
<b>TOTAL</b>				<b>41.5</b>

## DEPRECIATION

Description	Cost (€)	Quantity	Lifespan (years)	Yearly depreciation	Monthly depreciation
Electrical pumping equipment	1360.54	4	10	544.22	45.35
Wells	1723.36	4	30	229.78	19.15
Surface-water intake	544.22	1	25	21.77	1.81
Elevated concrete tanks	1587.30	1	25	63.49	5.29
Simple concrete tanks	1350.00	3	35	115.71	9.64
PVC pipeline	4.45	1800	30	267.00	22.25
GI pipe	16.33	167	40	68.18	5.68
<b>TOTAL</b>			<b>109.18</b>		

## CALCULATION OF THE CONTRIBUTION

Description	Cost in €
Monthly operations costs	432.00
Monthly maintenance costs	40.10
Monthly administrative costs	41.50
Monthly depreciation costs	109.18
<b>TOTAL COST</b>	<b>622.78</b>

Number of families: 450

Number of families paying: 405

Cost per user = total cost / number of contributors = 1.40 €/ month

This rate is adjusted each year for inflation. For the year of this example (2002), the inflation rate was 7.70%.





VI

## Specific interventions



# Emergencies

## A CAMP INSTALLATIONS

---

<b>1</b>	<b>Selection and planning of sites</b>	606
1.1	Guidelines	606
1.2	Layout plan	606
<b>2</b>	<b>Emergency shelters</b>	606

---

Concentrations of people in areas such as camps create environments which favour the propagation of diseases such as malaria, plague and typhus, and where there is a high risk of epidemics (e.g. cholera and other diarrhoeas). The higher the population density, and the less adequate and numerous the sanitary installations, the higher the health risks (Table 17.I).

**Table.I: Sanitary arrangements in a displaced-persons camp: infrastructure and layout to be planned depending on need.**

---

*Access to housing*

Planning of the site, dwelling areas etc. (sanitary corridor, water points, access road)

Building of basic shelter

Distribution of building materials

*Access to water*

Transport by tanker and distribution via tapstands

Pumping and treatment of surface water in tanks, treatment and distribution via tapstands

Boreholes equipped with handpumps

Borehole equipped with a submersible pump with a distribution network

Wells

Gravity distribution system from a spring catchment

Distribution of jerrycans (1 per family)

*Access to basic hygiene facilities*

Latrines, showers, washing areas

Refuse pits

Vector control

Distribution of soap (approx 100 g/person/month)

*Access to health services*

Dispensaries, health centres

*Access routes, fire-fighting, drainage etc.*

Creation of access routes (tracks, paths, spaces between dwellings)

Firebreak

Site drainage

---

# 1 Selection and planning of sites

When there is a choice of site, its selection must take account of all the possibilities of water supply and environmental sanitation (rainwater drainage, digging of latrine pits, site access). All environments which present problems (swamps, steep slopes etc.) should be excluded from the selection. The type of water supply is critical in determining the final choice of site.

Small-capacity camps (several thousand people) are to be chosen in preference to structures of very high capacity. Depending on the resources available for creating the camp, and the essential needs identified, camp development is planned by phases.

## 1.1 Guidelines

These values are summarised in Table 17.II.

**Table 17.II: Guidelines for planning camps (adapted from UNHCR 2003).**

Guidelines	
Dwelling area	
Total area of the camp (including access and infrastructure, 45 m <sup>2</sup> with small gardens included)	30 to 45 m <sup>2</sup> /person
Dwelling area	3.5 to 5.5 m <sup>2</sup> /person
Area per shelter (family)	14 to 30 m <sup>2</sup>
<i>Distances to be maintained</i>	
Between dwelling areas	15 to 50 m
To the water point	100 m
To latrines or showers	50 m
Between shelters	2 m
Firebreaks	30 m wide, every 300 m

## 1.2 Layout plan

Figure 17.1 shows an example of a camp layout that includes the dwelling areas (shelters), access routes, water-supply and sanitation infrastructure (drainage, latrines, showers and washing areas).

# 2 Emergency shelters

The first need of displaced people is to find refuge for themselves and their families, especially in harsh winter climates or during the rainy season. Generally, public buildings are immediately requisitioned to receive homeless people. But their capacity is quickly limited or saturated, so the people must build themselves shelters as quickly as possible.

Humanitarian agencies are usually asked to distribute tents or plastic sheeting to provide protection from the elements. In certain cases, agencies may support the construction of temporary shelters for the most impoverished, or help in the rehabilitation of existing buildings.

An example of an emergency shelter is the model shown in Table 17.III and Figure 17.2, developed in Liberia. Built of wood and matting, the shelter can house up to 20 people (5 x 6 m). Other types of shelter are also appropriate when they can be made of local resources and materials (wood, mud, leaves, woven matting etc.).

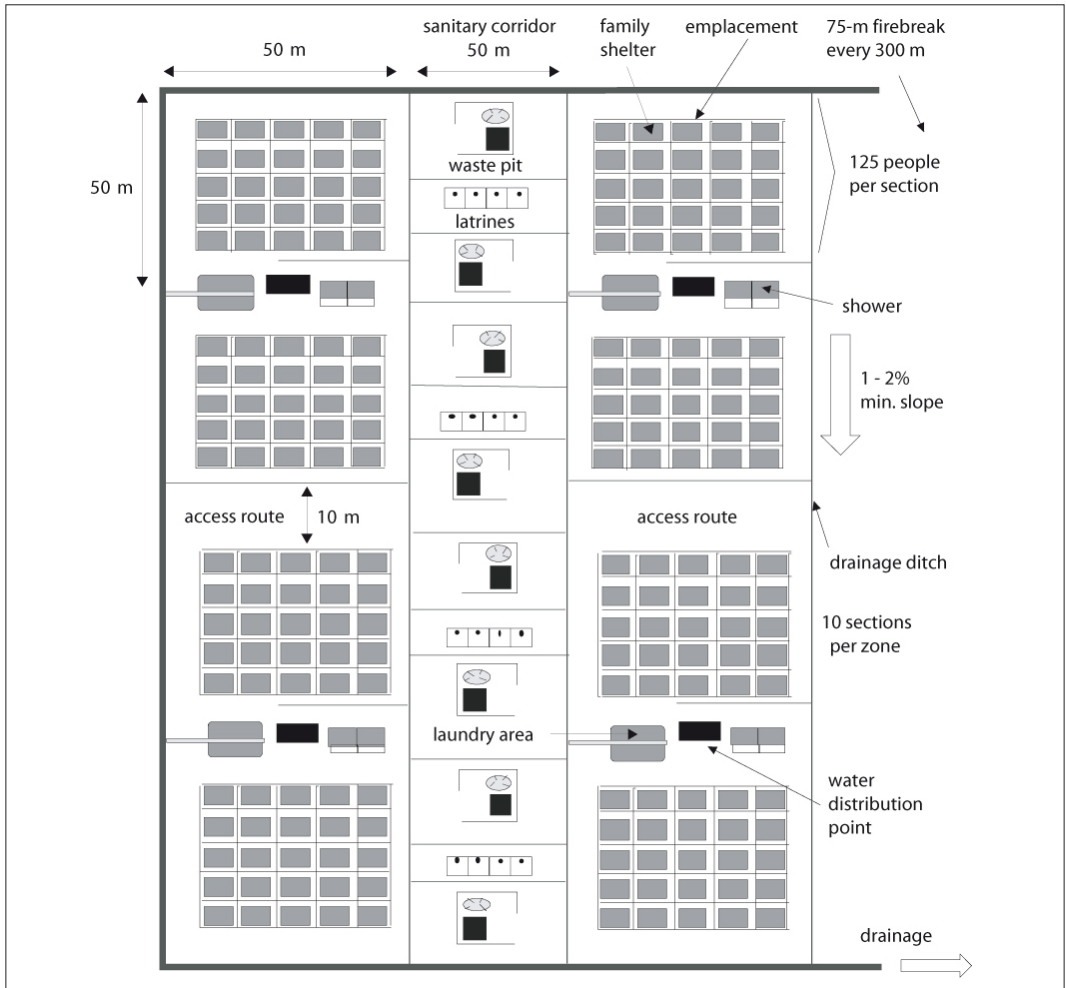
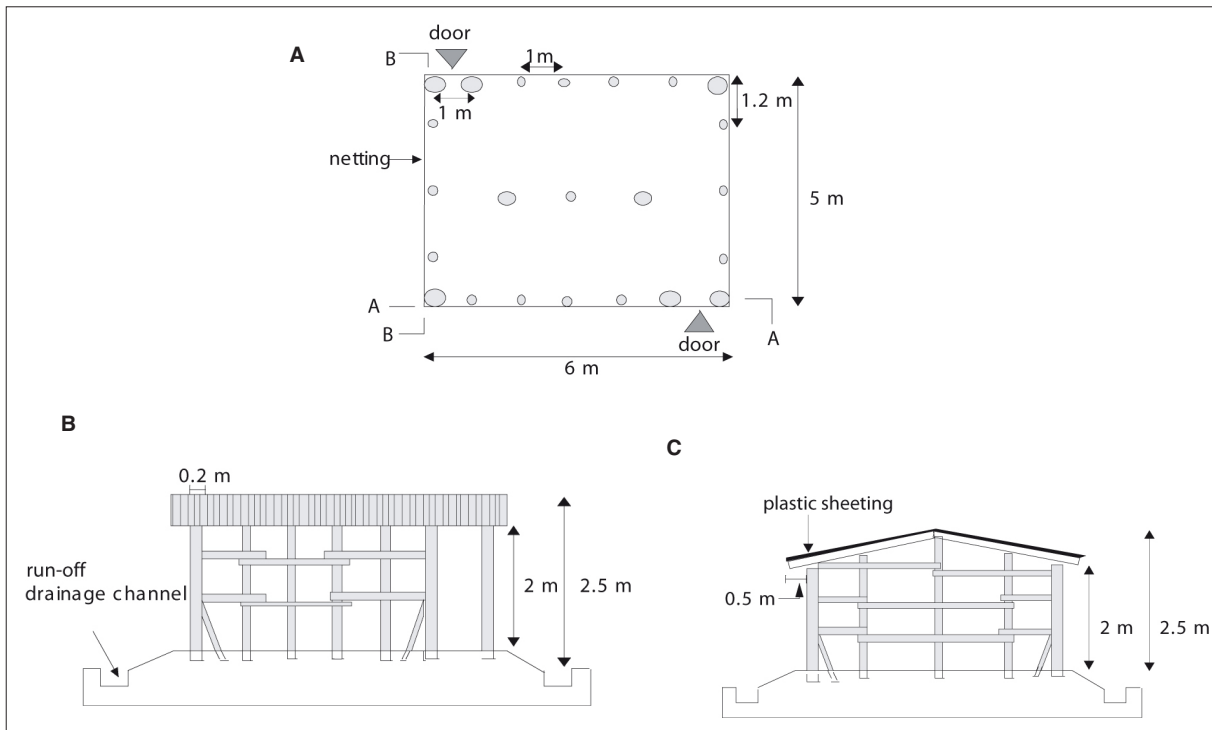


Figure 17.1: Layout plan of a camp (adapted from ACF, Rwanda, 1994).

Table 17.III: Characteristics and construction of emergency shelters for 20 people.

<i>Labour</i>	1 carpenter and 8 assistants for 6 days	
<i>Materials</i>	200 lengths of timber (3-m long, 0.07 to 0.15 m dia.) 10 to 12 kg nails 5, 8 and 10 cm 90 m <sup>2</sup> plastic sheeting or matting	
<i>Tools</i>	6 shovels, 6 picks 6 carpenter's hammers, 1 spirit level	30 m cord (4 mm dia.) 4 bow saws
<i>Construction</i>	Marking out the site area with stakes, digging drainage channels around the shelter, digging holes for poles (depth 0.40 m), spreading and ramming the soil removed, setting up poles maintained by oblique struts, stiffening with horizontal wooden braces  Roof construction with rafters every 20 cm in the direction of slope to avoid water pockets in case of rain (roof extending more than 0.50 m around the shelter), fixing plastic sheeting on roof and matting on walls	



**Figure 17.2: Plan of a collective emergency shelter (ACF, Liberia, 1994).**  
**A: plan of shelter. B: section A-A. C: section B-B.**

## B WATER TRUCKING

---

<b>1</b>	<b>Introduction</b>	609	<i>3.2.1 Background</i>	614
<b>2</b>	<b>The operation</b>	610	<i>3.2.2 Analysis of the situation</i>	615
2.1	Water tankers	610	<i>3.2.3 Identification of villages</i>	615
2.2	Distribution	611	<i>3.2.4 Estimation of water needs</i>	616
2.2.1	<i>Distribution points</i>	611	<i>3.5.5 Implementation</i>	617
2.2.2	<i>Water disinfection</i>	613	3.5.5.1 The trucks	617
<b>3</b>	<b>Case studies</b>	613	3.5.5.2 Tools	617
3.1	Water trucking in camps	613	3.5.5.3 Monitoring	
3.2	Water trucking in rural areas (pastoral & agro-pastoral communities)	614	and end of operation	617

---

### 1 Introduction

Water trucking is a quick solution to provide water in situations where the distribution system fails or does not exist, and it is commonly used as a first response in emergency situations. Rehabilitation and construction works require time and resources and in some situations it is necessary to provide a faster solution until a longer-term water supply can be established or the emergency ends.

Water trucking is commonly used in situations where the water-supply system has been destroyed or severely damaged (due to conflicts or natural disasters), where water resources diminish (during droughts) or are contaminated (by floods or human activities), or in the case of displacement of people to a place with no water supply.

However, water trucking should be a temporary solution, considering that it provides a very fragile water supply (problem of access for trucks, risk of mechanical or human failure) and that it is expensive and unsustainable. Therefore, the exit strategy must be anticipated before the beginning of the water-trucking operation.

Exit strategies involve more sustainable solutions in many cases. They depend on the context, and the main scenarios should be anticipated. Criteria to end water trucking operations must be carefully defined from the beginning and respected in order to avoid any negative effects such as creation of dependency. This is especially important in cases where the exit strategy doesn't lead to the construction or rehabilitation of longer-term water supplies. For example, a water trucking operation was temporarily supported in an urban area of Haiti when the existing privatised water-trucking system was put into jeopardy as a result of drastically increasing oil prices caused by road blocks during floods. After the floods finished, and access was restored, stopping water trucking meant the return to the previous expensive water supply where people had to pay for their consumption. Some sectors of the community did not accept the decision and they demanded a continuation of the assistance. Objective criteria for intervention, defined from the beginning and clearly communicated to communities and authorities, facilitate the understanding of the termination of the water-trucking operation.

Other important aspects to consider in the exit strategies are the attitude of the authorities and the political decisions regarding future infrastructure development and settlement planning. In the case of displaced populations, where permanent infrastructure construction encourages people to settle, the exit strategy is a political decision that must be carefully discussed at local, national and international levels. In some cases, water trucking can be replaced by cheaper intermediate solutions (e.g. emergency distribution systems) that don't necessarily encourage permanent settlement.

An important point to be considered in planning water trucking programmes is the assessment and exploitation of the water resource. The usual water source is either a surface-water treatment works, or a groundwater pumping station from a borehole or well. In this case, the quantity abstracted must be compared to the exploitation flow, so as not to over-exploit the resource. Pumping tests are carried out if needed (see Chapter 6). Bacteriological and physicochemical analyses are always essential (see Chapter 4).

*Note.* – In some peri-urban areas, water is supplied by tankers or donkey carts from pumping stations or from the distribution system, resulting in high water prices and vulnerability of the supply.

## 2 The operation

Water trucking programmes involve the management of the water source, the transport of the water by the trucks and the distribution to specific points (temporary distribution points such as bladder tanks with tapstands, or local housing infrastructure such as household or public storage tanks).

One of the main problems is the availability of trucks and the management of their movements; in many situations water is distributed directly from the trucks, which wastes time and supply capacity. Setting up tanks and distribution points and planning the movement of the trucks are essential to optimise the system (see Chapter 16, Section 2.3.10).

### 2.1 Water tankers

The most commonly used are standard two-wheel drive tankers, usually around 8 000 l capacity, reserved exclusively for water transport. Truck characteristics and tanker volume should be considered with respect to the availability of trucks in the area and possible problems of access (for instance, heavy trucks can be blocked during the rainy season).

If there are not enough water tankers in the area, or if they are very expensive, it is possible to adapt normal flat-bed trucks with bladder tanks or rigid tanks if they are well fixed. Tanks specially designed for water transport are divided into compartments, to limit the displacement of the water and to ensure better stability.

Calculation of the cost of the trucking system is important for defining the programme: cost of the purchase or rent of the trucks, maintenance costs, fuel consumption, salaries of the driver and other people involved, and cost of the water (and treatment) if it is necessary to buy it.

Fuel consumption depends on the type and condition of the trucks, and on road conditions. It is normally between 25 and 30 l/100 km.

Optimising the capacity of the supply also requires a good estimation of the time required to supply an expected volume, and good planning of the truck trips. The numbers of trucks and daily round trips required depend on the distance to the site and refilling and emptying times. Average speeds can be between 20 and 50 km/h in areas with not very good access conditions.

Truck refilling time depends mainly on the flow of the pump used (about 30 to 60 min). If the truck is emptied into a tank with a motor pump, the emptying time depends on the pump and the volume of the water, but it can be short (less than 30 min). If the water is distributed by gravity directly from the truck, the distribution time depends on the diameter of the outlet and the volume of water, but can be much longer than with motor pumps (more than 2 h for 8 m<sup>3</sup>).

Hire contracts with truck owners must be drawn up with attention to detail, in particular with clauses which clearly identify the hire company's responsibility:

- hire of the vehicle itself, without mileage limits;
- wages of driver and assistant;
- insurance;
- maintenance of the truck and possibly supply of fuel and oil;
- responsibility in case of accident, fire or theft.



In addition to this, some special clauses may be added, such as the possibility of changing the driver if unsatisfactory, or replacing the truck in case of prolonged breakdown.

## 2.2 Distribution

### 2.2.1 DISTRIBUTION POINTS

Direct distribution by water tanker is to be avoided for obvious reasons, including long discharge times, poor hygiene, difficult crowd-control etc. It is indispensable to set up specific distribution points or use existing distribution systems.

Distribution points should be as close as possible to dwelling areas. The trucks must be able to manoeuvre without difficulty to supply the storage tanks. These tanks are connected to one or more tapstands (Talbot or self-closing taps are recommended to avoid losses), depending on the layout of the site.

Bladder tanks, with a capacity of 2 000 to 20 000 l, supplied directly by truck, or from a mini-distribution system (see Chapter 11B), are widely used for temporary storage, and may supply water for health centres, feeding centres or cholera treatment centres. The water distributed is disinfected directly in these tanks (see Chapter 12) or in the tanker (see Section 2.2). If water is to be treated by plain or assisted sedimentation in the tanks at the distribution points then onion tanks or OXFAM-type tanks should be used, rather than bladder tanks (see Chapter 12 Section 1.3).

It is advisable that bladder tanks (Figure 17.3 and Table 17.IV) have two inlets/outlets, each with a ball valve and a 50-mm coupling, as well as a 120-mm central opening. A water point is connected to the 50-mm distribution pipe from the tank.

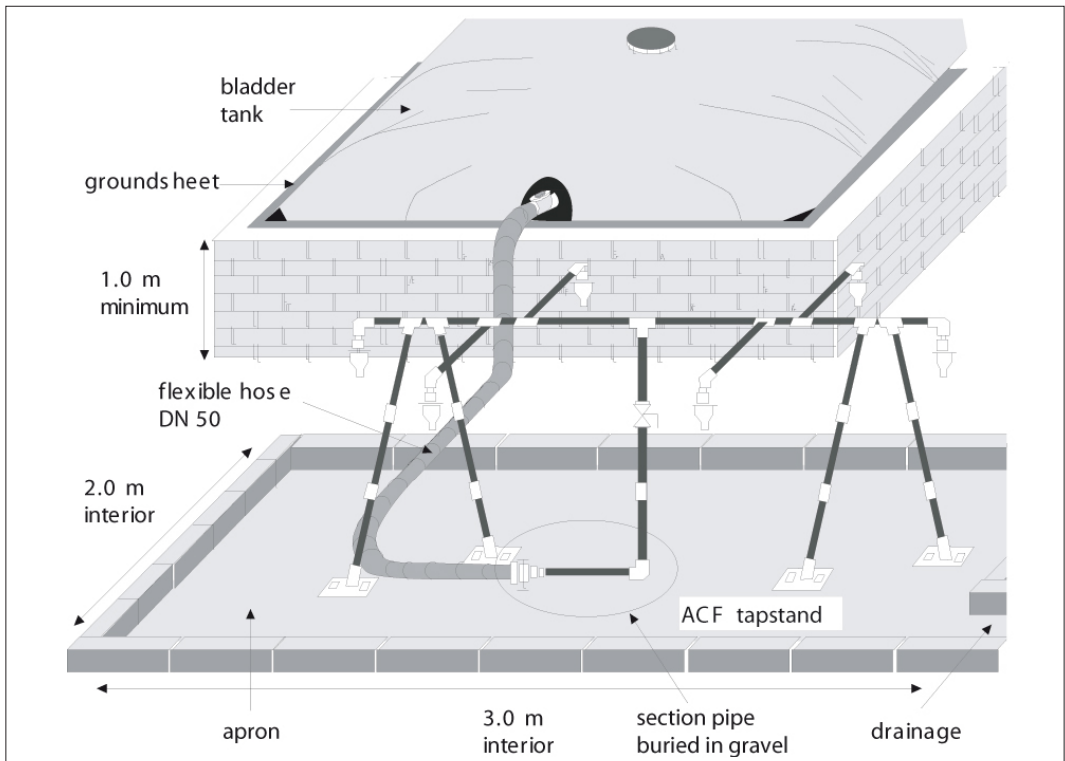


Figure 17.3: Flexible tank (bladder type) and tapstand.

**Table 17.IV: Characteristics and cost of flexible water tanks (2004).**

Item	Tank dimensions (m)	Cost (€)
Flexible tank kit- 2 000 l	2.85 x 2.00	650
Flexible tank kit – 5 000 l	4.00 x 3.00	1 345
Flexible tank kit – 10 000 l	5.10 x 3.00	950
Flexible tank kit – 20 000 l	7.50 x 4.00	1 300
Water point (tapstand kit)		270
50-mm semi-rigid pipe (heliflex, per 50 m)		300

The installation of the tank and water point requires a series of operations:

- choice of location: note that the tank should be higher than the tapstand (range of pressure for Talbot self-closing taps: 1 to 8 mWG);
- preparation of the ground for the water tank: perfectly level and clean (no gravel, rocks, roots etc.); a bed of sand may be necessary;
- laying an apron and drainage system for the tapstand;
- mounting the tapstand and fixing it to the apron.

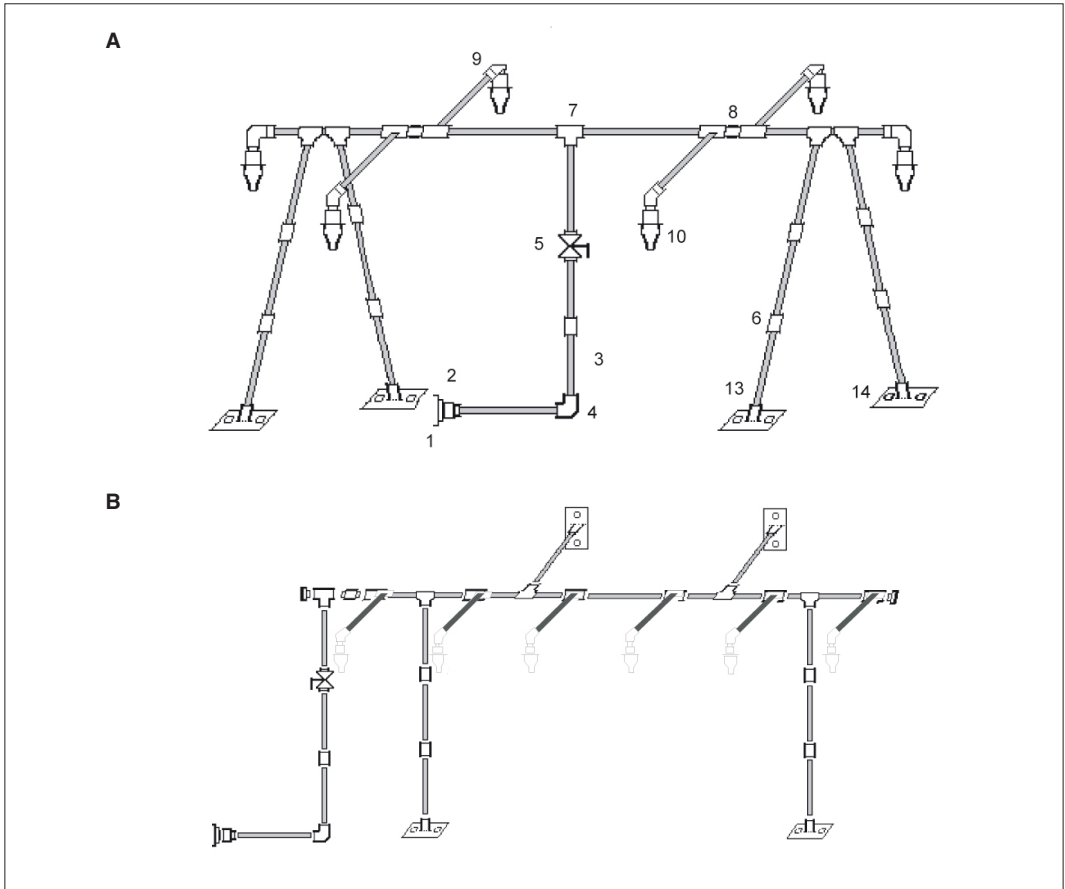
Tapstands are available as kits (Figure 17.4), and can be assembled in several different configurations (numbers of taps from 1 to 6 etc.).

Water distribution also requires safe containers for the families to transport and store the water. Families should have at least two collection containers (10 to 20 litres) and sufficient storage recipients to have water at the household at all times. Containers must be easy to fill and seal, such as jerrycans. If necessary, jerrycans should be distributed; cleaning and disinfection of the containers should be promoted through hygiene education.

In emergency situations, the pressure of people around the water point quickly becomes difficult to control: access to the water point must be restricted and distribution must be controlled by a supervisor. Management of the supply is also presented in Chapter 16, Section 2.3.10.

**Table 17.V: Contents of the ACF water-point kit.**

Item	Ref. Figure 17.4A	Quantity
2" fire-hose connection	1	1
F/F 50/60 2" → 1" reducer	2	1
26/34 pipe threaded at both ends (m)	3	24
90° F/F 26/34 1" elbow	4	1
26/34 1" ball valve	5	1
F/F 26/34 1" socket	6	9
26/34 1" tee	7	7
M/M 26/34 1" nipple	8	2
F 26/34 → 1" M 20/27 3/4" reducer	9	6
20/27 3/4" Talbot tap with elbow	10	6
M 26/34 1" plug	11	2
Roll of PTFE tape	12	3
26/34 connection for base-plates	13	4
26/34 base-plate	14	4
F 26/34 1" plug	15	1
Hex spanner	16	1
18" pipe wrench	17	1



**Figure 17.4: ACF tapstand kit.**  
**A: standard installation. B: installation against a wall.**

## 2.2.2 WATER DISINFECTION

Tankered water must always be chlorinated.

If the chlorination is done directly in the tanker while it is being refilled, the chlorine can act during transport (contact time > 30 min). Nevertheless, if the trip and the process of filling and emptying the truck tank takes much longer, protection provided by the residual chlorine will be less efficient. Another aspect is that chlorine is neutralised by iron, and chlorination is therefore not effective in a steel water tank not coated with food-grade paint.

Another possibility is to do the water disinfection and water quality control in the storage tank at the water distribution point.

# 3 Case studies

## 3.1 Water trucking in camps

This example concerns a refugee camp in Ethiopia (1992), without a water resource, and with a population of 10 000 people. The water had to be transported along 10 km of track from a borehole, while waiting for the extension of the distribution system from the nearest village.

**Table 17.VI: Calculation of round-trip time and estimation of the number of trucks needed.**

Refilling time	17 min
Journey time, borehole → camp	30 min
Emptying time	30 min
Journey time, camp → borehole	30 min
Round-trip time	107 min
30% downtime (breaks, refuelling)	30 min
Estimated duration	137 min (2.3 h)
Number of round trips per truck (12 h/day)	5
Volume of water transported per truck per day	5 x 5 000 l = 25 000 l
Number of water tankers required	180 000 l / 25 000 l = 7

Daily water demand was estimated at 150 m<sup>3</sup> (15 l/person/day), plus 20% losses in the distribution system, making a total daily requirement of 180 m<sup>3</sup>. The water tankers had a capacity of 5 000 litres. At an average speed of 20 km/h, the journey took 30 min. The refilling time of the tanker at the pumping station depended on the flow of the borehole (5 l/s), while gravity emptying took 30 min via a 75-mm pipe (Table 17.VI).

Therefore, seven 5 000-l water tankers making 5 round trips each could supply (in an ideal situation) 15 l/person/day to 10 000 people. It is nevertheless advisable to hire a supplementary truck to cover possible problems (breakdowns, punctures, disagreements with the owner etc.). The water tankers empty into four 20 000-l tanks, which supply the emergency water-distribution systems. These consist of 2 - 3 tapstands equipped with 4 to 6 taps, each supplying 0.1 to 0.2 l/s.

## 3.2 Water trucking in rural areas (pastoral and agro-pastoral communities)

### 3.2.1 BACKGROUND

Korahai zone, in the Somali region of Ethiopia, is a semi-arid region inhabited by pastoral and agro-pastoral people (rearing camels, cows, sheep and goats), whose livelihoods depend directly on water availability. Yearly rainfall, between 300-400 mm, is divided in two seasons: *deyr* (October-December) and *gu* (April-June). Since the 1980s, the region has been affected by recurrent low rainfall and by periodic droughts (locally considered as the lack of two rainy seasons coupled with rainfall deficit in the Highlands). Consequently, the region has less and less perennial water resources. The water points are constituted by deep boreholes, shallow wells (< 20 m) and birkads (see Chapter 19, Figure 19.2B), plus surface water (temporary rivers and natural ponds).

When the rainfall is not good, the aquifers that are exploited by the shallow wells are not recharged and birkads empty quicker than normal.

When such an event occurs, the communities implement the coping mechanisms that, according to the level of water shortage and loss of livelihoods, consist of:

- movement of livestock to other water points;
- costly water trucking by private transporters (for people and small livestock);
- taking credits;
- search for new income sources;
- migration;
- change in dietary habits;
- charity and humanitarian assistance.

Trucking water to supply the birkads (sometimes in bladder tanks) is one solution to avoid the total loss of assets for many people. But at the same time water trucking has negative side effects that must be taken into consideration before deciding on any intervention.

The risks are:

- breaking coping mechanisms;
- fixing populations in places where the natural water resources don't match needs;
- creating dependency on humanitarian intervention;
- developing a system that is locally driven by commercial operators and that excludes the poorest families;
- displacing the population to the distributions sites.

On the other hand, each year, during the dry season, people suffer from a level of water stress that could justify an intervention. But assuming that water trucking is an emergency response that can't be implemented each year, clear indicators must be defined in order to decide on the beginning of the intervention and its end. These indicators, linked to rainfall and economic parameters, are not easy to define objectively and are not always understood and accepted by the authorities and communities concerned.

### 3.2.2 ANALYSIS OF THE SITUATION

In February 2004, the first indicators of the crisis were:

- the previous rains (Deyr) were two months late and very insufficient;
- the Faffen seasonal river had a limited flow, not allowing any agricultural activities in the agro-pastoral areas in Korahai district;
- most of the birkads were emptied earlier than usual;
- the yield in wells were abnormally low and water salinity increased;
- 3 of the 10 borehole-pumping stations existing in Korahai district were not functioning;
- costly private water trucking, implemented sooner than usual, was the only source of water in most of the areas depending on birkads;
- the pasture was poor and therefore there were concentrations of livestock in better pastures, leading to over exploitation;
- denial of “water credit”\*;
- animal mortality was increasing;
- solidarity mechanisms broke down;
- a destocking process began;
- livestock prices in the markets went down.

In this context, ACF-Ethiopia decided to do deeper assessments in order to design a water-trucking intervention.

### 3.2.3 IDENTIFICATION OF VILLAGES

The targeted villages were selected according to the requests received from the local authorities and communities that ACF cross-checked through field assessments. These assessments collect two kinds of information, regarding the lack of water resource and regarding the economic situation. Intervention is decided on only when the scarcity of water generates (or can generate) disruption of livelihoods. The following information is gathered:

- rains (as rains are sporadic, really local assessments must be undertaken);
- productivity of existing water points (capacity, distance, pumping system etc.);
- current water-trucking operations;

---

\* Water credit is a coping mechanism often used for poor households in a normal year. But water credit starts to fail when the lenders see that the credit can not be reimbursed. A normal price to sell water in dry times is 2 birrs for 20 litres. For a household of 10 members, also providing water for a minimum part of the family's livestock, the credit could very high at the end of a drought period.

- type and state of economic activities (pastoralism, agriculture, business etc.);
- coping mechanisms developed (e.g. destocking, migration etc.);
- number of families and number of people present in the villages or camps;
- degree of settlement (customs and capacity to move);
- infrastructure (hospital, schools, markets etc.)

After the assessment, the degree of emergency and the water needs of each place visited are defined. Before starting water trucking in a village, there is a meeting with community leaders to draw up and sign terms of understanding. In the community, a committee is created to receive and manage the water.

### 3.2.4 ESTIMATION OF WATER NEEDS

The criteria to estimate the needs are complicated because of population displacement. They include both domestic and livestock needs.

Several assumptions are used for the estimation.

#### *Population*

- Number of houses = number of households.
- One household = 10 members (according to the 1994 national census).
- The minimum water supply in such situations = 10 litres per person per day (according to ACF standards, in Kebri Dehar).

#### *Livestock*

Since the start of the crisis, pastoralists moved with their camels, that can walk 8 to 10 days without drinking, to perennial water points (usually boreholes). The remaining livestock attached to the household in the targeted water scarcity areas are to be supplied through water trucking. This remaining livestock is mainly composed of weak, pregnant and lactating animals. Thus, the programme intends to provide water to the families for watering animals in order to limit loss of livestock and maintain milk production directly used by the family.

The Somali Livestock Unit (SLU) is used to estimate the daily water consumption of the livestock in a dry time:

- sheep: 10 l every 3 days = 3 l/d;
- goat: 15 l every 5 days = 3 l/d;
- donkey: 20 l every 2 days = 10 l/d;
- cattle: 40 l every 2 days = 20 l/d;
- camel: 160 l every 8 days = 20 l/d (camels will drink at perennial water points).

One SLU consumes 20 litres of water per day. Thus, 1 SLU corresponds to: 1 camel = 1 cow = 2 donkeys = 6.5 sheep/goats.

According to the 'Household Baseline Food Economy Survey in Korahai zone (ACF 2001)', the mean livestock for a 'very poor' pastoral household is estimated to be 5.5 SLU (an average of 2 cows, 1 donkey and 20 sheep and goats). The mean livestock for a 'very poor' agro-pastoral household is estimated to be 3.75 SLU (average of 1 cow, 1 donkey and 15 sheep and goats). The small and medium villages are considered as pastoral (animals being the only source of income) and the big villages as agro-pastoral or semi-pastoral (with agriculture, food-distribution points and business providing other incomes).

In conclusion, it is estimated that:

- one pastoral household needs a minimum of 210 litres/person/day;
- one agro-pastoral or semi-pastoral household needs 175 litres/person/day.

During the implementation phase, monitoring allows identification of errors in the estimations or particularities of a village and adjustment of the quantities of water to be delivered.

### 3.2.1 IMPLEMENTATION

#### 3.2.1.1 The trucks

During full programme implementation, 15 trucks were supplying 244 m<sup>3</sup> per day to 27 villages, covering an 88% of the estimated needs, taking water from 4 boreholes.

The trucks drive a mean of 160 km/day. The prices are: 55 €/day for the small trucks (6 m<sup>3</sup>) and 130 €/day for the big trucks (20 m<sup>3</sup>). From checking several trucks filling the fuel tanks before and after the trip, consumption was estimated to be 35 l/100km for small trucks and 45 l/100km for big trucks (Table 17.VII). Difficult sandy roads and trucks in bad conditions explain this high consumption.

**Table 17.VII: Water trucking cost.**

	Water supplied (l)	Truck rental (€/day)	km	Consumption (l/km)	Fuel cost (€/l)	Total water coast (€/l)
Small truck	6 000	55	160	0.35	0.4	0.0129
Big truck	20 000	130	160	0.45	0.4	0.00794

*Note.* – These prices don't represent the full cost of the water because staff were provided for free.

Specific unexpected problems occurred:

- clan conflicts limited access;
- the owners of cemented Birkads sold the water supplied;
- the Water Bureau tried to make a profit from water supplied from boreholes;
- armed groups and soldiers stopped the trucks and asked for water.

#### 3.2.1.1 Tools

Several tools have been developed to manage the water-trucking activity:

- a memorandum of understanding (two copies);
- a form to monitor the water supply, recording: date, village, water supplied, fuel consumption, driver's signature, ACF monitor's signature, water committee's signature and water remaining from the previous supply (see Table 17.IX);
- a form with names and roles for the members of the committee and management rules;
- a interactive 'Excel' workbook to monitor and update the water-trucking programme (see Table 17.VIII);
- a map with all GPS coordinates.

#### 3.2.1.2 Monitoring and end of operation

Every delivery is followed by an ACF monitor (see Table 17.IX), who fills in the forms and reports any problem. In this way, the quantity of water to be delivered can be adjusted and any other specific problems can be identified (e.g. new movements of population).

In the case of a problem, the supervisor visits the village. Particular attention is paid to migration caused by the water trucking and to bad water management (selling of water).

Because rainfall is the main water source for pastoral and agro-pastoral communities, the end of the operation will obviously be linked to the return of normal rainfall. When rainfall is sufficient to fill the birkads and the natural ponds and to recharge superficial aquifers, water trucking must be stopped even if people lobby for it to continue.

**Table 17.VIII: Needs coverage table.**

Site	Distance from borehole (km) (km)	Estimated number of houses	Estimated people supplied	Estimated SLU supplied	Estimated needs m <sup>3</sup> /day	Supplied water m <sup>3</sup> /day	Estimated needs coverage	Monitoring
Balawiriri	30	15	150	82.5	3.2	3.1	99%	
Karsoni	25	25	250	137.5	5.3	6.3	119%	To check
Xodayle	30	10	100	55	2.1	3.1	149%	Monitoring observed that water was finished before foreseen, because of migration Water supplied has been increased by 50% from previous estimation
Maracaato	30	200	2 000	750	35.0	33.0	94%	
Karambicile	25	15	150	82.5	3.2	3.0	95%	
Fooljex	40	10	100	55	2.1	1.5	71%	To check
Jiic	50	25	250	137.5	5.3	5.5	105%	
Gabo Gabo	75	180	1 800	675	31.5	26.7	85%	To check
Landher	62	45	450	247.5	9.5	9.4	99%	
Toonceley	85	25	250	137.5	5.3	5.5	105%	
Farmadow	92	100	1 000	375	17.5	16.8	96%	
Higloleey	60	150	1 500	825	31.5	19.7	62%	Monitoring observed that water was remaining from last supply because some salty wells are used to water animals Water supplied has been decreased from first estimation
...	...	...	...	...	...	...	...	
Direct beneficiaries			14 500	6 610	277	244	88%	

*Note.* – In the Afar region of Ethiopia, ACF implemented a water-trucking operation in 2002. Monitoring confirms the observation that water consumption from the bladders supplied by trucks was higher when the rains returned because people considered that they were no longer dependent on this water resource, and consequently they consumed it with less precaution. ACF was in the paradoxical situation of stopping the delivering water when consumption was at its highest, because water delivered was creating an artificial comfort that could have created dependency. This decision was difficult to accept locally, particularly because other actors went on assisting the population.

**Table 17.IX: Monitoring file.**

Truck			Owner							
Date	Village supplied	Borehole supplying	Litres of water	Litres of fuel for truck	Litres of fuel for generator	Driver's signature	ACF monitor's signature	Committee's signature	Water remaining	Comments



# Therapeutic feeding centres

<b>1</b>	<b>Introduction</b>	619	2.2.3	<i>Chlorination</i>	621
<b>2</b>	<b>Guideline and recommendations</b>	619	2.2.4	<i>Water analysis</i>	621
2.1	Guidelines	619	2.2.5	<i>Hygiene promotion</i>	622
2.2	Recommendations	619	2.2.6	<i>Health monitoring</i>	622
2.2.1	<i>Sanitation</i>	619	<b>3</b>	<b>Layout of a TFC</b>	622
2.2.2	<i>Water supply</i>	621			

## 1 Introduction

ACF often sets up both supplementary feeding centres (SFC) and therapeutic feeding centres (TFC) to address the problem of acute malnutrition. The SFC is a temporary structure, where patients stay very little time, for a few hours per day. The TFC is a much more permanent structure where the patient, with a carer, stays for approximately 1 month. Both types of centre require adequate water-supply and sanitation facilities.

Severely malnourished patients (often children) are immuno-deficient, meaning that they are less able to fight off infection than healthy people. The risk of rapid disease transmission or outbreaks in a TFC environment is therefore high. Patients who contract diseases in the TFC will take longer to recover from the severe malnutrition, and may suffer more serious consequences or even death. In order to limit the risk of disease transmission, it is therefore essential that adequate sanitary facilities are available and that strict hygiene rules are applied within the TFC environment. This chapter concentrates on the TFC.

## 2 Guideline and recommendations

### 2.1 Guidelines

The Table 18.I presents the water and sanitation guidelines for TFC.

### 2.2 Recommendations

The strict respect of the guidelines should protect the centre from sanitary risk. The staff must be trained in order to assure good cleaning, use, operation and maintenance of all the facilities.

#### 2.2.1 SANITATION

Considering the high concentration of people (vulnerable to infectious diseases) in such centres, sanitation requires special attention (for more detail on the following points, see Chapter 13):

- patients may come from different areas and may belong to different ethnic or religious groups, so socio-cultural, religious and gender issues must be carefully considered before designing sanitation facilities;

**Table 18.1: Water and sanitation guidelines for TFC.**

Activities	Means	Guidelines	Note
Supply of water	Borehole or hand-dug well equipped with pump (manual or electrical), or connection to distribution network Storage tank filled from outside source by water trucking Tanks connected to tapstands (in the case of water trucking, distribution system or motorised pumping) Chlorine <sup>1</sup> etc.	45 to 90 litres / patient and carer/ day Drinking water is chlorinated Drinking water is available in each room with patients, kitchen, admission section etc. Safe water is available for domestic uses Tanks are sufficient to avoid any shortage of water	Residual chlorine is 0.5 mg/litre (never less than 0.3 mg/litre) Turbidity <sup>2</sup> less than 5 NTU No colour 0 faecal coliforms / 100 ml of water <sup>2</sup> Mineral contamination respects MoH or WHO guidelines <sup>2</sup> (attention must be paid to nitrite and nitrate)
Access to facilities for washing	Washing area for clothes and dishes Bathrooms Soap in all of these facilities Hand-washing drums at the exit of latrines (chlorinated water)	1 washing area for 50 carers per day 50 persons / bathroom / day Bathrooms are lighted at night Water drums are placed in all the rooms	Facilities are cleaned on a daily basis with 0.2% chlorine solution Dishes and clothes are washed with soap or 0.2% chlorine solution 0.05% chlorine solution is used for washing hands Public towels, usually used to dry hands, are forbidden
Toilets <sup>3</sup>	Ventilated improved pit latrines (or pour-flush latrines if possible) Potties for children	25 persons/toilet/day Latrines are close to the building Latrines are constructed at least 30 m from wells and boreholes Latrines are lighted at night	Facilities are cleaned on a daily basis with 0.2% chlorine solution, taking care not to put chlorine in the latrine pits (this would stop excreta decomposition) Ashes are thrown inside the pit to reduce the smell and flies
Solid-waste disposal <sup>3</sup>	Refuse pits Dustbins Incinerators	At least 1 refuse pit per centre At least 1 incinerator per centre Dustbins distributed in the whole centre	Refuse pits are covered with lids Smoke from incinerator is under control
Environmental sanitation <sup>3</sup>	Drainage channels Grease traps Septic tank Soakaway pit Infiltration trench Cleaners	Enough drainage channels to remove all the wastewater One grease trap at the outlet of the kitchen Floor cleaning in living rooms every day	Drainage channels are cleaned on a daily basis (avoiding drainage towards neighbouring habitations) Waste disposal installations are well maintained Ground and floor cleaning is done with water to avoid dust Stagnant water is removed
Hygiene promotion <sup>4</sup>	Health-education promoters Posters Training sessions	Visual aids are distributed in the whole centre to explain the use of facilities	
Vector control	Mosquito nets Use of insecticides Environmental sanitation facilities		Drainage channels are cleaned on a daily basis Surface water is drained out of the centre

1. For the chlorination of water and the preparation of stock solution, see Chapter 12.

2. For water analysis, see Chapter 4.

3. For all sanitation issues, see Chapters 13 & 14.

4. For hygiene promotion, see Chapter 15.

- most of the patients are children, and require special precautions;
- desludging of latrines has to be well managed and anticipated before the pits fill up;
- permanent structures must be installed as soon as the context allows it;
- kitchen and washing facilities produce a lot of oil and grease, that must be properly managed with greases traps, to avoid accumulation.

## 2.2.2 WATER SUPPLY

Water supply will be effective if the installation remains in a good state (cleaning and maintenance) and is used in the proper way (see Chapters 7, 8, 15 and 16). The staff must have adequate technical skills: special attention should be given to the routine maintenance of the pumps, as any shortage of water could stop the running of the centre. Spare parts always must be available.

In the case of electrical or diesel pumps the technology chosen should be appropriate to local skills (specific training must be given to the person in charge of operation) and access to consumables must be ensured by keeping sufficient stocks (in conflict situations, access to diesel or petrol can be difficult).

Regarding hygiene around water points, the staff must be vigilant to avoid any stagnant water.

## 2.2.4 CHLORINATION

From ACF's experience, it is recommended to prepare a stock of only one kind of chlorinated water for the whole centre: water with a residual chlorine of 0.5 mg/litre (concentration for drinking purpose). More chlorine is added to this water to reach the concentration required for other specific uses (see Table 18.2), making only enough solution to meet the immediate need, to avoid storing several different chlorine solutions, which can lead to confusion and misuse.

For technical details, see Chapter 12.

**Table 18.2: Chlorine concentration per use.**

Chlorine concentration	Use
0.5 mg/litre	Drinking water
0.5 g/litre (0.05%)	Hand washing
2 g/litre (0.2%)	Daily cleaning of latrines and bathrooms
	Cleaning of water-storage tanks
	Cleaning of items in contact with patients who have diarrhoea (bed, blanket etc.)
	Dish and clothes when necessary

## 2.2.5 WATER ANALYSIS

Water analysis and chlorination must be done properly, and the person responsible must be specifically trained, including sensitisation about the purpose of the chlorination and the analysis (objectively and importance of daily monitoring).

The main water-quality parameters to be checked are as follows (see Chapters 4 and 12):

- pH: when choosing and designing any treatment process;
- turbidity: when there is any suspected change in turbidity of raw water, and regularly to check the effectiveness of a clarification process;
- free chlorine residual: daily.

The supervisors of the centre (both expatriate and national staff) and the hygiene promoters must also be trained in the water analysis and chlorination techniques.

When assisted sedimentation is done before chlorination, control of residual coagulant must be done on a regular basis. In the event of problems, information is transmitted to people in charge of treatment. This must be included in the training.

## 2.2.6 HYGIENE PROMOTION

The first objective of this activity is to protect the centre from any sanitary risk. But hygiene promotion also aims to improve hygiene practices for when people will go back home. The hygiene promoter has to keep in mind that water for hand-washing at toilets, washing facilities and sometimes also safe water-points and latrines, do not exist in the area where people are living. Therefore, adequate hygiene promotion should be done before patients leave, and this should be adapted to the living conditions of the people.

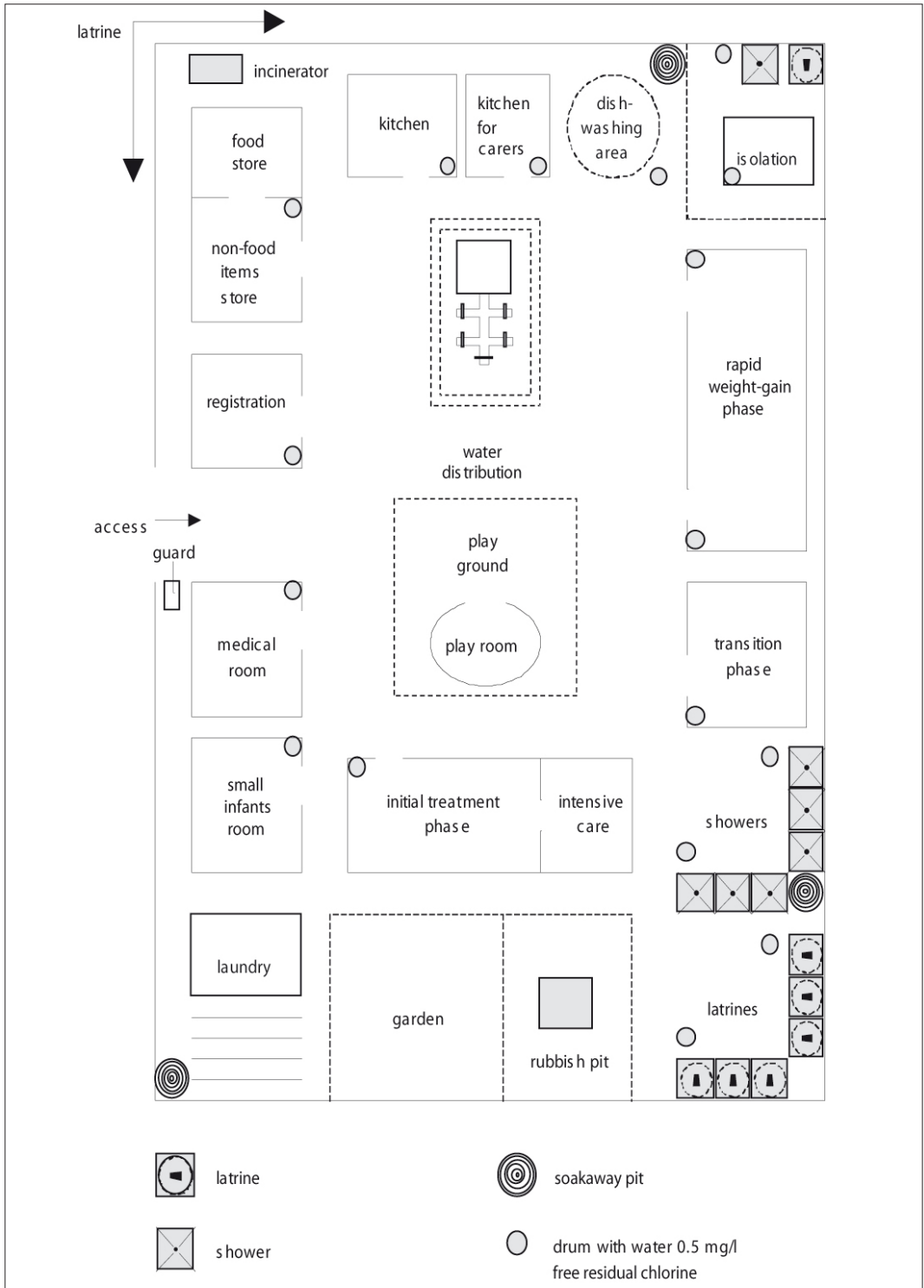
Because diseases related to poor hygiene, water supply and sanitation are one of the underlying causes of malnutrition, hygiene promotion must be done carefully (see Chapter 15) and should include promotion of sanitation and use of safe water.

## 2.2.7 HEALTH MONITORING

Patients' health must be monitored in order to identify any diseases linked to sanitary problems. Data are available from the ACF nutritionist in charge of the centre or from health centres where patients may be referred by ACF. From week to week, the evolution of health data can help to check that water, sanitation and hygiene are satisfactory and to react quickly in case of problems.

# 3 Layout of a TFC

Figure 18.1 shows an example of the layout of a TFC.



**Figure 18.1:** Example of layout of a TFC (adapted from the ACF book, *Assessment and treatment of malnutrition in emergency situations*, Action contre la Faim, 2002).



# Ponds

<b>1</b>	<b>Types of pond</b>	625	2.4	Human and financial resources	628
<b>2</b>	<b>Community impluvium ponds: the example of Myanmar</b>	626	<b>3</b>	<b>Pastoral run-off ponds, example from Ethiopia</b>	629
2.1	Feasibility study	626	<b>4</b>	<b>Examples of water-collection systems</b>	632
2.2	Technical recommendations	626	4.1	Well beside the pond	632
2.3	Design example	627	4.2	Filtration	633

Surface-water sources, such as ponds, are sensitive to surface pollution, particularly bacteriological pollution. However, they should not be neglected as a source of drinking water, because usually there is a great demand for surface water in contexts where no other water source exists (e.g. where groundwater is difficult to exploit, due to the depth of the aquifer or high salinity), and in contexts where maintenance is not likely (i.e. on transit routes in some pastoral areas).

## 1 Types of pond

Two types of ponds exist: impluvium ponds and run-off ponds. Impluvium ponds are used in places where precipitation is high (humid tropical areas, e.g. South East Asia). These ponds do not have a catchment basin, but collect the rainwater that falls directly onto their surface. Water quality thus depends on the sanitary conditions of the pond (cleanness, presence of animals etc.). In this case, adequate design and construction (including the installation of features such as appropriate water-drawing structures), and water-point management can lead to satisfactory water quality, and the water can be used for domestic and drinking purposes.

Where precipitation is low, in the so-called arid and semi arid lands (ASAL) such as the Sahel, the Horn of Africa, the Kalahari etc., the ponds are located in low-lying areas and collect run-off water (see Chapter 3 and Figure 19.2). Given all the opportunities for contamination during run-off, water quality is poor. On the other hand these ponds are mostly used in areas populated by pastoral communities and are mainly used for animal consumption. This also increases the risks of water contamination. In these pastoral areas, ponds may be used by different clans or communities and are usually isolated from permanent settlements. Water-supply management cannot, therefore, be done on a regular basis and any sophisticated installations should be built only after analysing operation and maintenance constraints.

In any case, the risk of water contamination remains high and treatment before consumption (by boiling, filtering etc.) is the best way to guarantee access to safe drinking water.

The inhabitants generally know how to build or rehabilitate ponds or rainwater reservoirs, but to optimise them and ensure longer service life, certain rules and construction parameters must be observed.

## 2 Community impervium ponds: the example of Myanmar

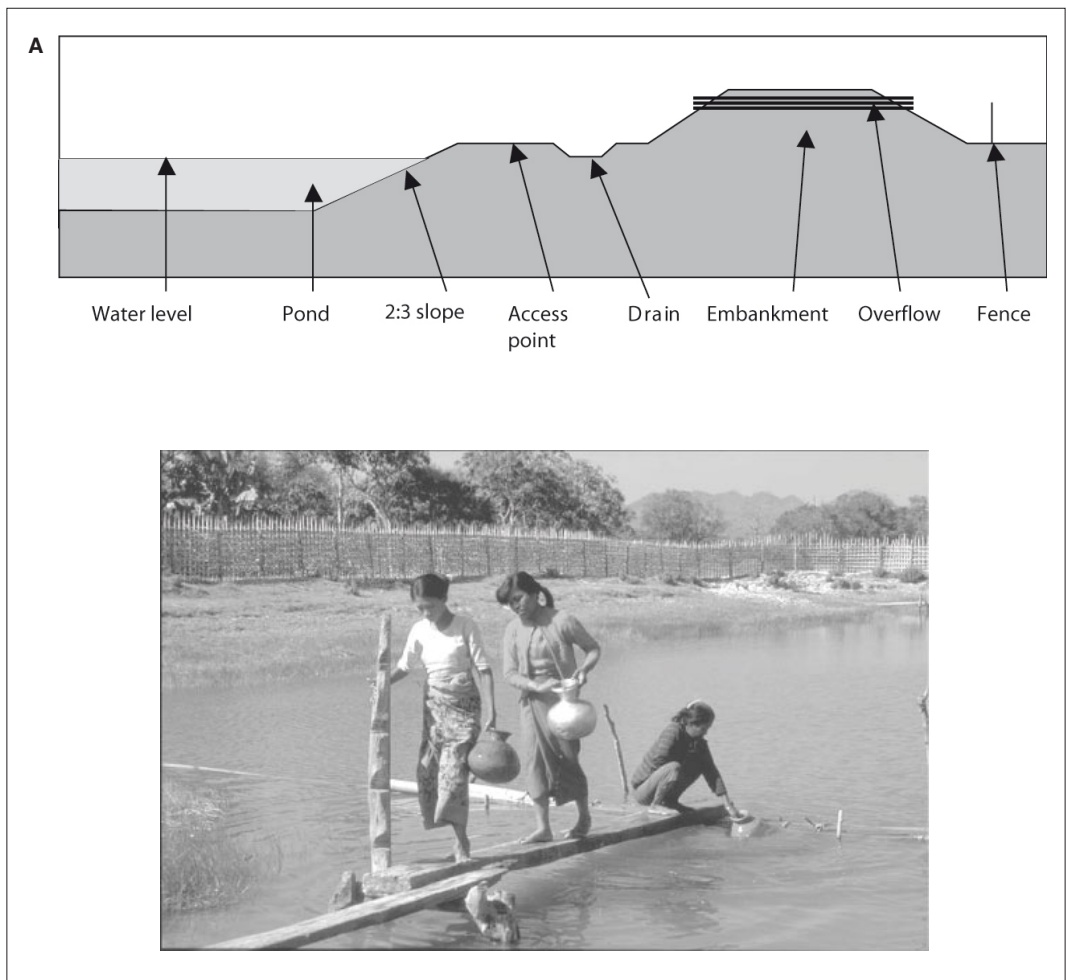
### 2.1 Feasibility study

The feasibility study deals essentially with the nature of the subsoil, which must be impermeable (tests and observation on site, digging trial holes), and also with rainfall and evaporation, in order to size the pond on the basis of demand.

The availability of land for these ponds is sometimes low when land pressure is high (agricultural land, ownership problems etc.).

### 2.2 Technical recommendations

The work entails various elements shown in Figures 19.1. The pond itself is an excavation carried out in impermeable ground. The embankments which surround it are built with the excavated material. They protect the pond from run-off and limit access. The overflows allow excess rainwater to be drained off, and therefore ensure the protection of the structure. The pavement and drain protect



**Figure 19.1: Community pond (ACF, Myanmar, 1996).**  
**A: construction plan. B: water-collection system.**



the pond against run-off from the embankments. The fence and the water-abstraction area, which is set on a floating pontoon, help to protect the water against pollution. The pontoon allows people to draw water from not too close to the banks, where water is clearer and cleaner.

All slopes (embankments, excavations) are 66% (2 height units per 3 width units). The surface area of the whole pond system is therefore much higher than just the surface of the pond, see Figure 19.1A.

Before commencing excavations, the ground is set out to mark the various parts of the structure (embankments, overflows, protection fences), and indicate excavation levels.

Stabilisation of the embankments is carried out as digging advances, by successive layers, with a manual rammer or compactor. The ground is wetted slightly to ensure compaction; insufficient compaction can result in the failure of the structure when it is first filled with water.

When building large ponds, adequate compaction of the ground is checked with a manual dynamic penetrometer (an instrument which measures the depth of penetration of a standard needle or cone into the material under standardised conditions of loading and time).

As the excavation advances, samples are taken every 50 cm to verify that the ground still contains sufficient clay, and corresponds with the feasibility study results, based on a precise geological section of the first few metres plus permeability tests. In the absence of impermeable subsoil, it is possible to compact clay laid on the base of the pond (0.5 m) or to install a waterproof membrane, which is expensive and more difficult to install.

The embankments are covered with soil, and grass is planted to prevent erosion: perennial, ground-covering, shallow-rooted species should be used. Bushes and small shrubs are not suitable, because their roots encourage water infiltration. An effective and suitably large overflow is located at the appropriate side (at least 1 m below the top of the embankments). The downstream section, where the water flows, is lined with stones and is concreted for the first metres.

Finally, to improve the quality of the drinking water, some simple measures are needed, such as a protective fence made of wood or bamboo or, even better, a fast-growing hedge to prevent access by animals.

Water is generally drawn directly using a jar or bucket, which has the advantage of being very rapid. In order to prevent people from drawing water at the edge of the pond, access pontoons (fixed or floating), which are easy to make, should be provided. Some systems provide protection, especially the installation of a handpump in a well supplied by a drain from the pond (see Section 4.1), or directly in the pond itself: proper use of this type of system depends a lot on local customs.

### 2.3 Design example

This design example concerns a village in the Mangdaw region of Myanmar which has 500 inhabitants. Two boreholes drilled here proved to be negative (saline water), and the inhabitants asked ACF to help them to improve their rainwater-storage pond, a traditional water source in the region.

In order to work out the volume of the pond, it is best to use average monthly data on precipitation and evaporation, and then compare the cumulative demand with the annual volume of recoverable rain (see Chapter 10A). As monthly data was not available for the region, annual estimates were used. Average annual rainfall was taken as 4 000 mm, and the average annual temperature as 25 °C (see Annex 6). Evaporation from the water body could not be calculated exactly, because no direct measurements had been made (e.g. with an evaporation tank, or evaporation meter) and the usual formulae (Lugeon's formula, Meyer's formula, calorific balance etc.) are difficult to use because they require a large number of parameters. Use of the simple Turc's and Coutagne's formulae given in Annex 6 is reserved for the calculation of flow loss in a catchment basin. Therefore, strictly speaking, they should not be used to calculate the evaporation from a water body. As an indication, Coutagne's formula gives an annual real evapotranspiration rate (RET) of 1.1 m, whereas Turc's gives 1.6 m; rough estimates of the average annual evaporation from free surface water given in the literature (Réménieras) indicate values of 1.5 to 3 m for humid tropical regions. The 1.5 m value was therefore assumed.

The amount of useful water available for refilling the pond is therefore:

$$4.0 - 1.5 = 2.5 \text{ m/year, or } 2.5 \text{ m}^3 \text{ per m}^2 \text{ of surface area.}$$

Water demand of the inhabitants is assumed to be 30 l/person/day over a period of 7 months in the year. In practice, the inhabitants use jars to recover the rainwater that falls on their roofs during the rainy season (5 months). Even when rainfall stops for a few days, people go to the pond without affecting the water reserve given that any water taken is replaced by rain immediately after.

Therefore, in one year, total demand is:

$$0.03 \times 500 \times 365 \times 7/12 = 3\,200 \text{ m}^3$$

To cover demand, the minimum area of the pond can therefore be calculated considering the useful rainfall per square metre:

$$3\,200/2.5 = 1\,280 \text{ m}^2$$

Ponds have a trapezoidal design (see Figure 19.1) and the volume is calculated through the following formula:

$$V = (l-h/p)(w-h/p)h \quad \text{Formula (1)}$$

where  $V$  = pond volume ( $\text{m}^3$ ),  $l$  = pond length (m),  $w$  = pond width (m),  $h$  = water height (m),  $p$  = bank slope (vertical/horizontal) (non-dimensional).

The pond is 40 m long ( $l$ ), 25 m wide ( $w$ ) and 1.3 m deep ( $h$ ). According to the nature of the soil, the slope of the banks in the area is usually 2/3.

The pond surface is  $40 \times 25 = 1\,000 \text{ m}^2$  and its volume is  $1.140 \text{ m}^3$  (see formula (1)), which is clearly inferior to population needs and justifies an increase in the pond size.

As the surface area is inferior to the minimum of  $1\,280 \text{ m}^2$  required, it must be increased to collect the necessary volume of rainwater. In order to maximise the increase in volume respective to the increase in surface area, the width of the pond should be increased, rather than its length. Therefore, the maximum volume of the pond corresponding to a surface area of  $1\,280 \text{ m}^2$  is obtained with  $l = 40$  and  $w = 32$ .

To increase the volume of the pond, the best solution is to increase the depth, in order to limit losses by evaporation (which are proportional to the surface area) and also because of the problems of access to land. Soil drilling showed that a clay cap is present down to 3.3 m, so the depth was set at 3 m, which allows 30 cm of clay to be kept above the permeable formation.

The volume calculated with formula (1) is then:

$$V = (40 - (3/2 \times 3)) \times (32 - (3/2 \times 3)) \times 3 = 2\,930 \text{ m}^3$$

If the volume is inferior to the expected volume, the surface area must be increased. Increasing the width up to 35 m,  $V$  becomes  $3\,250 \text{ m}^3$ , which corresponds to the needs identified. The pond will be 40 m long, 35 m wide and 3 m deep.

Overflows are installed to drain off rainwater in case the pond has been under-dimensioned, which is quite possible because several estimations are included in its design.

## 2.4 Human and financial resources

Generally, building village ponds is very labour-intensive, but labour can be provided by villagers through voluntary community participation or remuneration in food for work or cash for work. A food security analysis (particularly food availability and accessibility) should determine the appropriate form of participation. To carry out the excavation and compacting, people are organised in groups of 9, each group with a leader. Presence is recorded daily and payment is based on the excavated volume, but the number of working days is also taken into account, considering that certain formations are harder to

**Table 19.I: Example of costs for of a pond excavated manually (ACF, Myanmar, 2003).**

Excavation volume	2 950 – 1 150 = 1 800 m <sup>3</sup>
Number of person-days to excavate the pond	1 470
Number of people on the site	70
Number of working days	21
Cost of excavation / m <sup>3</sup>	0.7 €
Cost of labour	0.7 x 1 800 = 1 260 €
Cost of pontoons	200 €
<b>TOTAL COST</b>	<b>1 460 € *</b>

\* The cost is modified according to the number of working days

dig. This system is appropriate to local culture and customs, as fraud is unheard in these communities (Table 19.I).

Ponds and reservoirs can also be made more quickly using mechanical shovels and a bulldozer. However, hire of excavation machines, if they are locally available, is generally expensive (several hundred euros per day). Digging by hand or by machine should be studied and the most appropriate solution chosen depending on the local context. Creating a pond in a village by hand usually provides significant income in terms of money or food. This is important for food security, and this aspect must be taken into account in the decision.

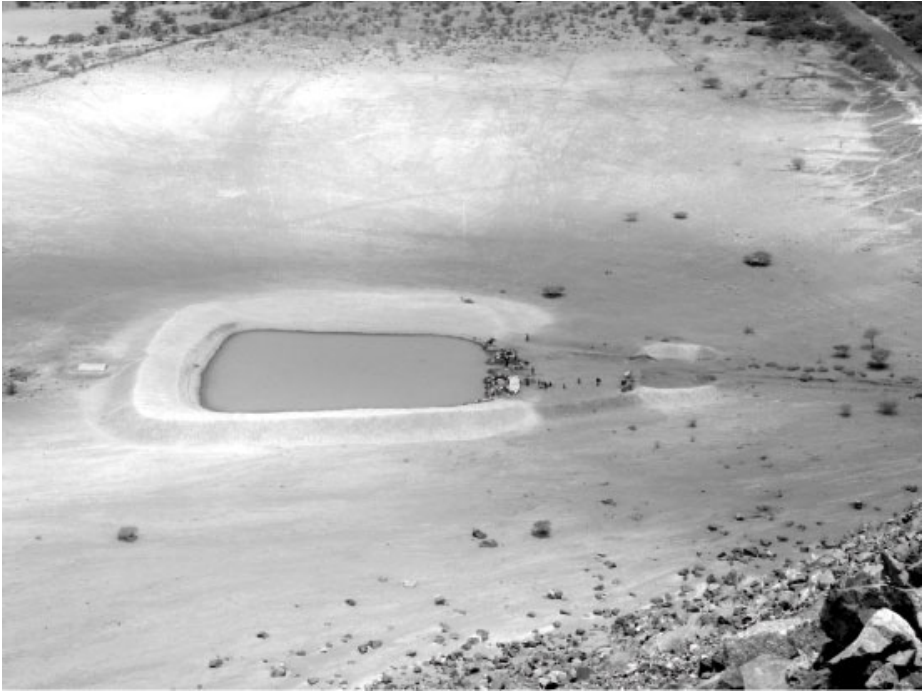
### 3 Pastoral run-off ponds, example from Ethiopia

In the Afar region of Ethiopia, ACF is implementing a pastoral project, including animal health and water supply. The main objective of the programme is to decrease the vulnerability of pastoral communities to drought, increasing the number and the sustainability of water points. Within this project ponds have been constructed in order to supply water to livestock. As explained in Section 1 these ponds collect run-off water. Figure 19.2A shows such a pond in aerial view. These ponds usually contain several thousand cubic metres of water and are usually communal or public structures. They are constructed as explained in Section 2, see also Figure 19.3. Smaller run-off collection reservoirs, called birkads, also exist in arid and semi-arid regions. They have a capacity of several hundred cubic metres and are usually used for domestic consumption as well as small livestock (goats and sheep), and are usually private structures. They are built in stone and mortar (see Figure 19.2B) and can be covered by wire and vegetation to limit evaporation.

Figures 19.3A & B show plans of a pond constructed by ACF in 2004. ACF introduced some improvements to the simple traditional model in order to reinforce sustainability by reducing erosion and sedimentation, and limiting water contamination. The main differences with the impluvium model are the entrance channel and the absence of a drain and overflow. The run-off catchment area can be improved with barriers in order to increase run-off water collection.

The pond is filled by short run-off events that transport a lot of sediments that quickly decrease the useful capacity of the pond. In order to reduce this problem, a silt trap or mud pit is constructed for the water to pass through prior to entering the pond, and this catches most of the sediments transported. The mud pit must be big enough to catch at least the sediment transported in one year. Dimensions for the mud pit are chosen according to local experience and observation, and depend mainly on the velocity of the water entering the pond and on the nature of the soil. Mud pits must be regularly maintained (emptying and consolidation), activities which can be difficult to carry out if no community is living close to the pond, which is frequently the case in pastoral areas. If no maintenance is carried out the mud pit will quickly become useless.

A

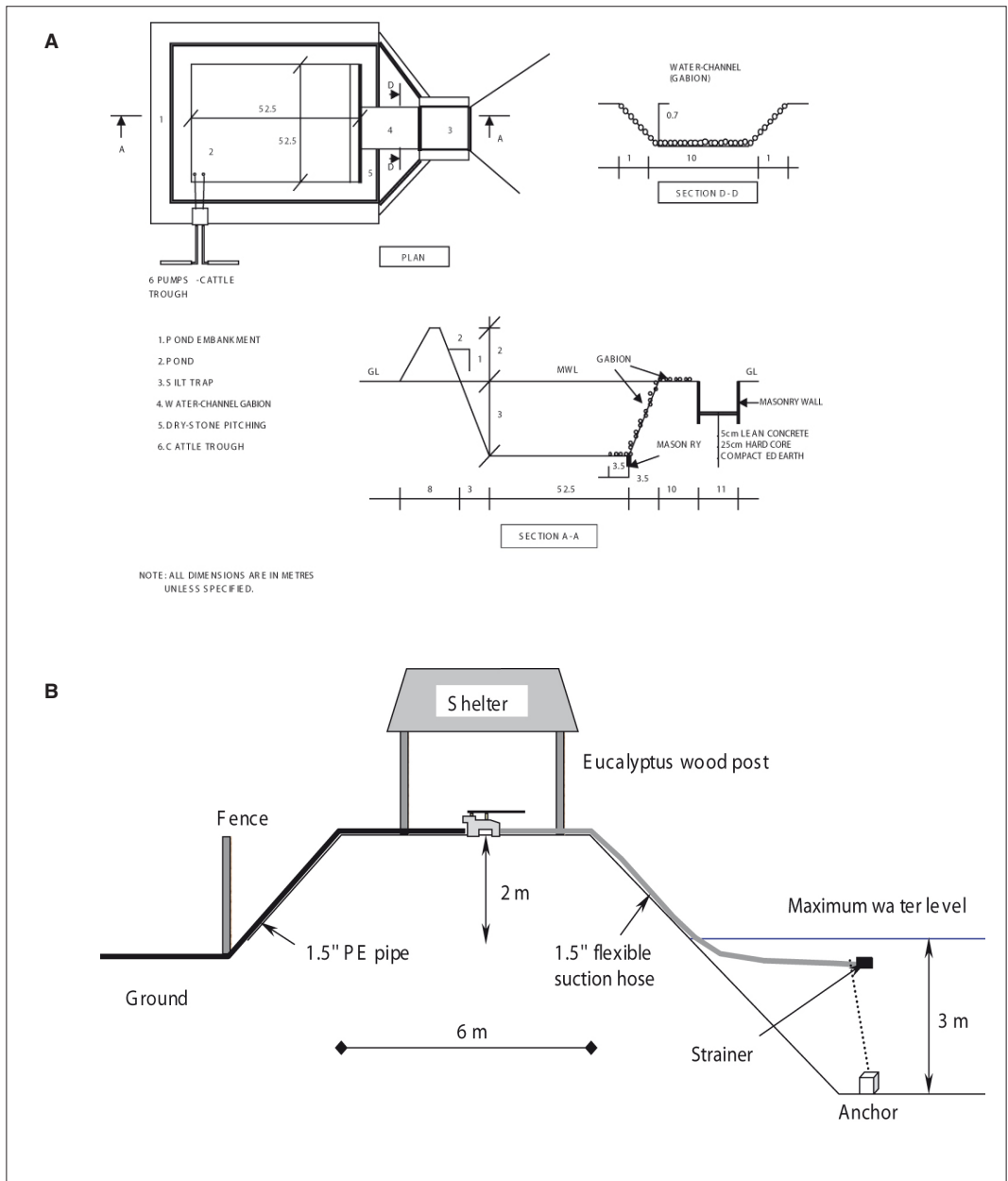


B



**Figure 19.2: Run-off water pond in Ethiopia.**  
**A:** aerial view of pastoral pond. **B:** birkad.

Erosion is also a factor reducing sustainability. It causes damage to the pond and mud-pit banks, and scouring of the catchment area and consequently sitting-up of the pond. To solve this problem, ACF Ethiopia decided to place gabions in the mud pit and in the entrance channel, as presented in Figure 19.3A. Erosion is also due to the animals themselves, when they enter in the pond to drink. Installing a fence around the pond, as well as a proper system for watering animals, will allow the reduction of both erosion and sedimentation and will also protect the water from contamination.



**Figure 19.3: Pastoral pond (ACF Ethiopia, 2004).**  
A: plans. B: water-collection system.

Figure 19.3B shows a foot-pump system that can be installed on the edge of a pond in order to pump water into cattle troughs built beside it. These pumps are robust and easy to maintain, and pump high yields with little effort. The only disadvantage is that they must be primed with water. Experience shows that even simple pumps often present problems of maintenance in these contexts. If such a pumping system is considered too sophisticated for local capacities, an efficient and simple solution to limit erosion and water contamination is to delimit and fence off a dedicated and direct access for watering animals at a corner of the pond, or constructing a reservoir directly connected to the pond with a channel.

It is usually difficult to ensure the safety of drinking water with these ponds, but filtration systems (see Section 4) can improve water quality. Obviously such systems need maintenance and cannot be sustained in remote areas.

*Note.* – When building a pastoral pond in a wet-season grazing area (i.e. an area grazed only during and just after the rainy season, where no settlements exist), the pond should be designed not to last too long in the dry season. If the water remains too long during the dry season there is a risk that people will change their customs with the following potential negative consequences:

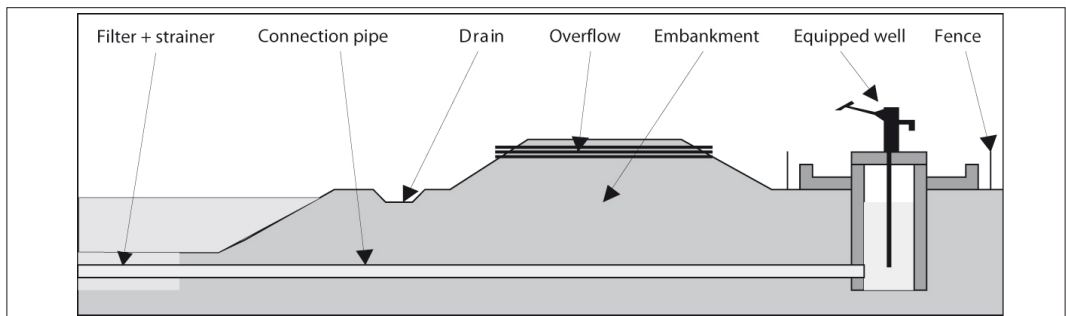
- people can be stuck in the wet-season grazing area without the possibility of reaching dry-season grazing areas safely (no more water along transhumance routes);
- people create new settlement areas (not always negative, but the consequences must be carefully studied);
- over-grazing is encouraged, reducing the time allowed for pasture regeneration, leading to the destruction of grazing reserves.

## 4 Examples of water-collection systems

### 4.1 Well beside the pond

When water is to be used for drinking, the pond must be protected from any external contamination. One solution is the construction of a well connected to the pond and equipped with a hand pump, as presented in Figure 19.4.

This system can guarantee access to water of acceptable quality only in the case of impluvium ponds and if access to the pond is prevented by a fence, to limit any risk of external contamination. As the well functions as a water-storage tank, the system remains safe only if water is collected on a regular basis, i.e. throughout the year, otherwise water will be stagnant and favourable to bacteriological development. A filter should be installed at the intake in the pond, in order to prevent the pipe from blocking. This is the weak point of the system and special attention must be paid in order to avoid blockages. Another solution is to connect the well to the pond with a filtration trench. This permits effective filtration of the water but the risk of blockage is higher.



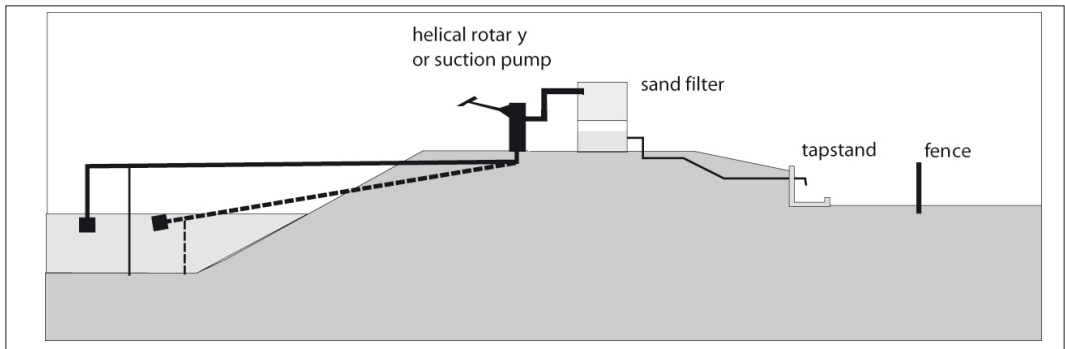
**Figure 19.4: Well connected to pond.**

## 4.2 Filtration

Another option, when water is to be used for drinking, is to filter the water before its supply via tapstands (see Figure 19.5). For information on sand filters, see Chapter 12, Section 2.5.

Two kinds of pump can normally be used: suction pumps or helical rotary pumps (see Chapter 9, Section 8.4). The intake can be fixed, or equipped with a floating system in order to follow the water level and pump the water from near the surface, to take advantage of the disinfecting action of UV radiation.

This system is particularly efficient in impluvium ponds but can also be used for run-off ponds. In any case this solution requires a significant level of community management in order to maintain, clean and operate the pump, the filter and the tapstands.



**Figure 19.5:** Filtration system.

# Annexes





I

# Programme development

# Reference indicators

<b>1</b>	<b>Water and sanitation guiding indicators depending on the situation</b>	<b>639</b>	<b>3</b>	<b>Planning guidelines for minimum numbers of toilets at public places and institutions in disaster situations (Sphere 2004)</b>	<b>641</b>
<b>2</b>	<b>Planning guidelines for minimum water quantities for institutions and other uses (Sphere 2004)</b>	<b>640</b>	<b>4</b>	<b>Guiding indicators linked to food security</b>	<b>641</b>

These tables show some guiding indicators for water and sanitation. The reference for stable situations must be the national standards. As it is difficult to determine reference indicators for all contexts, those included in the tables are only some examples chosen from some programmes.

## 1 Water and sanitation guiding indicators depending on the situation

	Emergency	Stable situation
Minimum quantity for human consumption (drinking + cooking + hygiene)	15 litres/person/day	National standard 30 - 60 litres/person/day
Nutrition centres	30 litres/patient/day	50 - 220 litres/patient/day
Health centres	50 litres/patient/day	
Maximum distance from water point	500 metres	50 metres
Number of people per water point	15 litres person/day 8 hours of supply: – 500 people per handpump (16.6 l/min.) – 400 people per open well (12.5 l/min.) – 250 people per 3/4" tap (7.5 l/min.)	50 litres person/day hours of supply – 150 people per handpump (16.6 l/min.) – 120 people per open well (12.5 l/min.) 75 people per tap (7.5 l/min.) Household connection
Maximum waiting time	15 minutes	No waiting time, or few minutes
Water quality	0 coliforms / 100 ml	
	Sanitation survey indicates a low risk of possible faecal contamination	
	For populations of more that 10 000 people, in locations where there is a high risk of epidemics, or where there is a high occurrence of diarrhoeas, <i>it is recommended to chlorinate the water</i> and ensure a residual chlorine level of 0.5 mg per litre and less than 5 NTU turbidity	

	Emergency	Stable situation
Water quality	<p>For physico-chemical parameters, use the WHO guideline values and assess the danger of consuming the water for a short period (in emergencies), thus opening up the possibility of using other water sources. If the danger is deemed very high, the water should not be used</p> <p>Total dissolved solids should not exceed 1 000 mg/litre, or a conductivity of 2 000 µs/cm</p> <p>In order to avoid negative health effects, the water should not contain chemical or radioactive contamination</p>	
Defecation areas	At least 50 m away from the nearest water point Trenches: 2.5 m x 0.3 m x 1 m for 100 people	No defecation areas
Latrines	<p>First phase: 1 public latrine per 50 people</p> <p>Second phase: 1 public latrine used per 20 people</p> <p>Third phase: 1 family latrine used per family</p>	1 latrine per family
Access to latrines	<p>More than 50 m from the nearest water point</p> <p>Less than 50 m from the house</p>	

## 2 Planning guidelines for minimum water quantities for institutions and other uses (Sphere 2004)

Health centres and hospitals	<p>5 litres/outpatient</p> <p>40-60 litres/inpatient/day</p> <p>Additional quantities may be needed for laundry equipment, flushing toilets etc.</p>
Cholera centres	<p>60 litres/patient/day</p> <p>15 litres/carer/day</p>
Therapeutic feeding centres	<p>30 litres/inpatient/day</p> <p>15 litres/carer/day</p>
Schools	<p>3 litres/pupil/day for drinking and hand-washing (use for toilets not included: see below)</p>
Mosques	2-5 litres/person/day for washing and drinking
Public toilets	<p>1-2 litres/user/day for hand-washing</p> <p>2-8 litres/cubicle/day for toilet cleaning</p> <p>All flushing toilets 20-40 litres/user/day for conventional flushing toilets connected to a sewer</p> <p>3-5 litres/user/day for pour-flush toilets</p> <p>Anal washing 1-2 litres/person/day</p>
Livestock	<p>20-30 litres/large or medium animal/day</p> <p>5 litres/small animal/day</p>
Small-scale irrigation	3-6mm/m <sup>2</sup> /day, but can vary considerably

### 3 Planning guidelines for minimum numbers of toilets at public places and institutions in disaster situations (Sphere 2004)

Source: Sphere Project, 2004 (adapted from Harvey, Baghri & Reed 2002).

Institution	Short term	Long term
Market areas	1 toilet to 50 stalls	1 toilet to 20 stalls
Hospital/Medical centres	1 toilet to 50 outpatients	1 toilet to 20 outpatients
Feeding centres	1 toilet to 20 child	1 toilet to 10 child
Reception and transit centres	1 toilet per 50 people 3:1 female to male	
Schools	1 toilet to 30 girls 1 toilet to 60 boys	
Offices	1 toilet to 20 staff	

### 4 Guiding indicators linked to food security

**Table I: Water quantity requirements.**

Kitchen gardens	Depends on the type of plant, but as a minimum guideline: 5 litres/m <sup>2</sup> /day
Small animals* (goats and sheep)	5 litres/head/day
Large animals*	
– donkeys	20 litres/head/day
– cows	30 litres/head/day
– camels	40 litres/head/day

\* In tropical and semi-tropical countries, a standard unit, equivalent to a cow of 250 kg, the Tropical Livestock Unit (TLU), is used. This unit is used as a reference for all animals with the following ratio:

- cows and horses: 1 TLU
- donkeys: 0.4 TLU
- sheep and goats: 0.2 TLU
- camels: 1.2 – 2 TLU

**Table II: Recommended microbiological quality guidelines for wastewater use in agriculture<sup>1</sup>**  
**(from Cairncross & Feachem 1983, *Environmental health engineering in the tropics*).**

Category	Reuse conditions	Exposed group	Intestinal nematodes <sup>2</sup> (arithmetic mean <sup>3</sup> no. of eggs per litre)	Faecal coliforms (geometric mean <sup>3</sup> no. per 100 ml)	Wastewater treatment expected to achieve the required microbiological quality
A	Irrigation of crops likely to be eaten uncooked, sports fields, public parks <sup>4</sup>	Workers, consumers, public	No more than 1	No more than 1000 <sup>4</sup>	A series of stabilisation ponds designed to achieve the microbiological quality indicated, or equivalent treatment
B	Irrigation of cereal crops, industrial crops, pastures and trees <sup>5</sup>	Workers	No more than 1	No standard	Retention in stabilisation ponds recommended for 8 – 10 days or equivalent helminth and faecal coliform removal
C	Localised irrigation of crops in category B but only if exposure of worker and the public does not occur	None	Not applicable	Not applicable	Pre-treatment as required by irrigation technology, but not less than primary sedimentation

1. In each specific case, local epidemiological, socio-cultural and environmental factors should be taken into account, and the guidelines modified accordingly.

2. *Ascaris* and *Trichuris* species and hookworms.

3. During the irrigation period.

4. A more stringent guideline (no more than 200 faecal coliforms per 100 ml) is appropriated for public lawns, such as hotel lawns, with which the public may come into direct contact.

5. In the case of fruit trees, irrigation should cease two weeks before fruit is picked, and no fruit should be picked off the ground. Sprinkler irrigation should not be used.

# Calculation of indicators

<b>1</b>	<b>Calculation of general indicators</b>	<b>643</b>	<b>2</b>	<b>Calculation of specific indicators for water and sanitation</b>	<b>647</b>
1.1	Estimation of population	643	2.1	Quantity of water available and water consumption	647
1.2	Mortality	644	2.2	Access to water point	648
1.3	Morbidity	645	2.3	Water quality	648
1.4	Nutritional status	645	2.4	Sanitation	649

## 1 Calculation of general indicators

### 1.1 Estimation of population

If there is no reliable information regarding population figures, it is possible to estimate this in an approximate manner. There are two main possibilities:

1) Select three random areas 100 metres by 100 meters. Count the population of each area and to calculate the average. Estimate the population of all the area by applying this average to the whole area of the settlement.

Example: total area of settlement 6 km<sup>2</sup>:

– area A: 100 people,

– area B: 150 people,

– area C: 180 people,

Average: 143 people.

Estimation for all the area:  $(143 \text{ people} / 0.01 \text{ km}^2) \times 6 \text{ km}^2 : 86 \text{ 000 people}$ .

2) Estimate the average number of people in a family (average of 20 families selected by random) and families living in each house. Count the houses and estimate the population. If the population is high it is possible to extrapolate smaller representative areas.

### INDICATORS FOR AGE-DISTRIBUTION OF POPULATION (AS A PERCENTAGE OF THE TOTAL POPULATION)

Age (year)	Africa (%)	Latin America (%)	Asia (%)
< 1	4	3	3
1-4	13	10	12
5-14	27	24	26
15-44	42	45	44
> 45	14	18	16

Sex distribution is around 50:50.

## 1.2 Mortality

Mortality can change quickly, normally it is estimated for 1 day, 1 week or 1 month. There are several indicators, but the more commonly used are the crude mortality rate (related to all the population) and the under-five specific mortality rate. Mortality can be also calculated for specific causes (cause-specific mortality rate).

It is important to do an interpretation by proper analysis and information exchange with the health system (verifying the sources and accuracy of mortality data and the population break-down). Interpretation must also identify trends and look for causes.

### INDICATORS

- Crude mortality rate (CMR) = total number of deaths reported over a given period of time, per estimated mid-period population. Commonly expressed in number per 10 000 people per day in emergencies.
- Under-five specific mortality rate (U5MR) = number of under-five deaths reported over a given period of time, per estimated mid-period under-five population. Commonly expressed in number per 10 000 per day in emergencies.
- Cause-specific mortality rate = number of deaths attributed to a specific cause over a period of time, per estimated mid-period population. Commonly expressed in number per 10 000 per day in emergencies.
- Case fatality rate = number of deaths per number of cases of the disease in question. Commonly expressed as a percentage.

### MORTALITY RATE CALCULATION

- Count the deaths every day during 1 week and calculate the average.
- Mortality rate:  $(\text{number of deaths} \times 10\,000) / (\text{number of days} \times \text{population}) = \text{number of deaths} / 10\,000 \text{ people} / \text{day}$ .
- Mortality rates for specific groups (e.g. under-fives) or by specific causes: the same formula but only considering the deaths and groups directly concerned.

### MORTALITY RATES AS INDICATORS OF THE SERIOUSNESS OF A SITUATION IN DEVELOPING COUNTRIES

Crude mortality rate	Situation	<5 Mortality rate
0.5 / 10 000 / day	Normal	<1 / 10 000 / day
<1.0 / 10 000 / day	Under control	<2 / 10 000 / day
(1 – 2) / 10 000 / day	Serious situation*	(2 - 4) / 10 000 / day
>2 / 10 000 / day	Out of control**	>4 / 10 000 / day
>5 / 10 000 / day	Catastrophic	>10 / 10 000 / day

\* Alert cut-off.

\*\* Emergency cut-off.

These thresholds have to be used with caution and in relation with contextual analysis. Trend analysis is also recommended to follow a situation: if nutrition and/or mortality indicators are deteriorating over time, even if not above threshold rates, this indicates a worsening situation.



### 1.3 Morbidity

Disease patterns are assessed by:

- Discussion with health workers from the affected population and host health-care services; this may be a way getting qualitative information.
- Direct observation by medical staff; this is useful for assessing the presence of certain health problems, such as measles.
- Retrospective sample surveys when quantitative data is needed on the incidence of diseases over a period of time.

#### INDICATORS

- Incidence: number of new cases of a specified disease reported over a given period of time, per estimated mid-period population at risk. Commonly expressed as new cases per 100 per month, or per 1 000 per week in emergencies.
- Prevalence: number of current cases, new and old – of a specific disease at a given point in time, per population at risk at the same point in time. Commonly expressed as a percentage.
- Attack rate: number of new cases of a specified disease reported over the duration of an epidemic, per estimated total population at risk over the same period. Commonly expressed as a percentage.

### 1.4 Nutritional status

A prevalence of acute malnutrition between 5-8% indicates a worrying nutritional situation, and a prevalence greater than 10% corresponds to a serious nutrition situation (Standing Committee of Nutrition, United Nations System, 1995)

	Global acute malnutrition (%)	Severe acute malnutrition (%)
Normal	< 5	< 1
Under control	< 10	< 2
Out of control	> 10	> 2
Catastrophic	> 20	> 5

#### CALCULATION OF THE INDICATORS

Nutritional status can be evaluated using clinical, anthropometric or biological measurements. In field conditions, anthropometric measurements and the presence of oedema are the indicators generally used.

The anthropometric measurements most commonly used are:

- weight;
- height;
- mid-upper arm circumference (MUAC).

Weight and height on their own reveal little about nutritional status. They must be used in conjunction with each other or with reference to age, to establish anthropometric indices. The presence of bilateral oedema is considered to be characteristic of Kwashiorkor.

#### ACUTE MALNUTRITION (FOR 6 – 59 MONTHS)

The two symptoms of acute malnutrition are a low weight-for-height index and the presence of bilateral oedema. Malnutrition is classed as either severe or moderate according to the weight-for-height index figure.

### *Severe acute malnutrition*

- Weight-height index < 70 % of the median (or < - 3 Z-scores).
- And/or presence of bilateral œdema (If œdema is present the individual is diagnosed as severely malnourished, regardless of the weight-for-height index figure).

### *Moderate acute malnutrition*

- Weight-height index  $\geq$  70 % and < 80% of the median (or  $\geq$  - 3 Z-scores and < - 2 Z-scores).

### *Global acute malnutrition (total of malnourished individuals)*

- Weight-height < 80% of the median (or < - 2 Z-scores).
- And/or presence of bilateral œdema.

Among children presenting œdema, a distinction may be made according to the weight-height index figure.

### *Kwashiorkor*

- Presence of œdema and weight-height index  $\geq$  80% of the median (or  $\geq$  - 2 Z-score).

### *Marasmic-Kwashiorkor*

- Presence of œdema and weight-height index < 80% of the median ( or < - 2 Z-scores).

## USING MUAC

There is no internationally recognised threshold for the classification of malnutrition according to MUAC. ACF uses the following thresholds, for children aged from 6 to 59 months.

MUAC	Diagnosis
< 110 mm	Severe malnutrition
$\geq$ 110 and < 120 mm	Moderate malnutrition
$\geq$ 120 and < 125 mm	Serious risk of malnutrition
$\geq$ 125 and < 135 mm	Moderate risk of malnutrition
$\geq$ 135	Satisfactory nutritional status

For more information, please refer to *Assessment and treatment of malnutrition in emergency situations*, Action contre la Faim, 2002.

## FOOD-SECURITY INDICATORS

In terms of food security, it is important to distinguish whether people are able to produce most of the components of their daily diet (cereals, meat, fish, vegetables etc), or whether they need to buy most of their food. The indicators presented below are classified following this logic, and apply to rural areas, where ACF commonly works.

There are no specific reference values that can be used to define general indicators for assessing food security in all possible contexts; the different socio-economic and agro-economic contexts influence the reference values and have to be considered, which is why the list of potential indicators shown here should be adapted to each specific context where they are to be applied.

Data relating to the following food security indicators could be compared with the reference data of a normal year in each context, unlike water and sanitation and nutrition indicators, that are compared to standard reference values.

### 1) *Key indicators for food producers*

- Size of private farms: Ha of arable land/family.
- Number of crops per family: fewer different crops = more external risks for production.

- Kind of crops: staple crops (main components of the diet), cereals, cash crops etc.
- Production: yield/Ha.
- Market – subsistence ratio: kg sold/kg produced.
- Livestock: Number of head/family.

2) *Key indicators for people who need to work off the farm*

- Household assets: value, productive assets (land, machinery) and non-productive assets.
- Average incomes of the whole family per month.
- Number of active members/family.

3) *Key indicators for both groups*

- Economic security, measured by access to the basic food basket in the specific context: total family incomes/total price of the basic food basket.
- Food security:
  - number of meals/person/day,
  - number of different components of the dish,
  - number of months per year without access to a normal diet.

## 2 Calculation of specific indicators for water and sanitation

### 2.1 Quantity of water available and water consumption

#### INDICATOR 1: NUMBER OF LITRES PER PERSON PER DAY.

- *Option 1*: water consumption through direct observation, estimation of consumption per family or person:
  - household survey;
  - verification of quantity of water taken per person at the water point (for example during 1 day).
- *Option 2*: water available through theoretical calculation: sum of capacity of supply of all the water point / total population. The capacity of supply depends on two factors:
  - capacity of the water point (calculation through yield tests);
  - capacity of supply of the water-abstraction system.

#### *Type of water point and capacity of supply*

- *Handpumps*: average yield is approximately 1 m<sup>3</sup> / hour, so with 8 hours of use this is 8 m<sup>3</sup> per day. A more precise yield can be calculated by measuring the time taken to fill a 200-litre drum and estimating the yield for 1 hour.
- *Electric pumps*: the hourly yield given by the characteristics of the pump can be multiplied by an estimate of the hours of use per day. Sometimes submersible pumps are overestimated with respect to the characteristics of the well, so it is important to verify the yield through direct observation (using a 200-litre drum).
- *Solar pumps and wind pumps*: the same procedure can be used as for electrical pumps but the variations due to changes in weather conditions must also be considered.
- *Springs*: there are several empirical methods used to calculate spring yield (see Chapter 10). The more common is to calculate the time taken to fill a known volume and estimate the yield for 1 hour. Take care with seasonal variations.
- *Distribution networks*: calculation of the total yield pumped (stored) per day.
- *Taps*: a 3.4“ tap with 10 m of head provides 0.2 to 0.3 litres per second (the same as a Talbot tap with 5 m of head).
- *Water trucking*: capacity of the tanker x number of trips.

INDICATOR 2: NUMBER OF PEOPLE PER TYPE OF WATER POINT (AS A REFERENCE TO CALCULATE THE QUANTITY OF WATER AVAILABLE PER PERSON PER DAY)

*Estimation*

- Theoretical: number of people / number of water points (same type).

*Reference indicators*

- 1 handpump can supply 500 people.
- 1 open well can supply to 400 people.
- 1 tap can supply to 250 people

INDICATOR 3: QUANTITY OF WATER AVAILABLE IN SPECIFIC PLACES (LITRES PER PERSON PER DAY)

See reference indicators in Annex 1.

## 2.2 Access to water point

- Indicator 1: distance from the home to the water point.
- Indicator 2: time required to arrive at the water point.
- Indicator 3: queuing time.

### REFERENCE INDICATORS

- Minimum distance: 500 metres (Sphere).
- Maximum time required to arrive: 1/4 hour (in difficult terrain).
- Maximum queuing time: 15 minutes (Sphere).

## 2.3 Water quality

See Chapter 4.

### INDICATOR 1: COLOUR, ODOUR AND TASTE. QUALITATIVE INDICATOR

### INDICATOR 2: NUMBER OF FAECAL COLIFORMS / 100 ML OF WATER (REFERENCE INDICATOR: 0 FAECAL COLIFORMS / 100 ML)

### INDICATOR 3: PHYSICOCHEMICAL PARAMETERS

- Reference indicators are the WHO guidelines for drinking-water quality.
- It is necessary to do the analysis of some specific parameters of concern for health when there is the following evidence:
  - The parameter of concern has previously been identified as a problem in the area.
  - The composition of geological formations can produce this contamination in the water.
  - There has been an accident or contamination event (a spill of pesticides, fertilizers etc.)
  - A disease related to a specific aspect of water quality is detected.

*Note* – There are other reasons not related to health to carry out physicochemical analysis: acceptance (test), possible damage to the water system (e.g. salty waters can accelerate the oxidation of iron pipes, and other material may be more appropriate) etc. For this reason, if time and resources are available, it is recommended to include the analysis of other parameters (major elements and toxic minerals) to characterise the water resources in the region.

## INDICATOR 4, DISINFECTION EFFICIENCY

- Residual free chlorine (mg/litre).
- Turbidity (NTU).

## 2.4 Sanitation

### EXCRETA DISPOSAL

- Indicator 1: public latrines: number of people using 1 latrine.
- Indicator 2: family latrines: % of families with latrines.

### HYGIENE FACILITIES

- Indicator 1: % of families with family showers and/or number of people per communal shower.
- Indicator 2: number of families per washing basin.
- Indicator 3: refuse collection, number of families per refuse bin.
- Indicator 4: weight of soap per person per month.
- Indicator 5: number and size of water containers per family.

### WATER MANAGEMENT

- Indicator 1: % of functioning water points.
- Indicator 2: number of repairs done during the previous year.
- Indicator 3: % of water points with functional water-management system.
- Indicator 4: availability of spare parts in the area.

# Sphere assessment checklist

<b>1</b>	<b>General</b>	651	<b>4</b>	<b>Vector-borne disease</b>	652
<b>2</b>	<b>Water supply</b>	651	<b>5</b>	<b>Solid waste disposal</b>	653
<b>3</b>	<b>Excreta disposal</b>	652	<b>6</b>	<b>Drainage</b>	653

## WATER AND SANITATION INITIAL NEEDS-ASSESSMENT CHECKLIST (SPHERE 2004)

This list of questions is primarily for use to assess needs, identify indigenous resources and describe local conditions. It does not include questions to determine external resources needed in addition to those immediately and locally available.

### 1 General

- How many people are affected and where are they? Disaggregate the data as far as possible by sex, age, disability etc.
- What are people's likely movements? What are the security factors for the people affected and for potential relief responses?
- What are the current or threatened water- and sanitation-related diseases? What are the extent and expected evolution of problems?
- Who are the key people to consult or contact?
- Who are the vulnerable people in the population and why?
- Is there equal access for all to existing facilities?
- What special security risks exist for women and girls?
- What water and sanitation practices were the population accustomed to before the emergency?

### 2 Water supply

- What is the current water source and who are the present users?
- How much water is available per person per day?
- What is the daily/weekly frequency of the water supply?
- Is the water available at the source sufficient for short-term and longer-term needs for all groups in the population?
- Are water collection points close enough to where people live? Are they safe?
- Is the current water supply reliable? How long will it last?
- Do people have enough water containers of the appropriate size and type?
- Is the water source contaminated or at risk of contamination (microbiological or chemical/radiological)?

- Is treatment necessary? Is treatment possible? What treatment is necessary?
- Is disinfection necessary, even if the supply is not contaminated?
- Are there alternative sources nearby?
- What traditional beliefs and practices relate to the collection, storage and use of water?
- Are there any obstacles to using available supplies?
- Is it possible to move the population if water sources are inadequate?
- Is it possible to tanker water if water sources are inadequate?
- What are the key hygiene issues related to water supply?
- Do people have the means to use water hygienically?

### 3 Excreta disposal

- What is the current defecation practice? If it is open defecation, is there a designated area? Is the area secure?
  - What are current beliefs and practices, including gender-specific practices, concerning excreta disposal?
    - Are there any existing facilities? If so, are they used, are they sufficient and are they operating successfully? Can they be extended or adapted?
      - Is the current defecation practice a threat to water supplies (surface or ground water) or living areas?
        - Do people wash their hands after defecation and before food preparation and eating? Are soap or other cleansing materials available?
          - Are people familiar with the construction and use of toilets?
          - What local materials are available for constructing toilets?
          - Are people prepared to use pit latrines, defecation fields, trenches etc.?
          - Is there sufficient space for defecation fields, pit latrines, toilets etc.?
          - What is the slope of the terrain?
          - What is the level of the groundwater table?
          - Are soil conditions suitable for on-site excreta disposal?
          - Do current excreta disposal arrangements encourage vectors?
          - Are there materials or water available for anal cleansing? How do people normally dispose of these materials?
            - How do women manage issues related to menstruation? Are there appropriate materials or facilities available for this?

### 4 Vector-borne disease

- What are the vector-borne disease risks and how serious are these risks?
- What traditional beliefs and practices relate to vectors and vector-borne disease? Are any of these either useful or harmful?
  - If vector-borne disease risks are high, do people at risk have access to individual protection?
  - Is it possible to make changes to the local environment (by drainage, scrub clearance, excreta disposal, refuse disposal etc.) to discourage vector breeding?
    - Is it necessary to control vectors by chemical means? What programmes, regulations and resources exist for vector control and the use of chemicals?
      - What information and safety precautions need to be provided to households?

## 5 Solid waste disposal

- Is solid waste a problem?
- How do people dispose of their waste? What type and quantity of solid waste is produced?
- Can solid waste be disposed of on-site, or does it need to be collected and disposed of off-site?
- What is the normal practice of solid waste disposal for the affected population?  
(compost/refuse pits? collection system? bins?)
- Are there medical facilities and activities producing waste? How is this being disposed of?  
Who is responsible?

## 6 Drainage

- Is there a drainage problem (e.g. flooding of dwellings or toilets, vector breeding sites, polluted water contaminating living areas or water supplies)?
- Is the soil prone to water logging?
- Do people have the means to protect their dwellings and toilets from local flooding?



# Project manager. Job description

**To:** Human Resources: Leonor Calvo  
 Desk Officer: Ricardo Domingos  
 Technical Officer: Elisabeth Lictévout

**Date:** 22 / 04 / 04

**From:** Eduardo Briones: (Country Director in Philippines)  
 David Michaud (Water and Sanitation Officer)

## JOB DESCRIPTION

**Title of position:** Water & sanitation project manager in Cotabato, Philippines.

**Starting date:** May 2004

**Duration:** 1 year

### Context of the intervention

Support to vulnerable communities affected by the conflict through improving their basic living conditions of life and through strengthening their capacities to react to crises.

**Country:** PHILIPPINES

**Base:** Cotabato

Projects & funding	Budget code Description proposal	Starting date	Ending	Global amount
	Uprooted 2	May 2004	30 November	???
	Uprooted 3	December 2004	?	(to prepare the proposal)

**Creation of position:** YES NO

**Estimated duration of hand over:** 1 week

**Name of replaced person:** David Michaud

**Dates:** 1 May to 7 May

**Next location of this person:** ???

**Planned date for departure:** after briefing

## ACTION AGAINST HUNGER PROGRAMME IN THE COUNTRY

Integrated programme (Food security, health and water and sanitation) in Lanao del Sur, Mindanao.

Vulnerability study in Mindanao.

Food Security project in Vigan.

Preparation of internal capacity to react to the crises through emergency responses.

Advocacy through the vulnerable populations in Mindanao.

## COMPOSITION OF THE COORDINATION TEAM

**Capital:** Manila

**Base 1:** Cotabato

Country director

1 head of base

Administrator

1 responsible for the vulnerability study

1 water and sanitation

1 food security

## DESCRIPTION OF THE PROJECT

---

### **Title:**

---

### **Programme type**

Integrated with food security and vulnerability observatory. Capacity building. Water, sanitation and hygiene.

---

### **Project objective**

To enhance the living conditions of 3,100 families affected by the conflict in rural areas of Maguindanao and Lanao del Sur provinces (Mindanao Island)

---

### **Specific objectives**

- 1) To strengthen the vulnerability observatory in order to consolidate the local capacities and the co-operation among local counterparts.
  - 2) To increase the copying mechanisms of the families living in Lanao del Sur and Maguindanao:
    - To ensure sustainable access to essential drugs.
    - To enhance local capacities in water and sanitation management in the 3 municipalities within Maguindanao and Lanao del Sur provinces.
    - To improve household food security.
- 

### **Results**

The good understanding of the local context of Maguindanao and Lanao del Sur provinces that is provided by the observatory improves the implementation and the impact of the projects that ACF and other agencies and institutions develop in these two provinces. As well it facilitates the provision of probable humanitarian crisis in the future in order to reduce their impact.

The communities' capacity is built for self-maintenance of the water system and sanitation facilities and improvement of their basic hygiene habits.

The local actors in water and sanitation (Municipalities, DPWH, DSWD, IPHO and communities) are involved and work together in the maintenance of the water and sanitation facilities as far as they have the necessary competencies in water and sanitation management.

Improved water access and quality (for drinking and personal hygiene purposes) and improved sanitation in Bala-bagan (4 barangays).

Agricultural income generating activities are expanded.

Most vulnerable households have re-capitalised in productive assets.

Community Based Marketing Organizations are created.

Incomes of families are increased and diversified.

---

### **Activities related to water and sanitation**

Reinforcement of the committees' and officials' capacities to maintain the public structures built during the first phase of uprooted (GFS, rain catchments and latrines).

Awareness of the community (in collaboration with the Health Department and Sanitary Inspector) to use and maintain their family latrines and to have better hygiene practices.

Hygiene promotion targeting children in school and among the community.

Socio-economic-cultural evaluation of the water and sanitation facilities provided during the first phase of uprooted.

Promotion of rain catchments at household level (or construction of family latrines depending on people's need).

Hygiene promotion focus on having rain water safe from contamination for drinking purpose and personal hygiene.

---

## DUTIES OF THE POST

**Staff management:** recruitment, planning, evaluation and training.

**Budget** (in coordination with administrator's team): Accountancy, budget monitoring, supply forecast.

**Logistic** (in coordination with logistics team): Stock management, equipment use and maintenance.

**Coordination and collaboration** with local authorities, national institutions, local NGO's, Universities etc.

**Capitalisation:** database management of all the project activities and analysis / Final report / Capitalisation of the mission.

**Methodology:** participative approach: involvement of all the people concerned by the project since the beginning in decision making, local capacity building, technology & management transfer.

**Respect of and participation** with national water supply & sanitation guidelines.

### The staff member will participate in:

Assesments:	YES	<del>NO</del>
Proposal making:	YES	<del>NO</del>
Budget drafting:	YES	<del>NO</del>

### In liaison with

HoM, Admin, Log, Technic.  
HoM, Admin, Log, Technic.  
HoM, Admin, Log, Technic.

### Frequency

As requested

### Reports

Monthly activity reports  
End of mission report  
Donor's report (intermediate and final)

### Frequency

Monthly

### Addressees

HOM, Tech. officer

### Number of persons to manage

Expatriate personnel: 0  
National staff: 10 people

### Specific duties

Recruitment & Job description: Yes  
Evaluations: Yes  
Training: Yes

### Frequency

## QUALIFICATIONS

### Academic level/Specific diploma/Specific knowledge required

Engineer degree, knowledge and mandatory experience in social approach of water and sanitation project, hygiene promotion, low cost water systems.

**Humanitarian experience necessary:** YES ~~NO~~

**Yes**, experience in community organizing (or community based approach) and hygiene promotion programmes are mandatory.

**Yes**, experience carrying out assessments and surveys for programme definition.

**Yes**, it is of vital importance for the Water and Sanitation Manager to have experience in a difficult context, including security management. High diplomatic skills are required to work in a complex environment characterised by:

- volatile and unpredictable security situation,
- traditional Muslim/non-Muslim communities,
- many governmental and non-governmental counterparts.

### Languages

French: NO	English: fluent	Spanish: N/A	Others:
spoken read written	spoken read written	spoken read written	spoken read written

## LIVING CONDITIONS

---

### 1) Breaks frequency

1 (one) long week-end per month and 1(one) week every 3 months, to be reconsidered based on stress management...

### 2) Lodging conditions

Guest house to be shared with other expatriates

### 3) Transport

By car or plane.

NB: Public transportation not allowed in Mindanao.

### 4) Cultural aspects (religion, behaviour, dressing etc.)

Religion in its variety is a very strong element in Filipino culture, therefore respect for other people's beliefs becomes mandatory. In Muslim Mindanao to wear short sleeves, shorts or tight clothes is not recommended to women when visiting authorities or during field visits.

Light casual clothes are recommended. Warmer garments are needed for mountain regions. On formal occasions, a dinner jacket and tie or the Philippine barong Tagalong may be worn. For daily work, you must care to be respectful to the rest of the staff, local counterparts and local authorities: you should avoid looking like a tourist.

Warmer clothes will also be useful in cinemas and long coach trips due to the excessive use of air conditioning.

### 5) Climate

The Philippines are hot and humid year-round. The weather pattern across the archipelago is complex, but can be roughly divided into the dry season (December to May) and the rainy season (June to November). The average annual temperature is 25 degrees Celsius. Keep in mind that the average humidity year-round is 77%!!

### 6) Leisure

Security context makes not easy to go out in Cotabato. However, it is en general possible some time to time to go to restaurants, use university sport installation.

---

## HISTORY OF THE MISSION

---

### PARTICULAR REMARKS

---

The project is taking place in 3 municipalities, in a total of 14 barangays (or villages). It takes from 1 to 2 hours to reach these places on a concrete road. Some of these barangays are only accessible by foot. The water and sanitation project can be briefly described in few words: community organizing, hygiene promotion and low-cost water supply at household level. Capacity building and training of the local team should be one of the major tasks. The expatriate should facilitate an ongoing process that involves the local team in all the project phase, including project definition, community approach and donors reports.

A new proposal is currently in process of preparation. If it is granted, the activities will be mainly the same but in another area of Central Mindanao (Liguasan marsh). It is proposed to work in 3 barangays. Consequently, the local team will increase in 6 persons.

Based in Cotabato city, regular field visits to the project area will be done if the security allows it. The unstable security context (up and down), especially inner part, could reduce temporally expatriates movements in the field. It means to continue working on a delegation process with the local staff (remote control). He/she should ensure a good coordination and communication among the water and sanitation team, and with the others departments, especially with the community organizer and logistic departments but also food security department, Administration and capital team.

---

# Water- and sanitation-related diseases

1	<b>Environmental classification of water-related infections</b>	659
2	<b>Environmental classification of excreta-related infections</b>	661
3	<b>General checklist of water-related and excreta-related diseases</b>	662

## 1 Environmental classification of water-related infections

Category	Infection	Pathogenic agent
1) FAECAL-ORAL (water-borne or water-washed)	Diarrhoeas and dysenteries – Amoebic dysentery – Balantidiasis – <i>Campylobacter</i> enteritis – Cholera – Cryptosporidiosis – <i>E. coli</i> diarrhoea – Giardiasis – Rotavirus diarrhoea – Salmonellosis – Shigellosis – Yersiniosis Enteric fevers – Typhoid – Paratyphoid Poliomyelitis Hepatitis A Leptospirosis Ascariasis Trichuriasis	Protozoon Protozoon Bacterium Bacterium Protozoon Bacterium Protozoon Virus Bacterium Bacterium Bacterium Bacterium Bacterium Bacterium Bacterium Bacterium Virus Virus Spirochaete Helminth Helminth
2) WATER-WASHED		
a) <i>Skin and eye</i> infections	Infectious skin diseases Infectious eye diseases	Miscellaneous Miscellaneous
b) <i>Other</i>	Louse-borne typhus Louse-borne relapsing fever	Rickettsia Spirochaete
3) WATER-BASED		
a) <i>Penetrating skin</i>	Schistosomiasis	Helminth
b) <i>Ingested</i>	Guinea worm Clonorchiasis Diphyllobothriasis Paragonimiasis Others	Helminth Helminth Helminth Helminth Helminth

Category	Infection	Pathogenic agent
4) WATER-RELATED INSECT VECTOR		
a) <i>Biting near water</i>	Sleeping sickness	Protozoon
b) <i>Breeding in water</i>	Filariasis	Helminth
	Malaria	Protozoon
	River blindness	Helminth
	Mosquito-borne viruses	
	– Yellow fever	Virus
	– Dengue	Virus
	– Others	Virus

## 2 Environmental classification of excreta-related infections

Category	Infection	Pathogenic agent	Dominant transmission mechanisms	Major control measures (engineering measures in italics)
1) FAECAL-ORAL (NON-BACTERIAL) Non-latent, low infectious dose	Poliomyelitis Hepatitis A Rotavirus diarrhoea Amoebic dysentery Giardiasis Balantidiasis Enterobiasis Hymenolepiasis	Virus Virus Virus Protozoon Protozoon Protozoon Helminth Helminth	Person to person contact Domestic contamination	<i>Domestic water supply</i> <i>Improved housing</i> <i>Provision of toilets</i> Health education
2) FAECAL-ORAL (BACTERIAL) Non-latent, medium or high infectious dose Moderately persistent and able to multiply	Diarrhoeas and dysenteries – <i>Campylobacter</i> enteritis – Cholera – <i>E. coli</i> diarrhoea – Salmonellosis – Shigellosis – Yersiniosis Enteric fevers – Typhoid – Paratyphoid	Bacterium Bacterium Bacterium Bacterium Bacterium Bacterium Bacterium Bacterium	Person to person contact Domestic contamination Water contamination Crop contamination	<i>Domestic water supply</i> <i>Improved housing</i> <i>Provision of toilets</i> <i>Excreta treatment prior to re-use or discharge</i> Health education
3) SOIL-TRANSMITTED HELMINTHS Latent and persistent with no intermediate host	Ascariasis (roundworm) Trichuriasis (whipworm) Hookworm Strongyloidiasis	Helminth Helminth Helminth Helminth	Yard contamination Ground contamination in communal defecation area Crop contamination	<i>Provision of toilets with clean floors</i> <i>Excreta treatment prior to land application</i>
4) BEEF AND PORK TAPEWORMS Latent and persistent with cow or pig intermediate host	Taeniasis	Helminth	Yard contamination Field contamination Fodder contamination	<i>Provision of toilets</i> <i>Excreta treatment prior to land application</i> Cooking and meat inspection
5) WATER-BASED HELMINTHS Latent and persistent with aquatic intermediate host(s)	Schistosomiasis Clonorchiasis Diphyllobothriasis Fasciolopsiasis Paragonimiasis	Helminth Helminth Helminth Helminth Helminth	Water contamination	<i>Provision of toilets</i> <i>Excreta treatment prior to discharge</i> <i>Control of animals harbouring infection</i> Cooking
6) EXCRETA-RELATED INSECT VECTORS	Filariasis (transmitted by <i>Culex pipiens</i> mosquitoes) Infections in categories I – IV, especially I and II, which may be transmitted by flies and cockroaches	Helminth Miscellaneous	Insects breed in various faecally contaminated sites	<i>Identification and elimination of potential breeding sites</i> Use of mosquito netting

### 3 General checklist of water-related and excreta-related diseases

Disease	Common name	Pathogen	Transmission	Distribution	Water-related category*	Excreta-related category**
<b>BACTERIAL DISEASES</b>						
Bacterial enteritis	Diarrhoea, gastroenteritis	<i>Campylobacter jejuni</i> <i>Escherichia coli</i> <i>Salmonella</i> spp. <i>Yersinia enterocolitica</i>	Faecal-oral, man-man or animal-man	Worldwide, particularly serious and common among children	1	2
Shigellosis	Bacillary dysentery	<i>Shigella</i> spp.	Faecal-oral, man-man	Worldwide	1	2
Cholera	Cholera	<i>Vibrio cholerae</i>	Faecal-oral, man-man	Worldwide	1	2
Paratyphoid	Paratyphoid	<i>Salmonella paratyphi</i>	Faecal-oral, man-man	Worldwide	1	2
Typhoid or enteric fever	Typhoid	<i>Salmonella typhi</i>	Faecal-oral, man-man	Worldwide	1	2
<b>SPIROCHAETAL DISEASES</b>						
Leptospirosis	Weil's disease	<i>Leptospira</i> spp.	Excreted by animals (notably rodents) in urine and infects humans through skin, mouth, or eyes, animal-man	Worldwide	1	—
Louse-borne relapsing fever		<i>Borrelia recurrentis</i>	Louse-borne, man-louse-man	Worldwide but mainly in poor mountainous parts of Africa, Asia and Latin America	2b	—
<b>VIRAL DISEASES</b>						
1) <i>Excreted viruses</i>						
Hepatitis A	Infectious hepatitis or jaundice	Hepatitis A virus	Faecal-oral, man-man	Worldwide	1	1
Poliomyelitis	Polio	Poliovirus	Faecal-oral, man-man	Worldwide	1	1
Viral diarrhoea	Diarrhoea	Rotavirus, Norwalk agent, other viruses	Faecal-oral, man-man	Worldwide	1	1
2) <i>Mosquito-borne viruses</i>						
Dengue	Breakbone fever	Dengue virus	Transmitted by mosquito <i>Aedes aegypti</i> & other <i>Aedes</i> + <i>Haemagogus</i> spp., man-mosquito-man	Dengue fever is now almost worldwide. A new serious form (dengue haemorrhagic fever) occurs mainly in the cities of S.E. Asia	4b	—



Disease	Common name	Pathogen	Transmission	Distribution	Water-related category*	Excreta-related category**
Yellow fever		Yellow fever virus	Transmitted by mosquito <i>Aedes aegypti</i> and other <i>Aedes</i> and <i>Haemagogus</i> spp., man or monkey-mosquito-man	Not reported from Asia or Australasia	4b	—
Other arboviral diseases		A large number of viruses causing various encephalitic and haemorrhagic infections	Mainly infections of animals and all transmitted by arthropods. Man infected accidentally by bites from mosquitoes (mainly), ticks, sandflies and midges	Worldwide	4b	—
<b>RICKETTSIAL DISEASE</b>						
Louse-borne typhus	Epidemic or classical typhus	<i>Rickettsia prowazeki</i>	Louse-borne, man-louse-man	Worldwide, but mainly in poor mountainous parts of Africa, Asia & Latin America	2b	—
<b>PROTOZOAL DISEASES</b>						
1) <i>Excreted protozoa</i>						
Amoebiasis	Amoebic dysentery	<i>Entamoeba histolytica</i>	Faecal-oral, man-man	Worldwide	1	1
Balantidiasis	Diarrhoea	<i>Balantidium coli</i>	Faecal-oral, man or pig-man	Worldwide	1	1
Cryptosporidiosis	Diarrhoea	<i>Cryptosporidium</i> spp.	Faecal-oral, man or animal-man	Worldwide	1	1
Giardiasis	Diarrhoea	<i>Giardia lamblia</i>	Faecal-oral, man-man	Worldwide	1	1
2) <i>Vector-borne protozoa</i>						
Malaria	Malaria	<i>Plasmodium</i> spp.	Transmitted by <i>Anopheles</i> mosquitoes, man-mosquito-man	Throughout most of the warmer parts of the world, although eradicated in some areas	4b	—
Trypanosomiasis (African)	Gambian sleeping sickness	<i>Trypanosoma gambiense</i>	Transmitted by riverine tsetse fly ( <i>Glossina</i> spp.), man-fly-man	Mainly West and Central Africa	4a	—
	Rhodesian sleeping sickness	<i>Trypanosoma rhodesiense</i>	Transmitted by game tsetse fly ( <i>Glossina</i> spp.), wild game or cattle-fly-man	Mainly East Africa	Not related to water or excreta (included for completeness)	
Trypanosomiasis (American)	Chaga's disease	<i>Trypanosoma cruzi</i>	Transmitted by bugs ( <i>Reduviidae</i> ), man or animal-bug-man	Latin America	Related to housing	

Disease	Common name	Pathogen	Transmission	Distribution	Water-related category*	Excreta-related category**
<b>HELMINTHIC DISEASES</b>						
<b>1) Excreted helminths</b>						
Ascariasis	Roundworm	<i>Ascaris lumbricoides</i>	Man-soil-man	Worldwide	—	3
Clonorchiasis	Chinese liver fluke	<i>Clonorchis sinensis</i>	Animal or man-aquatic snail-fish-man	S.E. Asia	3b	5
Diphyllobothriasis	Fish tapeworm	<i>Diphyllobothrium latum</i>	Man or animal-copepod-fish-man	Worldwide	3b	5
Enterobiasis	Pinworm	<i>Enterobius vermicularis</i>	Man-man	Worldwide	1	1
Fasciolopsiasis	Giant intestinal fluke	<i>Fasciolopsis buski</i>	Man or pig-aquatic snail-aquatic plant-man	S.E. Asia, mainly China	3b	5
Hymenolepiasis	Dwarf tapeworm	<i>Hymenolepis nana</i>	Man or rodent-man	Worldwide	1	1
Hookworm	Hookworm	<i>Ancylostoma duodenale</i> , <i>Necator americanus</i>	Man-soil-man	Mainly in warm, wet climates	—	3
Ophisthorchiasis	Cat liver fluke	<i>Ophisthorchis felineus</i> , <i>O. viverrini</i>	Cat or man-aquatic snail-fish-man	Thailand, former Soviet Union	3b	5
Paragonimiasis	Lung fluke	<i>Paragonimus westermani</i>	Pig, man, dog, cat or animal-aquatic snail-crab or crayfish-man	East Asia plus scattered foci in Africa and S. America	3b	5
Schistosomiasis	Bilharziasis	<i>Schistosoma haematobium</i>	Man-aquatic snail-man	Africa, Middle East and India	3a	5
		<i>S. mansoni</i>	Man-aquatic snail-man	Africa, Middle East and Latin America	3a	5
		<i>S. japonicum</i>	Animal or man-snail-man	S.E. Asia	3a	5
Strongyloidiasis	Threadworm	<i>Strongyloides stercoralis</i>	Man-soil-man	Mainly in warm, wet climates	—	3
Taeniasis	Beef tapeworm	<i>Taenia saginata</i>	Man-cow-man	Worldwide	—	4
	Pork tapeworm	<i>Taenia solium</i>	Man-pig-man	Worldwide	—	4
Trichuriasis	Whipworm	<i>Trichuris trichiura</i>	Man-soil-man	Worldwide	—	3
<b>2) Guinea worm</b>						
Dracunculiasis (dracontiasis)	Guinea worm	<i>Dracunculus medinensis</i>	Man-Cyclops-man	Africa, India	3b	—
<b>3) Mosquito-borne helminths</b>						
Filiariasis (Bancroftian)	May cause elephantiasis	<i>Wuchereria bancrofti</i>	Transmitted by mosquitoes, mainly <i>Culex pipiens</i> , <i>Anopheles</i> spp. and <i>Aedes</i> spp., man-mosquito-man	Worldwide	4b	6

Disease	Common name	Pathogen	Transmission	Distribution	Water-related category*	Excreta-related category**
Filariasis (Malayan)	May cause elephantiasis	<i>Brugia malayi</i>	Transmitted by mosquitoes, mainly <i>Mansonia</i> spp. and also <i>Anopheles</i> and <i>Aedes</i> spp., man-mosquito-man	India and S.E. Asia	4b	—
Loiasis		<i>Loa loa</i>	Transmitted by mangrove fly ( <i>Chrysops</i> spp.), man-fly-man	West and Central Africa	4b	—
Onchocerciasis	River blindness	<i>Onchocerca volvulus</i>	Transmitted by blackflies ( <i>Simulium</i> spp.), man-fly-man	Latin America, Africa and Yemen	4b	—

\* Related to Annex 5 Table 1.

\*\* Related to Annex 5 Table 2.



II

## Water resources

- Kunetz G (1966). *Principles of direct current resistivity prospecting*. Gebrüder Borntraeger, Berlin.
- Lachassagne P et al. (2001). Exploitation of high yields in hard-rock aquifers: downscaling methodology combining GIS and multicriteria analysis to delineate field prospecting zones. *Groundwater*, 39(4):568-582.
- Lencastre A (1995). *Hydraulique générale*. Eyrolles & Safege, Paris.
- Lubczynski M, Roy J (2003). *MRS contribution to hydrogeological parameterisation. MRS second international workshop*. BRGM, Orleans.
- Maher W (2003). *Drinking water quality*. SER.
- Meyer de Stadelhofen C (1991). *Applications de la géophysique aux recherches d'eau*. Lavoisier, Paris.
- Milsom J (1989). *Field Geophysics*. John Wiley & Sons, New York.
- Nelson KD (1985). *Design and construction of small earth dams*. Inkata Press, Melbourne.
- Pacey A, Cullis A (1986). *Rainwater harvesting: the collection of rainfall and runoff in rural areas*. IT Publications, London.
- Plote H (1986). *Sondage de reconnaissance hydrogéologique, méthode du MFT*. BRGM, Orléans.
- Pomerol A, Renard M (1997). *Éléments de géologie*. 11<sup>th</sup> ed. Masson, Paris.
- Réménieras G (1986). *L'hydrologie de l'ingénieur*. Editions Eyrolles, Paris.
- Robens Centre for Public and Environmental Health (2000). *OXFAM-DELAGUA portable water testing kit, users manual*. University of Surrey, Guildford.
- Rodier J (1996). *L'analyse de l'eau*. 8<sup>th</sup> ed. Dunod, Paris.
- Schneebeli G (1987). *Hydraulique souterraine*. Eyrolles, Paris.
- Travy Y (1988). *Hydrogéochimie et hydrogéologie des aquifères fluorés du bassin du Sénégal, origine et conditions de transport du fluor dans les eaux souterraines*. Research thesis. Université de Paris-Sud, Orsay, Paris.
- Université d'Avignon et des pays de Vaucluse (1990). *L'hydrogéologie de l'Afrique de l'ouest: synthèse des connaissances, socle cristallin et cristallophyllien en sédimentaire ancien*. 2<sup>nd</sup> ed. Collection maîtrise de l'eau. Ministère de la coopération et du développement, Paris.
- Vouillamoz J-M (2003). *La caractérisation des aquifères par une méthode non invasive: les sondages par résonance magnétique protonique*. Université de Paris XI, Orsay, Paris.
- Vouillamoz J-M et al. (2002). Application of integrated magnetic resonance sounding and resistivity methods for borehole implementation: a case study in Cambodia. *Journal of Applied Geophysics*, 50(1-2):67-81.
- Vouillamoz J-M et al. (2003). Localisation of saturated karst with magnetic resonance sounding and resistivity imagery. *Ground Water*, 41(5):578-587.
- Vouillamoz J-M, Chatenoux B (2001). *Apport de la géophysique à l'implantation de forages d'eau au Mozambique, méthodes électriques, TDEM et RMP*. Proceedings of 3<sup>rd</sup> Colloque GEOFCAN (51-54). INRA, Orléans.
- Vouillamoz J-M et al. (2003). *Magnetic Resonance Sounding: application to the characterisation of the crystalline basement aquifers of Burkina Faso*. Deuxième séminaire international sur la méthode de Résonance Magnétique des Protons appliquée à la recherche non invasive d'eau souterraine. BRGM, Orléans.
- WHO (2003). *Guidelines for drinking-water quality*. 3<sup>rd</sup> ed. Vol. I, recommendations. WHO, Geneva.
- Wright EPP et al. (1992). *The hydrogeology of crystalline basement in Africa*. Special Publication No 66. Geological Society, London.

## Water supply

- AFVP-GRET (1987). *Le captage des sources*. Dossier No 10. GRET, Paris.
- Ball C, Ball M (1991). *Water supplies for rural communities*. IT Publications, London.

# Hydrology

<b>1</b>	<b>Flows</b>	669	<i>2.1.3 Variations in stock</i>	676
1.1	Types of flow	669	<i>2.1.4 Estimation of recharge</i>	676
1.1.1	Pressured flow	669	2.2 Downstream approach	677
1.1.2	Flow in a porous environment	670	2.2.1 Estimation of outlets	677
1.2	Types of energy	670	2.2.1.1 Withdrawals	677
1.2.1	Pressured or free-surface flow	670	2.2.1.2 Springs and rivers	677
1.2.2	Porous environment	670	2.2.1.3 Other outlets	678
1.3	Bernouilli's theorem	671	2.2.2 Variations in stock	678
1.4	The continuity equation	671	2.2.3 Estimation of recharge	678
<b>2</b>	<b>Simplified hydrological balance</b>	672	<b>3 World meteorological data</b>	678
2.1	Upstream approach	672	3.1 January temperatures (°C)	678
2.1.1	Estimation of total flow	672	3.2 July temperatures (°C)	678
	2.1.1.1 Rainfall – temperature	672	3.3 Annual average precipitation (mm)	679
	2.1.1.2 Evapotranspiration	672	3.4 Solar radiation	
2.1.2	Estimation of inputs	675	on a horizontal surface (°C)	679
	2.1.2.1 Inputs	675		
	2.1.2.2 Useful precipitation	676		

## 1 Flows

### 1.1 Types of flow

If a liquid flow is in contact with the atmosphere, the flow is said to have a free surface, as in the case of an open irrigation channel, for example. If the flow takes place in a pipe, occupying the whole section and at a pressure higher than atmospheric, it is termed a pressurised flow. This is the case in water-distribution systems. If the liquid flows through a porous material, it is regarded as having flow in a porous environment.

If the characteristics of the flow at each point are independent of time, it is known as a permanent regime. Otherwise, the regime is called variable or transient.

When every particle of the liquid describes a well-defined trajectory, and has a velocity only in the direction of flow (parallel flow lines), the motion is laminar. When some particles of the liquid are in agitated motion due to velocities transverse to the flow, the motion is called turbulent.

#### 1.1.1 PRESSURISED FLOW

Turbulence is basically caused by viscosity, defined by Reynolds number ( $R_e$ ) as follows:

$$R_e = \frac{V.D}{\nu}$$

where  $V$  is the flow velocity (m/s),  $D$  the pipe diameter (m), and  $\nu$  the kinematic viscosity of the water (m<sup>2</sup>/s).

According to Carlier:

- when  $R_e < 2\,000$  the regime is laminar,
- when  $R_e > 2\,000$  the regime is turbulent.

The transition between the two regimes is not very clear, and there is often what is termed a 'transition zone'. In practice, and for water-supply systems, the regime is always turbulent.

### 1.1.2 FLOW IN A POROUS ENVIRONMENT

To define the flow in a porous environment the Reynolds number is used as follows:

$$R_e = \frac{V \cdot d}{\nu}$$

where  $R_e$  is the Reynolds number (non-dimensional),  $V$  the filtration speed (Darcy) in m/s,  $d$  the characteristic grain diameter, either  $d_{10}$  (De Marsily) or  $d_{50}$  (Lencastre) in m, and  $\nu$  the kinematic viscosity of water, in  $m^2/s$ .

According to De Marsily, flow in a porous environment is considered laminar when  $R_e < 10$ . Therefore, when  $R_e > 100$ , the flow is clearly turbulent (and Darcy's law is no longer valid). In practice, flow only becomes turbulent in a karstic environment, or in the immediate surroundings of a pumped well. De Marsily has proposed an empirical formula to estimate the transition from laminar to turbulent flow using the hydraulic gradient. It defines the gradient limits as  $i = 1/15 (K)^{1/2}$ .

To calculate  $R_e$ , the values of kinematic viscosity of the water depending on temperature are:

T(°C)	5	10	15	20	30
$\nu \cdot 10^6 (m^2/s)$	1.52	1.31	1.14	1.0006	0.8

## 1.2 Types of energy

Energy is defined as the product of force and displacement. In hydraulics, energy is usually related to the unit of weight, and designated in a simplified manner by load or height; in fact it has the dimension of a length (energy  $[m^2 \cdot kg \cdot s^{-2}] / \text{weight } [m \cdot kg \cdot s^{-2}] = [m]$ ).

A water particle travelling at velocity  $V$ , subject to a pressure  $p$ , and located at a height  $z$  above a horizontal plane of reference, possesses the following energy (Lencastre):

- potential energy:  $E_z = z$
- pressure energy:  $E_p = p / \omega$
- kinetic energy:  $E_k = V^2 / 2g$

where  $p$  is the relative pressure (relative to atmospheric),  $\omega$  the specific gravity of water,  $z$  the altitude of the water particle in relation to a reference line,  $V$  the velocity, and  $g$  the acceleration due to gravity.

Thus, the total energy, or total head, is:

$$E = z + \frac{p}{\omega} + \frac{V^2}{2g}$$

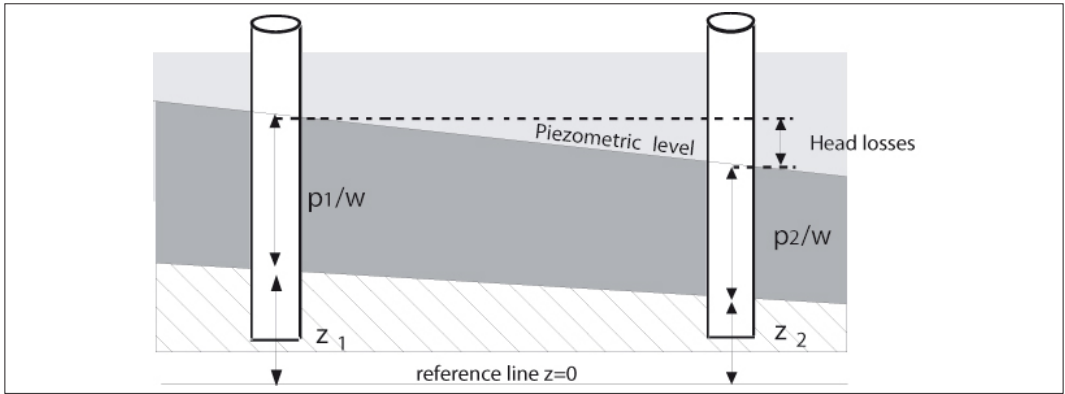
### 1.2.1 PRESSURISED OR FREE-SURFACE FLOW

This energy is usually represented graphically.

### 1.2.2 POROUS ENVIRONMENT

In a porous environment, flows usually travel very slowly. It is therefore considered that the dynamic head,  $E_k = V^2 / 2g$ , is negligible. For instance, a velocity of 1 cm/s, which would be quite a fast underground flow, gives a dynamic head of  $E_k = 1/1\,962 = 5$  microns.





**Figure 1: Flow in a porous environment.**

Therefore, the total head becomes  $E = z + p/\omega$ , and is called the static or piezometric head (Figure 1).

### 1.3 Bernouilli's theorem

Bernouilli's theorem is a direct result of the principle of conservation of energy in a permanent regime, for an incompressible fluid:

$$E = z + \frac{p}{\omega} + \frac{v^2}{2g} = \text{constant}$$

This principle produces a horizontal energy line for zero flow, and explains that the energy line falls due to head losses when a flow occurs. If the head losses ( $J$ ) are not neglected, the following can be written:

$$E + J = \text{constant}$$

Head losses correspond to the difference between the static and dynamic energy lines.

### 1.4 The continuity equation

In a cylindrical pipe, the flow  $Q$  is:

$$Q = V S = V \frac{\pi D^2}{4}$$

where  $Q$  is the flow ( $\text{m}^3/\text{s}$ ),  $V$  the velocity ( $\text{m}/\text{s}$ ),  $S$  the cross-sectional area of the pipe ( $\text{m}^2$ ), and  $D$  the interior diameter of the pipe ( $\text{m}$ ).

The continuity equation represents the physical principle of conservation of mass, and can be written in a simplified manner:

$$Q = V_1 S_1 = V_2 S_2$$

In other words, the flow that enters a pipe is equal to the flow that leaves it, whatever the changes in diameter or velocity.

## 2 Simplified hydrological balance

### 2.1 Upstream approach

The procedure is as follows:

- calculation of total flow: the total flow ( $E$ ), which corresponds to the surface flow (run-off), plus underground flow (useful precipitation,  $P_u$ ), is calculated from rainfall data;
- estimation of inputs ( $P_u + I_s$ ):  $P_u$  is estimated by establishing the proportions of the total flow as run-off and infiltration ( $P_u$ ). The other inputs ( $I_s$ ) are measured;
- estimation of changes in stock ( $\Delta S$ );
- calculation of recharge from the balance of the various terms.

#### 2.1.1 ESTIMATION OF TOTAL FLOW

The total flow ( $E$ ) is a fraction of precipitation. Part of the precipitation evaporates or is used by plants, and part becomes surface or underground flow.

##### 2.1.1.1 Rainfall - temperature

It is advisable to collect all available rainfall data and/or to install a network of rain gauges or pluviographs.

The density of the rain-gauge network is chosen according to the objectives, and environmental conditions. Within a climatic zone, rainfall depends on many different factors: altitude, exposition of side of valley, distance from the sea etc. In a restricted and relatively homogeneous area, such as some refugee camps, one or two rain gauges may be enough. At district level, the network must be more extensive to reflect the differences in the environment.

Temperature summaries are made with a minimax thermometer. The average temperature is calculated daily. These summaries are recorded on a measurement sheet prepared for the purpose.

The measurement sequence must be over as long a period as possible, ideally covering several years. However, the rain-gauge network should be installed as quickly as possible, because even though there may be no prospect of installing a more permanent network at the beginning of a programme, some ACF projects for wells and boreholes take place over periods of more than 3 or 4 years.

An automatic recording station for rainfall and temperature data can be installed to facilitate recording (ACF Somaliland, 1998).

A geographic representation is then assigned to each rain gauge. The standard methods are:

- arithmetic mean, the least accurate but easiest method;
- Thiessen's method (balancing by area), usable in fairly flat areas (Box 1);
- the isohyet method (linear variation proportional to distance), more accurate for hilly and mountainous relief.

Total rainfall estimated in this way feeds evapotranspiration and total flow.

##### 2.1.1.2 Evapotranspiration

Evapotranspiration is the fraction of water taken up by direct evaporation, and by the transpiration of plants. A large number of factors influence this parameter: temperature, wind, humidity, plant cover, solar radiation etc.

There are different methods for calculating evapotranspiration, but in ACF programmes only estimations from empirical formulas can be used.

The timescale used for calculation must be as small as possible, so as not to flatten out the variations excessively: periods of ten or thirty days are best, but formulas on an annual basis may be used in order to establish orders of magnitude.

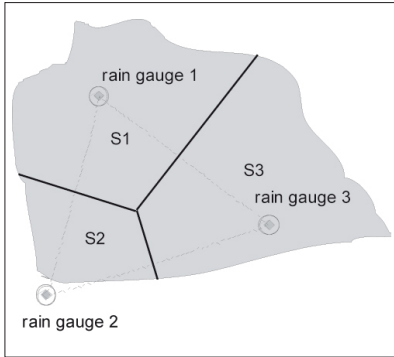
## Box 1

### Interpretation of point data.

#### Thiessen's method

This method is generally used for rainfall data. It assumes that the area covered by each rain gauge extends halfway to the next rain gauge. Over this area, rain is uniform and equal to the amount recorded by that particular rain gauge.

The geometry of the various areas is determined geometrically. Neighbouring rain gauges are connected by segments of a line, and then the mid-perpendiculars of these segments are drawn. Where they meet, they form polygons, each of which encloses a rain gauge. Polygons on the edge of a catchment basin follow its contour (Figure 1).



**Figure 1: Thiessen's method: weighting by area.**

Average rainfall in the basin is:

$$P = \frac{(\sum p_i S_i)}{S}$$

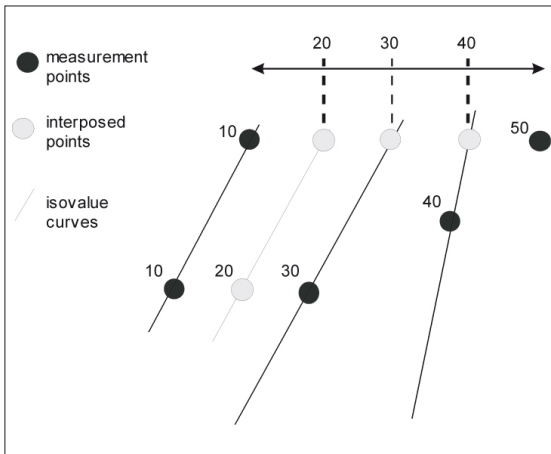
where P is the average rainfall for the whole basin (mm),  $p_i$  the rainfall recorded by rain gauge i (mm),  $S_i$  the area of the polygon enclosing rain gauge i ( $m^2$ ), and S the total area of the drainage basin ( $m^2$ ).

Thiessen's method should be used when there is a high density of rain gauges: then it is a weighting technique which is easy to use. On the other hand, it tends to give a larger weighting to isolated stations when the network is not dense. If these isolated stations are not representative of the catchment basin, a significant error in the total rainfall could be introduced.

#### Isovalue method

An isovalue curve is formed by all the points that present the same value of a given parameter (level, rainfall, conductivity etc.) for a given date or period of time. Thus, isopiezometric lines are curves of the same piezometric level, contours are curves of equal altitude, isohyets are curves of equal rainfall, isoconductivity curves join points of the same conductivity value etc.

This method assumes that between two neighbouring measurement points, the distribution of the parameter value is linear and directly proportional to the distance (Figure 2).



**Figure 2: Isovalue method: linear variations proportional to distance.**

When drawn by hand, isovalue curves help to take into account important features: surface water in the case of isopiezometric lines, relief or exposition in the case of isohyets etc. This is also possible when curves are drawn using software such as Surfer, but this requires painstaking input of parameters to modify the programme: if this adjustment is not carried out, the results can be erroneous. Therefore, it is generally better to draw curves by hand to integrate all the different features of the environment more quickly.

#### Measurement of area

It is often necessary to calculate areas from maps or diagrams, e.g. for calculation of the area of a catchment basin, Thiessen polygons, areas defined by curves etc.

The simplest method in the field is to draw or trace the areas to be calculated on squared paper and then count the squares, which is a time-consuming but effective method.

It is also possible to use a planimeter, which is a device that facilitates the measurement of areas, whatever their shape. It consists of an articulated arm, with one of its extremities fixed to a pedestal, and the other one supporting a view-finder and an area meter. The purchase of such a device is only justified if areas must be measured regularly.

Finally, images handled with certain software (Surfer, Mapinfo etc.) can also be processed by, for example, drawing polygons, which are then easy to measure.

In the formulas given in Box 2, a distinction is made between potential evapotranspiration (PET), and real evapotranspiration (RET). The potential evapotranspiration is always a maximum theoretical figure, assuming that the plant is in its optimum condition of transpiration capacity (especially that the plant has access to the required quantity of water to fully transpire).

When rainfall P, infiltration I, and real evapotranspiration (RET) are known, it is possible to calculate the total flow:

$$E = P - RET - I$$

## Box 2

### Calculation of RET.

#### *Thornthwaite balance method*

This method allows work at monthly or ten-days intervals. First, it is necessary to calculate the potential evapotranspiration (PET), which can be regarded as the evaporating power of the atmosphere. Then the real evapotranspiration (RET) is calculated, by comparing the PET and the available water resources for evaporation and transpiration. Even if potential evapotranspiration is high, water must be available to allow it to take place. This water availability is calculated from the 'easily usable reserve' (EUR). This is a theoretical reserve: it does not have a physical reality, even though the EUR could be regarded as the quantity of water stored in the first few metres of soil.

#### *Calculation of the monthly PET using Thornthwaite's formula*

$$PET = 1.6 \left( \frac{10t}{TE} \right)^a$$

where PET is the monthly potential evapotranspiration (cm), t the monthly average temperature (°C), TE the annual thermal index ( $TE = \sum_{i=1}^{12} i$ ), i the monthly thermal index [ $i = (t/5)^{1.514}$ ], and  $a = 0.016 TE + 0.5$  (Serra's simplified a).

This formula gives good results in maritime temperate climates (e.g. in Normandy, France), but underestimates the PET in hot dry climates by up to 30%.

#### *Calculation of the PET on a monthly or ten-day basis using Turc's formula*

$$PET = c \left( \frac{t}{t + 15} \right) (I_g + 50) b$$

where PET is monthly or ten-day potential evapotranspiration (mm), t the monthly or ten-day average temperature (°C),  $I_g$  the global solar radiation (cal/cm<sup>2</sup>/day),  $I_0$  the theoretical maximum radiation (cal/cm<sup>2</sup>/day), H the astronomical length of the day (h), and h the measured duration of sunshine (h).

– For the monthly PET, c is 0.40 for 30 and 31 day months, and 0.37 for February; for ten-day PET, c is 0.13.

– b is 1 if the average relative humidity of the atmosphere (rh) is greater than 50% (the most frequent case).

In desert climates,  $rh < 50\%$ , and  $b = [1 + (50 - rh)/70]$ .

– Parameters  $I_0$ , H, and h are tabulated:  $I_g = I_0 [0.18 + 0.62 (h/H)]$ .

Although it is more difficult to use than Thornthwaite's, this formula gives good results even in hot climates (in very hot climates, it still underestimates the RET, but by less than 10%).

#### *Thornthwaite balance*

This method compares the PET calculated by one of the two previous formulas with the rainfall and EUR, over a given period of time. The calculation principle must allow the rain first to feed the PET, then to complete the EUR up to its top level, and finally to feed surface run-off when the PET and the EUR have been satisfied. The following procedure must be followed:

## 2.1.2 ESTIMATION OF INPUTS

### 2.1.2.1 Inputs

The main input to the system is generally represented by useful precipitation, which is the fraction of rain that filters into the ground and that will therefore effectively contribute to the recharge of the aquifer. However, there are numerous other sources which can feed an aquifer: infiltration of surface water from rivers, lakes etc., other aquifers, leaks from irrigation channels etc. These sources can be indicated by piezometry, water chemistry (the simplest method being the use of a conductivity meter) and, of course, geology.

– if  $P + EUR \geq PET$ ,  $RET = PET$ ,  $EUR = P - RET$ , and  $E = P - (EUR + RET)$ ;

– if  $P + EUR < PET$ ,  $RET = PET - (P + EUR)$ ,  $EUR = P - RET$ , and  $E = 0$ ,

where  $P$  is the precipitation,  $PET$  the potential evapotranspiration,  $RET$  the real evapotranspiration,  $EUR$  the easily usable reserve, and  $E$  the flow (surface and underground). An example is given in Table I.

**Table I: Thornthwaite balance on a monthly basis with initial EUR of 100 mm.**

**P = precipitation (mm); EUR = easily usable reserve; PET = monthly potential evapotranspiration (mm); RET = real evapotranspiration (mm).**

	Jan	Feb	Mar	Apr	May	Jun	Jul	Aug	Sep	Oct	Nov	Dec	Total
P	100	90	80	70	60	50	50	60	70	80	90	100	900
EUR	100	100	100	86	35	0	0	0	0	8	54	100	
PET	34	40	61	84	111	138	156	140	105	72	44	32	
RET	34	40	61	84	111	85	50	60	70	72	44	32	743
E	66	50	19	0	0	0	0	0	0	0	0	22	157

The initial EUR must be chosen on the basis of geological and pedological contexts. The value EUR = 100 mm is generally adopted for contexts similar to those in which Thornthwaite developed his method: humid, moderate climate with cultivated land (eastern United States). For a soil which is not very suitable for storing water, the EUR can be decreased: in a karst context (Vaucluse fountain), Puig chose an EUR of 50 mm. The EUR value can be verified by comparing the actual annual flow value with the values calculated by Turc's and Coutagne's formulas.

*Calculation of the annual RET using Coutagne's formula*

$$RET = P - \lambda P^2$$

where  $RET$  is the real evapotranspiration (m),  $P$  the annual average precipitation (m),  $\lambda = 1/(0.8 + 0.14 T)$  if  $1/8 < P < 1/2$ ,  $T$  is the average annual temperature ( $^{\circ}C$ ).

If:

–  $1/8 > P$ , then  $RET$  is equal to precipitation, and therefore there is zero flow;

–  $P > 1/2$ , then  $RET$  is independent of precipitation, and is calculated by:

$$RET = 0.2 + 0.035 T$$

*Calculation of the annual RET using Turc's formula*

$$RET = \frac{P}{[0.9 + (P^2/L^2)]^{1/2}}$$

where  $RET$  is the real evapotranspiration (mm),  $P$  the annual average precipitation (mm),  $T$  the average annual temperature ( $^{\circ}C$ ), and  $L = 300 + 25T + 0.05T^3$ .

**Table I: Hydrogeological indexes calculated from annual data taken over several years (according to Castagny & BRGM).**

	Sedimentary zone (chalk, Hallue basin)	Bedrock zone (schists and granites, Burkina Faso)		
Average precipitation (mm/year)	740	513	807	1076
Average PET (mm/year)	514	310	446	674
Average E (mm/year)	226	203	361	402
Index (%)	92	67	61	66
Average P <sub>u</sub> (mm/year)	208	136	221	266
Surface flow average (mm/year)	18	67	140	136

The volume of these sources is calculated by Darcy's law, and by direct observation. However, the constraints involved in the implementation of humanitarian programmes do not always allow enough time to carry out these investigations. Therefore, only simple systems with easily quantifiable inputs can be studied.

#### 2.1.2.2 Useful precipitation

It is possible to establish a ratio between the portion of flow which becomes surface water and the portion which infiltrates. This ratio is based on the distributing power of the soil, calculated from the hydrogeological index (Table I).

It is essential to choose an index which corresponds to the conditions of the survey area. This choice is very tricky, and it greatly influences the results: it is therefore necessary to validate the result of the balance with that obtained using the hydrogeological method.

#### 2.1.3 VARIATIONS IN STOCK

The volume of water stored in the aquifer at any time  $t$  is given by the volume of the reservoir, and the useful porosity.

The volume of the reservoir is estimated from its area and depth. Its area is estimated from the geological map (topographic) and/or land surveys. Its power is known from the results of borehole drilling and geophysical studies.

Useful porosity (or the storage coefficient if the aquifer is confined) is calculated from the results of pumping tests.

Without doing this calculation, which is sometimes difficult to carry out in the field, simple piezometric monitoring over several years enables the changes in the stock of underground water ( $\Delta s$ ) to be measured. If variations are negligible, this term can be removed from the balance.

#### 2.1.4 ESTIMATION OF RECHARGE

Inputs have been quantified, and changes in stock evaluated. Now it is simple to calculate recharge from the expression for the balance:

$$\text{recharge} = P_u + I_s \pm \Delta s$$

where  $P_u$  is the useful precipitation ( $m^3/\text{year}$ ),  $I_s$  other sources ( $m^3/\text{year}$ ), and  $\Delta s$  the changes in stock of the aquifer ( $m^3/\text{year}$ ).

The example given in Table II represents a simplified balance, carried out in Corsica. Different values of EUR were tested: the EUR value = 50 mm was taken because the pedology of the site (little soil) allowed the assumption that the water storage potential of the soil accessible to plants was

**Table II: Simplified hydrogeological balance carried out in Corsica from rainfall data and monthly average temperatures (1961-1992).**

Calculation method for total flow		E (mm/year)	E (l/s/km <sup>2</sup> )				
Coutagne annual		97.2	3.1				
Turc annual		60.9	2				
Thornthwaite balance with Turc monthly PET		108.5	3.5				

Catchment basin	Area (km <sup>2</sup> )	Calculated total flow (balance)		Outlets		Inputs (P <sub>u</sub> = E-ESF) (m <sup>3</sup> /year)	Balance (m <sup>3</sup> /day) (non-exploited renewable resources P <sub>u</sub> -Q <sub>p</sub> )
		E (l/s/km <sup>2</sup> )	E (m <sup>3</sup> /year)	Estimated surface flow (m <sup>3</sup> /year)	Pumping Q <sub>p</sub> (m <sup>3</sup> /year)		
1	7.0	3.5	772 632	515 088	73 000	257 544	505
2	4.0	3.5	441 504	220 752	146 000	220 752	204
3	3.0	3.5	331 128	0	73 000	331 128	707
4	4.5	3.5	496 692	248 346	146 000	248 346	280
5	4.9	3.5	540 842	180 280	146 000	360 561	587
TOTAL	23.4	3.5	2 582 798	1 164 466	584 000	1 418 331	2 285

ESF = estimated surface flow.

low. Also, calculations carried out with a EUR of 50 mm gave flow values comparable to those calculated from annual formulas.

## 2.2 Downstream approach

The procedure is as follows:

- calculate outlets by estimating pumping withdrawals (Q<sub>p</sub>), and measure the underground flow (Q<sub>s</sub>) which feeds rivers and sources;
- assess change in the stock (s);
- estimate refilling from the computable balance of the various terms.

### 2.2.1 ESTIMATION OF OUTLETS

#### 2.2.1.1 Withdrawals

Sometimes, with motorised pumping, the pumped volume of water is recorded. If this is not the case, and for manual pumps, it can be calculated from the number of users, average daily use, and pumping flow. A handpump used intensively, for example for 6 h/day, can produce (6 h x 800 l/h), that is, 4.8 m<sup>3</sup>/day.

#### 2.2.1.2 Springs and rivers

The flow of springs and rivers fed by the aquifer corresponds to outlets from the system. It is therefore necessary to measure this flow, and to take it into account in the balance. However, this is often the balance term most difficult to obtain.

The flow of springs is measured at fixed times (on a monthly or ten-day basis).

Strictly speaking, it is essential to have a sufficiently long flow record to be able to calculate the base river flow, i.e. that generated by the aquifer flow, and not by surface run-off. In ACF programmes, such records are difficult to obtain. It can therefore be taken that the lowest flow level results only from the contribution of the aquifer (i.e. no rain and so no run-off).

### 2.2.1.3 Other outlets

Aquifer outlets to the sea, flow between different reservoirs etc., are difficult to measure in humanitarian programmes. Therefore, it is not possible to carry out balances on complex systems.

### 2.2.2 VARIATIONS IN STOCK

Variations are calculated in the same way as for the upstream approach (see Section 2.1).

### 2.2.3 ESTIMATION OF RECHARGE

The estimation results from the balance of the different terms:

$$\text{Recharge} = Q_s + Q_p \pm \Delta s$$

where  $Q_s$  is underground flow ( $\text{m}^3/\text{year}$ ),  $Q_p$  pumped flow ( $\text{m}^3/\text{year}$ ) and  $\Delta s$  the variations in stock ( $\text{m}^3/\text{year}$ ).

## 3 World meteorological data

### 3.1 January temperatures ( $^{\circ}\text{C}$ )

Latitude	Longitude																		
	105°W	90°W	75°W	60°W	45°W	30°W	15°W	0°	15°E	30°E	45°E	60°E	75°E	90°E	105°E	120°E	135°E	150°E	
30°N	12	16						13	10	12	8	6	16	17	16	8			
20°N	21	24	24					22	21	15	15	16	16	22	24			21	
10°N				22	23			24	22	22	22	24		27	20	26	21		
0°																			
10°S		22	26	23	25			23	23	25					20	26	26	27	
20°S		10	24	24	21				23	25	21						30	27	
30°S			26	23					23	22	22					27	32	31	

### 3.2 July temperatures ( $^{\circ}\text{C}$ )

Latitude	Longitude																		
	105°W	90°W	75°W	60°W	45°W	30°W	15°W	0°	15°E	30°E	45°E	60°E	75°E	90°E	105°E	120°E	135°E	150°E	
30°N																			
20°N	27	23						30	30	25	22	28	30	31	23	27			
10°N	21	20	21					27	27	27	28	29	27	28	24			27	
0°				21	23			24	22	23	27	27		32	27	24	28		
10°S		14	23	23	26			22	22	16				27	27	23	23		
20°S		10	16	21	16					15	13	20					25	14	
30°S			0	13						11	11	14				12	13	12	



### 3.3 Annual average precipitation (mm)

Latitude	Longitude																		
	105°W	90°W	75°W	60°W	45°W	30°W	15°W	0°	15°E	30°E	45°E	60°E	75°E	90°E	105°E	120°E	135°E	150°E	
30°N		500	1600					50	50	50	100	60	200	1500	2000	2200			
20°N		2000	2500	1200				400	200	200	100	70	400	1000	2500		3000		
10°N				2000	2500			2000	1700	1500	600	100		1000	4000	3000	3500		
0°																			
10°S			1000	2700	2000	700		1000	1500	700					4000	2000	2800	3000	
20°S			300	2200	2000	1000				600	700	1500						400	500
30°S				600	1500					300	600	1700				300	150	160	

### 3.4 Solar radiation on a horizontal surface (°C)

$$I_g = I_0 (0.18 + 0.62 h/H)$$

Global solar radiation  $I_g$  (also denoted  $R_g$ ) is given in cal/cm<sup>2</sup>/day, with 1 cal = 4.1855 J, and 1 cal/cm<sup>2</sup>/day = 0.011625 kWh/m<sup>2</sup>/day; h is the measured number of hours of sun per day, H the astronomical length of the day (astronomical day), and  $I_0$  the maximum theoretical radiation (cal/cm<sup>2</sup>/day), also known as  $I_{ga}$  or PSH (peak sun hours)

Values of H, length of the astronomical day (h)

Latitude North	30°	40°	50°	60°
January	10.45	9.71	8.58	6.78
February	11.09	10.64	10.07	9.11
March	12.00	11.96	11.90	11.81
April	12.90	13.26	13.77	14.61
May	13.71	14.39	15.46	17.18
June	14.07	14.96	16.33	18.73
July	13.85	14.68	15.86	17.97
August	13.21	13.72	14.49	15.58
September	12.36	12.46	12.63	12.89
October	11.45	11.15	10.77	10.14
November	10.67	10.00	9.08	7.58
December	10.23	9.39	8.15	6.30

Values of  $I_{ga}$  (kWh/m<sup>2</sup>/day) on a horizontal surface

Latitude North	30°	40°	50°	60°
January	5.9	4.2	2.6	1.0
February	7.3	5.8	4.2	2.5
March	8.9	7.8	6.5	5.0
April	10.2	9.7	8.8	7.9
May	11.0	11.0	10.7	10.2
June	11.3	11.5	11.4	11.3
July	11.1	11.1	10.9	10.6
August	10.4	10.0	9.3	8.5
September	9.2	8.3	7.1	5.7
October	7.6	6.2	4.7	3.0
November	6.1	4.5	2.9	1.3
December	5.5	3.8	2.1	0.6



# Water quality and analysis

## A INDICATORS NOT COVERED BY WHO

Several chemical elements are not covered by WHO guideline values, as their toxicity has not been established (phosphate, potassium, calcium, magnesium and others). In some countries these elements are subject to standards issued from national directives e.g. the AEP (*Alimentation en eau potable*) directives (1989) for France.

A humanitarian programme should conform to WHO guideline values, but a reference to national directives (which are broadly the same from one European country to another) may also be indicative.

### FRENCH AEP DIRECTIVES

Parameters	AEP Directives	Interpretation
Calcium (Ca <sup>2+</sup> )	Nil	O: rocks H: no direct problem, scaling (incrustation) in pipes
Magnesium (Mg <sup>2+</sup> )	50 mg/l	O: rocks (clays, basalt) H: bitter taste, laxative effect
Sodium (Na <sup>+</sup> )	150 mg/l	O: natural (Triassic context) H: laxative effect, pollution indicator
Hardness (Ca <sup>2+</sup> + Mg <sup>2+</sup> )	No standard	O: hardness = calcium and magnesium H: no problem; taste, furring when C > 200 mg/l
Phosphate (PO <sub>4</sub> , P <sub>2</sub> O <sub>5</sub> )	5 mg/l	O: organic matter, natural (calcic phosphates), faecal contamination, fertilisers, chemical industry, polyphosphates used against scaling, detergents H: detergent, fertiliser indicator, and faecal indicator
Potassium (K <sup>+</sup> )	12 mg/l K	O: fertiliser, rock leaching H: no problem, radioactivity from <sup>40</sup> K isotope
Oxidability	No standard	O: evidence of organic matter
Dissolved oxygen (O <sub>2</sub> )	No standard	O: atmospheric oxygen, photosynthesis H: no problem
pH	No standard	O: hydrogen ion H: significant parameter for treatment
Conductivity	No standard	O: matter in solution in the water H: acceptance

O: origin. H: health.

## B WATER POINT SANITARY SURVEY

<b>1</b>	<b>Sanitary inspection forms for different types of water point</b>	682	1.4	Water trucking	684
1.1	Groundwater: open well, well/borehole with handpump, well/borehole with motorised pump system	682	1.5	Piped supply	684
1.2	Protected spring	683	<b>2</b>	<b>Water quality form for different points in a water system</b>	685
1.3	Roof rainwater harvesting	683	<b>3</b>	<b>Risk analysis: assessment of priorities for remedial actions (selection of water points)</b>	685

### 1 Sanitary inspection forms for different types of water point

Adapted from WHO Guidelines for drinking-water quality, Volume 3, Annex 2.

Different sanitary inspection forms can be developed depending on the water system. Forms can be adapted to specific situations and contexts.

#### 1.1 Groundwater: open well, well/borehole with handpump, well/borehole with motorised pump system

	No	Yes	Recommended action
Is there a latrine or any source of pollution within 30 m of the well?			
Does the fence around the well allow animals in?			
Is the drainage channel less than 2 m long, broken or dirty?			
Is there stagnant water close to the well?			
Is the apron less than 1m wide all around the well?			
Are there any cracks in the well apron and headwall?			
Is the cover of the well unsanitary and closed?			
Is the well poorly sealed for 3 m below ground level?			
Is the water point dirty?			
Is the lift system in bad condition / are ropes and buckets dirty?			
<b>TOTAL SCORE OF RISK (number of "yes" points)</b>			

## 1.2 Protected spring

	No	Yes	Recommended action
Is there a latrine or any source of pollution within 30 m uphill of the spring?			
Does the fence around the spring allow animals in?			
Is the drainage channel blocking the flow and allowing stagnant water?			
Is the spring open to surface water contamination?			
Is the spring box cracked?			
Is the inspection cover cracked or unsanitary?			
Is the overflow pipe screen missing or unsanitary?			
Is the cut-off ditch above the spring blocked or non-existent?			
Is the water point dirty?			
Is there standing water at the collection point?			
TOTAL SCORE OF RISK (number of "yes" points)			

## 1.3 Roof rainwater harvesting

	No	Yes	Recommended action
Is the roof area dirty?			
Are the gutters that collect water dirty?			
Is there absence of a filter box at the tank inlet or is it not working well?			
Is there any other point of entry to the tank that is not properly covered?			
Are there cracks in the wall of the tank?			
Is the inside of the tank dirty or not periodically cleaned and disinfected?			
Are the taps leaking?			
Is the concrete apron near the tank absent or broken or dirty?			
Is the drainage in bad condition and the water inadequately drained?			
Is there any source of pollution around the tank or water collection area?			
TOTAL SCORE OF RISK (number of "yes" points)			

## 1.4 Water trucking

	No	Yes	Recommended action
Is the water point where the truck collects the water unsanitary?			
Is there no, or inadequate, chlorination of the water during the trucking process?			
Is the pipe used to fill and empty the water in the truck unsanitary or dirty?			
Is the tanker ever used for transporting other liquids besides drinking water?			
Is the filler hole of the truck unsanitary or is the lid missing?			
Are any parts of the system (water tank of the truck, storage tank in the community, distribution point) not periodically cleaned and disinfected?			
Is the storage tank / distribution point unsanitary and dirty?			
Is there no chlorination of the water at the storage tank / distribution point?			
Is the storage tank at the distribution point badly covered?			
Is there stagnant water around the water tank / distribution point?			
TOTAL SCORE OF RISK (number of "yes" points)			

## 1.5 Piped supply

	No	Yes	Recommended action
Is the source well protected?			
Is there any point of leakage between the source and the reservoir?			
Is there any point of leakage between the source and the reservoir?			
If there are any break-pressure tanks, are their covers unsanitary?			
Is the storage tank cracked or leaking and the inspection cover or the air vent unsanitary?			
Is the storage tank dirty or not regularly cleaned?			
Are there any leaks in the distribution system?			
Are the areas around the taps unfenced or allowing access to animals?			
Is there inadequate drainage and standing water around the taps?			
Are the surroundings of the taps dirty and with possible contamination sources (excreta, refuse etc.)?			
Is the water not chlorinated?			
TOTAL SCORE OF RISK (number of "yes" points)			

## 2 Water quality form for different points in a water system

Water quality information is also needed to do a proper analysis of the risks of contamination and disease transmission. Water quality analysis should be done at all points along the water system as shown in the form below.

Water point		General perception			Bacteriological		Other parameters outside WHO guideline values
		Colour	Odour	Taste	N° faecal coliforms /100 ml	Possible source of contamination	
Samples							
Part of the water system	Catchments Storage tank Distribution line Distribution point						
Family storage	Transport Household						

## 3 Risk analysis: assessment of priorities for remedial actions (selection of water points)

A complete risk analysis would require consideration of the different factors related to vulnerability to water-borne disease: primarily population size, followed by health issues, nutrition status, food availability, environmental factors, the water and sanitation situation etc. To standardise this complete analysis in one tool is difficult because factors can have different impacts depending on contexts and reference indicators can also be different depending on the situation. However, it is easier to do a more specific risk analysis by crossing only some parameters, as is the case in the example below where the analysis focuses on the risk of contamination of the water point and the bacteriological water quality.

This risk analysis combines measurement of actual contamination at one moment in time (done by the bacteriological analysis) and future points of risk (through the sanitary survey score). The result is a table where water points are placed in order to determine the priorities for action as shows the table below.

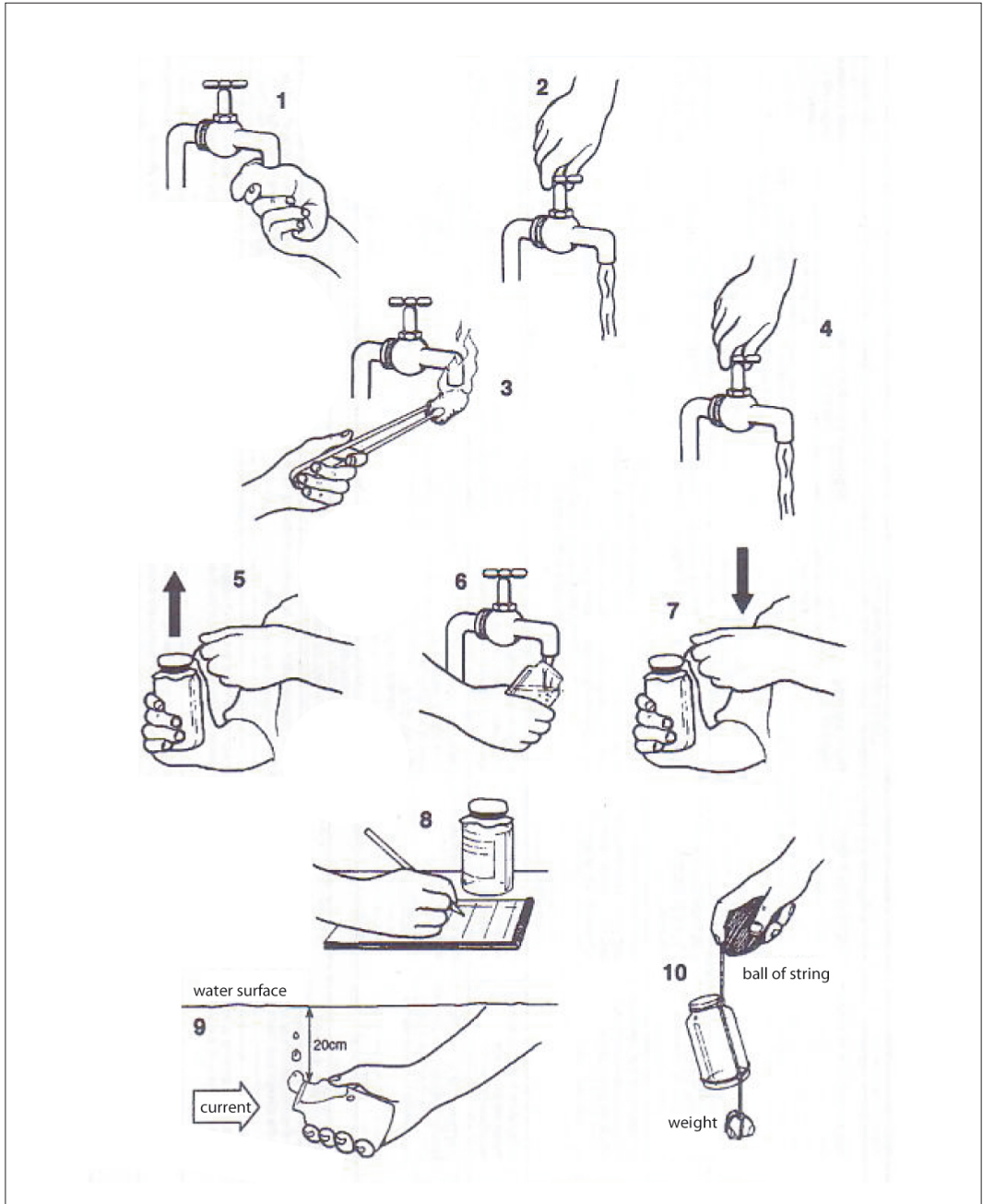
Normally, greater risks of contamination are associated with bad water quality and present an urgent priority for action, but low level faecal contamination will also require urgent action if sanitary scores are high.

Faecal coliforms/100 ml	Sanitary inspection risk score										
	0	1	2	3	4	5	6	7	8	9	10
> 100											
11 – 100											
1 – 10											
0											
Action required	A	B			C				D		

A: no action required. B: low action priority. C: higher action priority. D: urgent action priority.

# C SAMPLING PROCEDURES

PROPER SAMPLING METHOD FROM TAP AND STREAM  
*(Public health engineering in emergency situation, 1994, MSF)*





# D DELAGUA KIT

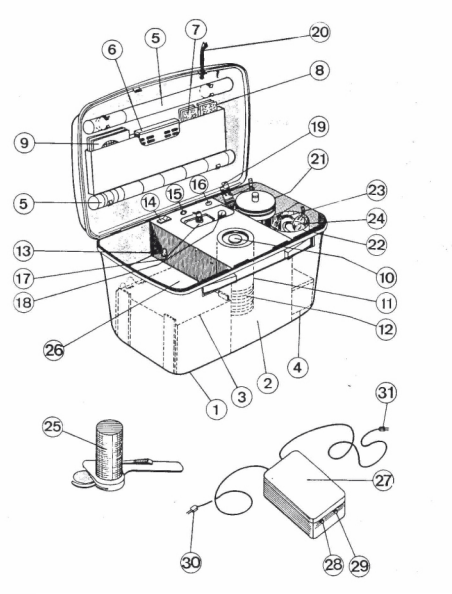
## PORTABLE KIT FOR BACTERIOLOGICAL ANALYSIS (DELAGUA KIT)

### Composition of the kit

- 4 boxes containing 50 ampoules of culture medium for faecal coliforms
- 200 filters (45 µm)
- 200 absorbent pads
- 500 sampling sachets (180 ml)
- 1 DELAGUA kit

### Culture media used by ACF

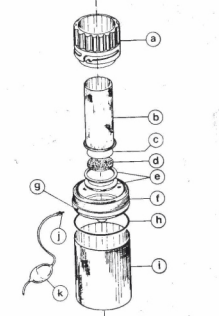
- Ready-to-use Millipore-brand culture medium, available in 2-ml plastic ampoules, for faecal coliforms. Incubation time: 18 to 24 h at 44° C.
- Faecal coliforms develop blue colonies. Other bacteria form colonies in other colours (yellow, pink, grey).



**Water Testing Kit**

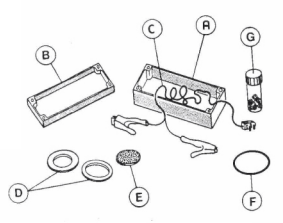
1. Case	14. On/Off Switch
2. Incubator	15. Power 'On' Indicator
3. Battery	16. Heater 'On' Indicator
4. Spares Case	17. Methanol Dispenser
5. Turbidity Tubes	18. Culture Medium Bottle
6. Chlorine an pH Comparator	19. Lighter
7. Chlorine Test Tablets	20. Tweezers
8. pH Test Tablets	21. Filtration Assembly with Sample Cup
9. Membrane Filters	22. Vacuum Cup
10. Incubator Lid	23. Sample Cabinet
11. Incubator Pot	24. Vacuum Pump
12. Petri Dishes	25. Absorbent Pad Dispenser
13. Power Socket	26. Storage Space

**Filtration Apparatus and Components**



- a. Plastic Collar
- b. Funnel
- c. Membrane Filter
- d. Bronze Disc
- e. Silicone rings (pair)
- f. Aluminium base
- g. Vacuum Connection
- h. Black Rubber O-Ring
- i. Vacuum Cup
- j. Vacuum Pump Connector
- k. Vacuum Pump

**Contents of the Spares case**



- A. Base
- B. Lid
- C. External Battery Connection Cable
- D. Silicone Rings (pair)
- E. Bronze Disc
- F. Black Rubber O-Ring
- G. Silicone Grease

**Charger Unit**

- 27. Battery Charger/Mains Power Unit
- 28. Power 'On' Indicator
- 29. Charged Battery Indicator
- 30. Incubator plug
- 31. Mains Supply Plug

# E WATER-ANALYSIS FILE

## SINGLE WATER QUALITY ANALYSIS REPORT SHEET

Site identification:

Sampling officer:

General location:

Sampling date:

Water source type:

Analysis date:

Characteristics	Parameter	Formula	Recommendation WHO 2003	Health-based guideline WHO 2003
Organoleptic	Colour	—	15	No
	Smell	—	Acceptable	No
	Taste	—	Acceptable	No
	Turbidity	—	≤ 5	No
Physicochemical	Temperature	—	Acceptable	No
	pH	—	—	No
	Conductivity	—	Acceptable	No
	Sulphates	SO <sub>4</sub> <sup>-</sup>	< 250	No
	Sodium	Na <sup>+</sup>	< 200	No
	Aluminium	Al	< 0.2	No
	Chloride	Cl <sup>-</sup>	< 250	No
Undesirable chemical	Nitrates	NO <sub>3</sub> <sup>-</sup>	—	50
	Nitrites	NO <sub>2</sub> <sup>-</sup>	—	3
	Ammonium	NH <sub>4</sub> <sup>+</sup>	< 1.5	No
	Manganese	Mn	—	0.4
Toxic elements	Fluorine	F	—	1.5
	Arsenic	As	—	0.01
	Lead	Pb	—	0.01
Disinfecting products	Chlorine	Cl <sub>2</sub>	—	5
Organic	<i>E. coli</i>	—	—	0

Recommendation from the Analysis officer:

Recommendation from the Project manager:

Unit	Sample 1	Sample 2	Sample 3	Mean	Standard deviation	Maximum value
TCU						
—						
—						
NTU						
mg/l						
mg/l						
mg/l						
mg/l						
mg/l						
mg/l						
mg/l						
mg/l						
mg/l						
mg/l						
mg/l						
mg/l						
mg/l						
mg/l						
Colonies/100 ml						



# Geophysics

## A EQUIPMENT

<b>1</b>	<b>Resistivity-measurement instructions</b>	691
<b>2</b>	<b>Internal battery charging instructions</b>	692
<b>3</b>	<b>Technical characteristics</b>	693

The  $\Omega$ mega resistivity meter was developed by ACF in collaboration with the association Aquifer. It meets most of requirements for electric geophysical exploration (DC), with a number of features that are useful in the conditions typical of humanitarian missions: ability to use different power sources (internal battery, external 12 V battery, 220 V generator set, batteries in series up to 400V), ability to recharge internal battery from external 12-V battery or a 220 V AC source. The purchase price of the ACF kit is about 4 500 €, including the complete resistivity meter, two 400-m spools (AB), two 200-m spools (MN), a compass, two 50-m tape measures, transparent log-log paper, and Caniard nomograms.

The compromise between weight, price and performance allows exploration to depths of 60 or 70 m in resistant areas (bedrock with weathering products and cover, for example), and down to 40 or 50 m in more conductive formations (clayey sedimentary formations, for example). When conditions need high power (very conductive environments, large depths), it is necessary to use equipment that is more powerful (800V, 400 W), and much more expensive.

### 1 Resistivity-measurement instructions

1) Choose MEASURE on the FUNCTION selector: the measurement devices light up.

2) Choose the power source with the POWER selector:

- internal battery
- 12 V external battery
- 230 V AC
- DC source: 400 V maximum.

3) Connect spools A-B and M-N:



4) Choose the injection voltage with the button VOLT AB:

- 25 V
- 50 V
- 100 V
- 200 V
- 400 V

5) Press MEASURE to inject the current. Wait for 3-4 seconds until the values indicated by the measurement devices stabilize, and lock the displayed values using the HOLD button.

#### Notes

- Values of I and V read on the measurement devices are never completely stable: after a few seconds of injection, values decrease together. The HOLD button freezes the measurements to facilitate simultaneous reading of the measured values.
- Start the injection below 25 V (selector VOLT AB). For maximum accuracy in measurements, increase the voltage when indicated values of V are lower than 10 mV.
- When the injection button (MEASURE) is released, a short beep can be heard. This means that everything is normal. If this beep occurs during injection, i.e. when the MEASURE button is pressed, this indicates:
  - the battery is flat and needs to be recharged;
  - or that the injection voltage is too high (power of the device is insufficient): take another measurement using a lower voltage, e.g. 200 V instead of 400 V.

## 2 Internal battery charging instructions

1) Set the FUNCTION button to INT. BATT. CHARGE.

2) Set the POWER button to the available power source:

- MAIN 230V or
- 12 V EXT.BAT.

3) Connect the chosen source to the case with clamps or power connectors: the green pilot lamp lights up. Then there are two possible charge programmes:

A. If you have less than 18 hours to recharge the internal battery: leave the case as it is after operations 1, 2, and 3 (do not press START). In this case, the battery is charged to 1/28 of its capacity per hour, that is to say, about 30% of its capacity in one night.

B. If you have 18 hours or more, press START. The green pilot lamp goes out, and the following cycle begins:

- discharging the battery: the red pilot lamp lights up, and goes out when discharge is complete (depending on the remaining capacity of the battery, the duration of this discharge operation varies between several minutes and four hours);
- recharge for 14 hours: as soon as the red pilot lamp goes out, the charging cycle begins. When charging is complete, the green pilot lamp lights up again. The battery is then completely charged.

#### Notes

- A charge-cycle B which has already started must never be interrupted before the green pilot lamp lights up again: as the cycle starts with a discharge, there is a risk of discharging the battery without having time to recharge it again.
- In the event of a power failure during the A or B charging process, the cycle restarts automatically at the point where it stopped, as long as no control buttons have been touched.
- In order to stop a cycle (if you have pressed START accidentally), set the FUNCTION button on OFF for one minute, and then restart charge A.
- If the battery has been completely discharged, the charge-cycle B cannot start at all (the green pilot lamp does not go out). It is then necessary to charge the battery for one hour on cycle A, and then to revert to cycle B while pressing START.

### 3 Technical characteristics

#### Internal battery

- Ni mH (metallic Nickel Hydroxide) 12 V and 7 Ah (i.e., 0.7 A for 10 hours, and up to a maximum of 30 A for short bursts).
- Number of possible measurements with the internal battery completely charged: from 150 to 1 000.

#### Converter (DC/AC)

- Power = 150 W.

#### Transformer

- Power = 75 W (220V and 0.35 A, efficiency 90%).
- 25 V / 3 A.
- 50 V / 1.5 A.
- 100 V / 0.75 A.
- 200 V / 370 mA.
- 400 V / 185 mA.

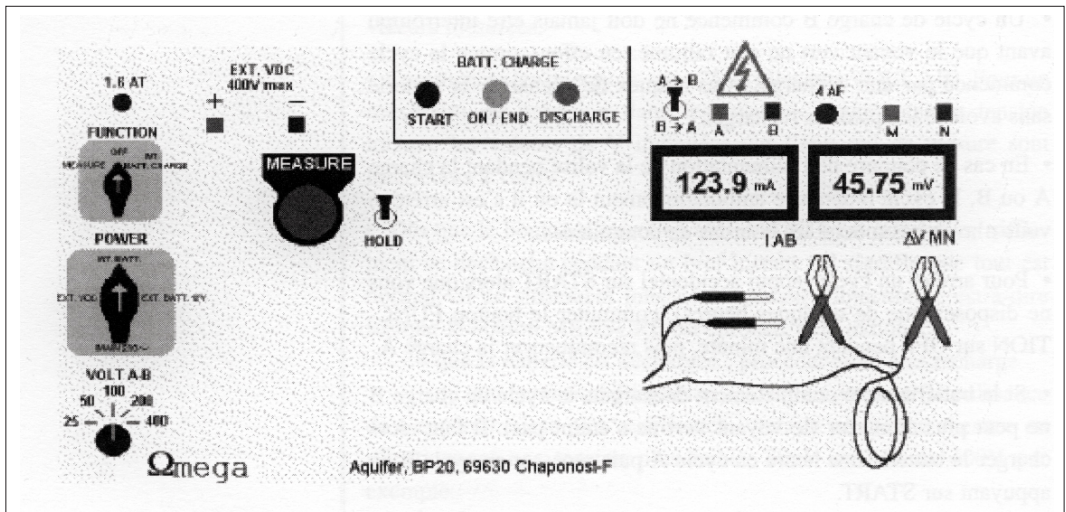
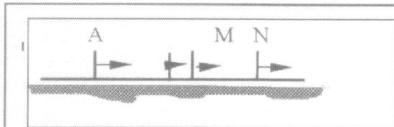


Figure 1: Front of the Omega resistivity meter.

# B ELECTRICAL SUMMARY FILES

## RESISTIVITY PROFILING FILE

<b>Resistivity profiling</b>	<b>Date:</b>	<b>Location :</b>		
<b>Array:</b> Schlumberger	<b>Reference :</b>	<b>X:</b>	<b>Y:</b>	<b>Z:</b>



Observation - Sketch

$$\text{Resistivity } \rho_a = K \times \Delta V / I$$

$$K = \pi \times (AM \times AN) / (MN)$$

$$AB = 200$$

$$MN = 20$$

$$K = 1555$$

Profile n° : \_\_\_\_\_ Direction of profile : N \_\_\_\_\_

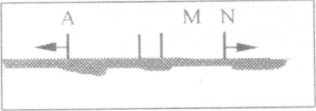
point	$\Delta V$ (mV)	I (mA)	$\rho_a$ (ohm/m)
0			
10			
20			
30			
40			
50			
60			
70			
80			
90			
100			
110			
120			
130			
140			
150			
160			
170			
180			
190			
200			

point	$\Delta V$ (mV)	I (mA)	$\rho_a$ (ohm/m)
210			
220			
230			
240			
250			
270			
280			
290			
300			
310			
320			
330			
340			
350			
360			
370			
380			
390			
400			
410			
420			



# RESISTIVITY SOUNDING FILE

<b>Resistivity sounding</b>	<b>Date:</b>	<b>Location :</b>		
<b>Array:</b> Schlumberger	<b>Reference:</b>	<b>X:</b>	<b>Y:</b>	<b>Z:</b>



Resistivity  $\rho_a = K \times \Delta V / I$   
 $K = \pi \times (AM \times AN) / (MN)$   
 AB max =  
 MN overlaps =

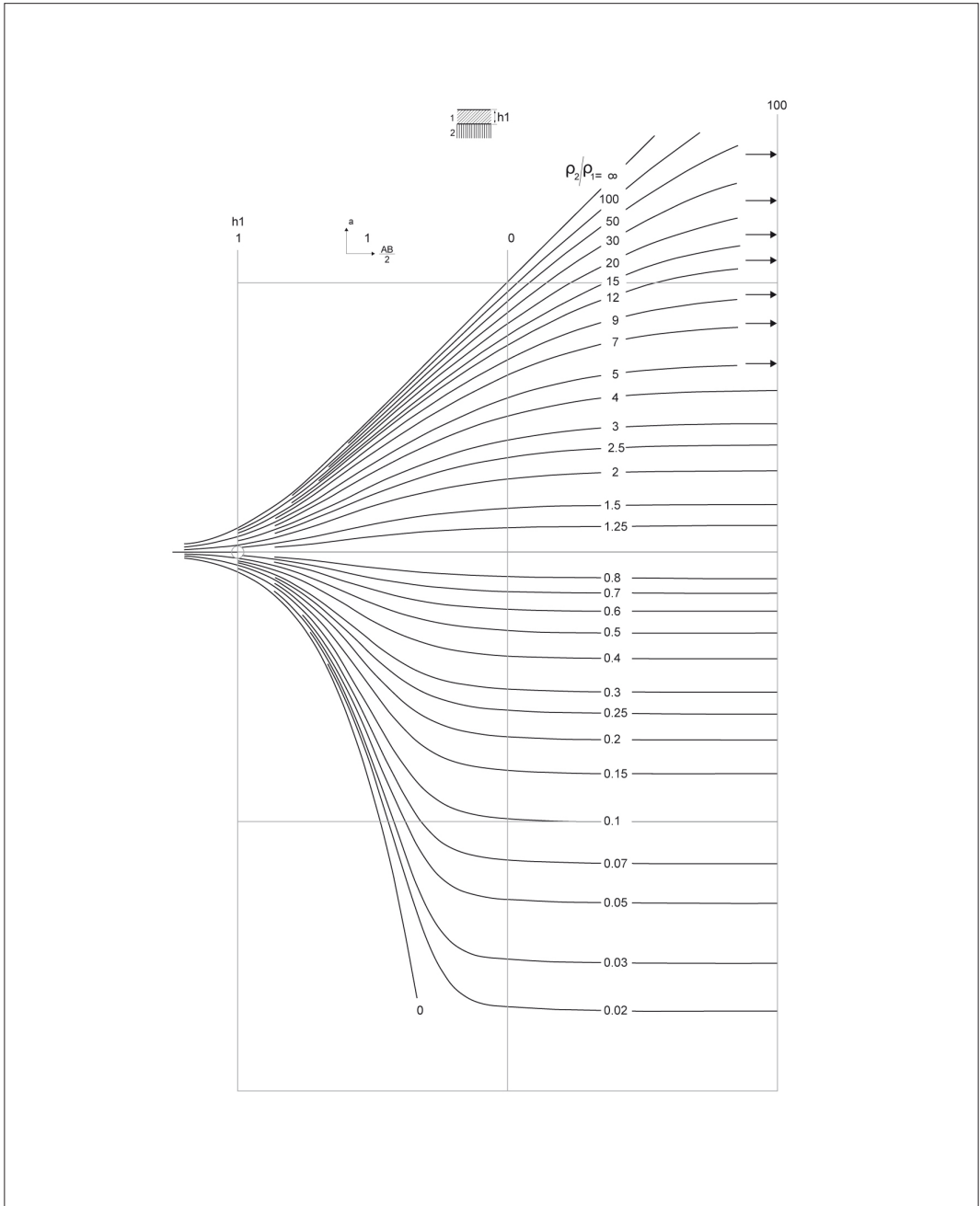
**Observation - Sketch**

Sounding n° : \_\_\_\_\_ Profile point: \_\_\_\_\_ Direction of sounding : N \_\_\_\_\_

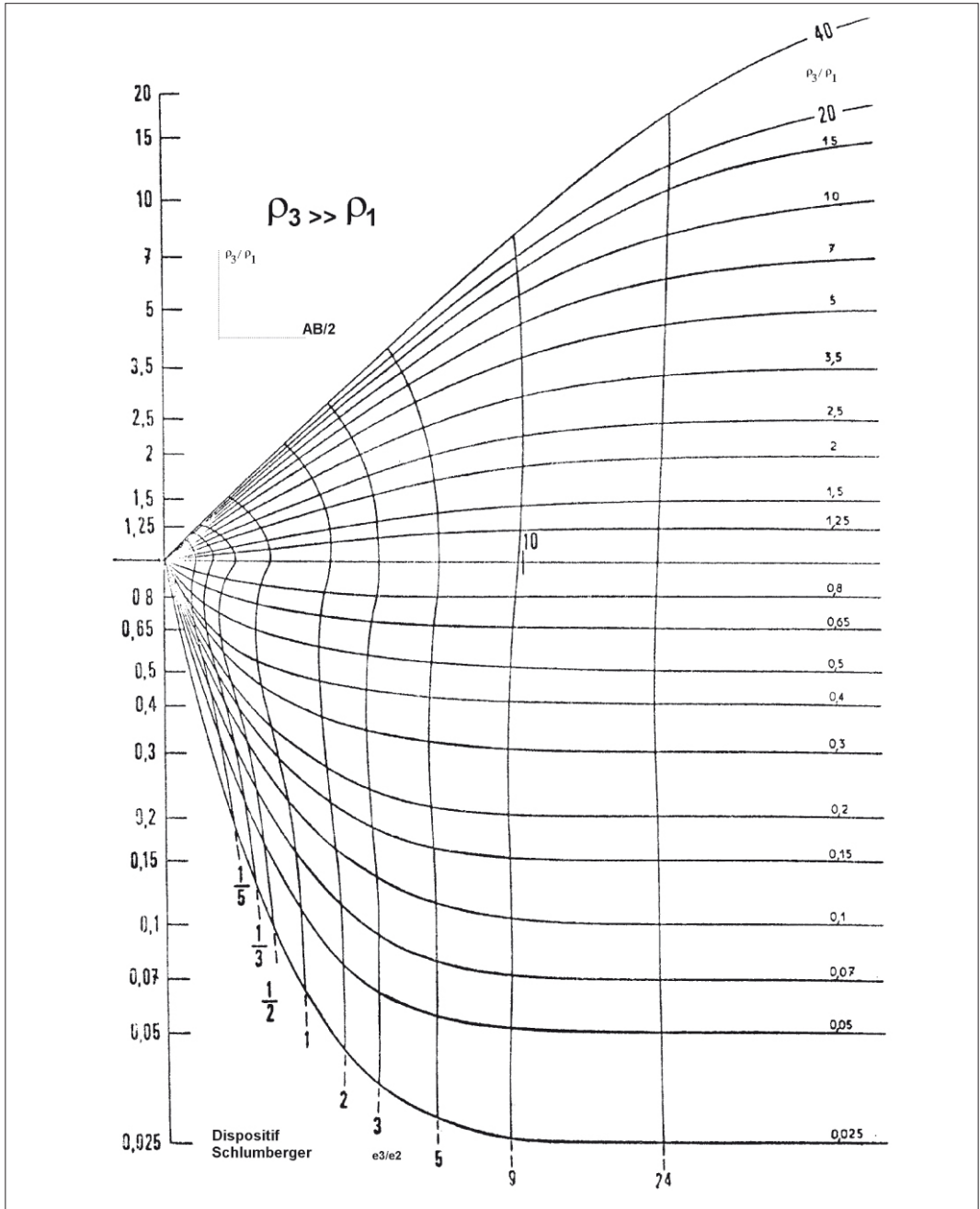
AB/2	MN=2	MN=10	MN=40	$\Delta V$ (mV)	I (mA)	$\rho_a$ hm - m
2	4,71					
3	12,5					
4	23,5					
5	37,7					
6	55					
8	99					
10	155					
15	352	62,8				
20	627	118				
25	980	188				
30	1412	275				
35	1922	377				
40	2511	495				
50	3925	780				
60	5653	1120				
70		1530				
80		2000	471			
100		3130	754			
120		4900	1100			
150		7050	1736			
175			2374			
200			3110			

# C NOMOGRAMS

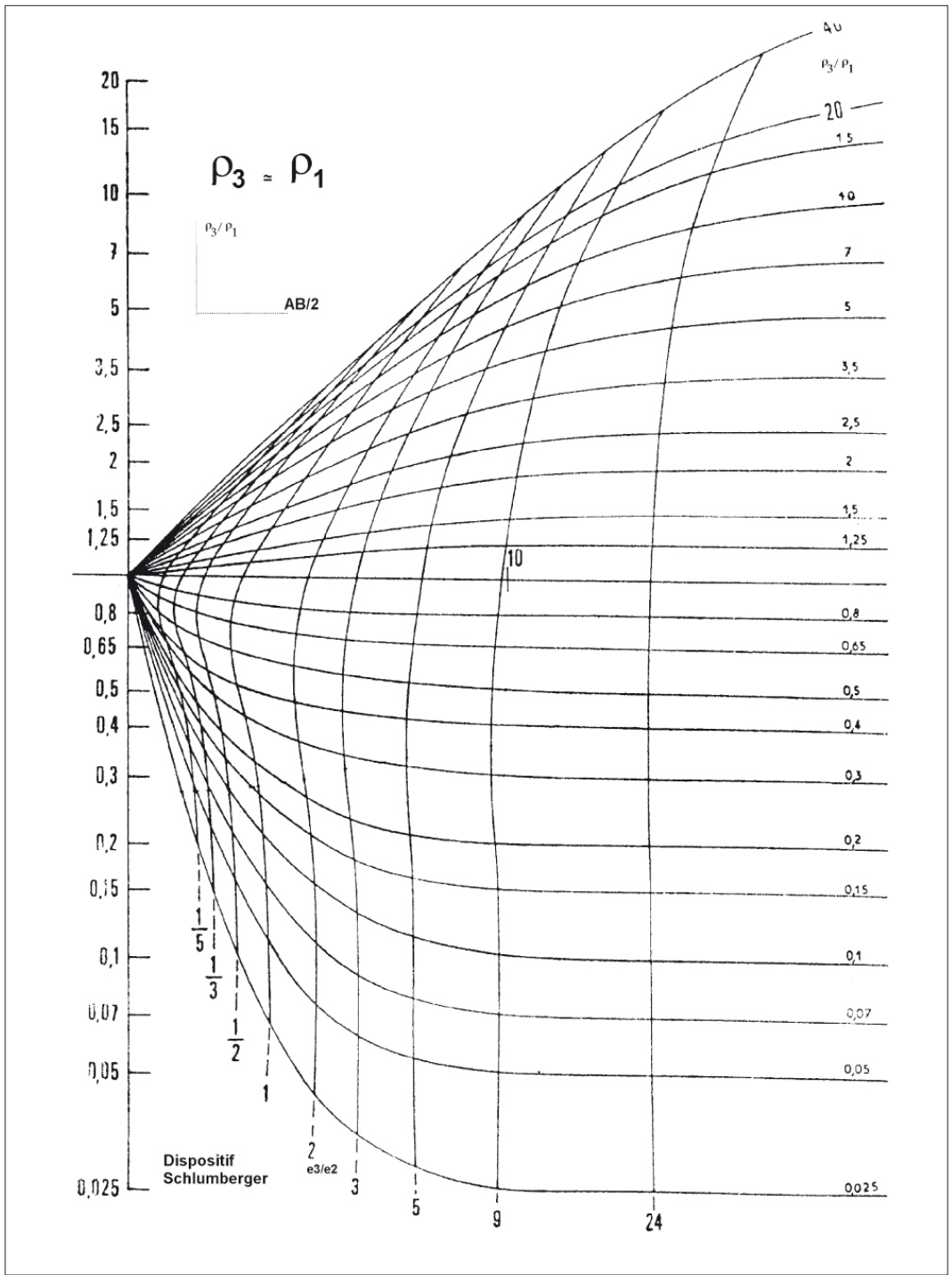
## NOMOGRAMS FOR INTERPRETATION OF SCHLUMBERGER ELECTRICAL SOUNDING TWO-FORMATION NOMOGRAM



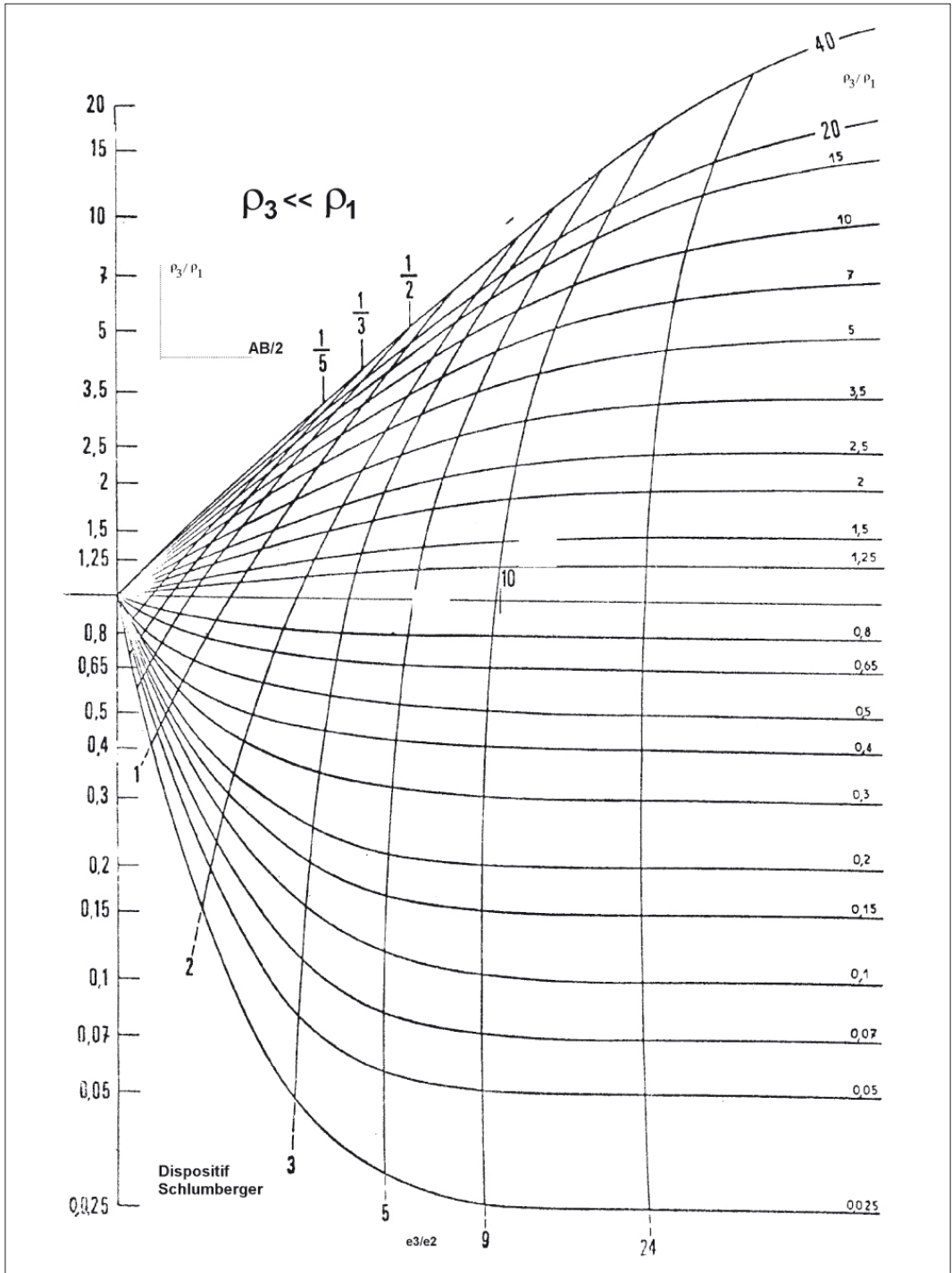
AUXILIARY NOMOGRAM ( $\rho_3 \gg \rho_1$ )



AUXILIARY NOMOGRAM ( $\rho_3 = \rho_1$ )



AUXILIARY NOMOGRAM ( $\rho_3 \ll \rho_1$ )





# Pumping-test files

## PUMPING TEST WITH 3 NON-CONNECTED STEPS

Location:	Borehole / well reference:		
Date:	Test conducted by:		
<b>Characteristics of the well / borehole</b>			
Depth:	Diameter:	SWL:	/ground
Thickness of the aquifer:		SWL:	/datum
Height of the water column:		Ground/datum high:	
Yield after development:		Screen top level:	/ground

Step n°1							Recovery			
Time (h:mn)	Time elapsed (mn)	Water level (m)	Yield (m <sup>3</sup> /h)	Conductivity (µS/cm)	T°	Remarks	Time (h:mn)	Time elapsed (mn)	Water level (m)	Draw down (m)
	0							0		
	3							3		
	5							5		
	10							10		
	15							15		
	20							20		
	30							30		
	40							40		
	50							50		
	60							60		
	80							80		
	100							100		
	120							120		

Step n°2							Recovery			
Time (h:mn)	Time elapsed (mn)	Water level (m)	Yield (m <sup>3</sup> /h)	Conductivity (µS/cm)	T°	Remarks	Time (h:mn)	Time elapsed (mn)	Water level (m)	Draw down (m)
	0							0		
	3							3		
	5							5		
	10							10		
	15							15		
	20							20		
	30							30		
	40							40		
	50							50		
	60							60		
	80							80		
	100							100		
	120							120		

Step n°3							Recovery			
Time (h:mn)	Time elapsed (mn)	Water level (m)	Yield (m <sup>3</sup> /h)	Conductivity (µS/cm)	T°	Remarks	Time (h:mn)	Time elapsed (mn)	Water level (m)	Draw down (m)
	0							0		
	3							3		
	5							5		
	10							10		
	15							15		
	20							20		
	30							30		
	40							40		
	50							50		
	60							60		
	80							80		
	100							100		
	120							120		



**PUMPING TEST WITH 1 STEP**

Location:	Well / borehole reference:
Date:	Test conducted by:

<b>Characteristics of the well / borehole</b>	
Depth:	SWL:            /ground
Diameter:	SWL: /datum
Thickness of the aquifer:	Ground/datum high:
Hight of the water column:	Screen top level:            /ground
Yield after development:	

Drawdown							Recovery			
Time (h:mn)	Time elapsed (mn)	Water level (m)	Yield (m <sup>3</sup> /h)	Conductivity (μS/cm)	T°	Remarks	Time (h:mn)	Time elapsed (mn)	Water level (m)	Draw down (m)
	0							0		
	3							3		
	5							5		
	10							10		
	15							15		
	20							20		
	30							30		
	40							40		
	50							50		
	60							60		
	80							80		
	100							100		
	120							120		
	140									
	160									
	180									
	200									
	220									
	240									

Remarks:



III

Water supply

# Protection of water resources

<b>1</b>	<b>Groundwater</b>	705	<b>2</b>	<b>Surface water</b>	706
1.1	Migration of bacterial pollution	705	2.1	Exploitation of a stream	706
1.2	Protection zone	705	2.2	Protecting ponds	707
1.2.1	Wells and boreholes	705	<b>3</b>	<b>Abstraction, transport and storage of water</b>	707
1.2.2	Springs	705			

In humanitarian programmes, in terms of public health, the most frequent risk of pollution of water for human consumption is faecal contamination. Protection of water sources consists of excluding polluting activities from a certain area around the water point, and implementing measures that allow water quality to be maintained after abstraction, up to the time of consumption. Water resources may be differentiated according to their vulnerability to pollution (see Chapter 3).

## 1 Groundwater

### 1.1 Migration of bacterial pollution

See Chapter 13, Section 3.5.

### 1.2 Protection zone

#### 1.2.1 WELLS AND BOREHOLES

In a continuous environment, the protection zone is the area up to 30 m around the water point (Figure 1). Sources of pollution (latrines, waste pits, septic tanks etc.) must be located outside this zone, preferably downstream of it. It is important to maintain a minimum depth of 2 m between the bottom of latrine pits etc. and the water table.

#### 1.2.2 SPRINGS

The protection zone upstream of springs is also 30 m (Figure 2). It must be protected by an enclosure, preferably with a hedge.

A 0.50 m deep ditch must be dug to divert run-off water.

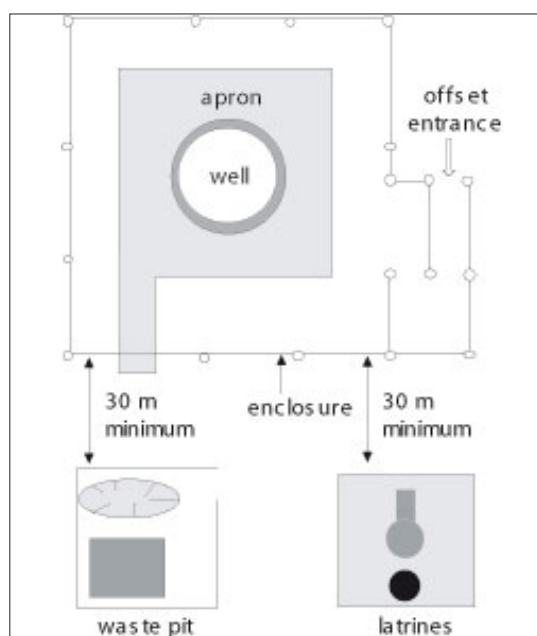
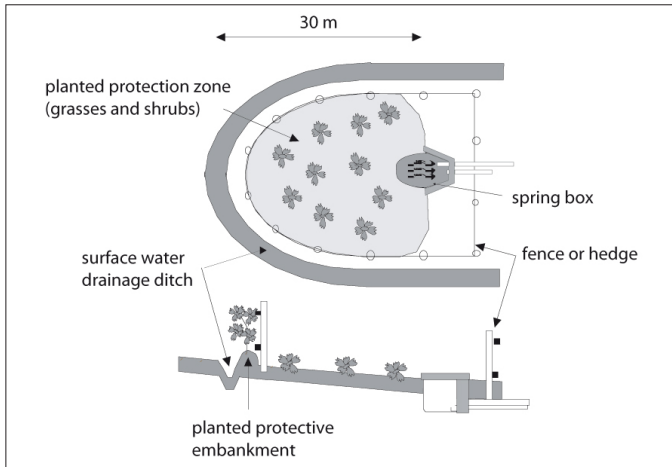


Figure 1: Protection zone of a well/borehole in a continuous environment.



**Figure 2: Protection zone of a spring.**

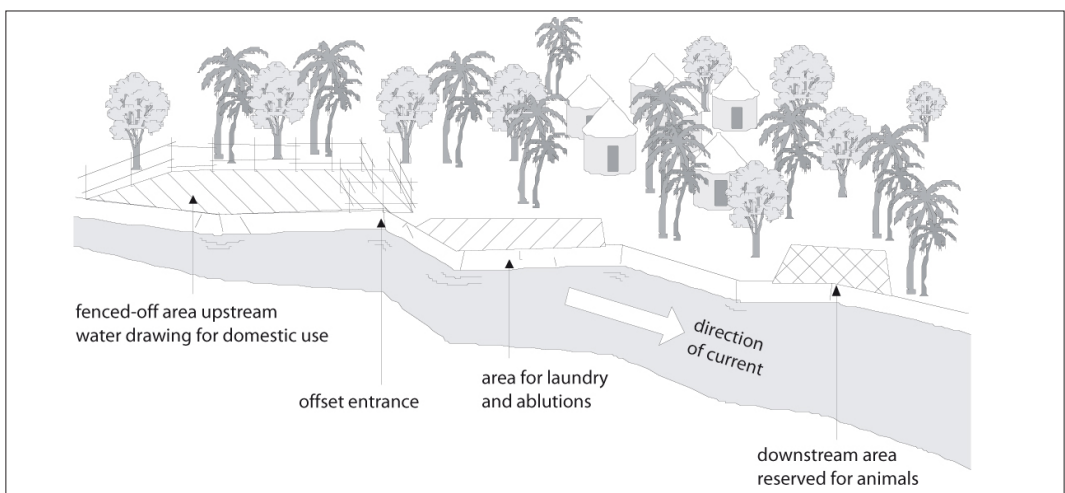
To limit the erosion of the protection zone, which sometimes has a considerable slope, bushes and grass are planted (note: not trees), which also allows this zone to be distinguished from the surrounding terrain.

## 2 Surface water

It is very difficult to protect surface water from pollution. However, surface water is easy to access, and is therefore often used as a water source in emergency situations.

### 2.1 Exploitation of a stream

It is rare to be able to decide where a population should be located, and most interventions take place on sites that are already settled. Along a stream, good site planning takes into account flow direction and water usage, making sure that pollution of the watercourse is restricted (drainage), and placing the latrines more than 30 m away from the stream, downstream of the site (Figure 3).



**Figure 3: Example of a layout along the bank of a river.**

Water for domestic use is abstracted upstream, in a well-defined area reserved for this purpose; a fence or hedge with an offset entrance keeps animals out. Just downstream, an area is created for clothes washing (and possibly ablutions). Much further downstream, another area is reserved for watering animals.

## 2.2 Protecting ponds

In certain areas such as Africa and Asia, ponds are the only water source used. They contain stagnant surface water, which presents many problems: they are difficult to protect, pollution is not carried away as there is no flow, and they have limited capacity to ‘digest’ organic pollution, which is frequent.

An example of protection works carried out by ACF in Myanmar is shown in Figure 4.



**Figure 4: Pond layout (Myanmar, ACF, 1997).**

## 3 Abstraction, transport and storage of water

Water pollution often occurs at water points during abstraction. It is therefore important to protect wells, springs and boreholes correctly. Monitoring of the bacteriological quality of borehole water carried out in a bedrock area by ACF (Sudan, 1996-1997) showed a relationship between water pollution and the quality of borehole grouting and surface works; surface works are mentioned in Annex 14 and in the sections dealing with specific types of water point.

Protective measures must not stop at the water point: they must be applied until the moment the water is consumed. It is therefore necessary to prevent water from becoming polluted during transport and storage.

Vessels must be closed, and cleaned regularly (if possible with 100mg/l chlorine solution – see Chapter 12). It is preferable to use jerrycans than buckets. If buckets are used, water has to be taken with a cup or other container, which may be exposed to flies, dirty hands etc., whereas if a jerrycan is used, the water can be poured out or taken via a tap.



# Drilling

## A DRILLING EQUIPMENT

1	ACF-PAT 201 rotary drilling rig	709	5	Down-the-hole hammer	714
2	ACF-PAT 301 rotary-DTH mixed drilling rig	710	6	Three-bladed bits, for-bladed bits and tricone bits (2004)	715
3	ACF-PAT 401 PTO mixed rotary-DTH drilling rig	711	7	Threaded PVC borehole casing and screen (2004)	716
4	ACF-PAT 301 T	712			

This annex lists the materials and equipment needed for drilling programmes. The drilling rigs have been developed in collaboration with the firm PAT (Promotion of Appropriate Technology), based in Bangkok, Thailand (e-mail: pat@pat-drill.com, web site: www.pat-drill.com).

### 1 ACF-PAT 201 rotary drilling rig

The PAT 201 is the first of the PAT series, and the oldest. Its design (very light and easy to use), and its cost make it a machine particularly well suited to drilling in non-consolidated sedimentary terrains. The whole kit weighs less than a tonne, and can be transported in a pick-up truck.

ACF has developed 'itinerant' drilling programmes in Myanmar, transporting this rig from village to village by boat, and has also created numerous water points in Cambodia. This rig is particularly well-suited to isolated areas, such as the Bar El Gazal, in Southern Sudan, where boreholes equipped with hand-pumps have been drilled, or for water exploration before digging wells.



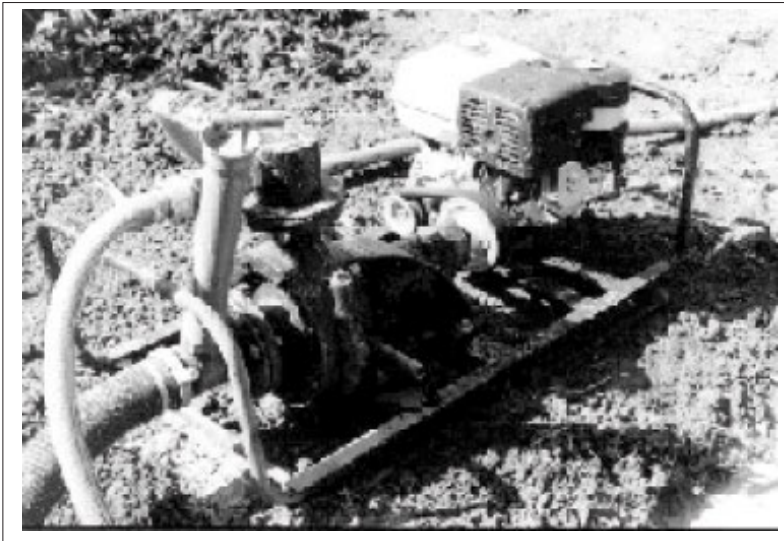
Figure 1: ACF-PAT 201 frame.



**Figure 2: ACF-PAT 201.  
Three-bladed drilling bits.**



**Figure 3: ACF-PAT 201.  
Development compressor.**



**Figure 4: Mud pump.**

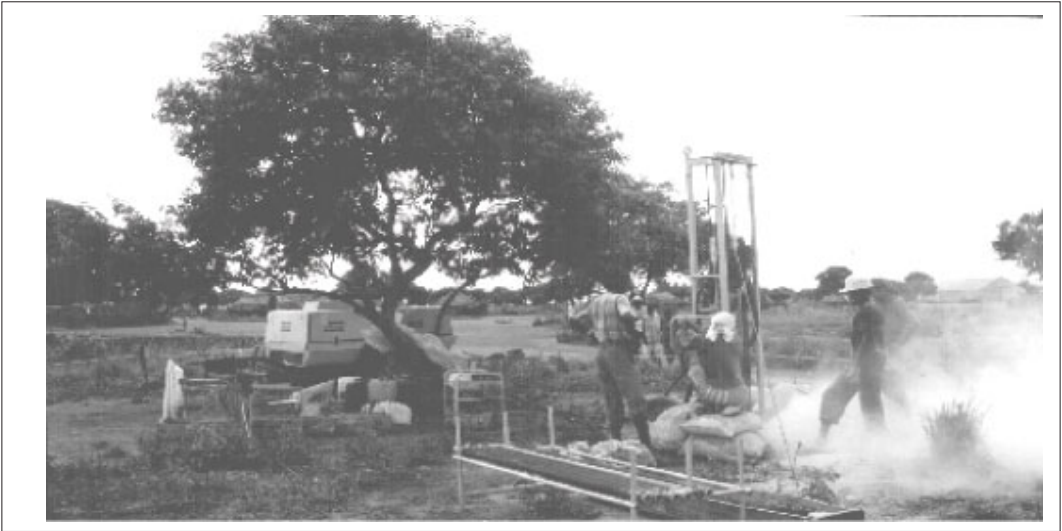
Because of its design, the kit enables a quick start to a drilling programme. In addition to the drilling machine elements (frame, mud pump, development compressor, drill pipes, drill bits etc.), there are tools, spares and drilling consumables.

The machine, in this version, is limited to a depth of 60 m with a 6<sup>1/2</sup> diameter. An improved version has been designed for drilling beyond this depth.

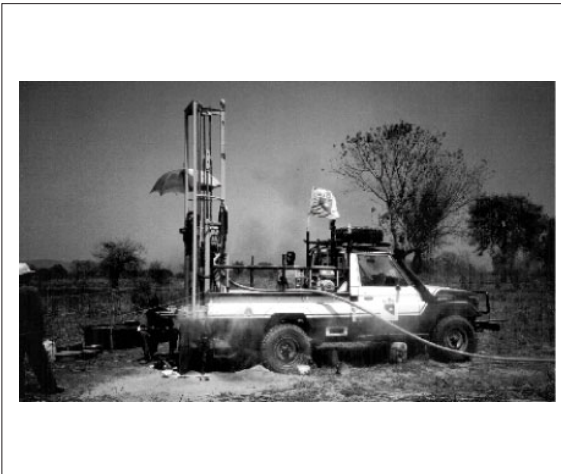
## 2 ACF-PAT 301 rotary-DTH mixed drilling rig

The ACF-PAT 301 is a portable DTH-hammer hydraulic rotary drilling rig, designed to work in a variety of geological contexts: non-consolidated formations (alluvia, weathered formations etc.) and consolidated formations (bedrock, old sedimentary formations etc.).

The rig is made up of separate elements: drilling mast, hydraulic unit, mud pump, and compressor. This facilitates transport in isolated or areas, or areas difficult to access. All the drilling accessories are supplied with the kit (rods, hammer, bits), and also some consumables (hydraulic oil, poly-col, foam etc.). This rig can be mounted on a Toyota Land Cruiser pick-up or a truck, or can be set up directly on the ground.



**Figure 5: ACF-PAT 301. Rig on the ground.**



**Figure 6: Rig on a vehicle.**



**Figure 7: Rig, hydraulic pump, compressor.**

### 3 ACF-PAT 401 PTO mixed rotary-DTH drilling rig

The ACF-PAT 401 is a drilling rig installed on an Toyota Land Cruiser pick-up or a Dyna light truck. The rig is powered by the vehicle engine via a power take-off which drives the hydraulic pumps for the rotation of the drilling head, raising and lowering the drilling rods, the stabilising jacks, and the mud and foam pump. This rig can be delivered on the drilling platform or directly on the vehicle (Dyna).

Assembling the rig on the Land Cruiser requires several days in a workshop. Modifications required to the vehicle are very few (reinforcement of the springs, power take-off, and installation of the platform on the chassis).





**Figure 8: ACF-PAT 401. Rig on a Dyna truck.**

**Figure 9: Rig on a Land Cruiser.**



This rig is more powerful than the PAT 301, it is more easily manoeuvrable, and the set-up time is less. The vehicle can be set level immediately with the jacks. The rig can be used in rotary mode, and in DTH 5" mode (165 mm bit). The drilling depth is more than 100 m in sedimentary formations. ACF has used this rig in Angola (Dyna version), and Honduras (Land Cruiser version).

#### **4 ACF-PAT 301 T**

The PAT-Drill 301T combines an onboard power pack, drill pipe storage and foam pump on a single-axle trailer. This makes for a quick set up in most locations and is an ideal multipurpose rig for many water well drilling operations.



**Figure 10: ACF-PAT 301 T.  
Rig in drilling position.**

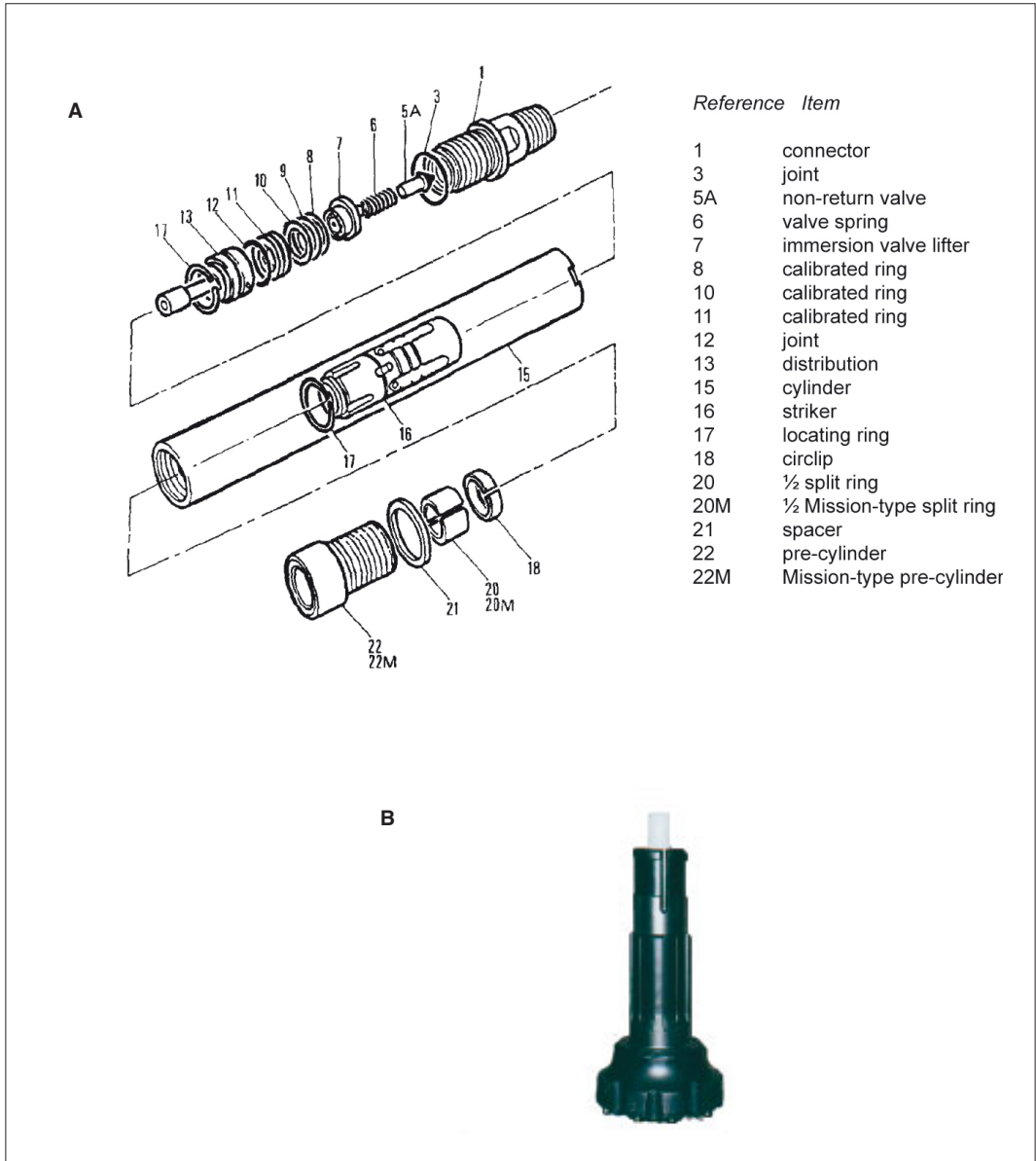


**Figure 11: Rig  
in transporting position.**

## 5 Down-the-hole hammer

Technical characteristics:

- length 1 012 mm.
- external diameter 114 mm.
- weight 54 kg.
- diameter of drilling done by ACF 150 and 165 mm bits.



**Figure 12: Down-the-hole hammer.**

**A: DTH-hammer parts list. B: drilling bit.**

## 6 Three-bladed bits, four-bladed bits and tricone bits (2004)

Diameter		Thread	Unit cost (€)	Diameter		Thread	Unit cost (€)
(inches)	(mm)			(inches)	(mm)		
<b>THREE-BLADED BITS</b>				<b>FOUR-BLADED BITS</b>			
3" 1/2 to 3" 7/8	—	2" 3/8R	141.50	3"	76.20	NROD	184.80
4" to 4" 3/8	—	2" 3/8R	148.70	3" 1/8	79.38	NROD	190.00
4" 1/2 to 4" 7/8	—	2" 3/8R	158.62	3" 1/4	82.55	NROD	189.00
5" to 5" 3/8	—	2" 3/8R	167.20	3" 1/2	88.90	NROD	194.40
5" 1/2 to 5" 7/8	—	2" 3/8R	172.91	3" 3/4	95.25	NROD	197.00
6" to 6" 3/8	—	2" 3/8R	180.10	3" 7/8	98.43	NROD	202.00
6" 1/2 to 6" 7/8	—	3" 1/2R	230.10	4" 1/4	107.95	NROD	265.00
		2" 3/8R	185.77	4" 3/4	120.65	NROD	295.00
		3" 1/2R	247.22				
7" to 7" 3/8	—	3" 1/2R	278.70				
7" 1/2 to 7" 7/8	—	3" 1/2R	294.40				
8" to 8" 3/8	—	3" 1/2R	310.10				
8" 1/2 to 8" 7/8	—	3" 1/2R	325.90				
9" to 9" 3/8	—	3" 1/2R	341.60				
9" 1/2 to 9" 7/8	—	3" 1/2R	357.25				
10" to 10" 3/8	—	3" 1/2R	371.60				
10" 1/2 to 10" 7/8	—	3" 1/2R	407.30				
11" to 11" 3/8	—	3" 1/2R	437.30				
12" to 12" 3/8	—	3" 1/2R	468.80				
12" 1/2 to 12" 7/8	—	3" 1/2R	484.50				
13" to 13" 3/8	—	3" 1/2R	515.90				
13" 1/2 to 13" 7/8	—	3" 1/2R	547.40				
14" to 14" 3/8	—	3" 1/2R	600.20				
14" 1/2 to 14" 7/8	—	3" 1/2R	628.76				
<b>TRICONE BITS</b>							
<i>Tricone bits with many small teeth, used for hard formations</i>				<i>Tricone bits with larger teeth, used for softer formations</i>			
3" 7/8	98.43	2" 3/8	270.00	3"	76.20	2" 3/8	170.00
4" 3/4	123.83	2" 7/8	356.00	3" 1/2	88.90	2" 3/8	170.00
5" 3/4	146.05	3" 1/2	418.00	3" 7/8	98.43	2" 3/8	170.00
5" 7/8	149.23	3" 1/2	482.00	4"	101.60	2" 3/8	192.92
6"	152.40	3" 1/2	580.00	4" 1/4	107.95	2" 3/8	192.92
		4" 1/2	114.30	2" 3/8	192.92		
		4" 3/4	120.65	2" 7/8	204.00		
		4" 7/8	123.83	2" 7/8	238.00		
		5" 1/2	139.70	3" 1/2	297.00		
		5" 7/8	149.23	3" 1/2	311.00		
		6"	152.40	3" 1/2	339.00		
		6" 1/8	155.58	3" 1/2	370.00		
		6" 1/4	158.75	3" 1/2	370.00		
		6" 1/2	165.10	3" 1/2	370.00		
		6" 3/4	171.45	3" 1/2	400.00		

## 7 Threaded PVC borehole casing and screen (2004)

– Net price ex-works.

– Basic length in stock; supplements for other lengths as follows: 2.90 m, 10%; 1.95 m, 15%; 0.95 m, 20%.

– 1-mm slotted screens; supplements for other slot sizes: 0.75/1.5/2/3 mm, 10%; 0.5 mm, 15%; 0.2/0.36 mm, 20%.

Size	Diameter (mm)	Thickness (mm)	Weight (kg/m)	Resistance (bar)	Length (m)	Type of joint	Price (€/m)	
							casing	screen
ND40, 1" 1/2	35 x 42	3.5	0.75	47	3.00	W	2.35	3.80
ND 50, 2"	52 x 60	4.00	1.05	23	3.00	W	3.13	4.72
ND 65, 2" 1/2	64 x 75	5.50	1.90	30	2.90	N	5.52	7.50
ND 80, 3"	80 x 90	5.00	2.05	13	2.90	M	5.91	8.25
ND 100, 4"	104 x 114	5.00	2.50	6	2.90	M	7.07	9.94
ND 112, 4" 1/2	112 x 125	6.50	3.50	8	2.90	M	9.28	12.28
ND 125, 5"	126 x 140	7.00	4.30	9	4	M	13.30	15.84
ND 150, 6"	150 x 165	7.50	5.40	7	4	M	15.37	19.07
ND 165, 6" 1/2	163 x 180	8.50	6.5	8	4	M	18.74	23.26
ND 175, 7"	178 x 195	8.50	7.30	6	3	M	23.17	28.92
ND 175, 7"	180 x 200	10.00	8.50	9	3	M	23.17	28.92
ND 200, 8"	205 x 225	10.5	10.2	8	3	M	31.00	38.67
ND 225, 9"	225 x 250	12.5	13.4	9	3	M	45.00	52.00
ND 250, 10"	255 x 280	12.50	15.90	7	3	M	53.00	69.70
ND 300, 12"	286 x 315	14.50	20.30	8	3	M	60.00	84.00
ND 350, 14"	389 x 400	10.50	18.50	1	3	M	63.80	87.00

# B DRILLING LOG

DRILLING LOG N° .....

Location: \_\_\_\_\_ Operation: from \_\_\_\_\_ to \_\_\_\_\_  
 Co-ordinates: \_\_\_\_\_ Drilling rig: Total time: \_\_\_\_\_  
 Drilling officer: \_\_\_\_\_ Geologist: \_\_\_\_\_

Depth (m)	Time (min/rod)	Geological description (reaction to HCl)	Conductivity (μS/cm)	Water struck (estim. yield)	Observations (drilling technique, bit diameter, addition of polycol, foam etc.)	Casing plan
0						
2						
4						
6						
8						
10						
12						
14						
16						
18						
20						
22						
24						
26						
28						
30						
32						
34						
36						
38						
40						
42						
44						
46						
48						
50						

Borehole depth:	m	Static water level:	m	Estim. yield:	m <sup>3</sup> /h
Hydrogeological context:				Conductivity:	μS/cm
Dynamic water level:	m				
	Height	Casing dia.	Borehole dia.	Gravel pack:	l
Head casing:	m			Size:	m
Casing:	m			Type:	
Screen/slot size:	m mm				
Settling casing:	m				

Comments:

# C DEVELOPMENT FILE

BOREHOLE DEVELOPMENT FILE N° .....

Location:		Compressor:	Works: from	to
Coordinates:			Total use time:	
Supervisor:				
Borehole depth:	m	Static water level:	m	Hydrogeological context:
Location of screens:				

	Depth (m)		Time (min.)	Measured yield (litre/sec)	Dynamic water level (m)	Water clearness (clay, sand etc.)	Conductivity ( $\mu$ S/cm)
	pipe	hose					
Pumping							
Flushing							
Pumping							
Pumping							
Flushing							
Pumping							
Pumping							
Flushing							
Pumping							
Pumping							
Flushing							
Pumping							
Pumping							
Flushing							
Pumping							
Pumping							
Flushing							
Pumping							
Pumping							
Flushing							
Pumping							
Pumping							
Flushing							
Pumping							
Pumping							
Flushing							
Pumping							
Pumping							
Flushing							
Pumping							

Total development time:		Water clearness:		Conductivity:	mS/cm
Estimated yield:	l/h	Dynamic water level:	m		

Comments:

# D BOREHOLE FILE



FIELD EXAMPLE

Cunene Province

## LOCATION

<b>ADMINISTRATION</b>		<b>CO-ORDINATES (UTM)</b>	
District:	Cuanhama	North:	8103291
Commune:	Sede	East:	545081
Locality:	O'Chiunga	Map:	446
No Borehole:	38A/99/BC		

## TECHNICAL CHARACTERISTICS

<b>BOREHOLE</b>			<b>PUMP</b>	
Depth (m):		31.08	Kind of pump:	Volanta
Static water level (m):		12	Cylinder depth (m):	27.8
Yield (l/h):		600	<b>WATER</b>	
Dynamic level (m):		24	Quality (E. Coli/100 ml):	0
<b>AQUIFER</b>			Conductivity (µS/cm):	1 068
Geology	Sedimentary	Porous	Piezometer	No
Location-type	From 18 to 29 m	Confined		

## AROUND WATER POINT

<b>COMMUNITY MOBILISATION</b>		<b>POPULATION</b>	
Committee:	Done day 22.12.1999	No of persons:	900
<b>INSTALLATION</b>		School:	5 km
Cattle trough:	For goats	Health post:	No
Washing area:	Yes	No of cattle:	1 222
Fence:	Done	No of goat/sheep:	3 323

## DRILLING

Topsoil	<b>Geology</b>	<b>Equipment</b>	<b>WORK</b>	
Clay with medium sand			10-06-1999 0845	Start
Clay		Screen	10-06-1999 1202	Stop
Clay with medium sand		Casing	<b>EQUIPMENT</b>	
Coarse sand			Rig:	PAT 401
Clay with fine and medium sand			Drilling technique:	Rotary
			Drilling fluid:	Polycol
			Bits ("):	8.5
			Pipes:	PVC, 4.5"
			Casing (m):	19
			Screens (m):	11
			Settling pipe (m):	1
			Centralisers:	Yes
			Vol. gravel pack (l):	320
			Diam. gravel (mm):	2

Comments:





# Hydraulics and units of measurement

## A HYDRAULICS

<b>1</b>	<b>Preliminary definitions</b>	721	<b>5</b>	<b>Head losses</b>	726
1.1	Magnitudes	721	5.1	Linear head losses	726
1.2	Regimes in forced flow	722	5.1.1	General expressions	726
<b>2</b>	<b>Moody's diagram</b>	723	5.1.2	Moody's diagram	726
<b>3</b>	<b>Nomogram for linear head losses in plastic pipes</b>	724	5.1.3	Empirical formulae	728
<b>4</b>	<b>Nomogram for linear head losses in steel pipes</b>	725	5.2	Secondary head losses	728

### 1 Preliminary definitions

#### 1.1 Magnitudes

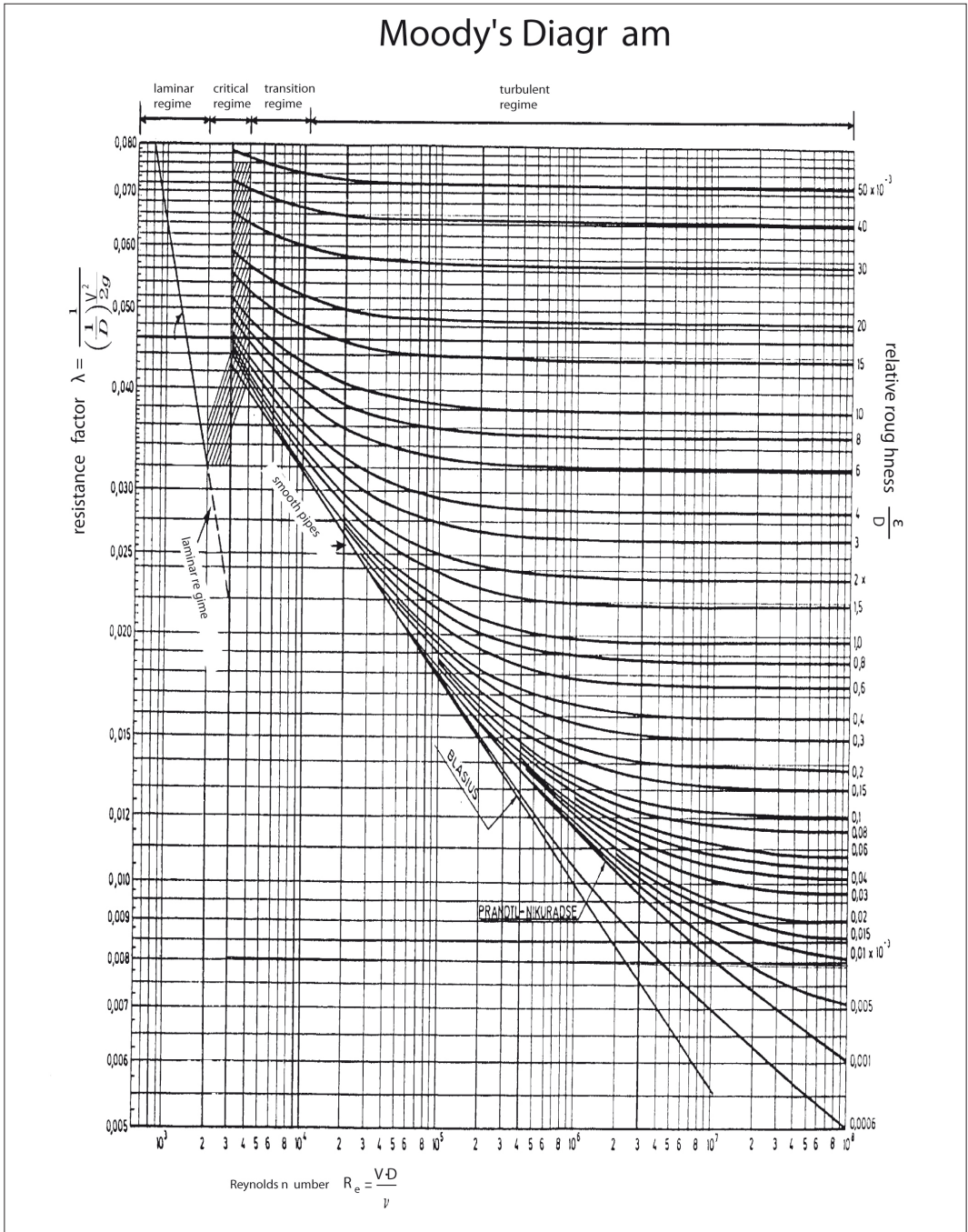
Parameter	Units I.S.	Symbol/Formula	Comments																		
Density	kg.s <sup>2</sup> /m <sup>4</sup>	$\rho$	For water at normal temperatures it is possible to use the value: $\rho = 101.9 \text{ kg.s}^2 / \text{m}^4$																		
Absolute or dynamic viscosity	kg.s / m <sup>2</sup>	$\mu$	For water at atmospheric pressure and at 20°C, the value is: $\mu = 1.025 \times 10^{-4} \text{ kg.s} / \text{m}^2$																		
Kinematic viscosity	m <sup>2</sup> / s	$\nu = \frac{\mu}{\rho}$	The value changes with temperature: <table border="1" style="margin-left: auto; margin-right: auto;"> <tr> <td><math>\nu</math> (m<sup>2</sup>/s)</td> <td></td> </tr> <tr> <td>5</td> <td>1.52 x 10<sup>-6</sup></td> </tr> <tr> <td>10</td> <td></td> </tr> <tr> <td>15</td> <td></td> </tr> <tr> <td>20</td> <td></td> </tr> <tr> <td>25</td> <td></td> </tr> <tr> <td>30</td> <td></td> </tr> <tr> <td>35</td> <td></td> </tr> <tr> <td>40</td> <td></td> </tr> </table> <p>(Normally the value at 20° C is used)</p>	$\nu$ (m <sup>2</sup> /s)		5	1.52 x 10 <sup>-6</sup>	10		15		20		25		30		35		40	
$\nu$ (m <sup>2</sup> /s)																					
5	1.52 x 10 <sup>-6</sup>																				
10																					
15																					
20																					
25																					
30																					
35																					
40																					
Reynolds number	Non-dimensional	$R_e = \frac{DV}{\nu}$ where: D = inside diameter V = velocity	It is important because it determines the range of application for empiric formulas																		

Parameter	Units I.S.	Symbol/Formula	Comments
Absolute equivalent roughness	m	$\varepsilon$	Experimental parameter characteristic for each type of pipe
Relative roughness	Non-dimensional	$\frac{\varepsilon}{D}$	
Friction speed	m/s	$V^* = V \sqrt{\frac{f}{8}}$	
Roughness Reynolds number	Non-dimensional	$(R_e)_r$ or $R_r$ $(R_e)_r = \frac{kV^*}{\nu}$	Used to establish the type of flow regime (see Section 1.2)

## 1.2 Regimes in forced flow

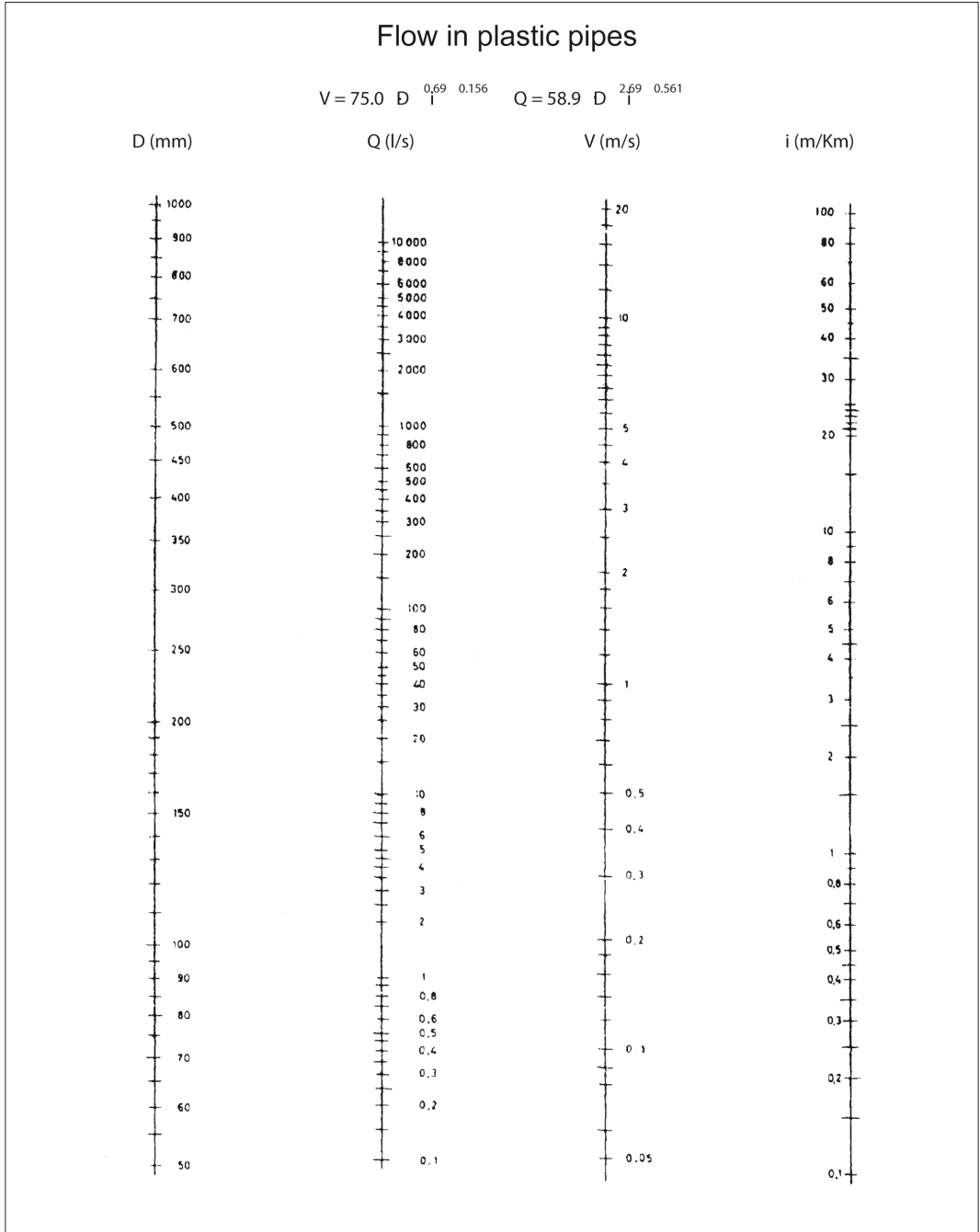
Regime	Re	$(R_e)_r$	What happens
Laminar	$\leq 2\,000$		Viscous forces prevail
Critical	2 000 – 4 000		Not known, not usual
Turbulent			
Smooth	$> 4\,000$	$(R_e)_r \leq 3.5 - 5$	Viscous forces prevail
Intermediate or transition		$5 < (R_e)_r \leq 70$	
Rough		$(R_e)_r > 70$	Inertial forces prevail

## 2 Moody's diagram



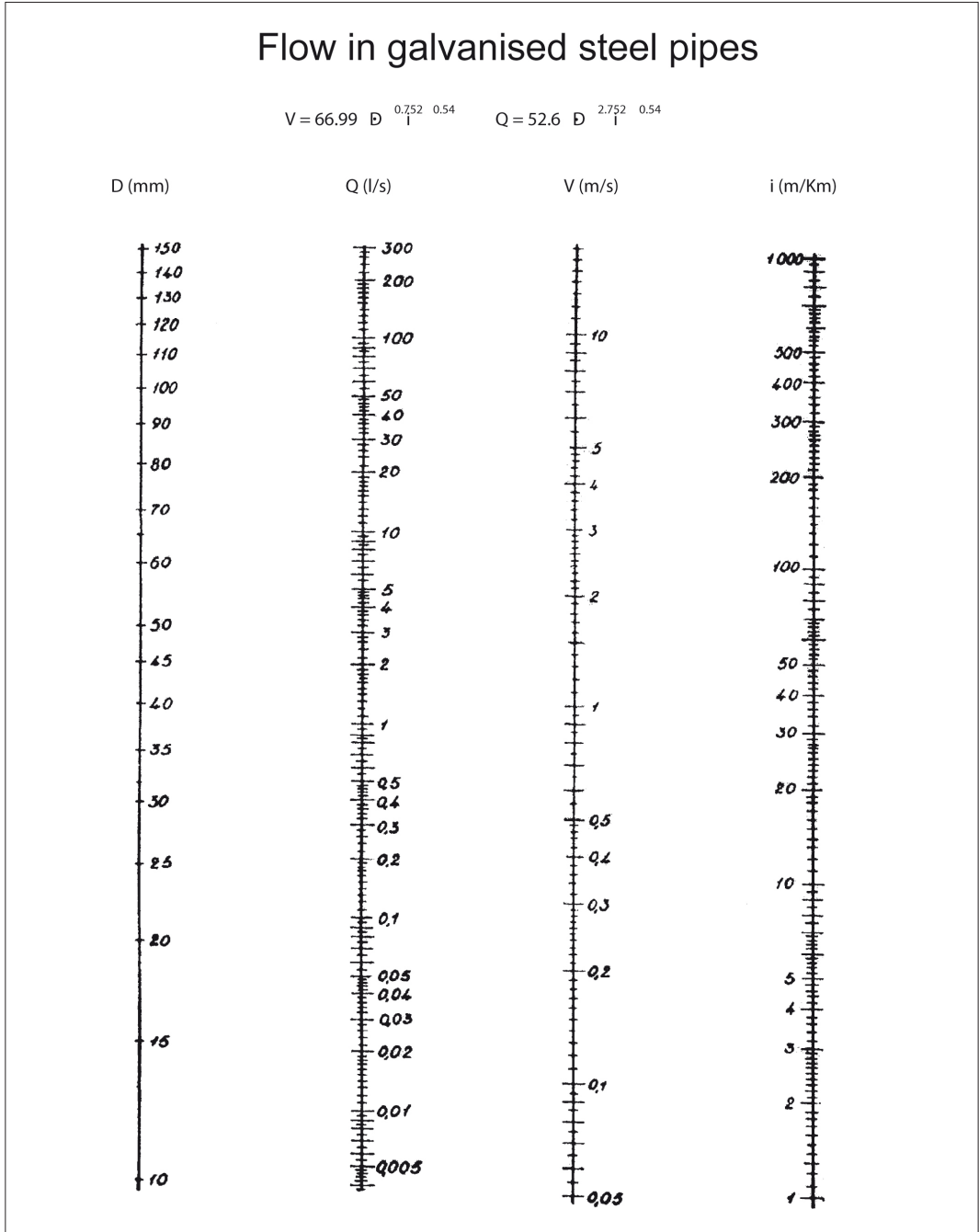
### 3 Nomogram for linear head losses in plastic pipes

#### FLOW IN PLASTIC PIPES



# 4 Nomogram for linear head losses in steel pipes

FLOW IN GALVANISED STEEL PIPES



## 5 Head losses

### 5.1 Linear head losses

#### 5.1.1 GENERAL EXPRESSIONS

The general equation for head losses is written:

$$\Delta H = \lambda \frac{L}{D} \frac{V^2}{2g}$$

where H is head losses (or energy loss) (m),  $\lambda$  head-loss coefficient (non-dimensional), D pipe internal diameter (m), and L pipe length (m).

In a pipe, head losses per unit length, are:

$$\Delta H = \lambda \frac{V^2}{2g D}$$

To calculate linear head losses numerically, the only unknown factor is  $\lambda$ , the head-loss coefficient, which is given by various formulae (Lencastre 1995):

– in laminar regimes:

$$\lambda = \frac{64}{R_e}$$

– in turbulent regimes, for smooth pipes, there are different formulae. One that has been considered valid for a long time is the Blasius equation:

$$\lambda = \frac{0.3164}{R_e^{0.25}}$$

– in turbulent regimes, for rough pipes, the most widely used is the Colebrook-White formula:

$$\frac{1}{\sqrt{\lambda}} = -2 \log_{10} \left[ \frac{\varepsilon}{3.7D} + \frac{2.51}{R_e \sqrt{\lambda}} \right]$$

where  $\varepsilon$  is the absolute roughness of the pipe. Therefore, the only difficulty in the calculation of head losses with this formula resides in the choice of a roughness coefficient  $\varepsilon$ . The values presented in Table I are proposed by Degrémont (1989).

#### 5.1.2 MOODY'S DIAGRAM

Moody established an nomogram where  $\lambda$  is given in terms of  $R_e$  and  $\varepsilon/D$  (the relative roughness), basing his work on a large number of tests, and on the various formulas proposed for the calculation of head losses. This nomogram is important because it can be applied to any fluid, and to any type of flow (laminar, transient or turbulent).

In practice, this is the universal nomogram recommended here. The procedure is as follows:

- calculate  $R_e$ , fixing the flow velocity at 1 m/s;
- calculate the relative viscosity  $\varepsilon/D$ ;
- transfer these two values to Moody's diagram, so that coefficient  $\lambda$  can be worked out;
- calculate head losses using the general formula  $\Delta H = \lambda (L/D) (V^2/2g)$ ;
- for verification,  $\lambda$  is calculated using the Colebrook-White formula. In practice, this formula proves to be valid almost always, and therefore is the best for this kind of calculation. Table II gives  $\lambda/D$  based on the Colebrook-White formula.

**Table I: Values of absolute roughness for different materials (Degrémont 1989).**

Materials	$\epsilon$ in mm
New steel	0.1
New cast iron	0.1 to 1
Plastic	0.03 to 0.1
Concrete - smooth moulds	0.2 to 0.5
Concrete - coarse moulds	1 to 2

**Table II: Coefficient of head losses in pipes.**

Pipe diameter (m)	Coefficient $\lambda/D$ depending on the value of $\epsilon$ (absolute roughness)			
	$\epsilon = 0.1$ mm	$\epsilon = 0.5$ mm	$\epsilon = 1$ mm	$\epsilon = 2$ mm
0.025	1.26	2	2.84	
0.03	1.02	1.54	2.00	2.71
0.04	0.70	1.04	1.34	1.80
0.05	0.528	0.78	0.985	1.3
0.065	0.35	0.50	0.615	0.80
0.08	0.29	0.413	0.512	0.66
0.1	0.222	0.31	0.38	0.49
0.125	0.168	0.232	0.284	0.36
0.150	0.133	0.182	0.223	0.28
0.200	0.0935	0.128	0.153	0.19
0.250	0.071	0.096	0.114	0.141
0.300	0.0573	0.076	0.09	0.11
0.350	0.0475	0.0625	0.0735	0.09
0.400	0.04	0.0530	0.0625	0.0758
0.450	0.0351	0.0460	0.0538	0.065
0.500	0.0308	0.04	0.047	0.0566
0.600	0.0245	0.0322	0.0371	0.0477
0.700	0.0206	0.0266	0.0307	0.0368
0.800	0.0175	0.0225	0.0260	0.0310
0.900	0.0151	0.0194	0.0225	0.0267
1.000	0.0134	0.0170	0.0197	0.0234
1.100	0.01163	0.015	0.01754	0.0209
1.200	0.0104	0.01358	0.01583	0.01875
1.250	0.0102	0.013	0.015	0.0177
1.300	0.00946	0.0123	0.0142	0.01676
1.400	0.00878	0.01128	0.01307	0.01535
1.500	0.00827	0.0104	0.012	0.014
1.600	0.00737	0.00956	0.01106	0.0131
1.700	0.00694	0.00882	0.0103	0.01235
1.800	0.00655	0.00833	0.00966	0.0111
1.900	0.00605	0.00773	0.00894	0.0104
2.000	0.00586	0.00735	0.0084	0.0098



### 5.1.3 EMPIRICAL FORMULAE

To determine linear head losses, there are many nomograms based on empirical formulae. Those found in Lencastre (1995), which contains a great variety of nomograms, allow the calculation of head losses in galvanized steel pipes:

$$V = 66.99 D^{0.752} i^{0.54} \quad \text{and} \quad Q = 52.6 D^{2.752} i^{0.54}$$

and in plastic pipes:

$$V = 75 D^{0.69} i^{0.156} \quad \text{and} \quad Q = 58.9 D^{2.69} i^{0.561}$$

where  $V$  is the water velocity (m/s),  $D$  the internal pipe diameter (mm), and  $i$  the head-loss coefficient (m/km).

## 5.2 Secondary head losses

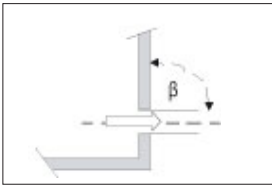
According to Lencastre (1995), the expression for secondary head losses can be written as follows:

$$\Delta H = K \frac{V^2}{2g}$$

where  $K$  is a parameter depending on  $R_e$  and on  $\epsilon$ , but essentially on the geometry of the feature (bend, fitting etc.).

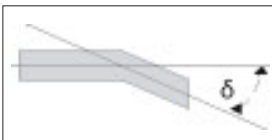
These head losses can be disregarded when the length of the pipe between two features is more than 100 times its diameter.

The main coefficients of secondary head losses are for an abrupt narrowing, such as at a tank outlet (Figure 1), an elbow, (Figure 2), and a tee (Figure 3).



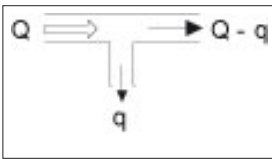
**Figure 1: Head-loss coefficient as a function of angle  $\beta$  between the pipe and the wall at outlet from a tank.**

$\beta$	20°	30°	45°	60°	70°	80°	90°
$K$	0.96	0.91	0.81	0.70	0.63	0.56	0.50



**Figure 2: Head-loss coefficient as a function of angle  $\delta$  of a bend.**

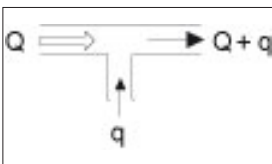
$\delta$	22.5°	30°	45°	60°	75°	90°
$K$	0.17	0.20	0.45	0.70	1	1.50



**Figure 3: Head-loss coefficient as a function of the division of flow in a tee.**

**A: flow out Q. B: flow in Q.**

A		0	0.1	0.2	0.3	0.4	0.5	0.6	0.7	0.8	0.9	1
$q/Q$												
$K_q$			1	1.01	1.03	1.05	1.09	1.15	1.22	1.32	1.38	1.40
$K_{Q-q}$		0	0.004	0.02	0.04	0.06	0.10	0.15	0.20	0.26	0.32	



B		0	0.1	0.2	0.3	0.4	0.5	0.6	0.7	0.8	0.9	1
$Q/(Q+q)$												
$K_q$			-0.37	-0.18	-0.07	0.26	0.46	0.62	0.78	0.94	1.08	1.20
$K_{Q+q}$		0	0.16	0.27	0.38	0.46	0.53	0.57	0.59	0.60	0.59	0.50

# B UNITS OF MEASUREMENT

1	<b>Main units</b>	729
2	<b>Prefixes for multiples and sub-multiples of units</b>	731
3	<b>Imperial and US customary units and conversions</b>	732

## 1 Main units

SI units are given in bold.

Magnitude	Unit	Standard symbol	Expression in base units	Expression in other units
<b>SPACE</b>				
<b>Length</b>	<b>metre</b>	<b>m</b>		
	micron	$\mu\text{m}$	$10^{-6} \text{ m}$	
	inch	in or "	$2.54 \times 10^{-2} \text{ m}$	
Area	square metre	$\text{m}^2$		
	are	a	$100 \text{ m}^2$	
	hectare	ha	$10\,000 \text{ m}^2$	
	acre	ac	$4\,047 \text{ m}^2$	
Volume	cubic metre	$\text{m}^3$		
	litre	l		$10^{-3} \text{ m}^3 - 1 \text{ dm}^3$
Plane angle	radian	rad		
	degree	$^\circ$		$(\pi/180) \text{ rad}$
	minute	'		$(1/60)^\circ$
	second	"		$(1/60)'$
	grade	gr		$(\pi/200) \text{ rad}$
<b>TIME</b>				
<b>Time</b>	<b>second</b>	<b>s</b>		
	minute	min	60 s	
	hour	h	3 600 s	
	day	d	86 400 s	
	year	y	$3.16 \times 10^7 \text{ s}$	
Frequency	hertz	Hz	$\text{s}^{-1}$	
<b>MASS</b>				
<b>Mass</b>	<b>kilogram</b>	<b>kg</b>		
Density	kilogram per cubic metre	$\text{kg.m}^{-3}$		
Specific volume	cubic metre per kilogram	$\text{m}^3.\text{kg}^{-1}$		
<b>SPEED</b>				
Velocity	metre per second	$\text{m.s}^{-1}$		
Angular velocity	radian per second	$\text{rd.s}^{-1}$		
<b>MECHANICS</b>				
Acceleration	metre per second squared	$\text{m.s}^{-2}$		
Force, weight	newton	N	$\text{m.kg.s}^{-2}$	
	dyne	dyn		$10^{-5} \text{ N}$
	kilogram-force	kgf		9.81 N
Moment of a force	newton per metre	N.m	$\text{kg.m}^2.\text{s}^{-2}$	

Magnitude	Unit	Standard symbol	Expression in base units	Expression in other units
<b>MECHANICS</b>				
Energy, work, heat	joule	J	$m^2.kg.s^{-2}$	
	kilogram metre	kgm		9.81 J
	calorie (small)	cal <sub>15</sub>		4.1855 J
	calorie (large)	cal		4.1868 J
	kilocalorie	kcal		4 186.8 J
	watt-hour	Wh		3 600 J
Mass flow	electron volt	eV	$m^2.kg.s^{-3}$	$1.60219 \times 10^{-19} J$
	kilogram metre per second	kg.m.s <sup>-1</sup>		
Power	watt	W		N.m.s <sup>-1</sup> –J.s <sup>-1</sup>
	metric horsepower	HP		735.499 W
Thermal flux	watt per square metre	W.m <sup>-2</sup>		
Pressure, stress	pascal	Pa	$m^{-1}.kg.s^{-2}$	N.m <sup>-2</sup>
	bar	bar		105 Pa
	normal atmosphere	atm		101 325 Pa
	millimetre of water	mmH <sub>2</sub> O		9.81 Pa
	millimetre of mercury	mmHg		133.322 Pa
Dynamic viscosity	pascal second	Pa.s		
	poise	P		10 <sup>-1</sup> Pa.s
	poiseuille	PI		1 Pa.s
Kinematic viscosity	square metres per second	m <sup>2</sup> .s <sup>-1</sup>		
	stokes	St	10 <sup>-4</sup> m <sup>2</sup> .s <sup>-1</sup>	
<b>Thermodynamic temperature</b>	<b>kelvin</b>	<b>K</b>		
<b>HEAT</b>				
Temperature, Celsius	degree celsius	°	+ 273.15	T (°C) = T (K)
Thermal capacity	joule per kelvin	J.K <sup>-1</sup>		
Thermal conductivity	watt per metre kelvin	W.m <sup>-1</sup> .K <sup>-1</sup>		
<b>OPTICS</b>				
<b>Luminous intensity</b>	<b>candela</b>	<b>cd</b>		
Luminous flux	lumen	lm		cd.sr
Illuminance	lux	lx		lm.m <sup>-2</sup>
Luminance	candela per square metre	cd.m <sup>-2</sup>		
	lambert	L		$3.183 \times 10^3 cd.m^{-2}$
<b>MAGNETISM–ELECTRICITY</b>				
<b>Electric current intensity</b>	<b>ampere</b>	<b>A</b>		
Electric charge	coulomb	C	A.s	
	faraday			$9.64870 \times 10^4 C$
Voltage, potential	volt	V	$m^2.kg.s^{-3}.A^{-1}$	W.A <sup>-1</sup>
Electric field	volt per metre	V.m <sup>-1</sup>		
Electric capacitance	farad	F	$m^{-2}.kg^{-1}.s^4.A^2$	C.V <sup>-1</sup>
Electric energy	kilowatt-hour	kWh		$3.6 \times 10^6 J$
Magnetic field	ampere per metre	A.m <sup>-1</sup>		
Magnetic induction	tesla	T	$kg.s^{-2}.A^{-1}$	Wb.m <sup>-2</sup>
	gauss	G		10 <sup>-4</sup> T
Magnetic induction flux	weber	Wb	$m^2.kg.s^{-2}.A^{-1}$	V.s
	maxwell	Mx		10 <sup>-8</sup> Wbs
Inductance	henry	H	$m^2.kg.s^{-2}.A^{-2}$	Wb.A <sup>-1</sup>
Resistance, impedance	ohm	Ω	$m^2.kg.s^{-3}.A^{-2}$	V.A <sup>-1</sup>
Conductance	siemens	S	$m^{-2}.kg^{-1}s^3.A^{-2}$	A.V <sup>-1</sup> – Ω <sup>-1</sup>
Resistivity	mho	mho		S <sup>-1</sup>
	ohm metre	Ω.m	$m^3.kg.s^{-3}.A^{-2}$	
Conductivity	siemens per metre	S.m <sup>-1</sup>	$m^{-3}.kg^{-1}s^3.A^{-2}$	

Magnitude	Unit	Standard symbol	Expression in base units	Expression in other units
<b>CHEMISTRY- PHYSICS</b>				
Amount of substance	mole	mol		$6.023 \times 10^{23}$ atoms
Molar mass	kilogram per mole	$\text{kg.mol}^{-1}$		
Molar volume	cubic metre per mole	$\text{m}^3.\text{mol}^{-1}$		
Density	kilogram per cubic metre	$\text{kg.m}^{-3}$		(number of mole x molar mass) / volume of the solution
	part per million	ppm		(number of mole x molar mass) / mass of the solution
	milli-equivalent per litre	$\text{meq.l}^{-1}$		(number of mole x ionic charges) / volume of the solution
Molar concentration, molarity	mole per cubic metre	$\text{mol.m}^{-3}$		number of mole / volume of the solution
Molality	mole per kilogram	$\text{mol.kg}^{-1}$		number of mole / mass of the solution

## 2 Prefixes for multiples and sub-multiples of units

Factor multiplier	Prefix	Symbol
$10^{12}$	tera	T
$10^9$	giga	G
$10^6$	mega	M
$10^3$	kilo	k
$10^2$	hecto	h
10	deca	da
$10^{-1}$	deci	d
$10^{-2}$	centi	c
$10^{-3}$	milli	m
$10^{-6}$	micro	$\mu$
$10^{-9}$	nano	n
$10^{-12}$	pico	p
$10^{-15}$	femto	f
$10^{-18}$	atto	a

### 3 Imperial and US customary units and conversions

Unit	Symbol	Remarks	Conversion
<b>LENGTH</b>			
inch	in or "		1 in = 0.0254 m
foot	ft or '	1 ft = 12 in	1 ft = 0.3048 m
mile	mi	1 mi = 1 760 yds	1 mi = 1 609.35 m
yard	yd	1 yd = 3 ft	1 yd = 0.9144 m
<b>AREA</b>			
square inch	sq in		1 sq in = $6.452 \cdot 10^{-4}$ m <sup>2</sup>
square foot	sq ft	1 sq ft = 144 sq in	1 sq ft = 0.0929 m <sup>2</sup>
acre	ac	1 ac = 4 840 yd <sup>2</sup>	1 ac = 4 047 m <sup>2</sup>
<b>VOLUME</b>			
imperial pint	UK pt		1 UK pt = 0.5683 l
imperial gallon	UK gal	1 UK gal = 8 UK pts	1 UK gal = 4.546 l
US liquid pint	US pt		1 US pt = 0.473 l
US gallon	US gal	1 US gal = 8 US pt	1 US gal = 3.785 l
cubic foot	cu ft		1 cu ft = $2.832 \times 10^{-2}$ m <sup>3</sup>
<b>FLOW</b>			
imperial gallons per second	UK gps		1 imp gps = $4.546 \times 10^{-3}$ m <sup>3</sup> .s <sup>-1</sup>
US gallons per second	US gps		1 US gps = $3.785 \times 10^{-3}$ m <sup>3</sup> .s <sup>-1</sup>
cubic feet per second	ft <sup>3</sup> .s <sup>-1</sup>		1 ft <sup>3</sup> .s <sup>-1</sup> = $2.832 \times 10$ m <sup>3</sup> .s <sup>-1</sup>
<b>MASS</b>			
ounce	oz		1 oz = 28.350 g
pound	lb	1 lb = 16 oz	1 lb = 453.592 g
long ton (UK)	UK ton	1 UK ton = 2 240 lb	1 UK ton = 1 016 kg
short ton (US)	US ton	1 US ton = 2 000 lb	1 US ton = 907 kg
<b>FORCE</b>			
pound force	lbf		1 lbf = 0.0448 N
poundal	pdl		1 pdl = 0.138 N
<b>PRESSURE</b>			
pound force per square inch	psi		1 psi = 6 894.76 Pa
<b>ENERGY</b>			
British thermal unit	BTU		1 BTU = 1 055.06 J

# Water-treatment products files

---

<b>1</b>	<b>Disinfection products</b>	733
<b>2</b>	<b>Flocculation products</b>	734

---

## 1 Disinfection products

### CALCIUM HYPOCHLORITE–HTH AT 65% ACTIVE CHLORINE

---

Indicative price	3 to 6 €/kg for 1 t in drums of 50 kg each
Appearance	Whitish granules
Apparent density	0.9 to 1.0 kg/l
Solubility in water at 27° C	217 g/l
Grain size	1 - 2.5 mm
Application	The product keeps well (with a loss of 2% of active chlorine per year) in a non-metallic, sealed container, away from light and heat Very corrosive, subject to strict air-transport regulations Special packaging required

---

### TRICHLOROCYANURATE TCCA (CITERNET) AT 90% ACTIVE CHLORINE

---

Indicative price	3 to 4.50 € per 70 g float in a pallet
Appearance	Solid white tablets
Smell	Chlorine
Solubility in water at 20° C	12 g/l
Tablet dissolution duration	2 to 4 weeks
Capacity	One 35 g tablet for the treatment of 3 000 l of water
Application	Available in the form of a light PVC float with two pods, each containing one 35 g float tablet to be thrown into the water after opening Treatment for a limited period of time (maximum 3 months) Avoid long-term use

---

### SODIUM DICHLORO-ISOCYANURATE (NADCC)

---

Appearance	Effervescent tablets which liberate hypochlorous acid
Capacity	Tablets at 3.5 to 8 680 mg for the treatment of 1 to 2 500 l of water
Application	Convenient, efficient, particularly in emergencies Same restrictions in duration of use as for TCCA Permissible for air freight

---

## 2 Flocculation products

### ALUMINIUM SULPHATE AT 17% $Al_2SO_3$

---

Indicative price	4 € per kg in paper bags of 50 kg
Appearance	Blocks, bars, granules, powder
Solubility	688 g/l
Density	1 t/m <sup>3</sup>
Application	50 kg of product can treat 300 to 2 500m <sup>3</sup> of water Application range pH 6-8

---

### IRON SULPHATE AT 90% $Fe_2(SO_4)_3$ OR 26% FE

---

Appearance	Granules, crystals, lumps
Application	Wider application range than aluminium sulphate (pH 4.5-9) Storage in waterproof drums protected against humidity Use containers protected against corrosion Risk of coloration if raw water has a high organic-matter content

---

# Civil engineering

<b>1</b>	<b>Mortar, masonry, concrete and steel reinforcement</b>	735	<b>3</b>	<b>Further information</b>	757
1.1	Mortar	736	3.1	Stresses in structures and type of reinforcement	757
1.1.1	<i>Applications and mixes</i>	736	3.1.1	<i>Beams and slabs on free supports</i>	758
1.1.2	<i>Use and precautions</i>	737	3.1.1.1	Positioning of the reinforcement depending on the stresses	758
1.2	Masonry	737	3.1.1.2	Extension to the case of a full slab supported by 2 walls (cover)	759
1.2.1	<i>Applications</i>	737	3.1.2	<i>Pillars and walls</i>	759
1.2.2	<i>Use and precautions</i>	737	3.2	Calculation of structures and common jobs in reinforced concrete	759
1.2.3	<i>Prefabricated mortar blocks</i>	737	3.2.1	<i>Introduction and methodology</i>	759
1.3	Concrete	740	3.2.2	<i>Examples of application</i>	760
1.3.1	<i>Applications</i>	740	3.2.2.1	Assumed stress limits for materials	760
1.3.2	<i>Mixes</i>	740	3.2.2.2	Sizing of concrete sections	761
1.3.3	<i>Estimating quantities of material needed</i>	741	3.2.2.3	Forces applied to structures and resulting stresses (moments)	761
1.3.4	<i>Water content in concrete, separation</i>	741	3.2.2.4	Stresses in structures, bending moments	762
1.3.5	<i>Use and precautions</i>	741	3.2.3	<i>Design calculation examples</i>	763
1.3.6	<i>Concrete joints</i>	742	3.2.3.1	Pillars	763
1.4	Steel for reinforced concrete	743	3.2.3.2	Slabs in simple flexion	764
1.4.1	<i>Properties of reinforcement steels</i>	744	3.2.3.3	Economic design of reinforced-concrete tanks	765
1.4.2	<i>Placing, anchorage, overlaps</i>	744	3.2.3.4	Circular tank	766
<b>2</b>	<b>Rapid structural calculations</b>	745	3.2.3.5	Rectangular tank	767
2.1	Load calculations	745	3.2.3.6	Elevated rectangular tank	768
2.2	Reinforced-concrete elements	745	3.2.3.7	Reinforced-concrete retaining walls	769
2.2.1	<i>Definitions</i>	745	3.2.3.8	Simplified calculation of a retaining wall in reinforced concrete	771
2.2.2	<i>Pillars</i>	746	<b>4</b>	<b>Shuttering</b>	772
2.2.3	<i>Beams</i>	747	4.1	Wooden shuttering	772
2.2.4	<i>Slabs</i>	747	4.2	Metal shuttering, well moulds	773
2.2.4.1	Rectangular slab on free supports (2 walls)	748	<b>5</b>	<b>Estimation of work time</b>	773
2.2.4.2	Base (ground slab)	748			
2.2.4.3	Cover slab for water tank	749			
2.2.5	<i>Retaining walls</i>	749			
2.2.6	<i>Foundations</i>	750			
2.2.7	<i>Water tanks</i>	751			
2.2.7.1	Circular water tanks	751			
2.2.7.2	Rectangular tanks	752			
2.3	Standard jobs in masonry	753			
2.4	Water-point surface works	754			

## 1 Mortar, masonry, concrete and steel reinforcement

Mortar and concrete are essential building materials. Combined with steel and stone, they make up reinforced concrete and masonry.



The densities of different construction materials are given in Table I:

- mortar: mixture of cement/sand/water;
- concrete: mixture of cement/sand/gravel/water.

**Table I: Densities of several building materials.**

Sand	1 600 kg/m <sup>3</sup>	Masonry, stone	2 500 kg/m <sup>3</sup>
Gravel	1 800 kg/m <sup>3</sup>	Masonry, hollow block	1 500 kg/m <sup>3</sup>
Cement	1 440 kg/m <sup>3</sup>	Masonry, solid block	2 150 kg/m <sup>3</sup>
Cement mortar	2 000 kg/m <sup>3</sup>	Masonry, hollow brick	1 400 kg/m <sup>3</sup>
Reinforced concrete	2 500 kg/m <sup>3</sup>		

Volumetric measurements are usually quoted in the UK and USA (a 50-kg bag of cement has a volume of 35 l) as follows:

1:3 mortar – 1 volume of cement per 3 volumes of sand;

1:2:4 concrete – 1 volume of cement per 2 volumes of sand and 4 of gravel.

The following denomination is commonly used on building sites: 1 bag of cement per 3 barrows of sand; 1 bag of cement per 2 barrows of sand and 4 of gravel. This does not correspond to the UK/US quantities quoted above.

## CHOICE OF INGREDIENTS

*Cement:* the most common used cement is Portland. It should be dry, powdery and free of lumps. When storing cement, try to avoid all possible contact with moisture. Store away from exterior walls, off damp floors, and stacked close together to reduce air circulation.

*Water:* in general, water fit for drinking is suitable for mixing concrete. Impurities in the water may affect concrete setting time, strength and shrinkage, or promote corrosion of reinforcement.

*Sand:* sand should range in size from less than 0.25 mm to 6.3 mm. Sand from beaches, dunes or river banks is usually too fine for normal mixes.

*Gravel:* optimum gravel size in most situations is about 2 cm.

*Note.* – It is extremely important to have clean sand and gravel. Even small amounts of silt, clay or organic matter will ruin concrete. A very simple test for cleanliness is done with a clear wide-mouthed jar. Fill the jar about half full of the sand to be tested, and cover with water. Shake the mixture vigorously, and then allow it to stand for three hours. In almost every case there will be a distinct line dividing the fine sand suitable for concrete and that which is too fine. If the very fine material amounts to more than 10% of the suitable material, then the concrete made from it will be weak. This means that other fine material should be sought, or the available material should be washed. Sand and gravel can be washed by putting it in a container such as a drum. Cover the aggregate with water, stir thoroughly, let it stand for a minute, and pour off the liquid. One or two such treatments will remove most of the very fine material and organic matter.

## 1.1 Mortar

### 1.1.1 APPLICATIONS AND MIXES

- Building masonry walls
- Coatings, various small jobs in gaps, sealing
- Manufacture of cement blocks
- Different cement/sand ratios are used depending on application (Table II, Box 1).

**Table II: Mixes for cement mortars.**

Type of mortar	Cement (kg)	Sand (l)* 0.1 - 5 mm	UK/US denomination
Weak mortar	200 (4 bags)	1 120	1:8
Medium mortar (rough plaster, masonry mortar)	300 (6 bags)	1 260	1:6
Strong mortar (smooth plaster-bedding)	400 (8 bags)	1 120	1:4

\* 1 m<sup>3</sup> of aggregates makes up 1 100 to 1 200 l when expanded.

### 1.1.2 USE AND PRECAUTIONS

The mix must be homogeneous and prepared in an appropriate area (on a concrete slab, board etc.). The usual procedure is to turn the heap of sand to which the cement has been added until it is thoroughly mixed.

It is advisable to wet only the quantity of mortar to be used in the next half hour, because mortar is difficult to work after that time.

The amount of water needed depends on the cement mix and the wetness of the sand. Approximately 200 litres of water are necessary to obtain 1 m<sup>3</sup> of mortar mixed at 300 kg cement/m<sup>3</sup>.

The correct quantity of water is chosen to obtain a plastic mortar: to check the proportions, the mortar is smoothed with a trowel: it should shine, but there must be no free water. Too much water may cause serious shrinkage and cracks (see Box 2). Mortar must be sheltered from sun and wind to avoid drying too fast.

## 1.2 Masonry

### 1.2.1 APPLICATIONS

- All major and minor jobs: foundations, walls, pillars etc.
- Advantages: use of materials sometimes available on site, and technology which is often mastered locally.
- Limitations: for large jobs (large capacity water tanks, retaining walls), it requires large quantities of materials.

### 1.2.2 USE AND PRECAUTIONS

- Dry stone (cut or rough), prefabricated building blocks (concrete or mortar), or clay bricks, can be used. Clean and previously wetted stones should be used:
  - about 25% of mortar for 75% of bricks or building blocks;
  - about 30% to 35% of mortar for 70 to 65% of stones.
- Medium mortar is used (300 kg of cement/m<sup>3</sup>) for joints.

### 1.2.3 PREFABRICATED MORTAR BLOCKS

It is very useful to manufacture blocks with a specialist team, to supply a large number of sites, and help to build a stock for future jobs. The rainy season is a good period for this work because large amounts of water are needed for watering the blocks (for curing).

**Box 1**  
**Cement.**

Cement is produced by firing argillaceous limestone rocks, or a mixture of clay and limestone (5 to 25% clay, 75 to 95% limestone) at high temperatures (1 400 °C). Once calcined, the mixture is finely ground.

The addition of water to the cement causes a chemical reaction (hydration): the calcium silicates and calcium aluminates change, and become cement hydrates with the formation of crystals. This precipitate of micro-crystals is what causes the setting phenomenon: the hardening phase is simply the continuation of the crystal-formation process.

Setting and hardening are assisted by humidity and high temperatures. In normal conditions (depending on temperature and mix), approximate times are:

- 30 mins to 1 h for setting: then the concrete loses its plasticity;
- 4 hours until the setting process ends: then the concrete cannot be worked;
- finally, hardening occurs. This can take from 6 months to 1 year.

Concrete, like mortar, changes over time. Concrete becomes resistant when it hardens (Table I). Cements are characterised by their setting speed, and particularly by their compressive resistance (in bar), at 7 and 28 days of hardening.

**Table I: Resistance increase during the hardening period.**

Duration	Total resistance (%)
3 days	20
17 days	45
28 days	60
3 months	85
6 months	95
1 year	100

A rough general classification is:

- slow-setting cement (artificial Portland artificial cements, APC);
- ordinary cement;
- high-resistance cement;
- quick-setting cement for specific jobs (in contact with water, for sealing, etc.), which is less resistant than standard cement (80 kg/cm<sup>2</sup> at 28 days, compared with 250 kg/cm<sup>2</sup> for ordinary cement).

Generally, cement type (APC, CPJ etc.), and resistance code (35, 45 etc.) are marked on the bags (sometimes resistance at 7 and 28 days is also marked). Bags generally carry a more or less explicit designation of the type of cement and its resistance.

Most standard cements are APC or CPJ, in resistance class 35 or 45, i.e. with respective resistances of 350 and 450 kg/cm<sup>2</sup>.

In theory, a specific cement is chosen depending on its use, but in practice, generally only one type of cement is available. Therefore, the mix is what varies, rather than the type of cement: for example, the quantity of cement is greater in concrete for making a cutting ring for well digging (350 to 400 kg cement/m<sup>3</sup>) than for making concrete slabs (200 to 250 kg/m<sup>3</sup>).

The way cement is stored greatly affects its properties: cement absorbs ambient humidity easily, resulting in resistance loss if stored carelessly or for too long (about 40% less resistant after 12 months of incorrect storage).

## Box 2

### Shrinkage.

Controlling shrinkage plays an important part in the proper utilisation of cement. Shrinkage is partly a thermal process, but primarily a hydraulic one (water evaporation), which causes cracks in mortars and concretes. This hydraulic shrinkage continues for a long time after the mortar or concrete has been laid (Table I).

Some reasons for excessive shrinkage are:

- too much water (the excess water cannot be used in the reaction and can only evaporate, causing hydraulic shrinkage);
- poor cement curing (also involving excessive evaporation);
- high cement/aggregate mix (400/500 kg cement/m<sup>3</sup> for very rich concrete and mortars);
- irregular aggregate grain size.

**Table I: Effective shrinkage period (good water proportion, temperature not too high).**

Duration (days)	Shrinkage (mm/m)
2 days	0.04
7 days	0.13
28 days	0.27
3 months	0.4
1 year	0.42
3 years	0.45

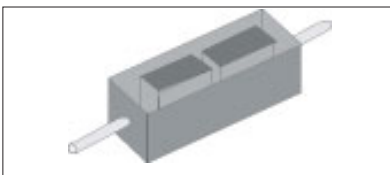
A typical team for a block workshop is made up of 1 mason and 6 labourers, divided into three groups:

- 3 labourers for mixing mortar,
- 2 labourers for casting blocks,
- 1 labourer responsible for watering and storing the blocks.

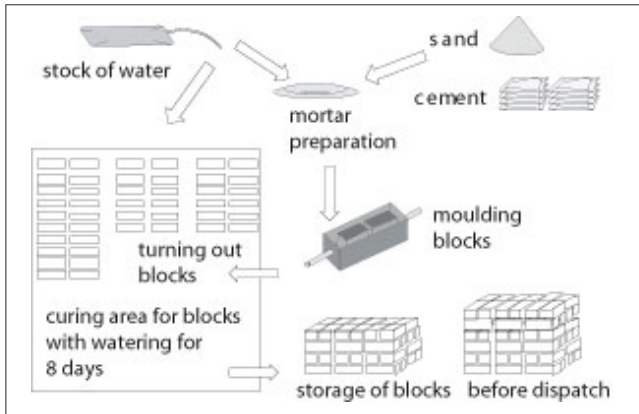
Quantities of materials and output are given in Table III. Moulds are made of metal, and require a trained welder for their manufacture (Figure 1). These moulds are greased with used oil to facilitate release of the blocks. Normally two types of blocks, of different sizes (Table IV), are manufactured. An example of a block workshop is given in Figure 2.

**Table III: Quantities and output for the manufacture of mortar blocks.**

Bags of cement (50 kg)	Volume of sand (l)	Volume of water (m <sup>3</sup> ) (including watering)	Number of blocks
1	140	0.04	20 to 25
16	2 400	2	400
Output	400 blocks/day with a well-organised team		
Losses (broken blocks)	5 to 10%		



**Figure 1: Mould for mortar blocks.**



**Figure 2: Plan of a mortar block workshop.**

**Table IV: Common measurements for mortar blocks.**  
W, width. H, height. L, length.

W	H	L (cm)	W	H	L (inches)	Use
15	20	40	6"	8"	16"	Load-bearing walls
10	20	40	4"	8"	16"	Partition walls

## 1.3 Concrete

### 1.3.1 APPLICATIONS

A distinction can be made between mass concrete and reinforced concrete. Mass concrete works only in compression, whereas reinforced concrete works in both compression and tension (reinforcement steel resists tensile stresses). This is why reinforced concrete is used in such a wide range of applications – foundations, retaining walls, and other structures such as platforms, slabs, pillars or beams, and special applications such as well linings, concrete rings, headwalls etc.

### 1.3.2 MIXES

The standard mix for concrete (Table V) is 300 kg of cement per m<sup>3</sup> of aggregate, containing 1 volume of sand for 2 volumes of gravel, which means in practice 1 bag of cement for 1 barrow of sand and 2 of gravel. A higher cement content gives higher compressive resistance (Table VI), but shrinkage increases (see Box 2).

**Table V: Mixes for concrete.**

Type	Cement (kg)	Sand (l)* 0.1 - 5 mm	Gravel (l)* 6 - 25 mm	UK/US denomination
Reinforced concrete in severe conditions	400	400	800	1 : 1.5 : 3
Standard (pump bases, aprons, beams, etc.)	300 to 350	400	800	1 : 2 : 4
Foundations and pipe surrounds	200 to 250	400	800	1 : 3 : 6

\* 1 m<sup>3</sup> of aggregates make up 1 100 to 1 200 l when expanded.

**Table VI: Effect of cement content on resistance at 28 days.**

Mix (kg/m <sup>3</sup> )	Resistance to compression (bars)	Resistance to tension (bars)
300	210	20
350	250	22
400	280	24

### 1.3.3. ESTIMATING QUANTITIES OF MATERIAL NEEDED

- a) Calculate the volume of concrete needed.
- b) Estimate the total volume of lease material needed by multiplying the required volume of concrete by 1.65 (this includes 10% extra to compensate for losses).
- c) Add the numbers in the volumetric proportion that you will use to get a relative total. This will allow you later to compute fractions of the total needed for each ingredient. (i.e. 1:2:4 = 7).
- d) Determine the required volume of cement, sand and gravel by multiplying the total volume of dry material (Step B) by each component's fraction of the total mix volume (Step C) i.e. the total amount of cement needed = volume of dry materials x 1/7.
- e) Calculate the number of bags of cement by dividing the required volume of cement by the unit volume per bag (0.0332 m<sup>3</sup> per 50-kg bag of cement or 1 ft<sup>3</sup> per 94-lb bag).

For example, for a 2 m x 2 m x 10 cm thick pump pad:

- a) Required volume of concrete: 0.40 m<sup>3</sup>
- b) Estimated volume of dry material:  $0.4 \times 1.65 = 0.66 \text{ m}^3$
- c) Mix totals:  $1 + 2 + 4 = 7$  (1:2:4 cement + sand + gravel)
- d) Ingredient volumes:
  - $0.66 \times 1/7 = 0.094 \text{ m}^3$  cement
  - $0.66 \times 2/7 = 0.188 \text{ m}^3$  sand
  - $0.66 \times 4/7 = 0.378 \text{ m}^3$  gravel
- e) Number of bags of cement:  $0.094 \text{ m}^3 \text{ cement} / 0.0332 \text{ m}^3 \text{ per } 50\text{-kg bag} = 2.83 \text{ bags of cement (use three bags)}$

### 1.3.4 WATER CONTENT IN CONCRETE, SEPARATION

The functions of the water are to hydrate the cement, to wet the aggregate, and to ensure sufficient plasticity in mortar and concrete. Depending on the application and the quantity of cement, a certain quantity of water is added; for example, concrete is 'wetted' more to slide it into shuttering with reinforcement than to cast a footing.

The quantity of water used in the preparation of concrete also affects separation, i.e. the loss of homogeneity of the material and consequently reduced resistance. If no precautions are taken, the constituent elements of concrete (gravels, sand, cement), which have very different densities, tend to separate, the heaviest falling to the bottom and the lightest remaining at the surface.

### 1.3.5 USE AND PRECAUTIONS

Mixing is carried out on a well-prepared area (e.g. a concrete slab), where the procedure is to dry-mix the cement, sand, and gravel, turning over the heap regularly.

Once the dry materials are properly mixed, a crater is prepared, into which a suitable quantity of water is poured.

The water is allowed to disperse before beginning the wet mixing, which ensures the plasticity of the concrete.

The quantity of water required can be calculated from Table VII.

**Table VII: Volume of water for 1 m<sup>3</sup> of concrete at 350 kg cement/m<sup>3</sup> (dry aggregates).**

Volume of water (l)	Quality of concrete	Water/cement (l/kg)
151	Very firm	0.43
175	Firm	0.50
200	Plastic	0.57
221	Soft	0.63
231	Too soft	0.66

Some appropriate precautions to take are:

- do not add too much water, to avoid excessive shrinkage and separation of the concrete;
- protect cast concrete from sun and wind (plastic sheeting, cement bags, mats etc.), and moisten exposed surfaces, covers, and shuttering, to ensure slow drying and sufficient humidity for the chemical reaction of hardening to continue;
- stick to the correct times for removal of moulds and shuttering (Table VIII);
- allow sufficient time before putting the structure into service, e.g. generally 28 days for filling tanks with water;
- ensure correct joints between casting stages (successive stages should be cast no more than 24 hours after the previous one, casting onto a clean and roughened surface);
- vibrate the concrete well to compact it;
- work at temperatures higher than 5 °C.

**Table VIII: Time required before removing shuttering at 18 °C for standard concrete. For water tanks built in several stages, the rule is to cast one stage per day.**

Tank walls, well rings etc.	24 hours
Slabs cast <i>in situ</i>	2 to 3 days
Prefabricated slabs	3 days

### 1.3.6 CONCRETE JOINTS

Good joints between successive concrete pours are very important for the solidity and impermeability of a structure. The conditions for a good joint are: a correct angle of joint, a well-prepared surface, and a very short delay between successive pours (Table IX).

The correct angle of joint varies depending on the type of stress undergone by the structure (Figure 3).

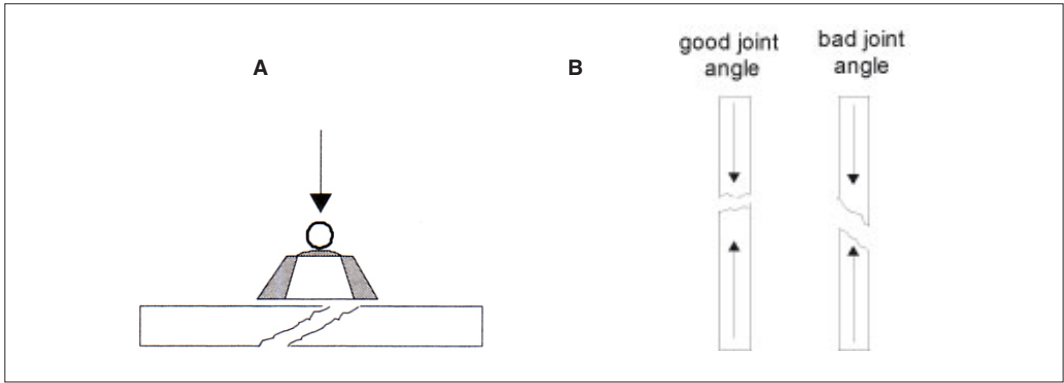
For a load-bearing wall or partition wall under vertical stress, joints are perpendicular, whereas for a floor or the walls of a water-tank, angled sides are preferable.

To guarantee good adhesion, it is necessary to roughen the surface of the joint to provide a key. The roughened surface is then brushed to remove rubble and dust, and the surface of the joint moistened before pouring.

Some additives, such as Sikalutex, improve adhesion (Box 3).

**Table IX: Resistance of a concrete joint.**

Delay between successive pours	Resistance of the joint
1 day	325 kg/cm <sup>2</sup>
7 days	210 kg/cm <sup>2</sup>
18 days	65 kg/cm <sup>2</sup>



**Figure 3: Concrete joints.**  
**A: joint in a floor. B: joint in a wall under vertical load.**

**Box 3**  
**Concrete additives.**

There are a large number of additives for concrete and mortar: liquefiers and plasticisers, waterproofing agents, setting accelerators, setting inhibitors, antifreeze etc. Two products widely used in water-supply structures are the liquid waterproofing Sika, and Sikalatex.

*Liquid waterproofing Sika*

This additive is used to make waterproof mass concrete (use for walls and floors of water tanks), as well as concretes resistant to water containing gypsum, or sea water. It comes in the form of a white liquid concentrate in 210-kg drums, which must be stored away from the sun.

Sika liquid waterproofing is added to concrete with the mixing water. The mix is 1 to 1.5% of the cement weight, i.e. about 1-1.5 litres of product for 100 kg of cement.

*Sikalatex*

This product dramatically improves the adhesion of mortar or concrete to all surfaces, even smooth ones (for example, joints between two pours of concrete), limits the risk of cracks, and ensures high impermeability (in the case of water-tank coatings for example). It is a milky liquid, and comes in concentrated form in 2-litre cans or 30-litre drums.

Sikalatex mortar is a bonding mortar which provides a rough surface, either for repairing concrete, or for a waterproof coat. The standard mix is approximately 0.12 l per m<sup>2</sup> of bonding layer.

### 1.4 Steel for reinforced concrete

Reinforced concrete benefits from the combination of the properties of its two materials: the compressive resistance of concrete, and the tensile resistance of the steel incorporated in the concrete structure (Table X).

**Table X: Resistances of steel and concrete.**

	Tensile resistance (kg/cm <sup>2</sup> )	Compressive resistance (kg/cm <sup>2</sup> )
Concrete bar	30	300
Steel bar	3 000	3 000



### 1.4.1 PROPERTIES OF REINFORCEMENT STEELS

The steel used for reinforced concrete is high-adhesion steel, known as HA, which has serrations in order to ensure better adhesion with the concrete.

Smooth reinforcement bars are increasingly falling out of use, and they require particular structural arrangements (greater anchorage lengths).

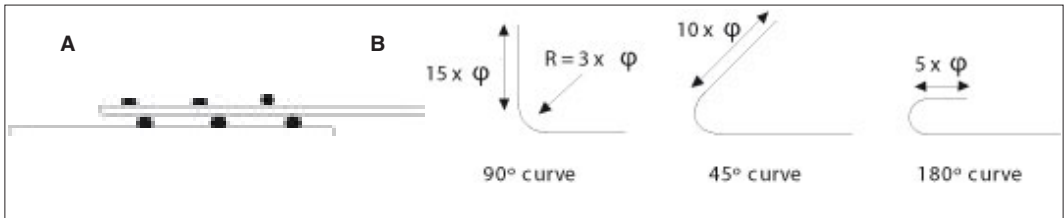
The correspondence between international and UK/US diameters of bars used for reinforcement are given in Table XI.

**Table XI: Correspondence of diameters between international and UK/US units.**

Diameter in mm	Diameter in inches
6	1/4"
8	1/3"
12	1/2"
16	2/3"
25	1"

### 1.4.2 PLACING, ANCHORAGE, OVERLAPS

Some typical reinforcement arrangements for various types of structural element are illustrated in Figures 4 and 5, and in Box 4.



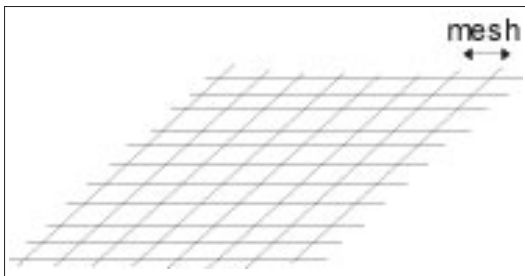
**Figure 4: Arrangement of reinforcement bars.**

**A: welded mesh (overlapped). B: curved bar anchoring lengths.**

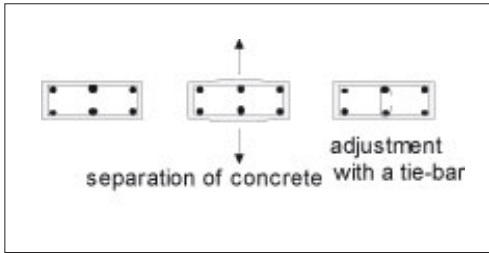
#### Box 4

##### Welded mesh.

Welded mesh (Figure 1) is used for reinforcing slabs and partitions. It replaces standard steel reinforcement bar tied with annealed steel wire, and is easier to use. As with standard reinforcement, welded mesh is characterised by the bar diameter and the mesh size. When placing welded mesh, there should be an overlap of 3 welds in the direction of the main bars.



**Figure 1: Welded mesh used for the reinforcement of slabs or tank sides.**



**Figure 5: Reinforcement for a pillar.**

The transmission of stresses from concrete to steel and vice versa occurs through adhesion. To ensure proper adhesion, it is necessary to have clean surfaces (free from organic matter, oil, rust etc.), to maintain a sufficient length of steel anchorage (Table XII), and to vibrate the concrete correctly. The reinforcement must be covered by at least 3 cm of concrete.

**Table XII: Anchorage lengths.**

Reinforcement	High adherence	Smooth
Curved	30 diameters	40 diameters
Straight	50 diameters	60 diameters

## 2 Rapid structural calculations

### 2.1 Load calculations

To design structures, the loads which they experience (Table XIII) must be calculated. There are two types of load:

- static loads due to the weight of structures (permanent loads);
- dynamic loads due for example to the weight of the water in a tank, or the weight of materials stored on a slab.

**Table XIII: Dynamic loads on structures.**

Dynamic load for slabs	
Private premises	200 kg/m <sup>2</sup>
Public place	500 kg/m <sup>2</sup>

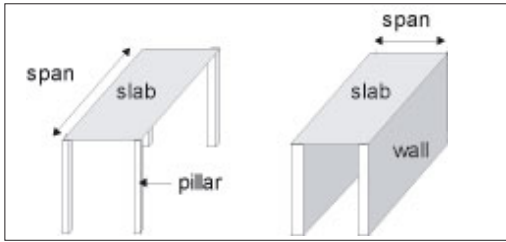
Static loads are added to dynamic loads in many calculations; foundations, for example, experience the static loads of the building, plus the dynamic loads. To calculate static and dynamic loads, see Table XXIX.

### 2.2 Reinforced-concrete elements

The tables in this section provide indications for choosing dimensions and reinforcement arrangements standard structures. In each table, figures in *italics* are optimal from the structural and cost points of view.

#### 2.2.1 DEFINITIONS

Slab: this term is used for suspended slabs (floors), cover slabs (on water tanks), and small structures (e.g. slabs for tapstands and washing areas).



**Figure 6: Span of a slab.**

Base: the base is a slab on the ground serving as a foundation.

Span (of a slab or beam): the length between the supports on which the beam or slab rests (Figure 6). In the case of a slab supported by four walls, the span considered is the distance between the walls closest to one another. In the case of a slab supported by four pillars, the largest distance between supports is considered the design span.

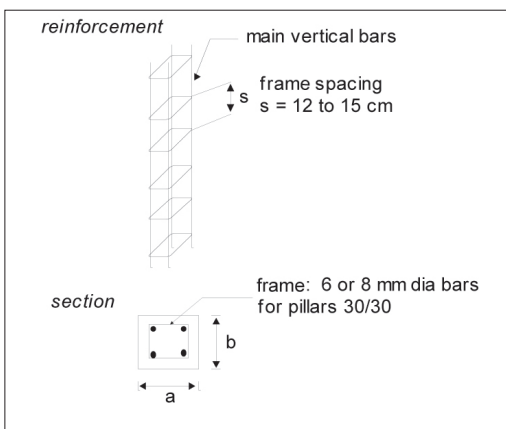
Mesh: the spacing between the bars in a reinforcement layout. If the spacing between the transversal and longitudinal (or horizontal and vertical) bars is the same, the mesh is called square.

### 2.2.2 PILLARS

Sizing: the minimum cross section is equal to 1/20th of the pillar height. Pillars can support heavy loads, e.g. in the case of an elevated water tank. The reinforcement arrangements are shown in Figure 7, and the reinforcement sizing in Table XIV.

**Table XIV: Reinforcement design, and permissible dynamic loads on a pillar as a function of its height. For a & b, see Figure 7.**

Section (a x b, cm x cm)	Main vertical bars		Dynamic load (t) depending on height (m)					
	number	diameter (mm)	2.5	3.0	3.5	4.0	5.0	6.0
15x15	4	10	15.5	12.5	11.0	9.5		
	4	12	16.5	13.5	11.5	10.5		
	4	16	20.0	16.5	14	12.5		
15x20	4	14	21.0	18.5	16.5	13.5		
20x20	4	14			26.0	23.5	19.5	
25x25	4	14			49.5	42.5	35.5	
25x30	6	14			61.5	52.5	50.5	
30x30	4	16				70.5	53.0	48.0



**Figure 7: Reinforcement for a pillar.**

### 2.2.3 BEAMS

Sizing: the section of the beam is equal to 0.3 times its height, which lies between 1/10th and 1/15th of its span. The reinforcement arrangements are shown in Figure 8 and Table XV.

**Table XV: Reinforcement design, and acceptable dynamic load on a beam, depending on its span.**

Section (a x b, cm x cm)	Main reinforcement		Dynamic load (t/m) depending on the span (m)								
	number	diameter (mm)	1.5	2.0	2.5	3.0	3.5	4.0	5.0	6.0	7.0
10x15	2	8	0.5								
10x20	2	10	1.0	0.5							
15x25	2	12	4.0	2.2	1.4	1.0	0.5				
15x30	2	12		2.8	1.75	1.2	1.0	0.5			
15x40	2	14			2.25	1.65	1.25	0.5			
20x30	3	12				1.8	1.3	1.0	0.5		
20x40	3	16						2.5	2.0	1.6	1.3
20x50	4	16							2.5	1.9	1.3
25x55	4	16								2.1	1.5



**Figure 8: Reinforcement mesh (A) and normal dimensions (B) for a beam.**

In A, frame spacing is close over the supports, and increases towards the mid-point of the beam, where  $s$  varies as a function of load and the dimensions of the beam (dynamic load 4 t,  $s = 8$  cm; 2 – 3 t,  $s = 12$  cm; 1 t,  $s = 15 - 20$  cm).

The greater the ratio between beam height and width ( $b:a$ ), the greater the value of  $s$ .

For thick beams (55x25) supporting loads of 1 – 2 t,  $s = 40$  cm.

Nominal loads on relatively unstressed beams are 500 to 1 000 kg per m length.

### 2.2.4 SLABS

Sizing: minimum slab thickness 7 cm:

– slab on 2 walls:

$s = 1/20$ th to  $1/30$ th of the span

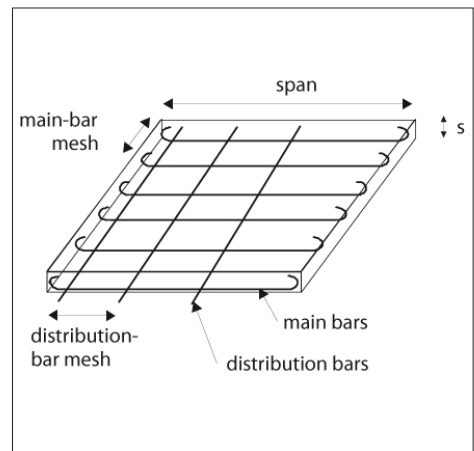
– slab on 4 supports:

$s = 1/20$ th of the span

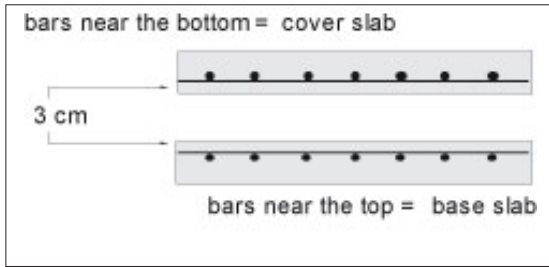
– slab on 4 walls:

$s = 1/30$ th to  $1/40$ th of the span

The usual reinforcement plan for a slab is shown in Figure 9. The main bars are located towards the bottom of the slab (Figure 10), except in a base, where they are towards the top of the slab.



**Figure 9: Reinforcement for a slab.**



**Figure 10: Location of main reinforcement bars according to type of slab (base or cover).**

**2.2.4.1 Rectangular slab on free supports (2 walls)**

The main bars to be used for a slab on two walls, depending on the span, for a uniformly distributed load, are indicated in Table XVI.

Regarding distribution bars, diameters of 6 or 8 mm are used. The mesh is 20 cm for  $L < 4$  m in 6-mm bar, and 15 cm for  $L > 4$  m in 8-mm bar.

**Table XVI: Main bar sizes, and acceptable dynamic load, depending on the thickness of the slab and its span.**

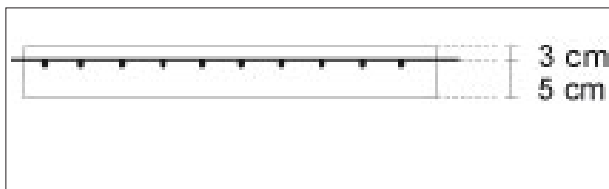
Thickness (cm)	Reinforcements		Dynamic load (kg/m <sup>2</sup> ) depending on the span (m)							
	diameter (mm)	mesh (cm)	1.5	2.0	2.5	3	4	5	6	
7	8	14	500	250						
9	8	10	1 300	600	300	150				
12	10	11		1 500	800	450	150			
15	12	12			1 500	950	375	110		
19	12	9				1 700	800	350	100	
24	16	13					1 800	900	450	
30	16	10							1 200	650

**2.2.4.2 Base (ground slab)**

Generally this type of structure does not experience heavy stresses (see Table XIII) and the ground pressure provides support. A reinforcement of the same diameter for longitudinal and transverse bars, with a square mesh (Figure 11 & Table XVII), is used.

**Table XVII: Mesh sizes for a base (ground slab) depending on the diameter of the bars used.**

Diameter (mm)	Mesh (cm)
6	15
8	30
10	40



**Figure 11: Layout of reinforcement for base slab.**

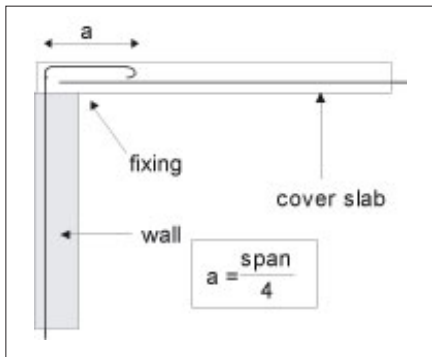
### 2.2.4.3 Cover slab for water tank

Generally this type of slab is not subject to heavy dynamic loads. Therefore, a minimum thickness of 8 cm can be used. The reinforcement for a circular water-tank cover slab is shown in Table XVIII.

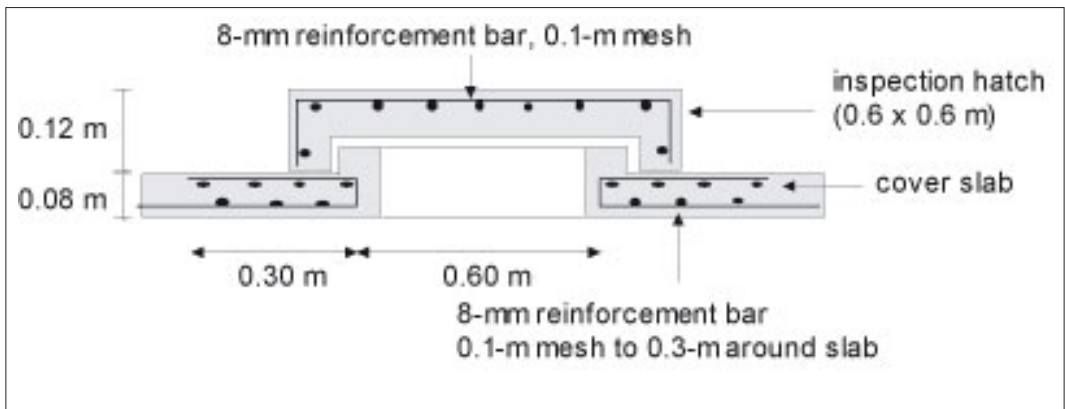
**Table XVIII: Reinforcement for a circular water-tank cover slab.**

Internal diameter of the tank (m)	Diameter of bar (mm)	Mesh (cm)
2	6	25
3	6	17
4	8	17
5	8	10
6	10	11

Semi-fixed slabs are better able to withstand stresses; reinforcement rules to be observed are illustrated in Figures 12 and 13.



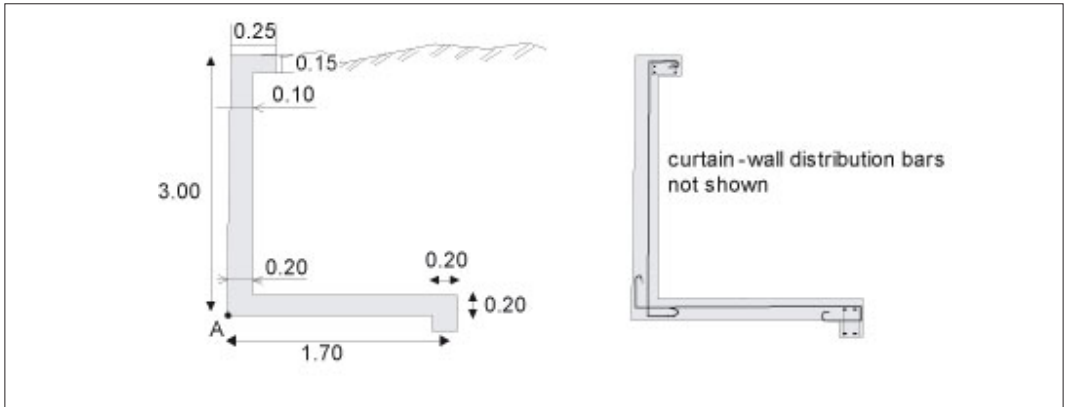
**Figure 12: Reinforcement for a semi-fixed slab.**



**Figure 13: Dimensions and reinforcement for a water-tank cover inspection hatch.**

### 2.2.5 RETAINING WALLS

Figure 14 and Table XIX give the dimensions and reinforcement for a reinforced-concrete retaining wall 3 m high, supporting earth (clay soil, pebbles and gravels, top soil, sandy soil).



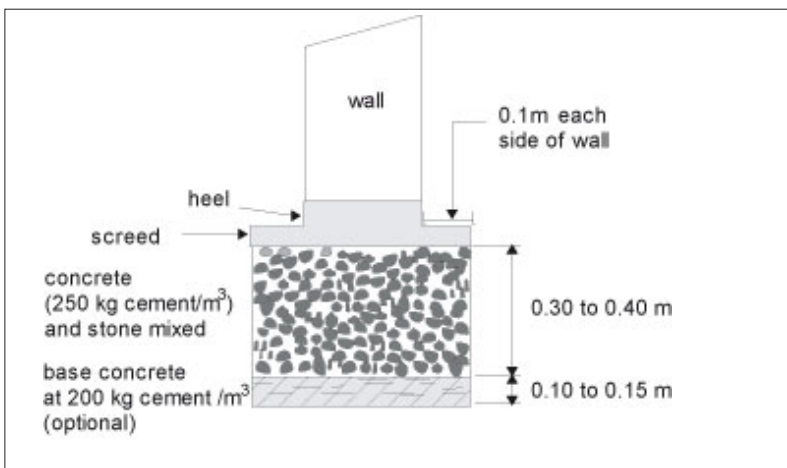
**Figure 14: Dimensions and arrangement of reinforcement of a reinforced-concrete retaining wall 3 m high.**

**Table XIX: Reinforcement dimensions for a reinforced-concrete retaining wall 3 m high.**

Reinforcement bars of the curtain wall	10-mm bar / mesh 11.5 cm Every second bar is stopped at mid-height
Distribution reinforcement bars	8-mm bar / mesh 20 cm for lower part 6-mm bar / mesh 20 cm for upper part
Base reinforcement bars (footing)	Same reinforcement as for curtain wall 10-mm bar / mesh 11.5 cm      main bars 8-mm bar / mesh 20 cm          distribution bars

## 2.2.6 FOUNDATIONS

Generally, foundations are 30 cm deep, in concrete mixed at 350 kg cement/m<sup>3</sup> in which large stones are placed (Figures 15 to 17). This concrete is commonly used in foundations because it requires a relatively small volume of concrete and is therefore less expensive. A finishing screed of concrete evens out differences in level due to large stones and at the same time provides a flat surface for erecting walls or pouring concrete for a tank wall.



**Figure 15: Section through a foundation.**

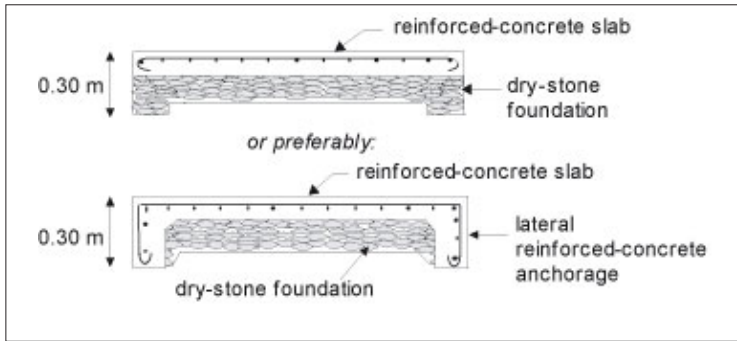


Figure 16: Foundation under slab.

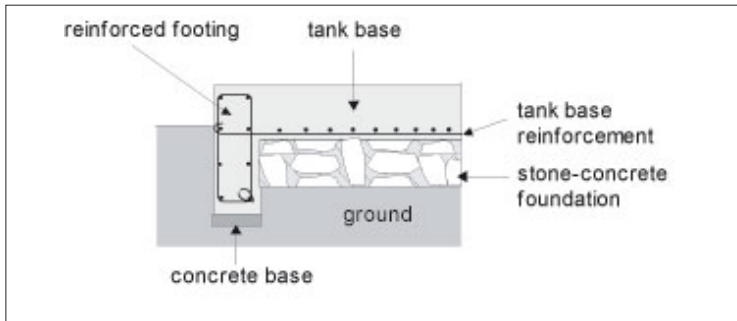


Figure 17: Example of foundation for a medium-sized water tank. Total height of footing is 40 cm (including slab thickness); width of footing is 15 cm.

The best tank shape is circular (Table XX); rectangular tanks have a great number of disadvantages.

Table XX: Examples of the capacity of standard circular water tanks.

Height (m)	1	1.45	1.7	2.65	3.25
Diameter (m)	1.75	2.25	2.75	4.75	6
Capacity (m <sup>3</sup> )	2	5	10	45	90

## 2.2.7 WATER TANKS

### 2.2.7.1 Circular water tanks

Horizontal reinforcement (in circles) is essential to withstand the stress on the circumference of a circular tank (Table XXI to XXIII). At the top of the tank, the force is very weak, and reinforcement is hardly necessary; however, the space between the circular reinforcement bars should not be more than three times the thickness of the tank wall.

Table XXI: Horizontal reinforcement, in 1-m sections starting from the top. Preferred sizes are shown in *italics*.

Wall thickness (cm)	10	10	10	10	10
Diameter (m)	1.5 to 2	2 to 2.5	2.5 to 3	4.5 to 5	6
Height (m)	Diameter of the bars (mm) and mesh (cm) used				
0-1	8 / 25	8 / 25	8 / 25	8 / 25	8 / 25
1-2	<i>8 / 25</i>	<i>8 / 25</i>	<i>8 / 25</i>	8 / 15	10 / 17.5
2-3		8 / 15	8 / 15	10 / 12.5	12 / 15
3-4			10 / 15	12 / 12.5	12 / 10



**Table XXII: Vertical reinforcement (distribution bars).**  
**In practice, it is sufficient to stop every second bar at mid-height.**

Diameter (mm) and mesh (cm) of bars used	
Bottom of tank up to mid-height	8 / 10
Mid-height up to top of tank	8 / 20

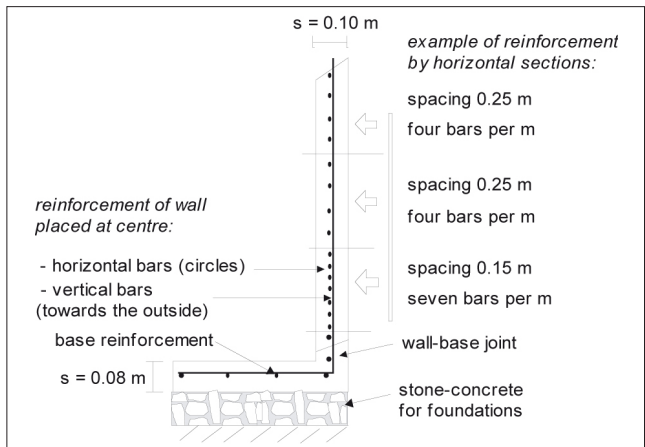
**Table XXIII: Base reinforcement.**

Diameter of the bars used (mm)	Mesh size
6	15 cm – square mesh
8	30 cm – square mesh

An example of reinforcement of a circular tank is shown in Figure 18. The spacing of the horizontal bars increases the nearer they are to the top of the tank, moving away from the heavily-stressed area:

- the procedure is to divide the tank into 1-m sections;
- the spacing is increased to a maximum of three times the thickness of the wall above it.

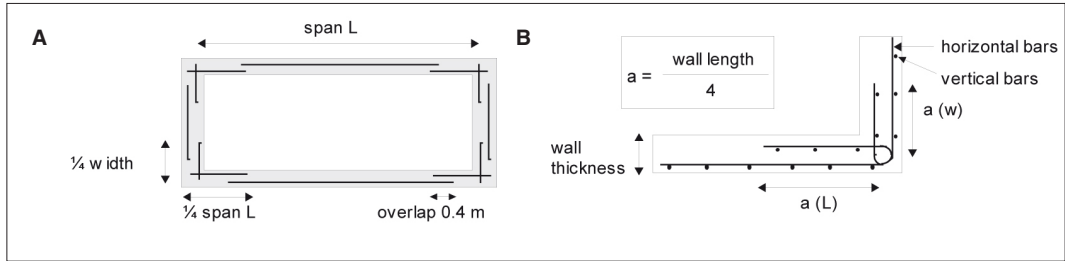
This configuration is generally modified for large-capacity tanks.



**Figure 18: Example of reinforcement for a circular tank.**

**2.2.7.2 Rectangular tanks**

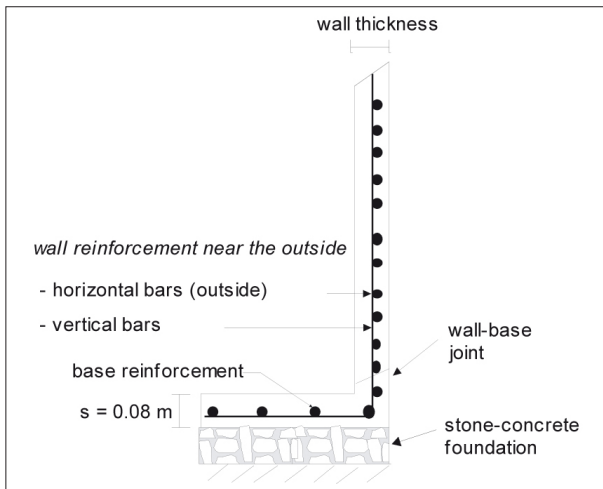
The configuration of an example of reinforcement for a rectangular tank is shown in Table XXIV and Figs 19 to 21.



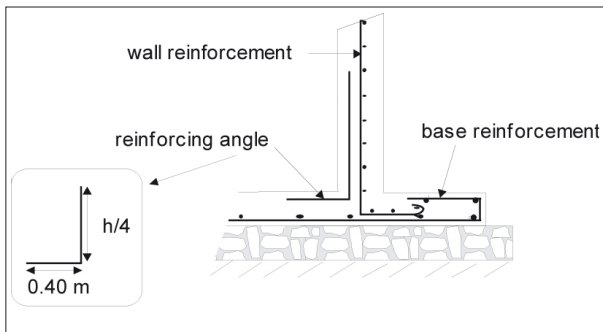
**Figure 19: Reinforcement for a rectangular tank.**  
**A: horizontal section through wall reinforcement. B: vertical section through wall and base reinforcement.**

**Table XXIV: Dimensions and reinforcement of a rectangular water tank.**

Capacity (m <sup>3</sup> )	3	5	10	20	45	70
Height (m)	1.5	2	2	2.5	3	3
Width/length (m)	1.5 / 1.5	2 / 2	2 / 3	2 / 4	4 / 4	4 / 6
Partition-wall thickness (cm)	10	10	11	11	14	14
Vertical-wall reinforcement						
diameter (mm) / mesh (cm)	12 / 15	12 / 10	12 / 10	16 / 12	16 / 9	16 / 9
Horizontal-wall reinforcement						
diameter (mm) / mesh (cm)	8 / 17	8 / 13	8 / 13	12 / 19	12 / 15	12 / 15
Base reinforcement						
diameter (mm) / mesh (cm)	6 / 15	6 / 15	6 / 15	6 / 15	6 / 15	6 / 15
optional	8 / 30	8 / 30	8 / 30	8 / 30	8 / 30	8 / 30



**Figure 20: Wall reinforcement for a small rectangular tank: wall length less than 2 m, with overlap ('a' in Figure 19) 40 cm minimum.**



**Figure 21: Wall reinforcement for a high-capacity rectangular tank.**

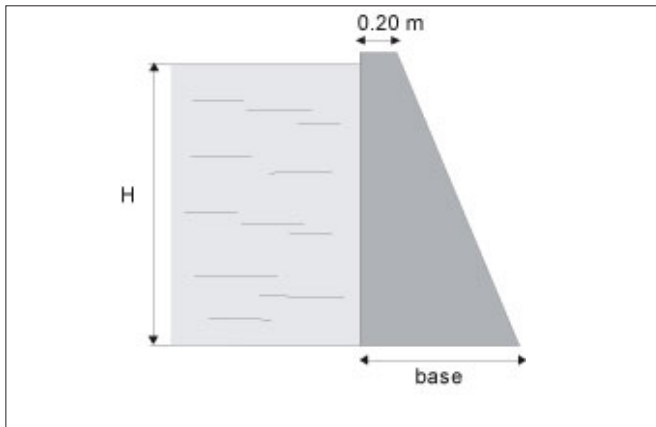
### 2.3 Standard jobs in masonry

It is possible to build retaining walls and small tanks in masonry provided that sufficient stone and enough workers are available.

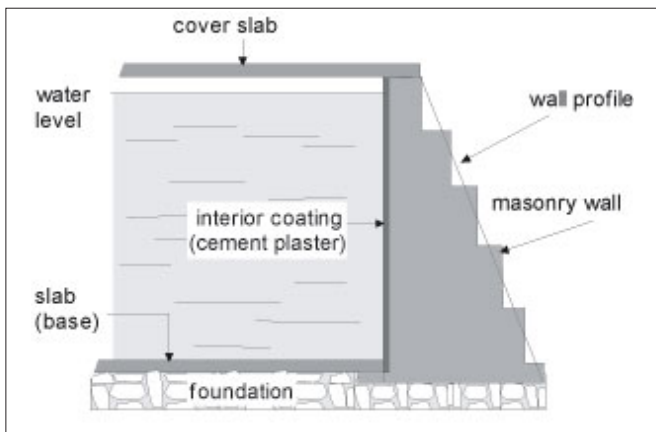
As the strength of the structure depends on the weight of the masonry resisting the thrust of the water, it is usually necessary to build walls very thick at the base. Table XXV indicates adequate dimensions for an earth-retaining wall (Figure 22), and of a water-retaining wall (tank or dam – Figure 23), calculated to avoid overturning (see Section 3.2.3.7). These calculations correspond to retaining firm earth without dynamic loads.

**Table XXV: Dimensions of a masonry retaining wall, and dam wall or tank wall, depending on the thickness at the base, for a thickness of 20 cm at the top.**

Retaining wall		Dam wall or tank wall	
Height of the wall (m)	Thickness at the base (m)	Height of water (m)	Thickness at the base (m)
1.0	0.40	1.0	0.65
1.5	0.65	1.5	1.00
2.0	0.85	2.0	1.35
2.5	1.10	2.5	1.72
3.0	1.35	3.0	2.10
3.5	1.60	3.5	2.50
4.0	1.80	4.0	2.80



**Figure 22: Retaining wall.**



**Figure 23: Tank side wall.**

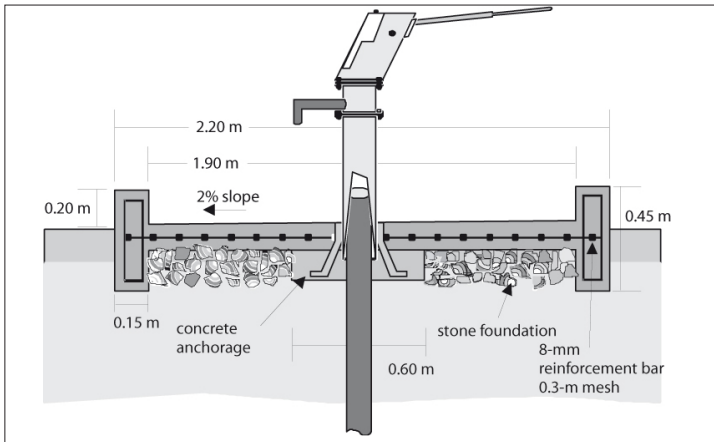
It is important not to forget to install weep-holes through earth-retaining walls to let out infiltration water, otherwise the thrust of the soil added to that of the water may cause the wall to collapse.

## 2.4 Water-point surface works

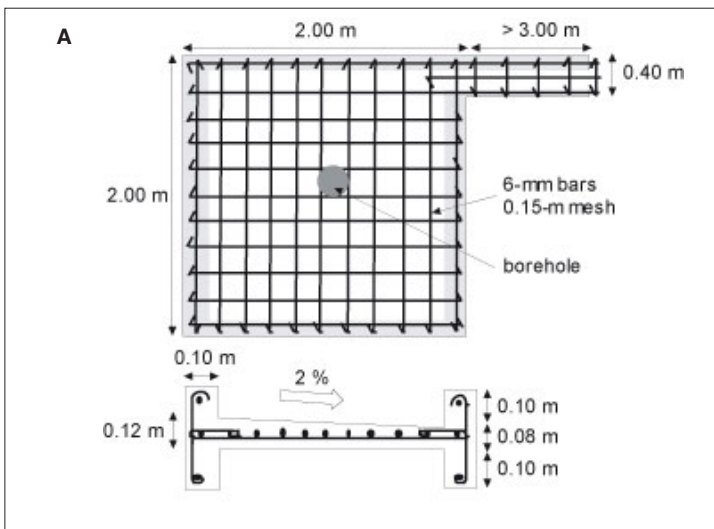
The surface works of water points can be built in masonry or reinforced concrete. The plans for the different parts and the main building arrangements are shown in Figures 24 to 26 (surface works of a borehole), 27 to 28 (surface works of a well) and 29 to 30 (tapstand and apron).



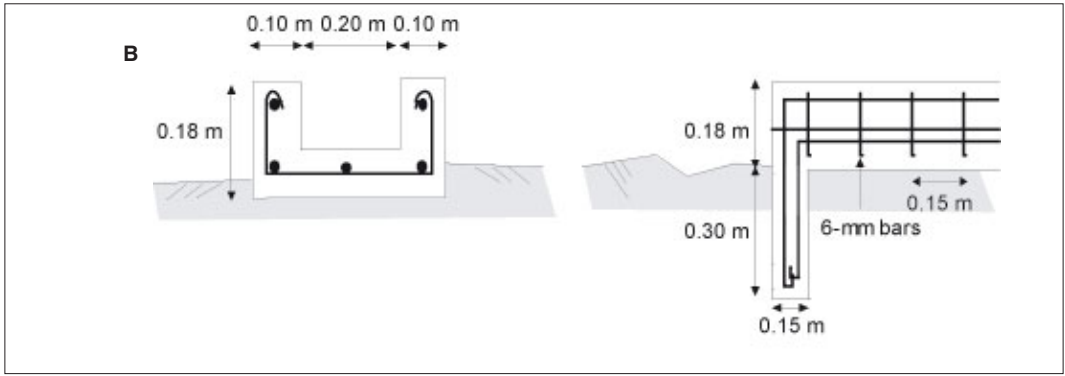
**Figure 24: Important features of surface works for a borehole.**



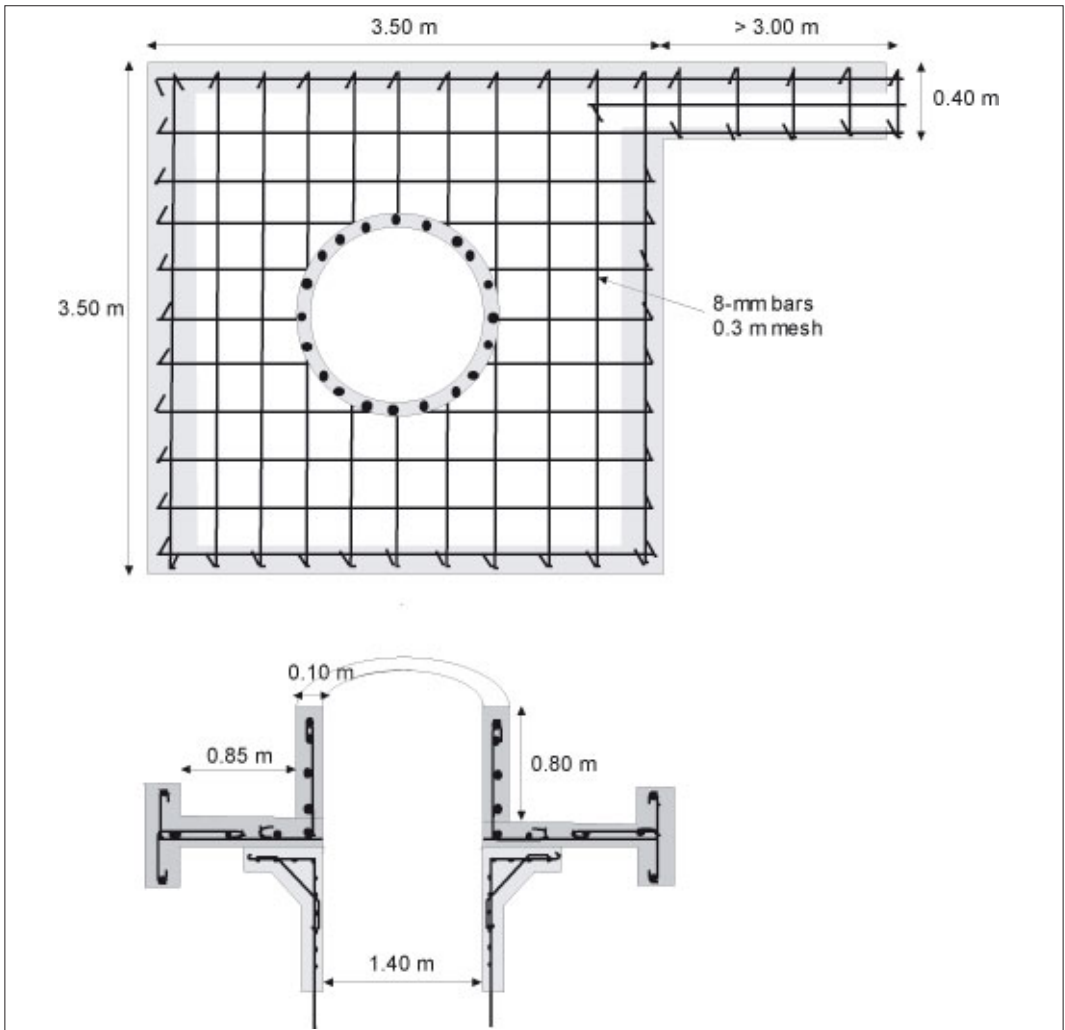
**Figure 25: Construction details for typical surface works for a borehole.**



**Figure 26: Reinforcement. A: slab.**



**Figure 26: Reinforcement.**  
**B: drainage channel.**



**Figure 27: Plan and section of surface works for a well.**

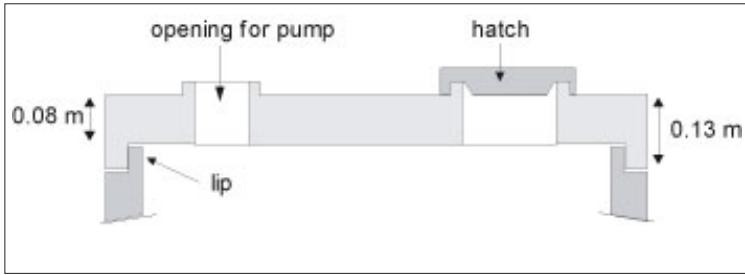


Figure 28: Well cover and inspection hatch.

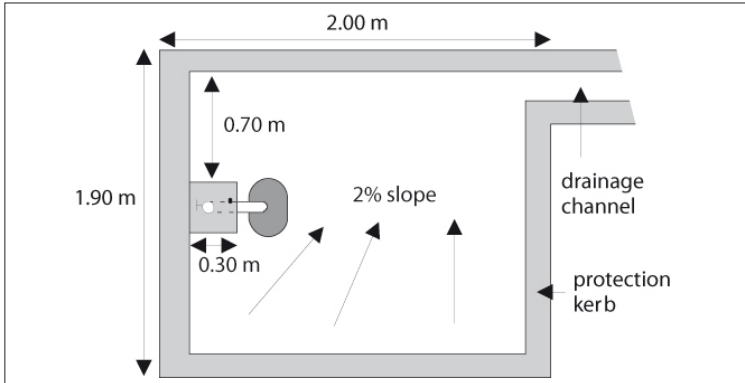


Figure 29: General plan of tapstand and apron.

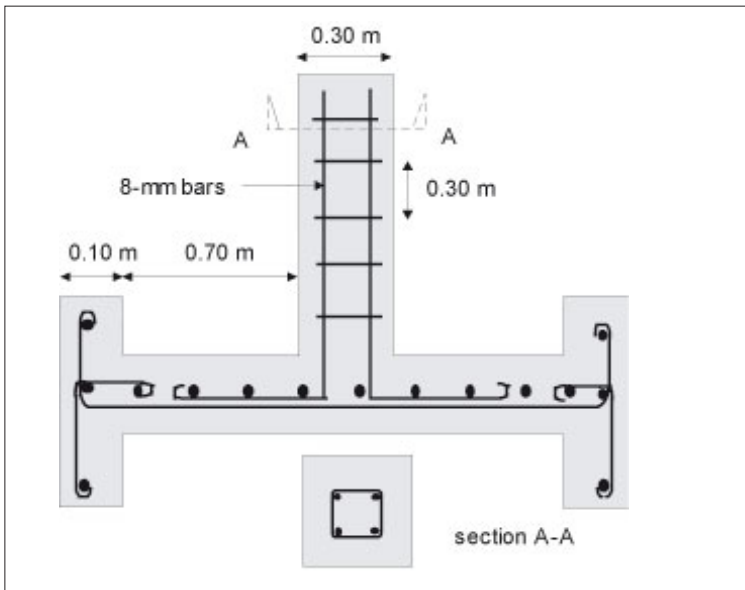


Figure 30: Reinforcement for tapstand and apron.

### 3 Further information

#### 3.1 Stresses in structures and type of reinforcement

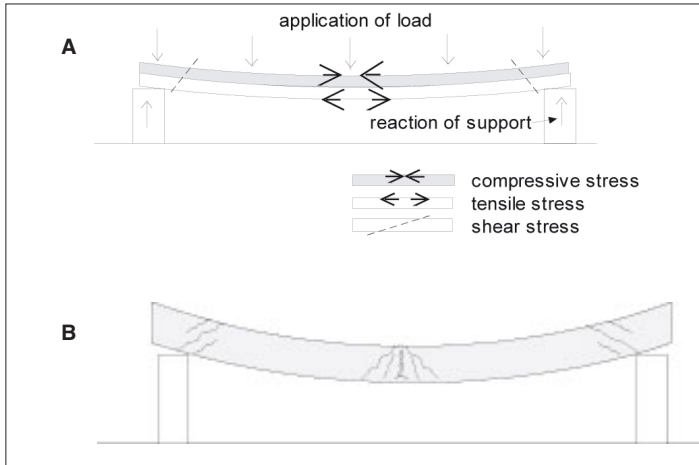
To make proper use of reinforced concrete, it is essential to carry out a precise determination of the loads borne by structures, and how they affect the positioning of reinforcement bars. Two simple examples are given here to facilitate rapid understanding of the procedures to be adopted.

### 3.1.1 BEAMS AND SLABS ON FREE SUPPORTS

A uniformly-distributed load is applied on the beam (its own weight, to which the dynamic loads to be supported are added – Figure 31A). The beam is distorted under the load, and the following can be observed:

- compressive stress: the load creates a distortion which tends to compress the concrete;
- tensile stress: an area in tension, generally symmetrical in relation to the compression area, appears under the load;
- shear stress (the reaction of the supports causes a force opposing the applied force, which tends to shear the beam).

Without reinforcement, fractures occur due to the tensile and shear stresses (Figure 31B).

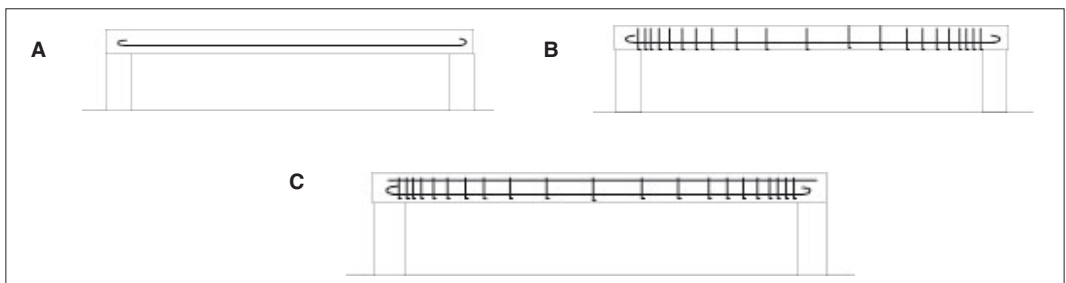


**Figure 31: Unreinforced beam on two simple supports under a uniformly-distributed load. A: stresses. B: cracking and fracture under the effect of loading.**

#### 3.1.1.1 Positioning of the reinforcement depending on the stresses

Specific reinforcement elements are used, depending on the stresses:

- the main bars (Figure 32A) are placed in areas under tension (tensile stress);
  - frames and stirrups (Figure 32B) are placed in areas where shearing occurs, i.e. mainly next to supports (the support reaction causes shear stress). Frames are then spaced progressively wider towards the mid-point of the beam (where shear stress is zero);
- the distribution and/or installation bars (Figure 32C) facilitate the assembly of the main bars with frames, and distribute the stresses.

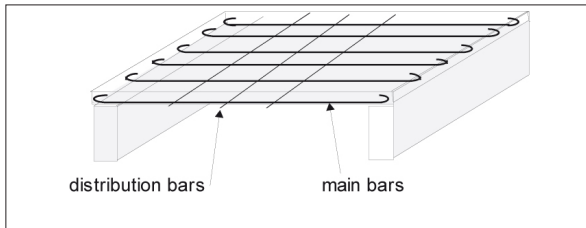


**Figure 32: Reinforcement of a beam on free supports.**

**A: location of main bars in the lower part of the beam (tensile area). B: location of frames close together near the supports and gradually more spaced out towards the mid-point of the beam. C: location of installation bars to permit assembly of frames and main bars.**

### 3.1.1.2 Extension to the case of a full slab supported by 2 walls (cover)

From a mechanical point of view, a slab is similar to a set of beams attached to one another, supporting a uniformly distributed load. Shear stresses are much lower than in a beam (geometric effect), and frames are not necessary. However, distribution bars, placed perpendicular to the main bars (tied with steel wire), are necessary to distribute the load over the whole surface of the slab, to avoid large cracks (Figure 33).

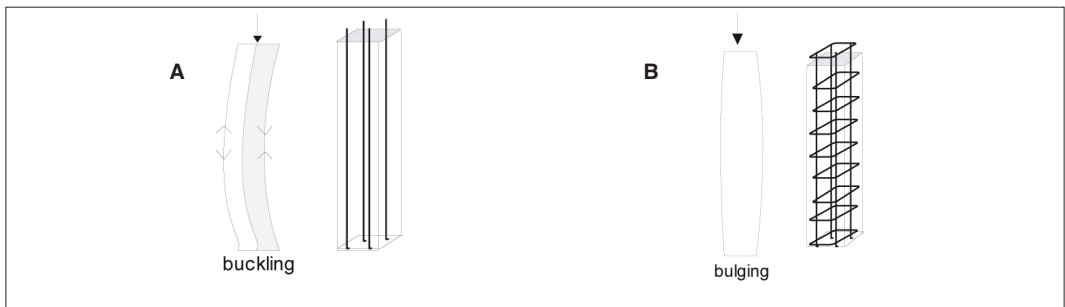


**Figure 33: Reinforcement of a full slab supported on two walls.**

### 3.1.2 PILLARS AND WALLS

These elements are subject to vertical forces which result in compressive stresses. However, if these elements are very high, other stresses can act in all directions. Reinforcement is then used (Figure 34) to reabsorb all these stresses (to avoid buckling and bulging of the pillar due to the application of a large load).

The buckling height determines the reinforcement required in a pillar. If the slenderness (real height of the pillar in relation to the shortest side) is less than 15, then the pillar is considered to act only in compression, and there is no risk of buckling.



**Figure 34: Reinforcement of a pillar to reabsorb all the stresses acting on the structure..**

**A:** to avoid buckling, which deforms the pillar and leads to tensile strain, longitudinal reinforcement is used. **B:** bulging of a section is restricted by the placing of transverse frames, which also facilitate the location of longitudinal bars.

## 3.2 Calculation of structures and common jobs in reinforced concrete

### 3.2.1 INTRODUCTION AND METHODOLOGY

The following methodology is used to calculate common concrete structures:

- choice of assumed stresses ( $\tau$ ) on the materials (concrete and steel);
- sizing of the reinforced-concrete element: beam height/width, pillar section, slab thickness and span;
- identification of forces: structural weight, water pressure in a tank, thrust of the soil (and water) on a retaining wall, weight of a vehicle on a culvert;



**Box 5**

Table for selection of reinforcement bars.

In practice, the calculations for reinforced-concrete structures give sections of bars which depend on the stresses experienced by one element (beam, slab, pillar etc.).

Table I determines the diameter and the number of steel bars per metre, depending on the calculated bar section.

**Table I: Characteristics of steel reinforcements.**

Diameter (mm)	Weight (kg/m)	Section of 1 bar (cm <sup>2</sup> )	Mesh (cm) / number of bars per m									
			50 2/m	35 3/m	25 4/m	20 5/m	17 6/m	15 7/m	12.5 8/m	11 9/m	10 10/m	
5	0.15	0.2	0.39	0.59	0.79	0.98	1.18	1.37	1.57	1.77	1.96	
6	0.21	0.28	0.57	0.85	1.13	1.41	1.7	1.98	2.26	2.54	2.83	
8	0.38	0.5	1.01	1.51	2.01	2.51	3.02	3.52	4.02	<b>4.52</b>	5.03	
10	0.59	0.79	1.57	2.36	3.14	3.93	4.71	5.5	6.28	<u>7.07</u>	7.85	
12	0.85	1.13	2.26	3.39	<b>4.52</b>	5.65	<u>6.79</u>	7.92	9.05	10.18	11.31	
14	1.16	1.54	3.08	4.62	6.16	<u>7.7</u>	9.24	10.78	12.32	13.85	15.39	
16	1.51	2.01	4.02	6.03	8.04	10.05	12.06	14.07	16.08	18.1	20.11	
20	2.36	3.14	6.28	9.42	12.57	15.71	18.85	21.99	25.13	28.27	31.42	
25	3.68	4.91	9.82	14.73	19.64	24.54	29.45	34.36	39.27	44.18	49.09	
32	6.03	8.04	16.08	24.13	32.17	40.21	48.25	56.3	64.34	72.38	80.42	
40	9.43	12.57	25.13	37.7	50.27	62.83	75.4	87.96	100.5	113.1	125.6	

*Example of use of the table*

- In bold: 12-mm bars at 25-cm centres (= 5 bars per m) must be used; the corresponding section is 4.52 cm<sup>2</sup>. If only 8-mm bars are available, it is necessary to use 9 bars per m (11-cm centres).
- Underlined: the calculation of a structure in reinforced concrete gives a bar section of 6.5 cm<sup>2</sup>. The reinforcement of the structure (slab) will be therefore be 5 bars per metre of 14 mm, or 6 bars of 12 mm, or 9 bars of 10 mm, depending on availability.

- identification of stresses acting on these elements: simple compression, shearing (reaction of the supports on which the structure rests), bending (tension and compression in the structure), peripheral forces (circular tanks);
- calculation of reinforcement-bar sections and spacing required to withstand these stresses (Box 5). The following simplified method is proposed: only the section of the main bars is calculated; then a ratio in relation to this is applied to obtain the section of distribution bars to be used.

### 3.2.2 EXAMPLES OF APPLICATION

#### 3.2.2.1 Assumed stress limits for materials

The assumed stress limits for concrete and steel are shown in Tables XXVI and XXVII.

**Table XXVI: Stress limits for concretes which are not of high quality (aggregate size and quantities of water and cement are not carefully controlled).**

Concrete mix (kg of cement/m <sup>3</sup> )	Stress (kg/cm <sup>2</sup> )
250	46
300	58.5
350	68.5
400	76.5

**Table XXVII: Stress limits for steels.**

For water-supply applications, HA bars with a resistance of 1 650 kg/cm<sup>2</sup> are recommended, to avoid any cracks which could be particularly damaging to the waterproofing of the material (corrosion of these steels). The elastic limit is the stress above which the bar material does not return to its initial state after being stressed.

	Elastic limit (kg/cm <sup>2</sup> )	Stress limit (kg/cm <sup>2</sup> )
Smooth bars	2200-3400	1470-2270
High adhesion bars (HA)	4200-5000	2700-3300

### 3.2.2.2 Sizing of concrete sections

The geometrical characteristics of the structure allow empirical determination of its concrete section (Table XXVIII), except for rectangular tanks (see Section 2).

**Table XXVIII: Rapid calculation of concrete sections for common structures.**

Type of structure	Parameter to be sized	Parameter sizing (cm)
Square section pillar	Height (minimum 15 cm)	1/14.4 buckling height of the pillar ( $h_{\text{buckling}} = 0.7 h_{\text{real}}$ )
Beam	Height (minimum 15 cm) Width (minimum 10 cm)	1/10th to 1/15th span of the beam Width = 0.3 height
Slab on 4 supports	Thickness	1/20th span
Slab on 2 walls	(minimum 8 cm)	1/30th span
Slab on 4 walls		1/40th span
Wall of a circular tank	Thickness (minimum 8 cm)	$s = 0.22 \times D \times H$
Wall of a rectangular tank	Thickness (minimum 8 cm)	See Section 2.2.7.2

### 3.2.2.3 Forces applied to structures and resulting stresses (moments)

There are two types of loading, static loads G (weight of structure, water in a tank), and dynamic loads P (Table XXIX). Total stress S is therefore:

$$S = G + 1.2 P$$

For water-supply structures (subject to water pressure) such as tank walls and tank bottoms:

$$S = 1.2 G$$

**Table XXIX: Calculation of static and dynamic loads.**

<i>Permanent loads on structures</i>	
Stone masonry	2 500 kg/m <sup>3</sup>
Hollow load-bearing blocks	1 500 kg/m <sup>3</sup>
Concrete – reinforced concrete	2 400 - 2 500 kg/m <sup>3</sup>
Slab in reinforced concrete	25 kg/m <sup>2</sup> /cm of thickness
<i>Dynamic loads for slabs in use</i>	
Private premises	200 kg/m <sup>2</sup>
Structures open to the public	500 kg/m <sup>2</sup>

3.2.2.4 Stresses in structures, bending moments

The stresses experienced by structures when loads (or forces) are applied to them are characterised by moments. Calculation of moments depends on the loads supported (uniform or point loads, point and direction of application of the force), and the type of structure (whether or not fixed to other reinforced-concrete elements). Moments differ in all points of the structure. For example, the moment at the centre of a slab on free supports is maximum, whereas it at the supports is zero. It is the maximum moment that should be determined when designing a structure.

*Bending-moment diagrams*

The most common case is the simple bending moment, incorporating tension and compression. These bending stresses can be represented in diagrams that are useful for understanding stresses on structures and for locating reinforcement. Two examples of bending moment diagrams feature a beam (or slab) subject to a uniformly distributed load, and the walls of a rectangular tank subject to water pressure.

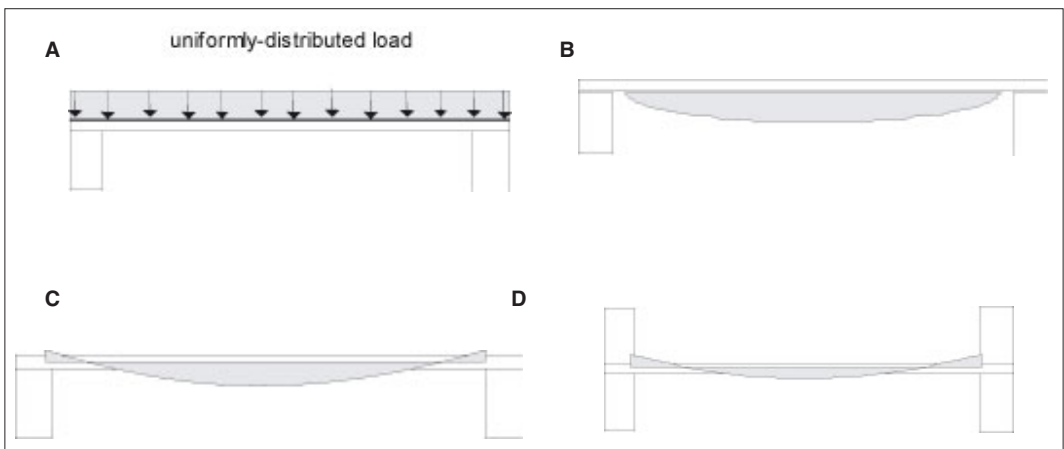
– *Beam or a slab*

Moments in three standard configurations – free, semi-fixed, and fixed supports – are shown in Figure 35. Stresses (and the calculation of moments, Table XXX) experienced by these three types of beam are different. The maximum bending moment is located at the centre of the beam.

**Table XXX: Calculation of maximum bending moment for a uniformly-distributed load in three standard configurations of beam.**

**P: weight of the load (kg). L: span of the beam (m). BM: bending moment (kg/m).**

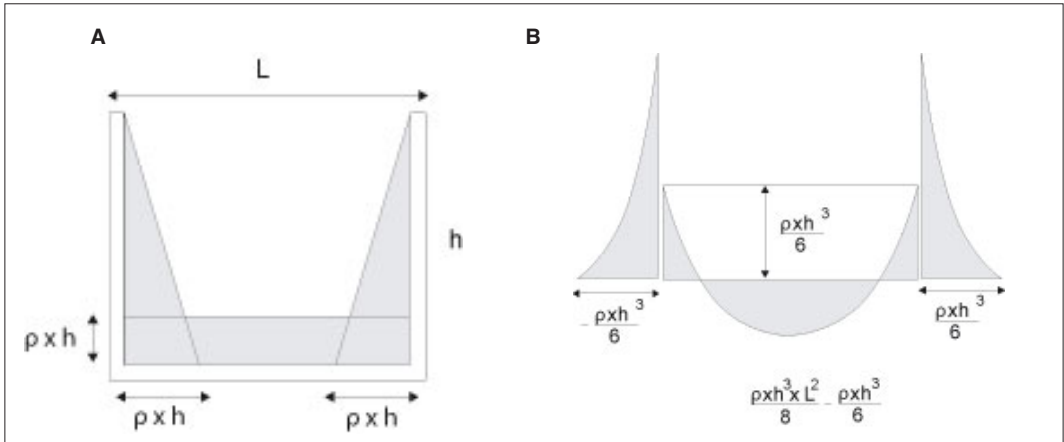
Beam on free supports	Maximum moment at the centre Next to the support	$BM = -P \times L^2/8$ $= 0$
Semi-fixed beam	Maximum moment at the centre Next to the support	$BM = -P \times L^2/10$ $= + P \times L^2/24$
Fixed beam	Maximum moment at the centre Next to the support	$BM = -P \times L^2/12$ $= + P \times L^2/12$



**Figure 35: Stresses in a beam.**

**A: uniformly-distributed load. B: moment on 2 supports. C: moments on 2 semi-fixed supports.**

**D: moments on 2 fixed supports.**



**Figure 36: Rectangular tank subject to water pressure.**  
**A:** diagram of forces (pressure) resulting from weight of water in the tank.  
**B:** bending moment diagram in a vertical section of the wall.  
**h:** depth of water (m).  $\rho$ : density ( $\text{kg/m}^3$ ).

Bending moments opposite to the direction of application of the load appear when the beam is semi-fixed or completely fixed. The tensile area then reduces considerably, down to almost 50% for a fixed beam. As far as possible, semi-fixed beams and slabs (with pillar reinforcement and beam reinforcement linked) are therefore preferred.

– *Elevated rectangular tank subject to water pressure*

A bending moment diagram for the walls of an elevated rectangular tank subject to water pressure is shown in Figure 36. The walls are fixed (linked to one another) and moments resulting from this linkage can be noted at the angles, which require reinforcements (see Section 2).

3.2.3 DESIGN CALCULATION EXAMPLES

3.2.3.1 Pillars

In the example of a pillar acting only in compression, i.e. without buckling, the non-buckling condition allows the determination of the section of the pillar as a function of its height.

*Dimensions*

$$a = \frac{l_f}{14.4}$$

where  $a$  is the smallest dimension and  $l_f$  the buckling length. This length depends on the actual length of the pillar  $l_0$  and the type of pillar (fixed or otherwise). Buckling length  $l_f$  is determined by:

$$l_f = 0.7 \times l_0$$

The concrete section of the pillar is therefore given by:

$$A_{\text{concrete}} = a^2$$

*Calculation of permissible load*

The pillar is not loaded above 50 kg/cm<sup>2</sup>, so that:

$$\text{permissible load (kg)} = 50 \times a^2$$

This calculation does not take account of the section of the pillar reinforcement bars. In the case of small pillars, for which the section ( $A_{steel}$ ) is significant relative to the concrete section ( $A_{concrete}$ , already defined), an equivalent section ( $A_{eq}$ ) can be calculated from:

$$A_{eq} = A_{concrete} + (15 \times A_{steel})$$

Thereby obtaining: permissible load (kg) =  $50 \times A_{eq}$

This calculation also helps verify the dimensions of a pillar and the non-buckling condition (Table XXXI).

**Table XXXI: Example of calculation of a pillar in reinforced concrete loaded to 50 kg/cm<sup>2</sup>.**

**CALCULATION**

*Data*

Actual pillar height required	4 m
Diameter of vertical reinforcement bars	12 mm

*Calculation of dimensions*

Buckling height	2.8 m
Dimension of smallest side	20 cm
Permissible total load on the pillar <sup>1</sup>	20 t
Permissible total load on the pillar <sup>2</sup>	24 t

**VERIFICATION OF A PILLAR ALREADY DESIGNED**

*Data*

Actual pillar height	4 m
Dimension of smallest side	15 cm
Diameter of vertical reinforcement bars	12 mm
Total load on the pillar	20 t

*Stress on pillar and buckling ratio<sup>3</sup>*

Stress in reinforced rate of pillar	69 kg/cm <sup>2</sup>
Buckling ratio	19

1. Calculation without taking account of reinforcement bars.
2. Calculation taking account of reinforcement bars in compression.
3. This example demonstrates that if the stress is greater than 50 kg/cm<sup>2</sup>, the pillar is under-sized. In the same way, if the buckling ratio is greater than 14.4, the stress must be much lower than 50 kg/cm<sup>2</sup>.

*Note.* – When designing a pillar, the reinforcement ( $A_{steel}$ ) is not calculated (the pillar is calculated in simple compression). On the other hand, the pillar is always reinforced (see Section 2) and  $A_{steel}$  is taken into account when the permissible load on the pillar is verified later.

**3.2.3.2 Slabs in simple flexion**

- Design of the concrete section (Section 2).
- Calculation of total weight per m<sup>2</sup> of slab (static + dynamic loading).
- Calculation of maximum moment in the slab (Table XXXII).
- Calculation of the reinforcement section in flexion by the approximate formula:

$$A_{steel} = \frac{M}{\tau_{steel} \times Z}$$

where M is the moment (kg.m),  $\tau$  the stress limit of the reinforcement bars (kg/cm<sup>2</sup>) and z the leverage in the structure (cm), calculated by:  $z = 7/8 \times t$ , where t is the thickness of the slab.

The calculations and design details are summarised in Table XXXIII.

**Table XXXII: Maximum moment in a slab.**

Type of slab	Maximum moment at centre
Rectangular slab on two free supports (2 walls)	$\frac{P \times L^2}{8}$
Semi-fixed rectangular slab (on 2 walls)	$\frac{P \times L^2}{10}$
Circular slab supported at its periphery	$\frac{P \times L^2}{20}$

**Table XXXIII: Calculations for the construction of a rectangular slab in flexion on two supports (walls).**

<b>DATA</b>	
<i>Geometric characteristics</i>	
Slab span	4 m
Type of slab <sup>1</sup>	Semi-fixed
Dynamic load	500 kg/m <sup>2</sup>
<i>Bars available in the field</i>	
Main-bar diameter	12 mm
Distribution-bar diameter	8 mm
<b>RESULTS OF CALCULATIONS</b>	
<i>Dimensions</i>	
Slab thickness <sup>2</sup>	14 cm
Total load <sup>3</sup>	850 kg/m <sup>2</sup>
Maximum moment in the slab	1 360 kg.m
<i>Wall reinforcement<sup>4</sup></i>	
Calculated section of main bars	9 cm <sup>2</sup>
Actual diameter of main bars	12 mm
Actual mesh of main bars	13 cm
Calculated section of distribution bars	3 cm <sup>2</sup>
Actual diameter of distribution bars	8 mm
Actual mesh of distribution bars	17 cm

1. The slab can be semi-fixed or on free supports and supported by 2 continuous walls, on pillars or on its four sides.
2. For a slab supported by 2 walls.
3. Total load = static load + dynamic load.
4. The reinforcement mesh must be between 10 and 30 cm: if more or less steel is required, it is necessary to change the diameter of bars used, rather than go outside these limits.

### 3.2.3.3 Economic design of reinforced-concrete tanks

The dimensions given in Table XXXIV do not apply to large-capacity tanks, because the height must be lower than 4 m. Octagonal or hexagonal tanks come closer to the most favourable shape, the circle.

**Table XXXIV: Optimum dimensions from an economic viewpoint for the construction of a tank in reinforced concrete.**

Cylindrical tank	Covered (slab)	Diameter = height
	Open	Diameter = 2 x height
Square-base tank	Covered	Side = height
	Open	Side = 1/2 height

### 3.2.3.4 Circular tank

In circular tanks, the force acting on the circumference is critical. It is therefore considered that the horizontal circular bars (these are the main bars), withstand the stress in the circumference while the vertical bars (known as distribution bars) resist the pressure on the walls.

The bars of the base resist the weight of the depth of water above them.

– Calculation of wall thickness ( $t$  - minimum 10 cm):

$$t = 0.22 \times D \times H$$

– Calculation of the horizontal-bar sections by horizontal sections through the tank every 1 m of height:

$$A_{\text{steel}} = \frac{P \times R}{\tau_{\text{steel}}}$$

where  $A$  is the bar section ( $\text{cm}^2$ ) per metre of height,  $H$  the water depth (m), and  $R$  the tank radius (m). The value of  $P$  is  $1\,200\,H$  ( $\text{kg/m}$ ), and  $\tau_{\text{steel}} = 1\,650$   $\text{kg/cm}^2$ .

Water density is taken as equal to 1.2 to take account of the effect of filling and emptying of tanks.

– Calculation of vertical distribution bar section per metre length of wall:

$$A_{\text{vertical}} = 1/3 \times A_{\text{horizontal}}$$

– Reinforcement of base, see Section 2.2.4.2.

All these calculated sections ( $\text{cm}^2$ ) can be converted into real sections (bar diameter and mesh) using Table XXXV.

**Table XXXV: Simplified calculation for a small-capacity covered circular tank (< 200 m<sup>3</sup>).**

#### DATA

##### Geometrical characteristics

Depth of water in the tank	4 m
Internal diameter of the tank	6 m
Capacity of the tank	113 m <sup>3</sup>

##### Bars available in the field

Diameter of main bars	12 mm
Diameter of distribution bars	8 mm

#### RESULT OF THE CALCULATIONS

##### Dimensions

Thickness of vertical walls	10 cm
Actual height of tank	4.3 m
External diameter of tank	6.2 m

Reinforcement with horizontal sections of 1 m<sup>1</sup> ( $A$  = bar section in  $\text{cm}^2$ )

Section	PR (kg)	$A_{\text{horizontal}}$ calculated ( $\text{cm}^2$ )	$A_{\text{horizontal}}$ actual (12-mm bar) mesh (cm)	$A_{\text{vertical}}$ calculated ( $\text{cm}^2$ )	$A_{\text{vertical}}$ actual (8-mm bar) mesh (cm)
0-1 m	1 800	2	57	1	30
1-2 m	5 400	4	29	2	30
2-3 m	9 000	6	19	2	15
3-4 m	12 600	8	15	3	15

1. The mesh must be between 10 and 30 cm: if more or less steel is required, it is necessary to change the diameter of bars used, rather than go outside these limits.

### 3.2.3.5 Rectangular tank

For tanks of a capacity lower than 100 m<sup>3</sup>, that are covered and with a link between the walls and the slab, simplified reinforcement calculations are applicable (Table XXXVI). The main bars are the vertical bars which resist the water pressure on the walls, and the horizontal bars are the distribution bars.

**Table XXXVI: Simplified calculation of a covered rectangular tank of a capacity less than 100 m<sup>3</sup>.**

#### DATA

##### *Geometrical characteristics*

Depth of water in tank	3 m
Internal width of tank	6 m
Internal length of tank	4 m
Capacity of tank	72 m <sup>3</sup>

##### *Bars available in the field*

Diameter of main bars	16 mm
Diameter of distribution bars	12 mm

#### RESULT OF THE CALCULATIONS

##### *Dimensions*

Maximum bending moment	4 500 kg.m
Thickness of vertical walls	14 cm
Actual height of tank	3.3 m
External width of tank	6.28 m
External length of tank	4.28 m

##### *Wall reinforcement<sup>1</sup>*

Calculated section of main bars per m length	23 cm <sup>2</sup>
Actual diameter of main bars	16 mm
Actual mesh of main bars	9 cm
Calculated section of distribution bars per m height	8 cm <sup>2</sup>
Actual diameter of distribution bars	12 mm
Actual mesh of distribution bars	15 cm

1. The mesh must not be greater than 30 cm; if less steel is required, the diameter of the bars must be reduced, rather than exceeding this mesh size.

Maximum bending moment due to thrust of water on the vertical wall:

$$M_{\max} = \frac{\rho \times H^3}{6}$$

where  $M_{\max}$  is in kg.m,  $\rho$  is the density (kg/m<sup>3</sup>), and H the water height (m).

Thickness of the wall as a function of  $M_{\max}$

$$t = 2 \times \sqrt{\frac{M_{\max}}{100}}$$

where  $M_{\max}$  is in kg.m and t is in cm.

Section of the vertical bars for 1 metre length of wall:

$$A_{\text{bar}} = \frac{M}{\tau_{\text{steel}} \times Z}$$

where A is bar section (cm<sup>2</sup>),  $M = M_{\max}$  (kg.cm),  $z = 7/8 \times t$  (cm) and  $\tau_{\text{steel}} = 1\,650$  kg/cm<sup>2</sup>.



Section of horizontal bars per metre height of wall:

$$A_{\text{horizontal}} = \frac{1}{3} \times A_{\text{vertical bar}}$$

Reinforcement of the base, see Section 2.2.4.2.

### 3.2.3.6 Elevated rectangular tank

The calculation is identical to that given above (see Section 3.2.3.5), except for the base slab of the tank and the pillars (for quick determination tables, see Section 2). Static loads correspond to the sum of the weight of water, the walls, and the reinforced-concrete slabs (cover and base).

The example given in Figure 37 and Table XXXVII is a tank made up of 5m<sup>3</sup> modules which are added to one another to increase the capacity (5, 10, 15 m<sup>3</sup>). During construction it is imperative to build suitable foundations (there is a heavy loading on each pillar), as well as a belt linking the pillars to the base.

It is also necessary to ensure that the pillars are perfectly perpendicular. This is facilitated by intermediate chaining every 2 m for structures higher than 3 m.

**Table XXXVII: Simplified calculations for a small-capacity elevated rectangular tank (5 m<sup>3</sup> module).**

---

#### DATA

##### *Geometrical characteristics of a module (supported tank)*

Height of bearing structure	3 m
Height of tank	2 m
Width	1.5 m
Length	2 m
Capacity	5 m <sup>3</sup>

#### TANK DIMENSIONS

##### *Walls*

Thickness	10 cm
Vertical reinforcement	12 mm dia / 10-cm mesh
Horizontal reinforcement	8 mm dia / 13-cm mesh

##### *Base slab*

Thickness	10 cm
Main reinforcement	12 mm dia / 10-cm mesh
Distribution reinforcement	8 mm dia / 13-cm mesh

##### *Cover slab*

Thickness	8 cm
Main reinforcement	8 mm dia / 15-cm mesh
Distribution reinforcement	8 mm dia / 30-cm mesh

#### DIMENSIONING OF SUPPORT STRUCTURE

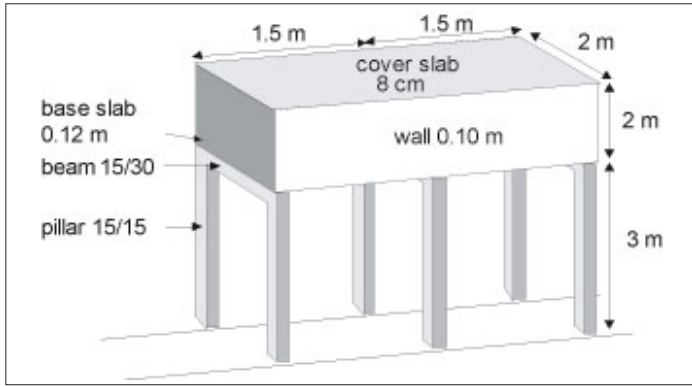
##### *Beams*

Span	1.5 m
Section	15 x 30 cm
Main reinforcement	2 bars of 12 mm dia

##### *Pillars*

Height	3 m
Section	15 x 15 cm
Main reinforcement	4 bars of 12 mm dia

---



**Figure 37: Elevated rectangular tank.**

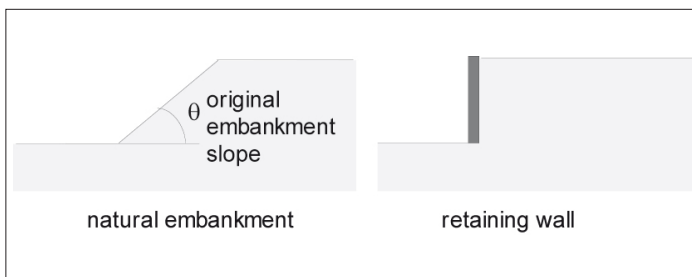
### 3.2.3.7 Reinforced-concrete retaining walls

Features of the slope to be retained, to be considered in designing a retaining wall, are as follows (Figure 38 & Table XXXVIII):

- $\theta$ , the natural angle of the soil embankment before construction of the wall. The smaller the value of  $\theta$ , the less stable the soil and the more difficult it will be to retain;
- $A$ , the thrust coefficient, which takes account of the soil type, and therefore  $\theta$  and  $\tau_{\text{soil}}$ ;
- $f$ , the coefficient of friction, which characterises the resistance to motion of the concrete relative to the soil (the smaller the value of  $f$ , the greater the tendency of the base of the wall to slip because of the ground thrust);

**Table XXXVIII: Soil characteristics to be included in the design of an embankment retaining wall.**

Type of soil	$\rho_{\text{soil}}$ ( $\text{kg/m}^3$ )	$\theta$ original slope	$A$ coefficient of thrust	$f$ coefficient of friction
Humus-rich soil	1 450	45	0.171	
Clay soil	1 800	45	0.171	
Brick earth	1 900	55	< 0.130	
Fine sand	1 420	30	0.333	
Sandy soil	1 700	35	0.270	
Clay and mud	1 850	20	0.490	
Stones, gravels	1 550	45	0.171	
Wet clay				0.3
Dry clay				0.5
Sand				0.4
Gravel				0.6



**Figure 38: Retaining wall for an embankment.**

– Q, the of ground thrust, calculated by:

$$Q = A \times \rho_{\text{soil}} \times \frac{h^2}{2}$$

where the non-dimensional coefficient A is a function of the original earth slope angle,  $\rho_{\text{soil}}$  is the specific weight of the soil, and h is the height of the wall (Figure 39). The forces acting on the wall are P (static weight of the wall, weight of the earth on the sole, plus any extra loading from the embankment) and Q (ground thrust).

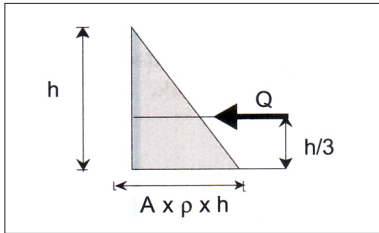


Figure 39: Ground thrust on a retaining wall.

Moments to be considered are:

- overturning moment ( $M_r$ ), a function of thrust Q and the lever arm in relation to the overturning point ( $M_r = Q \times z_r$ );
- stabilising moment ( $M_s$ ), a function of weight P and the lever arm in relation to the overturning point ( $M_s = P \times z_s$ ).

For the calculation of retaining walls, the conditions of non-overturning and non-sliding should be fulfilled (Figures 40 & 41).

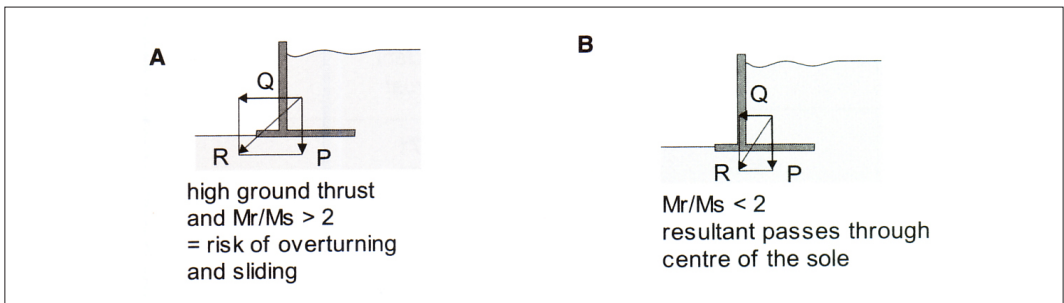


Figure 40: Conditions of non-overturning and non-sliding.

A: non-overturning ( $M_r/M_s < 2$ ). B: non-sliding ( $Q/P < f$ ).

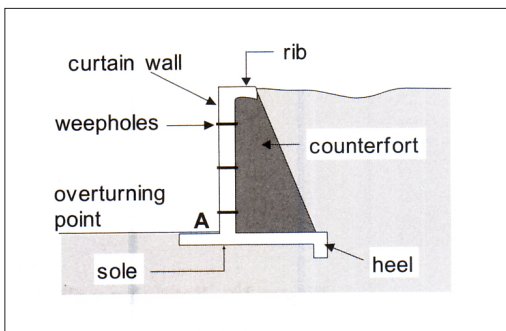


Figure 41: Standard configuration of reinforced-concrete retaining walls.

Weephole made every 2 – 3 m<sup>2</sup> to avoid accumulation of water (which adds to ground thrust); heel, an anchorage opposing sliding caused by ground thrust; counterfort, an element ensuring rigidity and providing lateral anchorage; sole, foundation stretching in front of the curtain wall to ensure better distribution of pressure on the ground.

### 3.2.3.8 Simplified calculation of a retaining wall in reinforced concrete

This wall is shown in Figure 42.

– Assumptions:

- $\rho_{\text{soil}} = 1\,600 \text{ kg/m}^3$
- $\theta = 35^\circ$
- coefficient of friction  $f = 0.35$
- overturning point A, (lever arms  $Z_r$  and  $Z_s$  are calculated in relation to this point)

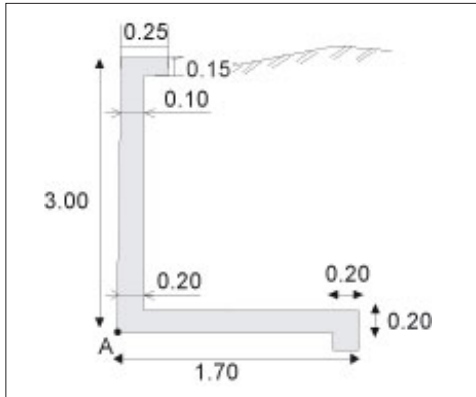


Figure 42: Reinforced-concrete retaining wall.

– Vertical load calculation:

- curtain wall:  $P_{\text{curtain}} = (0.1 + 0.2)/2 \times 2.8 \times 2\,500 = 1\,050 \text{ kg/m}$
- earth:  $P_t = 2.8 \times 1.5 \times 1\,600 = 6\,720 \text{ kg/m}$
- sole:  $P_s = 1.7 \times 0.2 \times 2\,500 = 850 \text{ kg/m}$
- total vertical loads:  $P = 8\,620 \text{ kg/m}$

– Calculation of stabilisation moment:

$$\text{moment} = \text{force} \times Z$$

where the moment is in kg.m, force in kg/m length, and lever arm Z between the line of action of the force and the overturning point A. Here, for 1 metre length of wall:

- curtain wall:  $M_{\text{curtain}} = 1\,050 \times 0.12 = 126 \text{ kg.m}$
- earth:  $M_{\text{earth}} = 6\,720 \times (1.50/2 + 0.20) = 6\,384 \text{ kg.m}$
- sole:  $M_{\text{sole}} = 850 \times (1.70/2) = 722.5 \text{ kg.m}$
- stabilisation moment:  $M_s = 7\,232.5 \text{ kg.m}$

– Calculation of thrust - horizontal forces:

- $Q = 0.27 \times 1\,600 \times (3^2/2) = 1\,944 \text{ kg/m}$  length of wall

– Calculation of overturning moment:

The thrust applies to  $h/3$ , i.e. 1 m above A:

- thrust:  $M_r = 1\,944 \times 1 = 1\,944 \text{ kg.m}$
- overturning moment:  $M_r = 1\,944 \text{ kg.m}$

– Verification of the two main criteria:

- non-overturning condition: ratio between stabilisation and overturning moments ( $M_{\text{stab}}/M_{\text{overt}}$ ) must be greater than 2. This condition is clearly fulfilled here:

$$\frac{M_{\text{stab}}}{M_{\text{overt}}} = \frac{7\,232.5}{1\,944} = 3.7$$

- non-sliding condition: the ratio of vertical to horizontal forces must be less than the coefficient of friction, as here:

$$\frac{Q}{P} = \frac{1\,944}{8\,620} = 0.23$$

which is less than that of  $f$  (0.35).

- Determination of curtain-wall reinforcement:

- calculation of the maximum moment in the curtain wall:

$$\text{moment}_{\max} = \frac{Q \times h}{3}$$

- calculation of the main bar section:

$$A_{\text{steel}} = Q \times h/3 / \tau_{\text{steel}} \times z$$

where  $Q$  is the ground thrust (kg/m length),  $h$  wall height (m),  $z$  lever arm in wall (20 cm thick) and  $\tau_{\text{steel}}$  stress limit of the reinforcement bars (kg/cm<sup>2</sup>):

$$A_{\text{steel}} = \frac{Q \times h/3}{\tau_{\text{steel}} \times z} = \frac{1\,944 \times 2.8/3}{1\,650 \times 17.5} \approx 7 \text{ cm}^2$$

- conversion to an actual reinforcement section

*main bars:* 10 mm dia / 11.5 cm mesh

every other bar interrupted at mid-height

*distribution bars:* 8 mm dia / 20 cm mesh for lower part

6 mm dia / 20 cm mesh for upper part

sole reinforcement: as for curtain wall

## 4 Shuttering

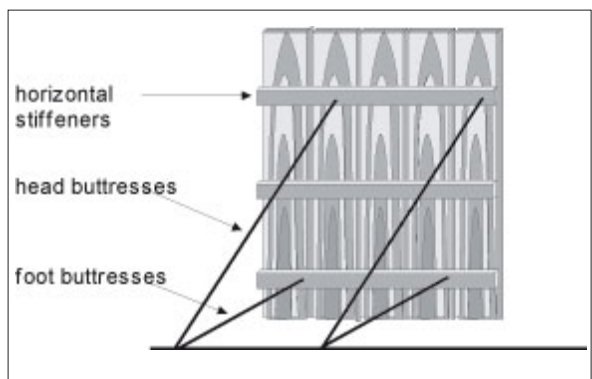
The dimensions of the shuttering are determined by the structure to be built and the type of shuttering to be used (sliding shuttering, tank wall shuttering etc.). Shuttering has to take high static loads as well as significant dynamic loads due to vibration of the concrete. At the time of the design and use of the shuttering, it is therefore necessary to consider:

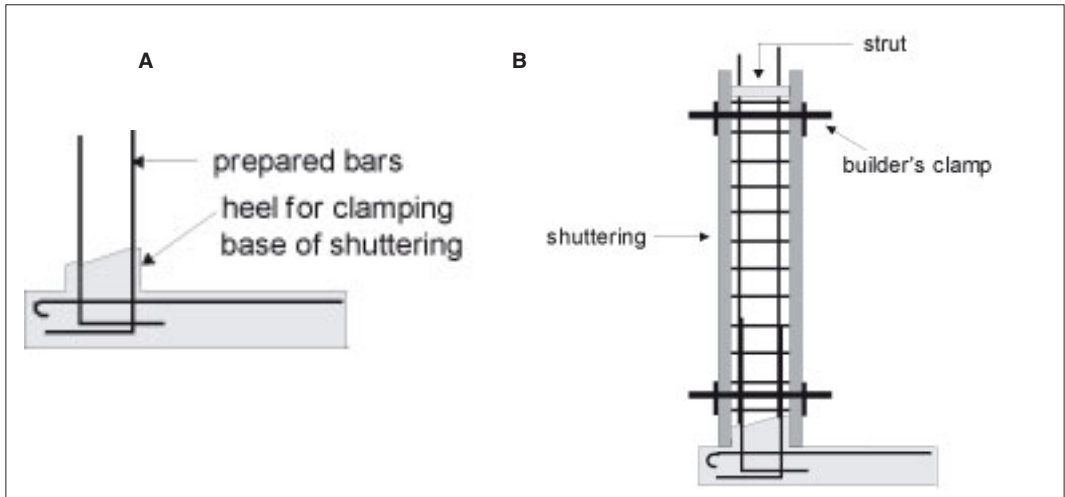
- stresses during casting of the concrete;
- sealing;
- ease of vibration of the concrete (internal and external vibration);
- surface finish required;
- ease of removal and re-use.

### 4.1 Wooden shuttering

This type of shuttering is cheap, easy to use and easy to modify (Figures 43, 44, and Box 6). It allows the concrete to dry slowly, and produces a rough surface finish which provides a key for a surface coating. The tools required for putting up and taking down the shuttering are stays, (generally wood), clamps and builder's hooks.

**Figure 43: Wooden shuttering with buttressing and vertical and horizontal stiffeners to prevent deformation under the weight of concrete.**





**Figure 44: Shuttering for a pillar or curtain wall.**

**A:** awaiting shuttering and reinforcement. **B:** shuttering and reinforcement in place.

## 4.2 Metal shuttering, well moulds

This type of shuttering is commonly used for jobs requiring precision, a smooth surface finish, and multiple re-use of the shuttering. Examples of applications are for producing concrete rings, (Figure 45), cutting rings (Figure 46), well linings (Figure 47) or headwalls (Figure 48). They must be stored upright to prevent deformation.

## 5 Estimation of work time

Work times calculated for different jobs are shown in Table XXXIX.

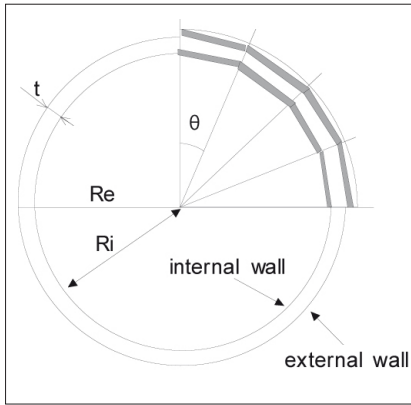
**Table XXXIX: Work times for standard jobs.**

Excavation	
Plain soil	1.8 m <sup>3</sup> /person/day
Gritty soil	1.3 m <sup>3</sup> /person/day
Soft rock	0.6 m <sup>3</sup> /person/day
Hard rock	0.4 m <sup>3</sup> /person/day
Rock crushing (production of gravel)	14 men/m <sup>3</sup> /day
Mixing and handling concrete	1 mason and 4 labourers/m <sup>3</sup> /day
Blockwork masonry	1.4 masons and 3.2 labourers/m <sup>3</sup> /day

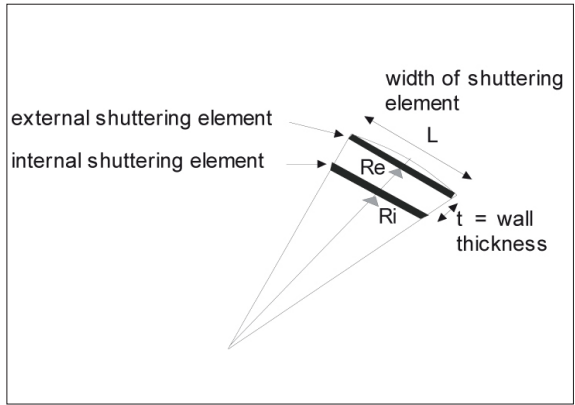
**Box 6**

**Calculations for circular shuttering in 16 elements.**

For a circular tank in 16 elements (Figure 1), the geometric features of one shuttering element are determined initially (Figure 2). Here, the angle of a shuttering element  $\theta = 2\pi / 16 = 23.75^\circ$ .



**Figure 1: Shuttering for a 16-element circular tank.**



**Figure 2: Geometric projection of a shuttering element.**

The width of the interior shuttering element is  $L_i = 2R_i \tan \alpha$ . The width of the outside shuttering element is  $L_e = 2R_e \tan \alpha$ , with angle  $\alpha$  equal to  $\theta/2$ , and  $R_e$  and  $R_i$  the external and internal radii such that  $R_e = R_i + t$ .

Example for a tank of 3 m diameter and 3.5 m height (Figures 3 & 4) :

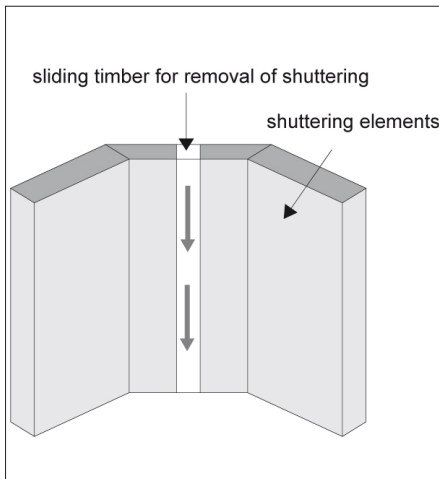
$$\theta = 2 \times \pi / 16 = 23.75^\circ$$

$$\alpha = \theta / 2 = 11.8^\circ$$

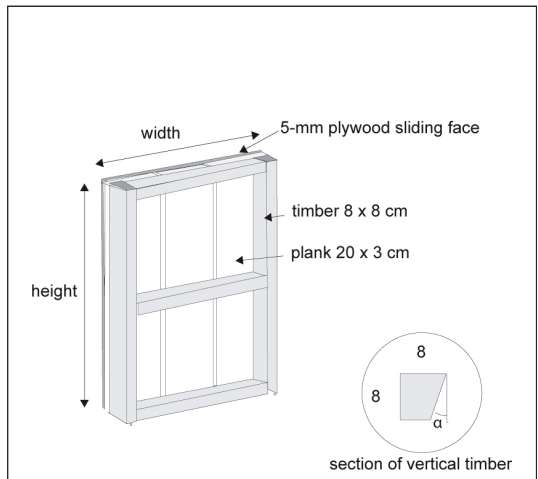
$$L_i = 2 \times 1.5 \times \tan 11.8 = 0.626 \text{ m}$$

$$L_e = 2 \times (1.5 + 0.1) \times \tan 11.8 = 0.668 \text{ m}$$

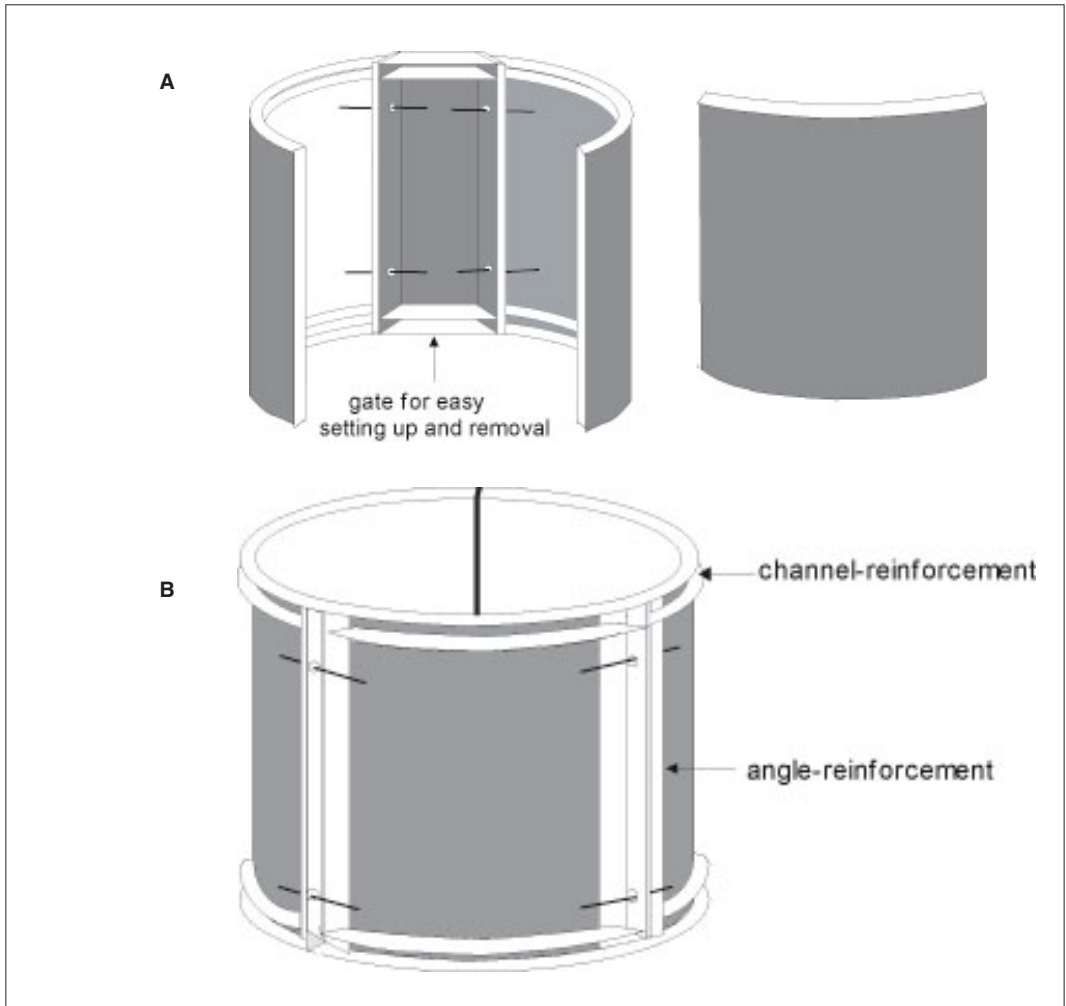
$$t = 10 \text{ cm}$$



**Figure 3: Interior shuttering, either to the full height of the tank, or sliding (several passes).**



**Figure 4: Sliding timber in one element for the removal of shuttering (probably several will be needed).**



**Figure 45: Metal shuttering for a concrete-ring mould.**  
**A: internal mould. B: external mould.**



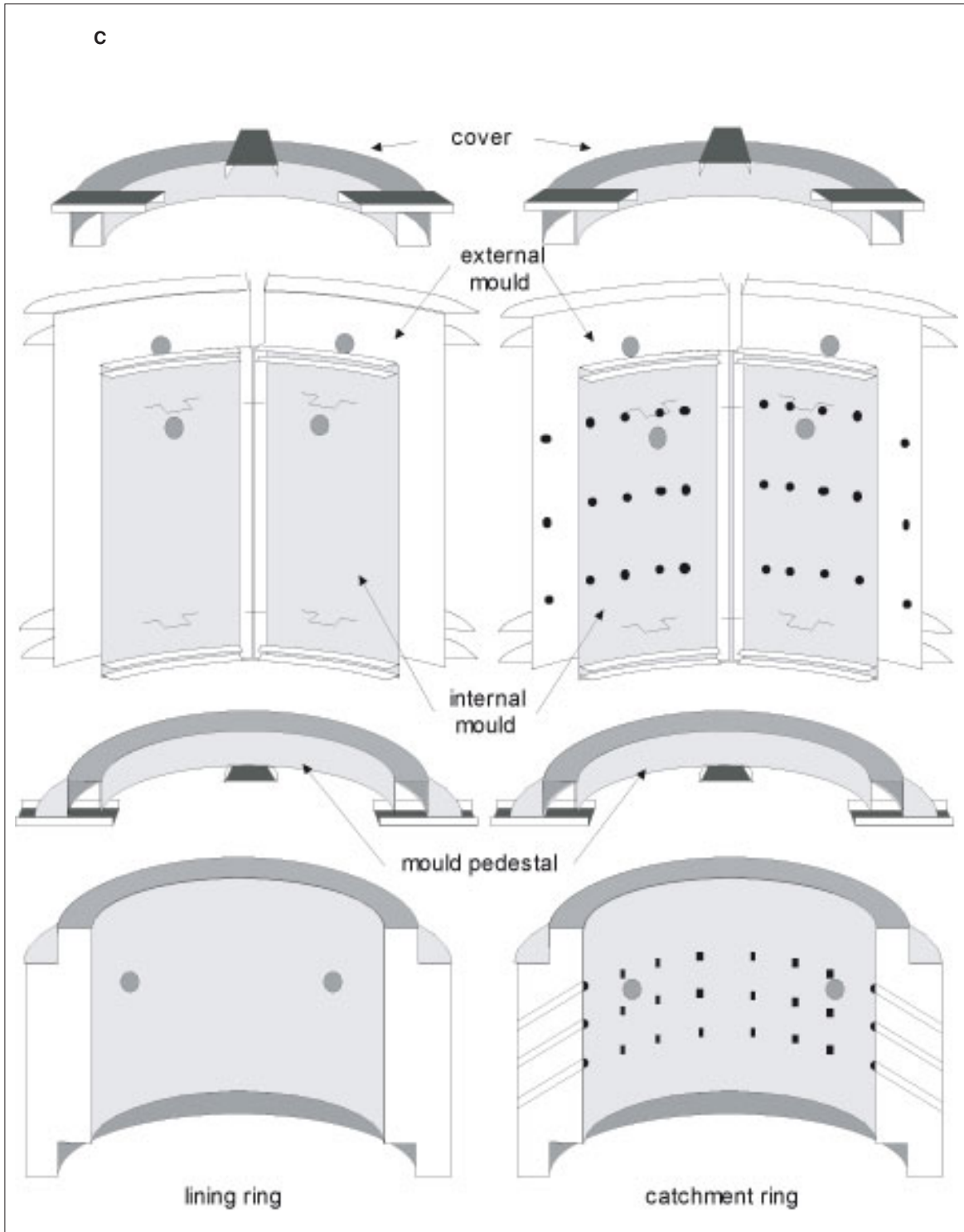
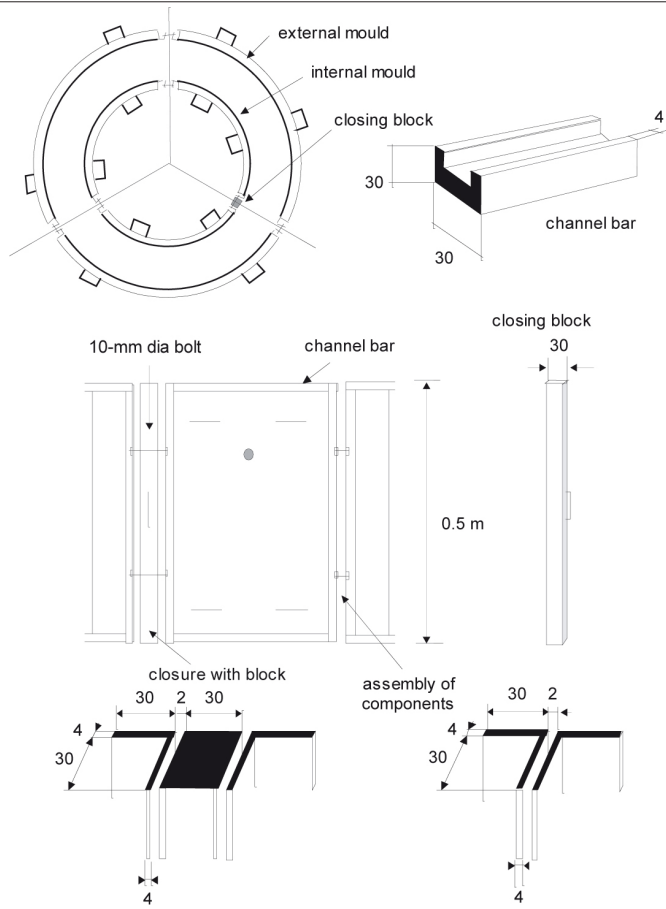


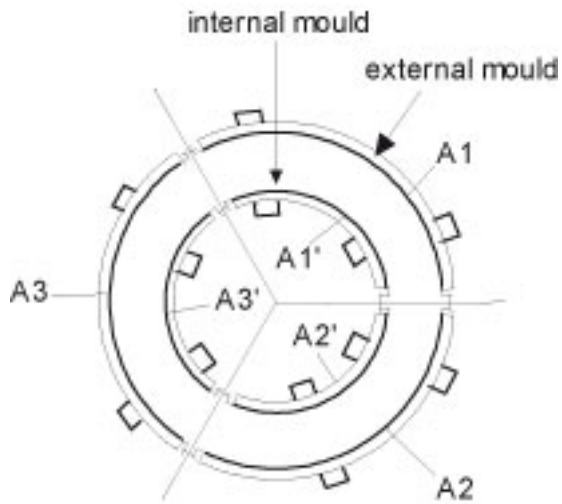
Figure 45: Metal shuttering for a concrete-ring mould.

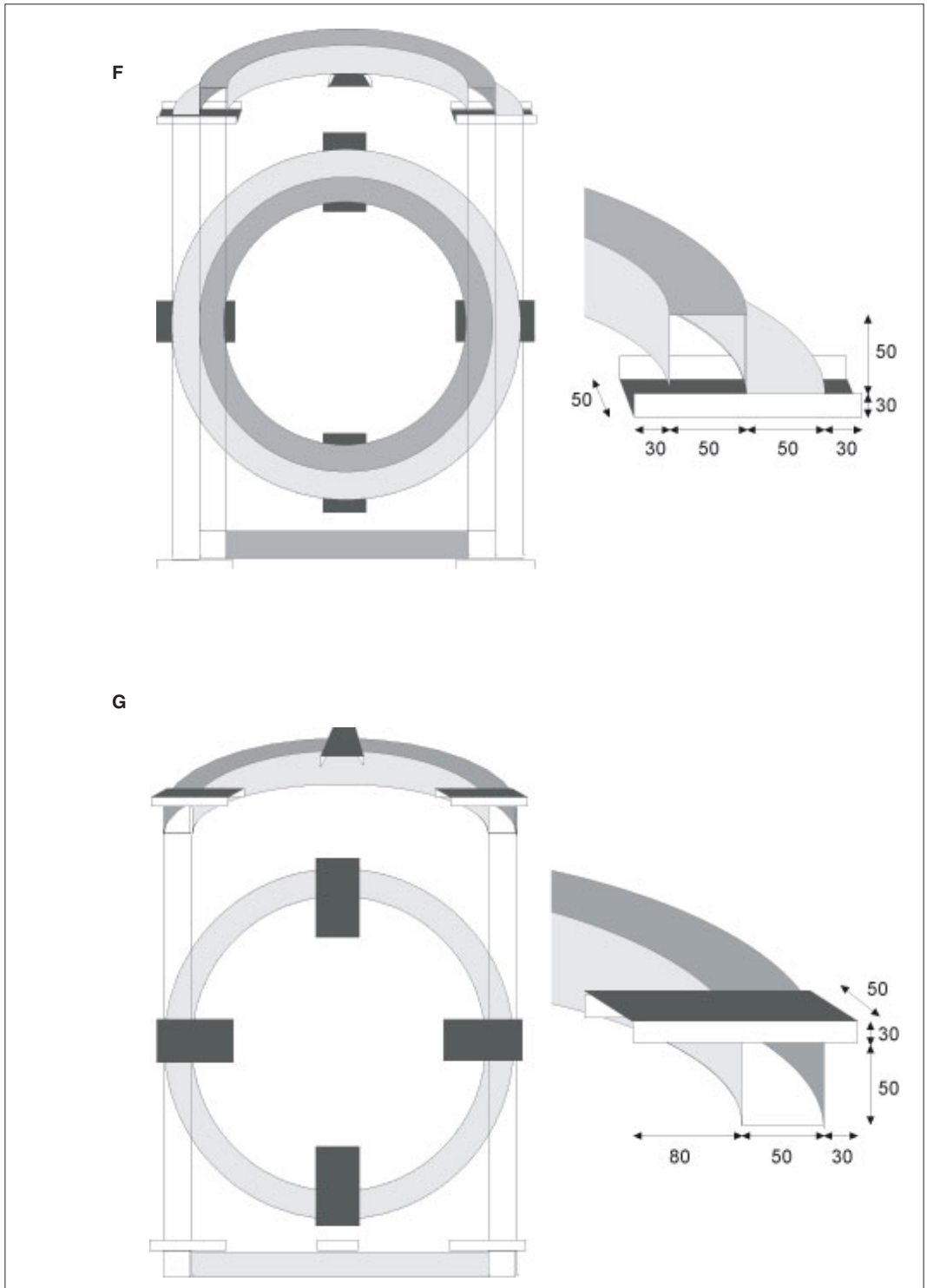
C: various parts of the mould. D: assembly details. E: numbering of various parts of the mould.

D

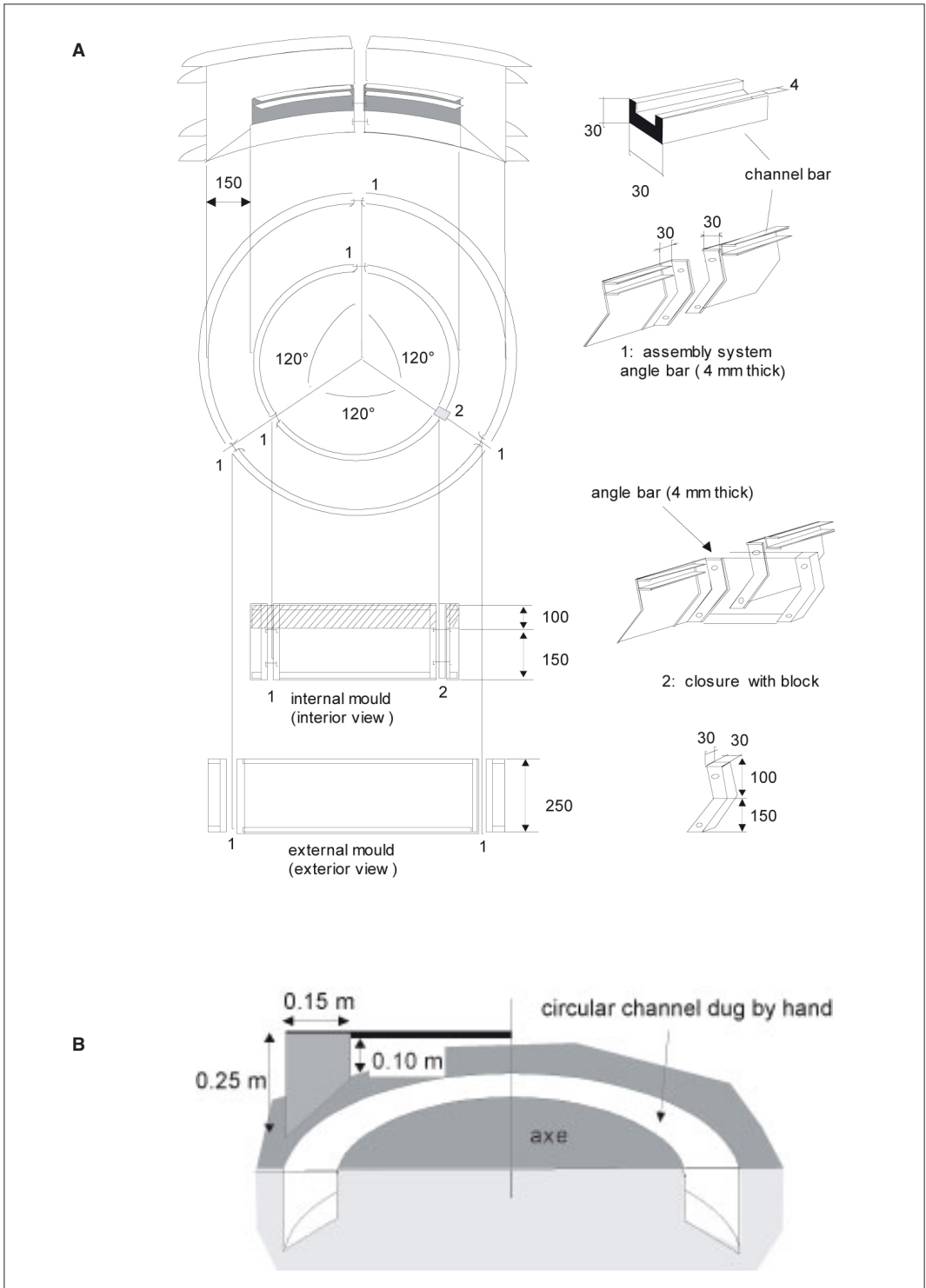


E





**Figure 45: Metal shuttering for a concrete-ring mould.**  
**F: pedestal. G: cover.**



**Figure 46: Shuttering for cutting ring.**  
**A: metal. B: mould made directly in the ground**

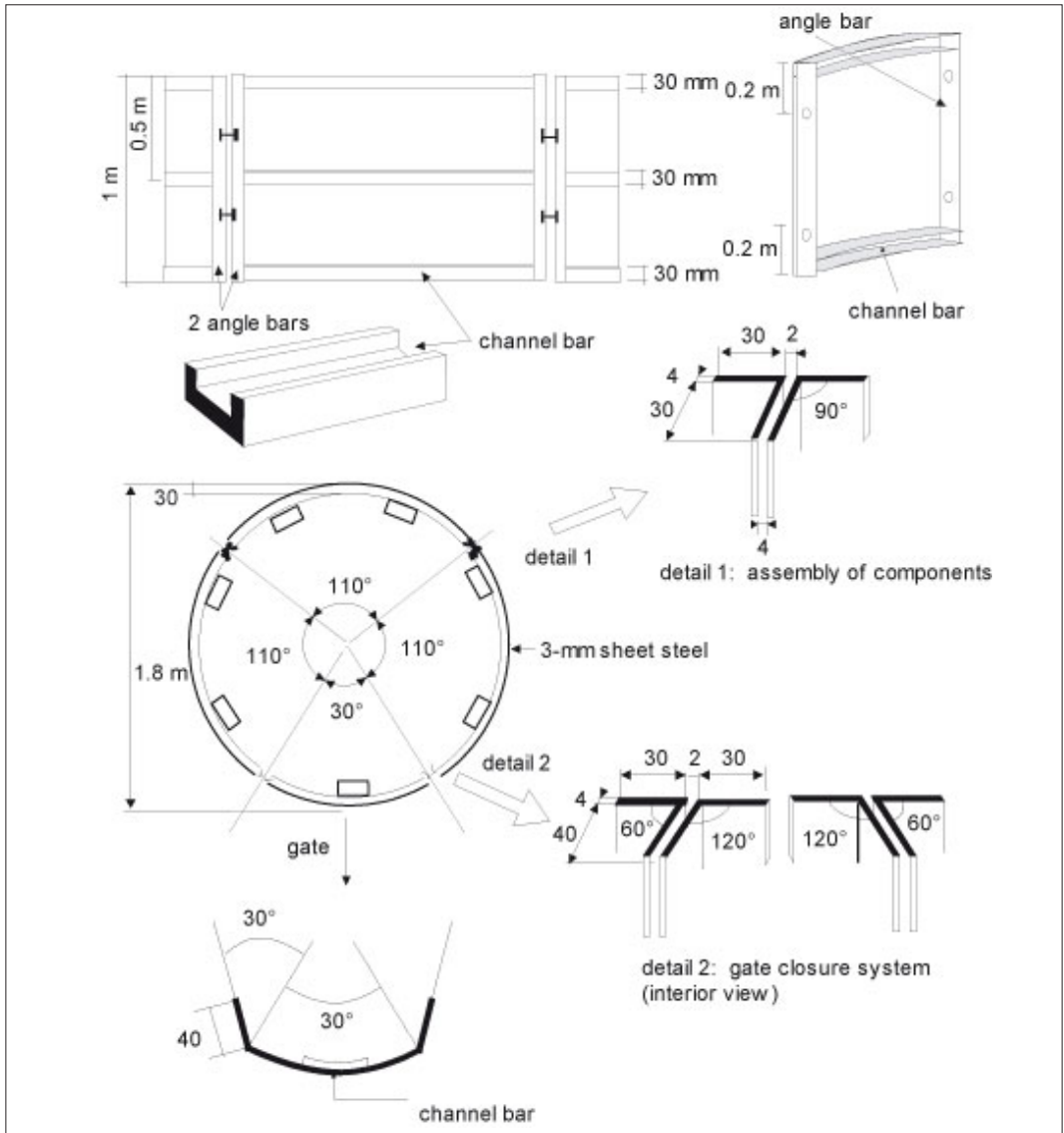


Figure 47: Sliding shuttering for a 1.8-m diameter well.

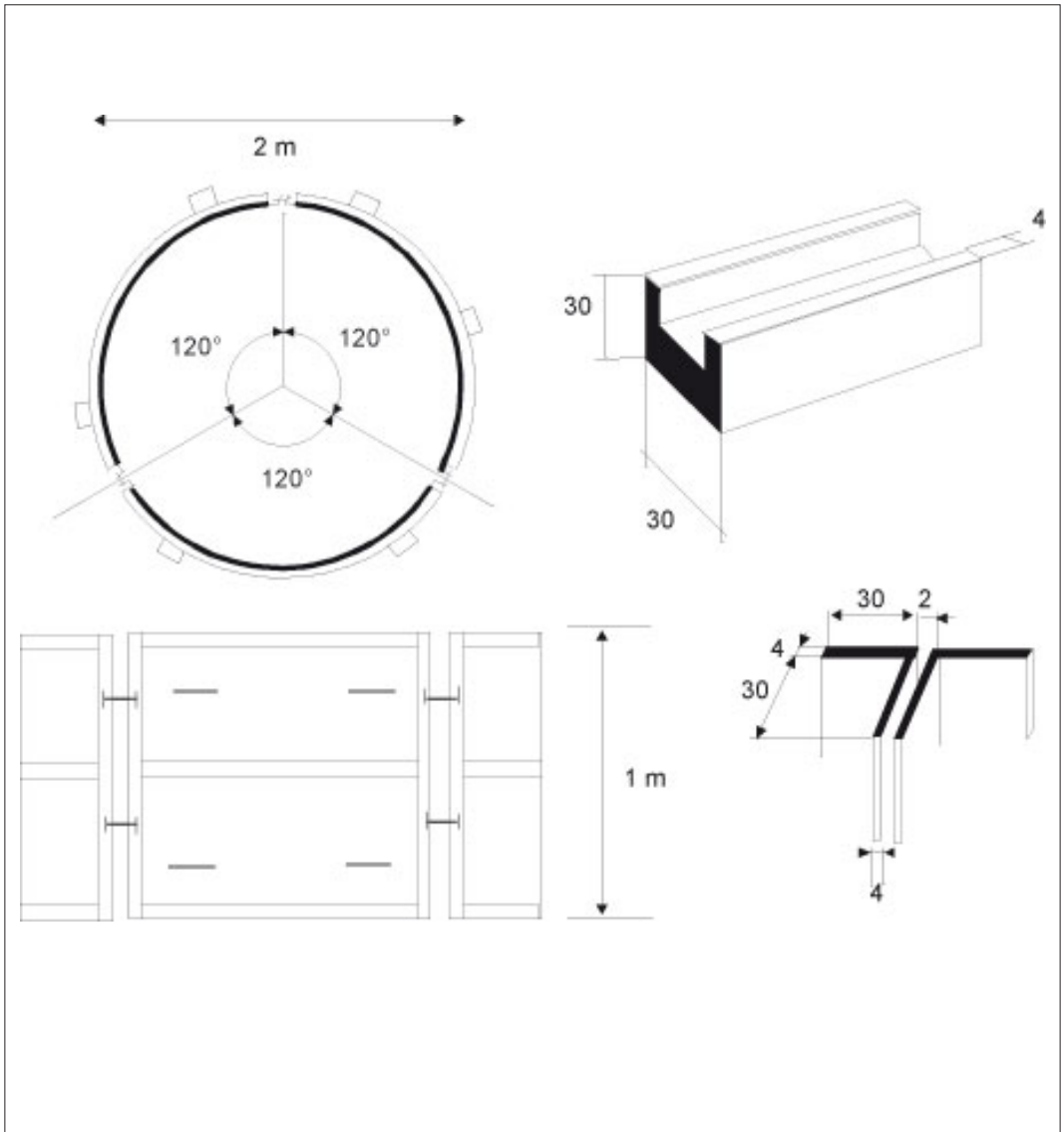


Figure 48: Shuttering for a headwall (2 m external diameter)



# Index

- Acceptance (water quality) 101, 115, 118, 120-122, 648, 681
- Access to sanitation 47
- Access to water 3, 9, 11-12, 35, 49, 63, 179, 262, 275, 286, 383, 385, 575, 577, 580-582, 589, 612, 625, 632, 648
- Acidity 115, 507
- Adjustable stop-cock 404, 417
- Advocacy 577, 580, 655
- Aeration 119, 403, 451, 550
- Aerobic biological process 104-105, 120-121, 483-484, 488
- Air vents 402, 404, 417
- Air-lift development 135, 184, 194, 302, 305, 312
- Alternating pumping 304-305
- Aluminium 439, 444-445, 587, 734
- Aluminium sulphate 116, 436, 442-445, 453, 587, 598, 734
- Amoebiasis 663
- Anaerobic digestion chamber 104, 478-479
- Anaerobic process 105, 120-121, 476
- Annual rainfall 614, 627
- Appraisal techniques 21, 23, 31, 33, 38, 544-545, 547
- Apron 102, 595, 612
- Aqua-privy 478
- Aquifer 463, 575, 614, 617, 625, 675-678, 691  
confined aquifer 78-80, 85, 91, 152, 172-174, 200, 211-213, 216, 222, 233, 235, 299, 325, 364, 676  
head-losses 211, 213, 221-223, 227, 272, 282, 300, 308, 310, 312, 334-344, 364, 388, 392-398, 437, 442, 671, 724-726, 728  
hydraulic conductivity 81-82, 173, 211, 310  
permeability 81, 84, 86, 90-93, 132, 162, 173-175, 199, 205-208, 236, 252, 301, 308, 524, 627  
recharge 83, 93-94, 177, 205, 213-215, 218, 235-236, 617, 672, 675-676, 678  
recovery 190, 194, 200, 215, 218-221, 225, 228-237  
stock 11, 15, 17, 34-35, 58, 93-97, 106, 444, 447-449, 676-678, 716  
storativity 78, 80, 88, 168-174, 177, 199-203, 211-212, 235  
transmissivity 81-85, 87, 105, 132, 168-177, 190-196, 200-203, 206-221, 231-235  
unconfined aquifer 80, 83, 89-93, 131, 172-174, 200-201, 211-216, 222, 233, 235, 258, 299, 364
- Arsenic 94, 99-103, 106-108, 121, 123, 127
- ASAL (Arid and Semi-Arid Lands) 11, 190
- Assessment 15, 25-34, 38-39, 45, 54-56, 62, 70, 80, 93, 112, 115, 177, 384, 388, 460-461, 483, 512, 544-550, 557, 559-565, 572, 576, 593, 610, 615-616, 646, 651, 685
- Assessment team 26, 29, 31-32, 545, 557, 559-560
- Atmosphere 68, 70, 103, 120, 391, 669, 730
- Attack rate 513, 515, 532, 536, 645
- Backfilling 257, 414
- Back-pressure 367, 396
- Bacteria 27-28, 99, 103-106, 109, 114-115, 120-125, 299, 308-309, 443, 463, 476, 496, 507, 547, 661-662, 687
- Bacteriological analysis 109, 114-115, 124-125, 129, 266, 314, 439, 442, 535, 685, 687, 707
- Bailing 312
- Ball valve 401, 404, 417, 611
- Bar 248, 251-252, 328, 375, 377
- Base river flow 103, 677
- Baseline 39, 511, 545, 593
- Beams 252, 287, 740, 746-747, 758-759, 762-763
- Behaviour change 48, 543-544, 547, 550, 562-564, 567, 572
- Behaviour trials 562, 564
- Beliefs 18-19, 37, 460-462, 543, 652, 658
- Bending moment 760, 762-763, 767
- Beneficiaries 23-24, 39, 46-47, 53-56, 60, 63, 578
- Bentonite 267, 289, 301, 305
- Bernoulli's theorem 671
- Biological indices 122, 463, 468, 483, 510
- Birkads 70, 371, 614-615, 617, 629
- Black-water 37, 459, 475, 477
- BOD 116, 124
- Boiling 37, 547, 571, 573, 625
- Boreholes 54, 57, 70, 81-87, 90, 93-94, 100-105, 119-121, 128-140, 149, 158-159, 163, 170-172, 177-180, 184-188, 189-205, 214, 217-219, 22, 225-227, 231, 233, 237-238, 242, 265-275, 282-328, 335, 342, 353, 359, 434, 451, 532, 614, 616-617, 627, 672, 705, 707, 709  
casing plan 81, 237, 297, 299, 305, 309  
exploitation borehole 140, 267  
exploitation flow 227, 282-283, 293, 342, 434, 610  
log sheet 309  
prospection borehole 266, 315  
shroud 283, 299  
slots 283, 297, 299-300, 308-309
- Borehole rehabilitation 7, 8-11, 54, 102, 130, 212, 222, 255-256, 307-314, 532, 535, 609  
bailing 312  
clogging 307-309, 312



- corrosion 283, 308, 359, 361, 451
- de-watering of screens 220, 223, 226, 299, 305
- incrustation 309-310
- over-drilling 312
- polyphosphates 313
- re-equipment 307, 312
- sand intrusion 308, 328
- unclogging 307, 312
- video-camera 310
- Boundary effect 89, 211-215
- Braithwaite-type tank 434
- Break-pressure tank 391-392, 397, 401-403
- Burial 500, 503
- Cable-tool drilling 267, 312
- Calcium 117-119, 681, 733
- Camps 20, 69, 98, 225, 266, 437, 458, 461, 465, 489, 491, 493, 510, 516, 534, 582, 603-604, 613, 616, 672
  - camp layout 384, 386, 606
  - tapstands 385-386, 390, 397, 399, 401, 409-410, 413, 417-418, 421, 434-435
- Capacity-building 11-12, 18, 48, 55-56, 60, 484, 656-658
- Capillary effect 78
- Caretaker 584-585
- Cashbox 591
- Casing 81, 207, 266, 271, 282-284, 290, 294, 297-305, 312, 325-328, 333, 360, 716
  - Casing plan 297, 299, 305, 309
- Catchment area 70, 102, 112, 585, 629, 631
- Catchment basin 177, 625, 627
- Catchment tank 370, 392
- Catchment technique 363-367, 372, 384, 387, 390, 395-396, 398, 420, 422
- Cattle trough 632
- Ceramic-candle filter 450
- Chain pipe wrench
- Chemical analysis 96, 99, 126, 266, 304, 307, 310, 312, 314, 439, 610, 648
- Chemical dosing 443-444, 453
- Children 3, 11, 15, 20, 24, 27, 31, 48, 108, 120, 122, 458, 461-462, 472, 491, 500, 507, 519, 547, 549, 558, 562-568, 573-574, 619, 621, 646, 662
- Chlorides 103, 106, 117-119, 123
- Chlorination 99, 116, 118, 434, 436, 438, 444, 446-449, 520, 532, 534-536, 587, 589, 613, 621
  - chlorinating wells 535
- Chlorine 47, 99, 122-125, 312-313, 434-439, 446-450, 453, 476, 514-515, 520-522, 527, 530-532, 570, 598, 613, 621, 639, 707, 733
  - active chlorine 313, 447-448, 733
  - chlorine demand 442, 446
  - residual chlorine 99, 125, 439, 442, 446-450, 520, 532, 587, 613, 621, 639, 649
- Cholera 15, 27, 434, 458, 489, 505-537, 570, 605, 611, 640, 659, 661-662
- Clinometer 389
- Coagulant 442-444, 453, 621
- COD (Chemical Oxygen Demand) 116
- Colebrook-White 335, 393, 726
- Coliforms 99, 102, 108-109, 115, 125-126, 639
  - faecal 99, 102, 108-109, 115, 125-126, 642, 648, 687
  - total 115, 125
- Colour (water) 309-310, 443, 648
- Combined well 219, 225, 325, 327-328
  - central combined well 325
  - lateral combined well 325, 328
- Communication 563-567, 658
  - channel 531, 546-547, 564-565
  - plan 565, 569
- Community 3-9, 15-20, 26, 31-34, 43, 53-63, 98-99, 101, 255, 266, 359, 385, 387-388, 421, 460-465, 467-474, 479, 483, 493-495, 497, 500, 502, 508, 512, 531, 534, 537, 539, 546, 550, 557-569, 576-598, 609, 616, 628-629, 633, 656-658
  - approach 560, 576, 581, 657-658
  - environment 460-461, 546, 549-550, 558, 564
  - management 461, 539, 576-582, 586-597, 633
  - mapping 558
  - participation 17, 56, 60, 260, 360, 420, 461-462, 497, 534, 553, 565-566, 576-577, 580, 582, 586-587, 594-595, 628
- Community-based management 587-588, 595-596
- Compost latrine 464, 482-485, 488, 651
- Composting 464, 482-488
- Compressive stress 758-759
- Concrete 68, 69, 241-242, 247-252, 255-258, 308, 313, 326, 328, 360, 364, 374-379, 403-404, 414-418, 442, 468, 470-471, 480, 486, 489, 493, 497, 521-522, 658, 735-737, 740-745, 749-750, 754, 757-767, 771-773
  - concrete joint 742
- Conductivity 73-76, 81-82, 95, 99-106, 116-118, 123-127, 136, 140, 160-161, 173, 179-181, 186, 198, 196, 198, 211, 237, 310, 675, 730
- Connector tap 287
- Constant-level channel 81, 374, 380
- Contamination 3, 11, 16, 20, 27, 35, 38-39, 70, 94-109, 112-117, 120, 125, 130, 242-243, 258, 307, 314, 353, 446, 463, 467-468, 473-474, 477, 479, 488-489, 501, 507-512, 515, 524, 527, 529, 535, 537, 547, 575, 583, 586, 595, 625, 629, 631-632, 640, 648, 651, 656, 661, 685
  - faecal contamination 11, 99, 104-109, 114-115, 120, 125, 130, 310, 364, 436, 442, 451, 459, 490, 493, 497, 546, 639, 681, 685, 705
- Contiguous 8
- Continuity equation 671
- Contracts 35, 53, 55-61, 101, 592, 610
- Coping mechanisms 6, 13-15, 34, 545, 614-616
- Cost analysis 197, 537, 562, 584-586, 598, 610, 617

- Cost-recovery 577, 583-586, 596  
 Coutagne's formula 627  
 Culture media 125-127, 687  
 Cuttings (borehole drilling) 159, 189, 237, 262, 267-268, 271-272, 279, 286-287, 290-301, 315  
 Darcy 81-83, 94, 393, 670, 676  
 Darcy's equation 82, 94  
 Defecation field 465, 490-491, 508, 512, 531, 534, 640, 652, 661  
 Defecation trench 490-491, 652  
 Densities of materials 271-272, 289, 409, 736, 741  
 Design 242-243, 251, 282, 349, 356, 359, 363-390, 393, 395, 399, 401-402, 417-418, 460-462, 468-479, 483-489, 491-499, 517, 545, 551, 558, 561-565, 569, 572-573, 577, 586, 589, 595, 598, 610, 615, 619, 621, 625, 627-628, 632, 642, 707, 710, 765, 772  
 Desludging pump 473  
 Destocking (pastoralism) 615-616  
 Development (boreholes/wells)  
 air-lift 302, 304-305, 312  
 alternating pumping 304-305  
 bucket test (stain test) 310  
 drilling-mud cake 267, 271, 293, 297, 301-302  
 instantaneous flow 305, 349-350, 386  
 over-pumping 304, 308  
 pistoning 304, 312  
 sand-bridge 302, 304  
 Dewatering pump 220, 223, 226, 254-255, 257, 346, 436, 473  
 Diagraphy 299, 310  
 Diarrhoea 11, 15, 26-27, 48, 98, 115, 458, 489, 506-508, 513, 534-535, 542, 546-547, 562, 564, 570-573, 605, 639, 659, 661-662  
 Direct approach (beneficiaries) 16  
 Disaster management 6-9, 13, 24, 34, 38, 641  
 mitigation 8  
 preparedness 6-9, 35  
 prevention 8  
 risk management 8, 35  
 Discrimination 4, 6, 8, 57  
 Disinfectant 37, 442, 446, 503, 515, 532  
 Disinfection 99, 116, 118, 122, 130, 258, 435-436, 439, 442, 446, 449, 451, 508, 510, 512-515, 521-524, 526-536, 583, 612-613, 649, 652, 733  
 Displaced persons camps 98, 266, 437, 458, 493, 582, 606, 609  
 Dissolved oxygen 103, 117, 125, 681  
 Distribution plan 368-369, 383-387, 392, 422, 434, 436-439, 451  
 Distribution system 458, 493, 517, 521, 531-532, 582, 586, 594, 609-616  
 Donors 7, 21-24, 35, 52-53, 61, 658  
 Dosatron 434, 453  
 Downstream approach (hydrology) 94, 677, 706  
 Drain dam wall 364  
 Drain valve 401, 417  
 Drainage 37-38, 69, 80, 84-89, 93, 112, 120, 131, 134, 136, 212, 242, 367, 380-381, 459, 468, 475, 493, 496-497, 500, 517, 521, 523-524, 549, 576, 584, 606, 608, 612, 652-653, 706  
 Drainage channel 242, 374, 381, 418, 497, 500  
 Drawdown (pumping) 211-236  
 Drilling 265-279, 283-309, 312, 315-323, 327-328, 676, 709-719  
 drill bit 267-271, 275, 277, 284, 290, 293-295, 710  
 foam 271-272, 284, 290, 293, 710-712  
 foam pump 279, 294, 296, 711-712  
 grouting 300-301, 312, 314, 707  
 log 203, 212-216, 305, 309, 316, 328, 657, 691, 717  
 mud 158-159, 242-243, 267, 269, 271, 284, 289-296, 299-302, 346, 434  
 mud pump 274, 276, 279, 289, 291, 710-711  
 mud pit 286-287  
 PAT 265-267, 274-279, 284-287, 319, 322, 325, 709-712  
 sides collapsing 271, 284  
 three-bladed bit 715  
 tricone bit 267, 270, 276, 715  
 DTH (down-the-hole hammer) 267-276, 279, 284, 290, 293-296, 302, 312, 322, 710-712  
 Dwellings 512, 606, 611, 653  
 Dynamic water level 231, 717-718  
 Dynamic profile 390  
 Dysentery 27, 659, 661-663  
 Educational tools and methods 535, 568, 574  
 Effectiveness 16, 19, 55, 62, 98, 115, 189, 198, 377, 442, 536, 549, 621  
 Efficiency 55, 62, 112, 114, 116, 199, 211, 221-222, 262, 271, 310, 312, 334-335, 338, 344, 346, 349, 352, 453, 466, 477, 479, 484-485, 536-537  
 Elbow 393, 395, 416, 477, 728  
 Electric field 730  
 Embankment 521, 626-627, 769-770  
 Emergency response 8, 24, 38, 53, 307, 370, 410, 435, 442, 446-447, 458, 460, 465, 470, 489, 491, 514, 532, 544, 570, 582, 587, 609, 612, 615, 655, 706  
 Emergency water supply 266, 346, 434-435, 582, 587, 614, 639-640  
 Endemic 434, 507, 509-512, 536  
 Enteritis 659, 661-662  
 Environment 3, 11-27, 70, 81-83, 92-97, 102, 106, 112, 117-127, 143, 152, 155, 162-163, 168, 180-181, 198-199, 196-197, 204, 209, 211, 216, 289, 343, 443, 460-465, 472, 477, 489, 496-498, 503, 507, 509-514, 531, 535-536, 542-543, 546, 550, 558, 564, 580, 583, 591, 593, 605, 652, 657, 670, 672, 705  
 Epidemic 15, 34, 98, 434, 458, 489, 506-516, 525-526, 535-537, 541, 570, 605, 639, 645

Equivalent diameter 404  
*Escherichia coli* 109, 115, 662  
 Eutrophication 103  
 Evaluation 512, 536, 544, 550, 571-572, 574, 656-657  
 Evaporation 68, 70, 76, 89, 119, 179, 334, 371, 479, 586, 626-629, 672  
 Evapotranspiration 68-71, 179, 627, 672, 674  
 Excreta disposal 37, 458, 464-465, 546-549, 568, 576, 649, 652  
 Exit strategy 609  
 Exploitation flow, critical flow 211, 223, 226-227, 282-284, 293, 342, 434, 610  
 Explosives (wells) 122, 254  
 Faecal contamination 639, 642, 661, 681, 685, 705  
 Faecal risk 109, 310, 436, 442-443, 451, 459, 490  
 Faecal-oral 26-28, 98, 106, 114, 493, 546, 659, 661-662  
 Faecal-oral disease transmission 27-28, 106, 472, 493, 497, 546, 662-663  
 Feasibility study 101, 266, 310, 328, 384, 387, 551, 562, 626-627  
 Fee collection 590  
 Fence 9, 59, 102, 242, 286, 364, 421, 500, 521, 524, 586, 598, 627, 631-632, 707  
 Filter trench 442-443  
 Filtration 37, 82-83, 105, 119, 125, 129, 436, 443, 450-451, 479, 586, 632-633, 670  
     filtration speed 670  
 Fittings 37, 289, 298, 360, 395, 406-408, 417, 534  
 Flies 465-466, 471, 474, 478, 499  
 Flocculation 116, 435-439, 443-444, 451, 453, 587, 734  
 Flow 118, 132, 136, 140, 142, 172, 177, 179, 211-238, 243-244, 252-257, 266, 268-276, 282-284, 289-305, 325, 328, 331-350, 354, 363-372, 377-383, 386-404, 416-421, 434, 437, 451, 453, 463, 466, 475, 496-497, 499, 517, 610, 614-615, 627, 669-679  
 Flow measurement 297, 363  
 Flow rate 71-76, 81-87, 93-94, 211, 216-238, 451, 453, 480  
 Fluoride 27, 99-100, 103, 105, 107-108, 122, 127  
 Fluorine 94  
 Flies 28, 465-466, 471, 474, 476, 497-500, 508, 547, 550, 661, 663, 665, 707  
 Focus group 545, 560  
 Food hygiene 459, 507, 516, 531, 534, 542, 547, 550, 595, 628-629  
 Food security 641, 646-647, 655-658  
 Footbath 515, 521-530  
 Foot-pump 632  
 Forced flow 722  
 Foundations 374-375, 377, 737, 740, 745-746, 750, 768  
 Free-surface flow 670  
 Gender 20, 23, 31, 56, 461, 491, 545, 553, 558, 560, 594, 619  
 Geophysical & hydrogeophysical methodology 20, 31, 131, 136-140, 149, 158, 168, 170-175, 180-190, 194-195, 198, 206, 266, 306, 676, 691  
 GI pipe 415-416  
 Giardiasis 659, 661, 663  
 GIS (Geographical Information System) 20, 31, 136  
 Glued joint 407  
 Grab bucket 246, 255  
 Grain size 78, 255, 297-289, 300, 308-309, 733  
 Gravel pack 248-249, 252, 283-284, 289-305, 308-309, 312, 325  
 Gravity distribution 383, 387, 399, 422, 517, 521, 583, 590, 592, 598, 610  
 Gravity transmission 396, 398  
 Grease trap 476, 496, 524  
 Grey-water 37, 475, 477  
 Grouting 300-301, 312, 314, 707  
 Guideline values 121-122, 640  
 Guidelines 15, 24, 35, 52-53, 58, 95, 106-111, 119-120, 197, 273, 463, 595, 619, 640-642, 648, 657, 681-682  
 Handpump 24, 54, 179, 190, 212, 225, 241-243, 266-267, 274, 282, 284, 299, 306, 315, 325, 332, 353-354, 434, 451, 493, 532, 581, 583-584, 590, 596, 598, 627, 639, 647-648, 677, 682, 709  
 Hand-washing 462, 465, 521-526, 531, 534, 542, 557, 562, 622, 640  
 Hardness (water) 681  
 Hazen-Williams formula 81, 393  
 Head losses 190, 211-213, 218, 221-223, 227, 235, 272, 282, 300, 308, 310, 312, 334-344, 364, 388, 392-398, 437, 442, 521, 671, 724-726, 728  
     friction losses 395  
     linear head losses 221-223, 335, 393, 395, 724-726, 728  
     secondary head losses 335, 342, 395, 399, 728  
 Header tank 390, 392, 396, 398, 401-402  
 Health education 562, 661  
 Health risk 465, 473, 491, 497-498, 502-503, 543-547, 576, 582, 605, 465, 473, 491, 497-498, 502, 505, 543-544, 547, 576, 582, 605  
 Health-walk 545, 549  
 Helical rotary pump 358, 633  
 Helminth 27-28, 99, 106, 642, 659-661, 664  
 Hepatitis A 518, 659, 661-662  
 Hookworm 642, 661, 664  
 Hourly demand (water-distribution system) 368-369, 395  
 Household hygiene 13, 25-26, 35, 37, 44, 99, 102-103, 487, 491, 493, 532, 547, 549-550, 581, 598  
 HTH (High-Test Hypochlorite) 258, 313, 434, 447, 449, 514, 520, 523, 526, 537, 733  
 Humus 120, 483

- Hydraulic conductivity 81-82, 173, 211  
Hydraulic design 390  
Hydraulic head 81-82, 344  
Hydraulic pump 279, 287, 356, 711  
Hydrodynamic 83-85, 204, 211, 272, 310  
Hydro-geophysics 131, 136-137, 170, 180, 185, 188  
Hydrological balance 68, 93-94, 177, 179, 672  
Hygiene 11, 14-17, 20, 25-28, 34, 37-38, 48, 57, 60, 97-99, 102, 106, 108, 113, 130, 315, 639, 649, 652, 656-658  
    environmental 459-461, 465, 493, 497, 542, 546-549, 569, 573, 595, 606  
    facilitators 567-569, 591  
    facilities 37, 493, 549, 649, 656  
    kit 570, 572-573  
    personal 25, 27, 97, 459, 477, 495, 542, 573, 595, 656  
    practices 11, 14-15, 34, 102, 106, 113, 462, 465, 493, 497, 507, 512, 515, 530, 534, 536, 542, 544-545, 549-550, 557, 563, 568, 572, 589, 611, 619, 622, 651-652, 656  
    promotion 11, 17, 20, 28, 34, 37, 57, 60, 99, 102, 130, 458, 461-462, 489, 491, 493, 495, 511-512, 515, 531, 534, 536, 539, 541-574, 577, 581, 591, 622, 656-658  
    survey sampling 123-126, 129, 572, 639, 645, 682, 685  
    water points 11, 15, 621-622, 682, 685, 705, 707  
    water transport 380, 707  
Impact (project) 39, 47, 63, 461, 550, 562, 572  
Incinerator 501, 503, 522  
Incrustation 309-310, 681  
Indicators 9, 14, 24-25, 34-36, 46-49, 62, 103-109, 112-115, 175, 206, 364, 416, 551, 596, 615, 639, 641, 643-648, 681, 685  
Inductance 730  
Infiltration 76, 92, 94, 102, 105, 117, 130, 135-136, 179, 205, 242-243, 255, 257, 283-284, 364, 367, 372, 398, 417, 442, 463, 468, 477, 479-481, 497, 524, 627, 672, 674-675, 754  
Infiltration rate 488  
Insecticides 121, 483, 498-499, 524  
    deltamethrine 498-499, 524  
Inspection trap 402, 404  
Instantaneous flow 87, 216, 305, 349-350, 386  
Internal procedures 5-6, 48, 53, 57, 61-62  
Intervention criteria 7, 13-15, 19, 22, 24, 43, 57, 62, 137, 254, 458, 461-462, 470, 489, 499, 510-513, 535-537, 542-543, 549, 568-569, 582, 609, 614-615, 655  
Interviews 31-33, 53, 61, 545, 549-553, 560, 564, 570  
Iron 95, 119, 122, 309, 358, 370, 393, 412, 442, 446, 451, 613, 734  
Jacob's method 190, 200, 212, 215-218, 221-224, 230  
Jar test 436, 444, 448  
Jerrycan 483, 521, 531, 612, 707  
Job description 55-56, 526, 530, 655-658  
KAP survey (Knowledge Attitudes and Practices) 31, 34, 48, 461, 550, 553, 572, 574  
Key-informant 31, 58, 550  
Laminar regime (water flow) 72, 76, 82, 161, 221, 669-670, 722, 726  
Latrines 24, 28, 37, 44, 47, 106, 112, 120, 130, 460-467, 472-493, 517, 522-527, 531-532, 546-550, 557, 562, 568, 606, 621-622, 640, 649, 652, 656, 705-706  
    composting 464, 482-488  
    contamination 468, 473, 488-489  
    desludging 473, 477, 479, 621  
    dry latrine 465, 474, 479, 488  
    LASF 483-485  
    lining 468, 470, 480  
    pour-flush 474, 479, 482, 488, 640  
    promotion 466  
    simple pit 464-466, 472  
    slab 462, 465, 467-472, 477, 479, 483, 486, 491, 534  
    superstructure 462, 465-468, 472, 475, 479, 486  
    vault 486-488  
    VIP (Ventilated Improved Pit) 462, 464, 466, 471-472, 475, 482  
    water point 462-465, 474, 488, 490, 493  
Laundry area 37, 60, 372, 493, 495-496, 523  
Layout plan 384, 386, 606  
Leptospirosis 659, 662  
Livestock 3, 11, 15, 17, 34-35, 97, 106, 328, 585, 614-616, 629, 640-641, 647  
Local authorities 15, 19, 31-35, 49, 55, 57, 61, 135, 305, 418, 510, 530, 534, 537, 545, 550, 582, 586-589, 593-595, 615, 657-658  
Logical Framework Matrix (LFM) 45-49  
Logical Framework Analysis (LFA) 22, 39, 45-46  
Long-term intervention 8-9, 18, 23, 63, 99-100, 103, 108, 121, 127, 331, 360, 544  
Low-cost solution 359-360, 576, 580, 657-658  
Magnesium 118-119, 681  
Magnetic field 160-161, 167-170, 175, 177, 196, 730  
Maintenance 6, 18-19, 37, 48, 55-56, 60, 99, 102-103, 106, 197, 243, 275, 279, 305, 307, 314, 319, 328, 331, 343, 347, 351, 359-360, 397, 401, 417, 434, 441, 451, 461-462, 465, 472, 479, 489-490, 497, 502, 527-529, 571, 576-577, 580, 583-598, 610, 619, 621, 625, 629, 632, 656-657  
Major parameters (water quality) 100, 102, 106, 621  
Malaria 11, 15, 103, 105, 497, 547, 572-574, 605, 660-661  
Malnutrition 9, 17, 458, 541, 619, 622, 645-646  
Manganese 95, 119, 122, 309, 446

Masonry 256-258, 364, 374, 378, 380, 397, 403-404, 414-417, 486, 595, 735-737, 753-754  
 Mass flow 730  
 Mass media 565, 567  
 Meteorological data 20, 678  
 Microbiological contamination 94, 96-99, 102-103, 106, 112, 441, 651  
 Microbiological water quality 99-102, 105, 127-128, 642  
 Mineralisation 91, 104, 117, 136, 140, 158, 180, 188, 196  
 Mitigation (disaster) 8  
 Moment of a force 168-169, 171, 192, 216, 729, 761-765, 770-772  
 Monitoring 16-17, 23-24, 37, 45-62, 84, 94-96, 99-106, 116, 177, 211, 236-238, 292, 305, 314, 442, 488, 513-514, 532, 535-536, 545, 568, 571-572, 587, 593, 596, 616-618, 621-622, 657, 676, 705  
 Moody's diagram 723, 726  
 Morbidity 28, 34, 48, 458, 645  
 Mortality 14, 17, 28, 34, 506, 526, 535, 542, 615, 644  
 Mortar 251, 256, 308, 313, 328, 378, 629, 735-741  
 Mosquitoes 28, 103, 105, 474, 478, 486, 497, 547, 550, 661, 663-665  
 Motorised electrical pump 584, 647  
 Motorised pump 283, 325, 332, 339-340, 346, 436, 677, 682  
 Mud pit 286-287, 629, 631  
 Natural disaster 4-6, 8, 15, 34, 108, 582, 609  
 ND (nominal diameter) 716  
 Needs assessment 15, 25, 544-545, 572, 593, 651  
 Nitrates 106, 117, 119-120, 123-124  
 Nitrites 119-120  
 Nomogram 215-216, 691, 696-699, 724-726, 728  
 NP (nominal pressure) 390, 392, 405  
 Nutritional status 35, 49, 645-646  
 Objective tree 42, 49  
 Off-plot sanitation system 464  
 On-plot sanitation system 464-465  
 Open circuit 368  
 Open storage 371, 532  
 Open well 59, 108, 130, 190, 581, 583, 598, 639, 648, 682  
 Organigram 55-56, 525  
 Organochlorides 103, 106, 118  
 Organoleptic parameters 99  
 ORS (Oral Rehydration Salts) 508, 514-519, 522-524, 527, 531, 537  
 Outbreaks (disease) 28, 99, 102, 458, 507, 509-510, 534, 536, 541, 543, 558, 570, 619  
 Overflow 69, 363-364, 367, 370, 380, 402, 404, 497, 626-629  
 Over-pumping 223, 308  
 Oxfam-type tank 436, 451  
 Oxidability 681  
 Parasites 28, 103-105, 458  
 Pastoralism 616  
 Pasture 615, 632, 642  
     over-grazing 632  
 Pathogen 11, 27-28, 98, 103-109, 114-115, 118, 130, 441, 443, 446, 450, 459, 461, 473-474, 479, 484, 547, 571, 662-665, 659-661  
 PE pipe 409  
 Peri-urban area 11, 15, 458, 581-582, 587, 610  
 Permeability 81, 84, 86, 90-93, 132, 162, 173-175, 199, 205-208, 236, 252, 301, 308, 524, 627  
 Pesticides 95, 103-106, 476, 648  
 pH 103, 106, 115-118, 123-127, 237, 439, 442-444, 446, 449, 451, 463, 621, 681, 734  
 Photo-interpretation 134, 154, 186  
 Physical-chemical parameters 86, 307, 475  
 Piezometer 172, 200, 212-218, 233, 235-236, 266, 719  
 Piezometric 81-85, 89-94, 177, 216, 222, 224, 236, 364, 367, 399, 463, 671, 676  
 Piezometry 83, 94, 675  
 Pillars (construction) 737, 740, 746, 759, 763-766  
 Pipes 112, 118, 122, 124, 130, 159, 175, 207, 237, 267-268, 275, 277, 287, 291, 294-295, 300, 308, 310, 314, 334, 338, 341, 361, 367, 378, 389-417, 421, 434, 436-437, 475, 521, 593-594, 648, 681, 710, 724-726, 728  
 Pipe repair 412  
 Pipe route 388, 421  
 Pipe-cutter 406  
 Piston pump 356  
 Pistoning 304, 312  
 Planning 8, 21-24, 39, 44-45, 53-55, 62, 420, 439, 461, 495, 511, 515, 545, 547, 559-561, 576, 606, 609-610, 640-641, 657, 706  
 Plug 271, 295, 297, 300-301, 305, 314, 325, 378, 380, 527, 532  
 Pneumatic water pump 346-347  
 Policy 6, 9, 22, 24, 579, 592-593  
 Poliomyelitis 659, 661-662  
 Pollution 70, 93-96, 100-109, 112-117, 120, 123, 152, 188, 204, 241-245, 258, 266, 284, 297, 301, 309, 325, 364, 436, 442, 446, 450-451, 463, 532, 625, 627, 681, 705-707  
     bacterial 463, 625  
     domestic 27, 106, 120, 661  
     faecal 11, 16, 26-28, 98-99, 102-109, 114-115, 120, 125, 130, 310, 364, 436, 442, 451, 490, 639, 659, 661-663, 681, 685, 705  
     geological 106  
     migration of pollution 705  
     natural 94-95, 100, 105-106, 122  
 Polycol 267, 271, 289, 710, 717, 719  
 Polyphosphates 313, 681  
 Ponds 69-70, 104-105, 371, 585-586, 614, 617, 625-633, 642, 707

- impluvium ponds 625-626, 632, 635
- run-off ponds 629, 635
- Pool tester 99, 127
- Porosity 78-80, 86, 92-93, 131, 137, 170, 172, 175, 178, 205-206, 213, 300, 304, 463, 676
  - kinematic 78, 172, 175
- Porous environment 81-82, 216, 669-670
- Post-crisis 6, 8
- Potassium 106, 116, 119-121, 681
- Pouring (cement) 248, 375, 377, 470, 750
- PRA (Participatory Rural Appraisal) 31, 33, 594
- Pre-casing 284, 296
- Precipitation 68, 106, 119, 121, 123-124, 299, 309, 451, 625, 627, 672, 675-676, 679
- Prefabricated block 257, 403, 489, 737
- Preliminary appraisal 40, 94, 132, 135-136, 183, 266, 309, 363, 388, 544-545, 547
- Pressure classes (pipes) 37, 390, 405
- Pressure
  - dynamic 403
  - residual 295, 335, 340, 392, 397-399, 437
  - static 390-392
- Pre-treatment of water 99, 442, 479, 585
- Private management (water supply) 35, 576-586, 593, 614-615, 629
- Problem analysis 23, 39-40, 292, 315, 388
- Problem tree 40-42
- Project 460-461, 465, 472, 483-484, 526, 544, 553, 559, 567-569, 572, 574, 576, 578, 580, 593-594, 596, 629, 655-658
  - identification 17, 23-25, 34, 38-40, 47, 54, 384
  - design 7, 23-24, 39-40, 49, 56, 59-63, 383-390, 395, 401-402, 418, 434
  - effectiveness 16, 55, 62, 98, 115, 377, 442
  - efficiency 55, 62, 262, 310, 312
  - formulation 23, 57
  - impact 39, 62-63
  - implementation 8-9, 16-23, 47, 49, 53-56, 60-62, 98, 130, 259, 266, 434-435
  - project cycle 16, 19, 22-23, 39, 59-62, 544
  - project management 21-22, 60, 62, 434, 439
  - sustainability 16-17, 23-24, 39, 43, 55, 60-63, 462, 502, 567-568, 576, 580, 583, 587, 594-595, 629
  - replicability 63
- Protection perimeter 367, 378, 705-707
- Protozoa 27, 99, 106, 109, 115, 663
- Protozoa cysts 99
- Public health 3, 11, 14, 16, 98-99, 119, 488, 502, 529, 542, 582, 705
- Public management (water supply) 385, 477, 577-580, 629
- Pulley 241, 243, 246, 257, 352, 360, 583
- Pump mechanic 584
- Pumping 76-81, 85, 87, 93, 136, 170-174, 177, 190, 194, 196, 199, 202-203, 211-238, 251, 253-255, 266, 276, 286, 289, 293, 297, 299, 301-315, 325, 328, 331-334, 338, 346-354, 358-360, 370, 384, 434, 436-438, 442, 585-586, 610, 614-615, 632, 677, 701-702, 718
- Pumps 473, 583-587, 593-594, 598, 610, 621, 632-633, 647, 679, 709, 711
  - absorbed power 334, 337, 344-345
  - centrifugal pump 332-333, 340, 350
  - generator 236, 255, 343-346, 434, 450, 691
  - head losses 310, 334-335, 338-339, 341-344, 437
  - membrane dewatering pump 347
  - NPSH (Net Positive Suction Head) 334-335
  - performance 344, 352, 354
  - pump curve 334-341, 369
  - pumps in parallel 339-340, 350
  - pumps in series 338-342, 348, 350
  - rotational speed 269-270, 337-338, 352
  - rotor speed suction head 337, 348
  - starting current 344-346
  - throttling delivery pipe 338
  - TMH (Total Manometric Head) 334-350
  - voltage drop 345
  - working point 337-340
- Pumping hydraulics 334
- PVC pipe 237, 359, 364, 407, 416, 437
- Quality standards 97-98, 106, 108, 111, 129
- Questionnaires 31, 33
- Quick-fit connection 410
- Rainfall measurement 69-71, 91, 177, 190, 215, 370, 627, 672, 674
- Rainwater harvesting 68-69, 103, 585, 625, 683
- Rainwater drainage 524, 606, 626
- Rainwater tank 68-69, 103
- Rainwater-catchment tank 370
- Rapid appraisal 33, 38, 309-310, 387-388, 442, 463, 491, 493, 514, 536, 549, 582
- Rapid assessment 38
- Rapid sand filter 450-451
- Raw-water 100, 190, 437, 442, 621, 627, 734
- Recharge 83, 93-94, 177, 205, 213, 215, 218, 235-236, 614, 617, 672, 675-678
- Recovery (water level) 7, 190, 192, 200, 215, 218-221, 225, 228-233, 235, 237
- Reducer 395
- Refuse collection 500, 502, 549, 562, 649
- Refuse management 37, 576, 652
- Regulating valve 226, 401, 417
- Rehabilitation 7-11, 54, 102, 130, 212, 222, 255-256, 307-314, 485-486, 532, 582, 597, 606, 609
- Reinforcement 248, 250-255, 328, 374-377, 470, 711, 735-736, 740-741, 744-754, 757-768, 772
- Reinforcement bar 744, 751, 757, 764, 772
- Relapsing fever 659, 662
- Relevance (project) 16-17, 23, 39, 43, 49, 61-63, 108, 309-310
- Research techniques 35, 132, 136, 168, 181, 547-550



- Resistivity 80, 137-138, 140-149, 152-168, 170, 175, 180-186, 189, 194, 196, 198-199, 203, 206, 208, 691, 694-695, 730  
 apparent 140, 142, 145, 147, 149, 152, 154, 161-165, 167-168
- Resistivity of rocks 80, 140, 189
- Resistivity meter 143, 145-146, 152, 155, 158, 691
- Resource schedule 237
- Retaining wall 364, 737, 740, 749, 753-754, 759, 769-771
- Reynolds number 669-670, 721-722
- Risk management 8, 35, 685
- Rivers 415, 435-437, 442, 587, 614, 677
- Rope-and-washer-pump 359-360, 598
- Rotary drilling 159, 267, 269-276, 284, 286, 289-300, 312, 319, 322, 332, 709-712, 719
- Rotary pump 633
- Rotary speed 352
- Roughness 393, 722, 726  
 relative 722, 726
- RRA (Rapid Rural Appraisal) 33
- Rubber joint 407
- Run-off 70-71, 496, 500, 585, 587, 625-629, 633, 672, 677, 705
- Run-off catchment 371
- Safe water 1, 62, 243, 495, 542, 547, 559, 569, 587, 622
- Salmonella 104, 662
- Sampling 114, 123-126, 128-129, 550-552, 686-688
- Sanitary barrier 512, 521, 524
- Sanitary environment 6, 9, 11, 14, 16, 35, 474, 486, 502, 510, 517, 521, 530-532, 534, 536, 542, 575, 582, 625
- Sanitary inspection 39, 102, 112-114, 656, 682
- Sanitary post 526
- Sanitary risk 458, 489-490, 493, 542, 544-547, 559, 619-620, 458, 489-490, 493, 542, 544, 546-547, 559, 619, 622
- Sanitary survey 15, 31, 39, 102, 109, 112-114, 511-512, 514, 682, 685
- Sanitation 4, 8, 16, 24, 35, 37, 44, 108, 190, 458, 639, 646-651, 655-659, 685
- Sanitation promotion 11, 17, 20, 28, 34, 37, 57-58, 99, 102, 130, 458-503
- Satellite images 35, 134-136
- Scabies 27
- Schistosomiasis 27, 659, 661, 664
- Schlumberger 696  
 equipment 142, 146, 148, 185, 191-194, 196
- School sanitation 111, 196, 462, 508, 567-568, 570
- Screen 197, 221, 224, 226-227, 282-284, 297-314, 325, 442-443, 716, 718-719
- Scrub typhus 15
- Sedimentation 20, 70, 91, 99, 289, 435-439, 443-444, 451, 476, 478, 585, 611, 621, 629, 631, 642
- Septic tank 28, 120, 464, 468, 474-480, 547, 705
- Settling casing 717
- Sewage 28, 116-117, 120, 123, 474, 479, 531
- Sewerage 37, 459, 464, 477, 479, 586
- SFC (Supplementary Feeding Center) 619
- Shaduf 244, 325
- Shear stress 758-759
- Shelters 24, 517, 524, 606
- Shigellosis 506, 659, 661-662
- Shower 37, 290, 493, 496, 516-517, 522-527, 530, 606, 649
- Shrinkage 736-737, 740, 742
- Shroud (boreholes) 283, 299
- Shuttering 245, 247-248, 328, 377, 741-742, 772-773
- Signs of water 78, 293, 296, 305
- Sika 255
- Sikalatex 742
- Simple pit latrines 464-466, 472
- Slab 68, 119, 242, 252, 288, 301, 326, 372, 374-375, 377, 418, 740-741, 745-749, 758-759, 762-764, 767-768  
 borehole 119  
 floor 745  
 latrine 462, 465, 467-472, 477, 479, 483, 486, 491, 534  
 shower 522  
 well 119, 326
- Slingram 137, 160, 165
- Slow sand filter 451
- Sludge 28, 473-475, 477-479
- Sludge pump 479
- Soakaway 242, 468, 478-485, 521-524
- Soap 37, 124, 242, 476, 524, 546, 564, 570, 573-574, 649, 652
- Socket 406-407
- Sodium 119-121, 532, 681, 733
- Solar energy 68, 343-344, 347-351, 485, 585
- Solar pump 347-351, 585, 647
- Solar radiation (HSP) 349-350, 672, 679
- Span 415-416, 746-748, 759  
 beams 746-747
- Spare parts 37, 58, 580, 583-584, 589-593, 596, 621, 649
- Specific intervention 534, 553, 572, 603-633
- Specific objective 46-49, 62, 205
- Specific yield 80, 83, 88, 173-174, 200, 209, 212
- Sphere Project 9, 24, 111
- Spring 54, 68, 76, 83-85, 89-90, 93, 100, 106, 205, 363-369, 372, 374, 378, 395-396, 398, 421, 495, 583, 585-586, 592, 647, 677, 683, 705, 707, 711
- Spring catchment 363-369, 372, 384, 387, 390, 395-398, 420, 422
- Sprayer 499, 515, 527-532
- Staff management 53, 55, 57-58, 657
- Stakeholder 19-23, 29, 39-40, 46, 53-55, 60-61, 589, 593

Static profile 390, 397  
 Static-head profile 390  
 Steel reinforcement 247, 251, 255, 422, 470, 735, 740, 743-744, 764, 766-767, 772  
 Stock solution 444, 447-449, 532  
 Stop cock 404, 417  
 Stop valve 401-402  
 Storage 35, 37, 58, 68-70, 77, 80-81, 87-93, 99, 102-103, 131, 136, 177, 213, 254, 287, 371, 436, 443, 446, 484, 487, 499, 503, 520-523, 530, 542, 547, 550, 559, 570-573, 584, 586, 611, 652, 707, 734  
 Storage coefficient 79-80, 87, 131, 173-174, 200, 211-213, 216, 676  
 Storage tank 68, 99, 103, 325, 363, 368, 395, 397, 401, 404, 434-438, 451, 517, 521, 610-613, 632  
 Storativity 78, 80, 88, 168, 170-177, 199-203, 211-212, 235  
 Strategy 8, 22, 39, 43-46, 49, 53, 56-57, 63, 98, 140, 495, 512, 514, 536, 576, 609  
 Strategy analysis 43-44  
 Submersible pump 212, 222, 226, 254, 266, 274, 282, 284, 335, 338, 342, 346, 434, 436, 647  
 Substratum 76, 83, 85, 90, 181-183, 198, 201, 367  
 Suction head 237, 334-335, 342, 437  
 Suction pump 267, 334-335, 353-356, 361, 443, 598, 633  
 Sulphate 105, 116-117, 119, 121, 123-124, 436, 442-445, 453, 587, 598, 734  
 Surface motorised pump 334-335, 340, 346, 350, 436, 584  
 Surface water 67-68, 70, 76, 94, 101-104, 107, 117, 136, 179, 199, 242, 245, 257, 284, 309, 418, 436, 442, 463, 470, 614, 625, 627, 675-676, 706-707  
 Survey 306, 384, 387-388, 397-398, 507, 511-512, 545, 549-553, 557-560, 572-574, 593, 616, 639, 645, 647, 657, 676, 682, 685  
 Sustainability 8, 12, 16-18, 23-24, 39, 43, 55-56, 60, 62-63, 99-100, 283, 462, 502, 567-568, 575-576, 580-583, 585, 587, 594-595, 629, 631  
 System valve plan 401  
 Taboos 18-19, 543-545  
 Talbot self-closing tap 385, 398, 417, 587, 611-612, 647  
 Tank 28, 68-69, 103, 120, 286, 325, 348, 354, 359, 363-364, 367-371, 390-404, 409-410, 417, 422, 434-438, 444, 449, 451, 453, 464, 468, 474-480, 489, 517, 520-523, 547, 583, 585, 587, 595, 610-615, 627, 632, 705, 728, 737, 742, 745-746, 749, 751-753, 759-763, 765-768, 772  
 Tanker 410, 473, 479, 516-517, 610-614, 647, 652  
 Tapeworm 28, 661, 664  
 Tapping saddle clamp 328  
 Taps 37, 99, 368, 386-388, 395, 398, 405, 409, 417-418, 434, 449, 493, 521, 523, 585, 587, 611-614, 647  
 Tapstands 385-388, 397, 399, 401, 410, 413, 417-418, 421, 434-435, 587, 595, 610-614, 633, 745, 754  
 Target area 181, 545, 549, 559  
 Target audience 547, 562-565, 567-569  
 Target population 15-16, 23, 31-32, 48, 102, 544, 547, 551-552, 559, 564, 567, 570, 572-574  
 Taste (water) 99, 119-122, 309-310, 648, 681  
 TDEM (Time Domain Electromagnetic) 137-138, 160, 166-168, 180-186, 189-194, 197-199  
 Temperature of water 81, 86, 105-106, 117-118, 123-126, 135, 140, 158, 190, 237, 405, 627  
 Temperature data 69, 658, 670, 672, 678, 721  
 Tensile stress 740, 758  
 TFC (Therapeutic Feeding Centre) 619, 622  
 Theis 200, 215-216, 218, 221, 225, 231, 235  
 Thermal capacity 730  
 Thermal flux 730  
 Thiessen's method 70, 672  
 Thrust block 416  
 TMH (Total Manometric Head) 334-350  
 Toe 242, 381, 418  
 Toilets 464-465, 475, 530-531, 546-547, 622, 640-641, 652-653, 661  
 Total dissolved solids 116-117, 640  
 Topography 70, 85, 89, 134, 384, 387, 389  
   Abney level 389  
   altimeter 31, 387  
   clinometer 389  
   theodolite 388-389  
 Toxicity 94, 96, 107-108, 116, 681  
 Training 11, 18-19, 46, 48-49, 54-57, 59, 99, 254, 305, 347, 462, 473, 484, 488, 503, 513-515, 525, 529-536, 559-560, 567-569, 576, 579-589, 591-598, 621, 657-658  
 Transmission line 49, 374  
 Transmission route 26-27, 98, 546, 571  
 Transmissivity 81-83, 85, 87, 105, 132, 168, 170, 172-175, 190-196, 200-208, 211-218, 221, 225, 231-235  
 Treadle pump 360-361  
 Truck 276, 279, 287, 516, 582, 587, 594, 609-618, 709-711, 717  
 Turbidity 103-106, 118, 122, 127, 283, 310, 331, 364, 436-437, 442-443, 446, 450-453, 587, 621, 639, 649  
 Turbulence 74, 478, 669  
 Turbulent regime (water flow) 73, 82, 221, 223, 669-670, 722, 726  
 Turc's formula 627  
 Typhus 15, 458, 605, 659, 663  
 Unclogging 307, 312  
 Union 417  
 Upstream approach (hydrology) 94, 672, 678, 705  
 Urban area 3, 11, 15, 34, 109, 199, 343, 424, 458, 473, 487, 497, 501-502, 514, 531, 534, 576, 581-582, 609



- Useful precipitation 76, 672, 675-676
- User-fees 37, 598
- Valves 237, 295, 335, 338, 354, 393, 395, 401, 405, 416-417, 589
- Vectors 15, 27-28, 38, 103, 459, 493, 496, 498, 508, 547, 652
- Vector control 459, 497, 547, 652
- Vector-breeding site 652-653
- Vendors (water) 582, 592
- Venturi 289, 453, 466
- Vibrator rod 247
- Vibrio cholerae* 507-510, 532, 662
- Video 565, 567, 574
- VIP latrines 462, 464-466, 471-472, 475, 482
- Virus 27, 99, 106, 109, 115, 503, 659-663
- Viscosity 81, 140, 271, 669-670, 721, 726, 730  
dynamic 81, 721, 730  
kinematic 81, 669-670, 721, 730
- Vitalism 14
- VLF (Very Low Frequency) 137, 160-163, 165
- Voltage potential 730
- Vulnerability 4, 6, 8-11, 13-15, 20, 59, 98, 112-113, 132, 541, 547, 582, 610, 629, 655-656, 685, 705
- Vulnerable people 15-16, 26, 34, 140, 461-462, 483, 489, 547, 569-570, 577, 579-581, 587, 619, 651, 655-656
- Washing area 372, 374, 377, 379-380, 493, 496, 521, 523-524, 526, 549, 582, 606, 622, 649, 719, 745
- Wastewater 242, 421, 463, 475-479, 496-497, 517, 524, 530, 576, 642
- Water  
analysis 31, 37, 94, 97, 123, 129, 559, 598, 620-621, 648, 681-689  
balance 94, 672, 676-678  
collection 11, 71, 379, 395, 486, 542, 547, 549-550, 570-573, 585, 594, 612, 629, 632, 651-652  
committee 19-20, 102, 112, 511, 578, 581-596, 616-617  
cycle 67-68, 93  
demand 3, 24-25, 54, 243, 363, 368-370, 385, 442, 451, 575-576, 614, 628  
handling 37, 542, 546, 550, 559, 570, 577  
layer 69, 72-73, 78, 80, 403  
management 11, 20-23, 37, 99, 204, 557-560, 575-601, 610, 612, 617, 625, 649, 656  
policy 9  
quality 97-98, 106, 108, 111, 129, 242, 266, 307, 364, 439, 639-642, 648, 656, 681-689, 705, 707  
resource 575-577, 585, 593, 598, 609-610, 613-616  
treatment 20, 37, 99, 101, 112, 114-116, 119, 266, 312-313, 346, 370, 434-439, 441-452, 477, 485, 499, 532, 559, 581, 586-587, 610, 621, 625, 642, 645, 681, 733-734  
trucking 37, 531, 587, 609-618, 647, 684
- Water and sanitation-related diseases 3, 9, 11, 15, 26-28, 34-35, 98, 459, 461, 496, 541-545, 591, 595, 651, 659-665, 648, 651, 659-665
- Water-borne diseases 496, 659, 685
- Water-washed diseases 493, 659
- Weir 72-73
- Wells 47, 70, 83-84, 90, 93-94, 100, 108, 119, 130, 135-136, 140, 178, 190, 212, 215, 218, 222, 225, 235-236, 241-263, 266, 275, 325-329, 346, 359, 511, 517, 531-532, 535, 570, 581-583, 598, 614-615, 672, 705, 707, 709  
anchorage 247-253, 375, 388, 744-745  
bailer 251, 253, 255, 267, 304, 312, 328  
bottom-up lining 247, 326  
concrete ring 249, 251-252, 442, 468, 499, 740, 773  
cutting ring 251-252, 773  
digging 245-262, 264, 275, 286, 325, 327-328, 346-347, 388, 420-421, 594, 709  
explosives 254  
filtering concrete ring 249  
gravel pack 249, 252, 283-284, 298-305, 308-312, 325, 717, 719  
independent intake 244-245, 248, 251-252, 255, 257-258  
jackhammer 247, 254  
lining 242, 244-248, 250-258, 326, 328, 732, 773  
over-digging  
perforated ring 248  
reinforcement 711, 735  
rings 244-245, 248-252, 255, 258, 267, 271, 326, 354, 468, 489, 740, 773  
ring mould 257, 739, 742, 773  
shuttering 245, 247-248, 328, 377, 741-742, 772-773  
surface anchorage 248, 250  
surging 253, 304, 312  
top-down lining 247-248, 255, 257  
wellhead 242-243
- Wenner 142-143, 148, 152, 155-156, 158, 165, 208
- Whipworm 661, 664
- WHO (World Health Organization) 3, 11, 24, 95, 98, 108-109, 111-112, 115-122, 443, 445, 458, 463, 507, 511, 531, 536, 552
- Winch 241, 243-244, 251, 255, 274
- Wind pump 584, 647
- Withdrawals (hydrology) 19, 93, 159, 314, 677
- Work-plan 49, 51-52, 54

# Bibliography

## General water and sanitation programmes (recommended references)

- Abdallah S, Burnham G, eds. (2000). *Public health guide for emergencies*. IFRC/The Johns Hopkins University, Baltimore, MD.
- Adams J (1999). *Managing water supply and sanitation in Emergencies*. OXFAM, Oxford.
- Cairncross S, Feachem R (1993). *Environmental health engineering in the tropics*. John Wiley & Sons, Chichester.
- Davis J, Lambert R (2002). *Engineering in emergencies: a practical guide for relief workers*. 2<sup>nd</sup> ed. RedR/IT Publications, London.
- DFID-WELL (1998). *Guidance manual on water supply and sanitation programmes*. DFID-WELL, London.
- Harvey P, Baghri S, Reed RA (2002). *Emergency sanitation: assessment and programme design*. WEDC, Loughborough.
- House S, Reed RA (1997). *Emergency water sources: guidelines for selection and treatment*. WEDC, Loughborough.
- Sphere Project (2004). *Humanitarian charter and minimum standards in disaster relief*. 2004 ed. Sphere Project, Geneva.
- UNHCR (1999). *Handbook for emergencies*. 2<sup>nd</sup> ed. UNHCR, Geneva.
- WHO (2003). *Guidelines for drinking-water quality*. WHO, Geneva.
- Wisner B, Adams J (2002). *Environmental health in emergencies and disasters: a practical guide*. WHO, Geneva.

## Programme development

- ALNAP (2003). *Humanitarian action: improving monitoring to enhance accountability and learning*. Annual Review. ALNAP, London.
- Billig P, Bendahmane D, Swindale A (1999) *Water and sanitation indicators measurement guide*. Food and Nutrition Technical Assistance Project, USAID, Washington, DC.
- Brikké F, Rojas J (2002). *Key factors for sustainable cost recovery in the context of community managed water supply*. IRC International Water and Sanitation Centre, The Hague.
- Cairncross S, Saywell D (2004). *Measuring the health impact of water and sanitation*. WELL website.
- Clasen TF, Cairncross S (2004). Household water management refining the dominant paradigm. *Tropical Medicine and International Health*, 9(2):187-191.
- DFID (1997). *Guidelines for Humanitarian Project Proposals and Reporting*. Department for International Development, London.
- Eade D, Williams S (2000). *The Oxfam Handbook of development and relief*. OXFAM, Oxford.
- European Commission (1999) *Project cycle management: training handbook*. European Commission, Brussels.
- European Commission (1998). *Towards sustainable water resources management: a strategic approach*. European Commission, Brussels.
- European Commission (2004). *Aid delivery methods: Vol. 1, project cycle management guidelines*. European Commission, Brussels.

- FAO (2004). *The state of food insecurity in the world*. FAO, Rome.
- Gasper D (1999). *El Enfoque del Marco Lógico más allá de los proyectos. El seguimiento y la evaluación de la ayuda humanitaria en emergencias complejas*. Revista Española de Desarrollo y Cooperación, No. 4, IUUC.
- OECD (1999). *Guidance for evaluation of humanitarian assistance in complex emergencies*. OECD, Paris.
- Prüss A et al. (2002). Estimating the burden of disease from water, sanitation and hygiene at a global level. *Environmental Health Perspectives*, 110(5).
- Scanlon J, Cassar A, Nemes N (2004). *Water as a human right?* IUCN, Bonn.
- United Nations Committee on Economic, Social and Cultural Rights (2002). *The Right to Water*. Articles 11 and 12 of the International Covenant on Economic and Cultural Rights. CESCR General Comment 15, 26 November 2002, U. N. Doc. E/C.12/2002/11.
- World Bank (2004). *Public and private sector roles in water supply and sanitation*. World Bank, Washington, DC.

## Water resources

- Appelo CAJ et al. (1996). *Geochemistry, groundwater and pollution*. A.A. Balkema, Rotterdam.
- Beauce A et al. (1996). Une nouvelle méthode géophysique pour les études hydro-géologiques : l'application de la résonance magnétique nucléaire. *Hydro-géologie* 1:71-77.
- Brassington R (1998). *Field hydrogeology*. 2nd ed. John Wiley & Sons, New York–Toronto.
- BRGM (1992). *L'eau des granites, une ressource vitale, un facteur nouveau de développement. Summary of Exploitation des eaux souterraines en zone de socle au Burkina Faso 1984-1991*. Report R33576. BRGM/AQUATER Orléans.
- Caron JM et al. (1995). *Comprendre et enseigner la planète terre*. 3<sup>rd</sup> ed. Ophrys, Paris.
- Castany G (1982). *Principes et méthodes de l'hydrogéologie*. Dunod, Paris.
- Castany G (1982). *Principes et méthodes de l'hydrogéologie*. Bordas, Paris.
- Chapellier D (1987). *Diagraphies appliquées à l'hydrologie*. Lavoisier, Paris.
- CIEH and BURGEAP (1988). *Essais de débit simplifiés sur forages d'hydraulique villageois*. BURGEAP. Paris.
- D Gaujous (1995). *La pollution dans les milieux aquatiques*. Lavoisier, Paris.
- De Marsily G (1986). *Quantitative hydrogeology, groundwater hydrology for engineers*. Academic Press, London.
- De Marsily G (1986). *Quantitative hydrogeology*. Academic Press, London.
- Desclôître M (1998). *Les sondages électromagnétiques en domaine temporel (TDEM): application à la prospection d'aquifères sur les volcans de Fogo et du Piton de la Fournaise*. Doctoral thesis. Université Pierre-et-Marie-Curie (Paris VI), Paris.
- Fetter CW (1994). *Applied hydrogeology*. 3<sup>rd</sup> ed. Library of Congress, Wiley, New York.
- Forkasiewicz J (1972). *Interprétation des données de pompage d'essai pour l'évaluation des paramètres des aquifères*. 72 SGN 273 AME. BRGM, Orléans.
- Fourcassié P, Vouillamoz J-M (2000). *Apport de la géophysique à l'implantation de forages d'eau au Honduras, département de Choluteca*. ACF, Paris.
- Genetier B (1984). *La pratique des pompages d'essai en hydrogéologie*. Manuels & méthodes (No 9). BRGM, Orléans.
- House S, Reed RA (1997). *Emergency water sources: guidelines for selection and treatment*. WEDC, Loughborough.
- Howard AG (2002). *Water quality surveillance – a practical guide*. WEDC, Loughborough.
- Kruseman GP, de Ridder, NA (2000). *Analysis and evaluation of pumping test data*. ILRI, Wageningen.

- Ball P (2001). *Drilled Wells*. SKAT, St. Gallen.
- BURGEAP (1980). *La construction des puits en Afrique tropicale*. 2<sup>nd</sup> ed. Ministère de la coopération et du développement, Paris.
- Carlier M (1986). *Hydraulique générale et appliquée*. Eyrolles, Paris.
- Degrémont Y (1989). *Mémento technique de l'eau*. 9th ed. Lavoisier, Paris.
- Jordan DT (1980). *A handbook of gravity-flow water supply*. IT Publications, London.
- Lencastre A. (1995). *Hydraulique générale*. Safege, Eyrolles Paris.
- Mabilhot A (1988). *Le forage d'eau, guide pratique*. Johnson Filtration Systems, Naintre.
- OXFAM (1998). *Water treatment in Emergencies*. OXFAM, Oxford.
- Pacey A et al. (1986). *Rainwater harvesting: the collection of rainfall and runoff in rural areas*. IT Publications, London.
- Pacey A, Cullis A (1986). *Rainwater harvesting: the collection of rainfall and runoff in rural areas*. IT Publications, London.
- Raymond R (1995). *Drilling for water: a practical manual*. 2<sup>nd</sup> ed. Avebury, Aldershot.
- Schultz CR, Okun DA (1983). *Surface water treatment for communities in developing countries*. IT Publications, London /John Wiley & Sons, New York.
- SOGREAH (1985). *Manuel du technicien du génie rural*. Ministère des relations extérieures, coopération et développement. La documentation française, Paris.
- Watt SB (1978). *Ferrocement water tanks and their construction*. IT Publications, London.

## Sanitation

- Adams J (1999). *Managing water supply and sanitation in emergencies*. OXFAM, Oxford.
- Agencia Sueca de Cooperación Internacional para el Desarrollo / Fundacion Friedrich Ebert-México (1999). *Saneamiento ecológico*.
- Ali M, Cotton A, Westlake K (1999). *Down to earth: solid waste disposal for low-income countries*. WEDC, Loughborough.
- Cave B, Kolsky P (July 1999). *Groundwater, latrines and health*. WELL Study. WELL, London.
- Cotton A, Saywell D (1998). *On-plot sanitation in low income urban communities*. WEDC, Loughborough.
- Feachem R et al. (1983). *Sanitation and disease: health aspects of excreta and wastewater management*. John Wiley & Sons, Chichester.
- Franceys R, Pickford J, Reed RA (1992). *A guide to the development of on-site sanitation*. WHO, Geneva.
- Harvey P, Baghri S, Reed RA (2002). *Emergency sanitation: assessment and programme design*. WEDC, Loughborough.
- Hausman B (1994). *Guidelines for epidemics: cholera*. MSF, Amsterdam.
- Lacarin C, Reed RA (1999). *Emergency vector control using chemicals* WEDC, Loughborough.
- PAHO (1982). *Environmental health management after natural disasters*. Scientific Publication 430. PAHO, Washington, DC.
- PAHO (2002) *Tecnologías Apropriadadas en Agua Potable y Saneamiento Básico (Appropriate drinking water and sanitation technonolgies)*. PAHO, Washington, DC.
- Pickford J (1995). *Low-cost sanitation: a survey of practical experience*. IT Publications, London.
- Prüss A, Giroult E, Rushbrook P, eds. (1999). *Safe management of health-care wastes*. WHO, Geneva.
- Rottier E, Ince M (2003). *Controlling and preventing disease: the role of water and environmental sanitation interventions*. WEDC, Loughborough.
- Simpson-Hebert M, Wood S (1998). *Sanitation Promotion*. WSSCC working group on sanitation promotion. WHO, Geneva.

- UNHCR (1997). *Vector and pest control in refugee situations*. UNHCR, Geneva.
- UNICEF (1998). *A manual on school sanitation and hygiene*. Water, Environment and Sanitation Technical Series - No. 5. UNICEF, New York, NY.
- UNICEF (1998). *A sanitation handbook*. Water, Environment and Sanitation Technical Series - No. 3. UNICEF, New York, NY.
- WHO (1993). *Guidelines for cholera control*. WHO, Geneva.
- Winblad U, Kilaba W (1988). *Sanitation without water*. Macmillan, London & Basingstoke.

## Hygiene promotion and community management

- Almedom AM, Blumenthal U, Manderson L (1997). *Hygiene evaluation procedures: approaches and methods for assessing water- and sanitation-related hygiene practices*. International Nutrition Foundation for Developing Countries, Boston, MS / IT Publications, London..
- Benenson, AS, ed. (1995). *Control of communicable diseases in man*. 16<sup>th</sup> ed. American Public Health Association, Washington, DC.
- Cairncross S, Kochar VJ (1994). *Studying hygiene behaviour: methods, issues and experiences*. Sage Publications, London.
- Ferron S, Morgan J, O'Reilly M (2000). *Hygiene promotion, a practical manual for relief and development*. IT Publications/CARE International, London.
- Hubley J (1993). *Communicating health*. Macmillan, London & Basingstoke.
- Narayan D (1993). *Participatory evaluation: tools for managing change in water and sanitation*. World Bank, Washington, DC.
- Srinivasan L (1990). *Tools for community participation: a manual for training trainers in participatory techniques*. PROWESS/UNDP, New York, NY.
- UNICEF and The London School of Hygiene and Tropical Medicine (1999). *A manual on communication for water supply and environmental sanitation programmes*. Water, Environment and Sanitation Technical Series - No. 6. UNICEF
- van Wijk C, Murre T (1995). *Motivating better hygiene behaviour: importance for public health mechanisms of change*. IRC International Water and Sanitation Centre, The Hague.

## Specific interventions

- Adams J (1999). *Managing water supply and sanitation in Emergencies*. OXFAM, Oxford.
- Delmas G, Courvallet M (1994). *Public health engineering in emergency situation*. MSF, Paris.
- MSF (2004) *Clinical guidelines* Sixth edition
- OCHA (1999). *Orientation handbook on complex emergencies*. OCHA, New York, NY.
- Smout I, Parry-Jones S (1999) *Lessons learned from NGO experiences*. WELL, London.
- Telford J (1997). *Counting and identification of beneficiary populations in emergency operations: registration and its alternatives*. Good Practice Review 5. Relief and Rehabilitation Network/Overseas Development Institute, London.
- UNHCR (1992). *Water manual for refugee situations*. UNHCR, Geneva.
- UNHCR (1999). *Handbook for emergencies*. 2<sup>nd</sup> ed. UNHCR, Geneva.

# Websites

## Information

### General

<http://www.reliefweb.int/>

ReliefWeb is the global hub for time-critical humanitarian information on Complex Emergencies and Natural Disasters.

<http://www.unicef.org/wes/mdgreport/>

Millennium Development Goals.

<http://www.wssinfo.org/>

Joint Monitoring Programme (JMP) for water supply and sanitation. UNICEF and WHO.

The web-site information is both general and specific in nature, and provides a picture of the state of water supply and sanitation at different scales (global, regional and country), which enables you to “zoom” in and out. Information is presented in the form of short texts linked to tables, graphs and maps.

<http://www.dev-zone.org/>

Check Knowledge Centre: A comprehensive collection categorised by development themes, the Dev-Zone Knowledge Centre has over 8017 online resources including links to websites, organisations, articles, reports, resources etc.

<http://www.humanitarianinfo.org/>

Humanitarian Information Centers (HIC) support the co-ordination of humanitarian assistance through the provision of information products and services.

<http://worldwaterday.org>

There is basic information available both from the United Nations and from IRC International Water and Sanitation Centre. News, events and more.

### Technical

<http://www.worldwater.org/>

The World's Water. Information on the World's Fresh Water Resources, Water data, Books, Water links, Water conflict chronology.

<http://www.childinfo.org/eddb/water.htm>

UNICEF Water and Sanitation Databases.

<http://www.gemswater.org/>

The United Nations GEMS/Water Programme provides scientifically-sound data and information on the state and trends of global inland water quality required as a basis for the sustainable management of the world's freshwater to support global environmental assessments and decision-making processes.

<http://www.inweh.unu.edu/inweh/maps.htm>

Maps. GIS.

<http://www.thehydrogeologist.com/>

Organisations and Institutes, Geospatial data resources, software, Field and laboratory, Weather and climate data, Earth science studies.

## Water management

<http://www.undp.org/water/>

UNDP Water and Sanitation Site

Effective Water Governance, UNDP and the Millennium Development Goals. Community Water Initiative. Water Resource Management. Transboundary Waters. Ocean & Coastal Management. Water and Climate Change. Water Supply. Ecological Sanitation. Capacity Building. Gender Mainstreaming.

<http://www.oieau.fr/>

Office International de l'eau.

Capacity building for better water management.

French, English, Spanish, Portuguese.

## Water policies

<http://www.worldwatercouncil.org/>

The international water policy think tank.

<http://www.internationalwaterlaw.org/>

International Water Law Project.

<http://gwpforum.netmasters05.netmasters.nl/en/index.html>

Integrated Water Resources Management. Laws.

## Program development

<http://www.sphereproject.org/>

Humanitarian Charter and Minimum Standards in Disaster Response

<http://www.iaia.org/>

International Association for Impact Assessment.

[http://www.adb.org/Documents/Guidelines/Logical\\_Framework/](http://www.adb.org/Documents/Guidelines/Logical_Framework/)

Using the Logical Framework for Sector Analysis and Project Design: A User's Guide.

## Water and sanitation general links

### General

World Bank water and sanitation site

<http://www.worldbank.org/watsan/>

Rural Water Supply and Sanitation, Urban Water Supply and Sanitation.



<http://www.irc.nl/>

IRC International Water and Sanitation Centre.

News and information, advice, research and training, on low-cost water supply and sanitation in developing countries.

<http://www.oneworld.net/guides/water/>

Water and Sanitation guide.

Safe Sanitation, Clean Water, Water and MDGs, Demand Management, Water Scarcity, Water and Climate Change, Rainwater Harvesting, Water and War, Water and Privatisation.

## Technical

<http://wedc.lboro.ac.uk/>

Water, Engineering and Development Centre (WEDC).

Emergency water supply and sanitation, Enterprise development, Environment and health, Hydro-informatics, Institutional development, Knowledge management, Solid waste management, Transport, Urban services, Water and sanitation.

<http://www.lboro.ac.uk/well/>

DFID Water and Sanitation Web. Technical Enquiry Service - up to one day of free advice. Document Service - free of charge hard copy publications. Images - from the WEDC Image Library. Consultancy services available to DFID.

<http://www.cepis.ops-oms.org/>

Site in Spanish on everything concerning water and sanitation.

[http://www.who.int/water\\_sanitation\\_health/](http://www.who.int/water_sanitation_health/)

WHO. Water and Sanitation Site.

<http://www.thewaterpage.com/>

Water related documents.

## Sanitation

<http://www.sanicon.net/>

Sanitation connection. Everything about sanitation.

## Disaster reduction

<http://www.unisdr.org/>

International Strategy for Disaster Reduction.

[http://www.crid.or.cr/crid/CD\\_Educacion/](http://www.crid.or.cr/crid/CD_Educacion/)

Education for disaster reduction (Spanish).

<http://www.undmtp.org/links.htm>

UN Disaster Management Training Programme. Useful Internet Sites on Disaster and Emergency Management.

<http://www.disaster-info.net/>

DisasterInfo is the front page to a collection of mirror sites and/or direct access to web sites of many disaster organisations, particularly in Latin America and the Caribbean.



## Digital libraries

<http://www.sadl.uleth.ca/>

Check humanitarian and UN collections. i.e: Community Development Library: 1 785 publications (160 000 pages) in various areas of community development.

<http://www.dev-zone.org/>

Navigate in: knowledge/Knowledge\_and\_Information/Reference/Library\_Catalogues/

[http://www.lifewater.org/resources/tech\\_library.html](http://www.lifewater.org/resources/tech_library.html)

Collection of documents related to water supply, hygiene and sanitation.

<http://humaninfo.org/>

The objective of Humanitarian Information for All is to provide all persons involved in development, well-being and basic needs, access to a complete library containing most solutions, know-how and ideas they need to tackle poverty and increase human potential.

## Manuals

<http://www.lifewater.ca/manuals.htm>

Manuals about drilling, wells, pumps, water techniques, sanitation, public health.

## Education capacity building

<http://www.itdg.org/>

Intermediate Technology Development Group.  
Appropriate technologies.

<http://www.streams.net/>

Streams of Knowledge is a global coalition of Resource Centres in the water and sanitation field.

<http://www.la-wetnet.org/>

Latin-American network for education and capacity building in water-resources management.

<http://www.cap-net.org/>

Capacity Building for Integrated Water-Resources Management.

## Advocacy

<http://www.wsscc.org/>

Advocacy and Water and Sanitation.  
WASH - Water, Sanitation and Hygiene for All.

## Water resource glossary

<http://www.edwardsaquifer.net/glossary.html>

Glossary of Water Resource Terms

# Addresses

## Action contre la Faim

Alvaro de Vicente  
Responsable Eau et Assainissement  
4 rue Niepce  
75662 Paris Cedex 14  
FRANCE  
Phone. 01 43 35 88 12  
Fax 01 43 35 48 79  
Email [adevicente@actioncontrelafaim.org](mailto:adevicente@actioncontrelafaim.org)  
[www.actioncontrelafaim.org](http://www.actioncontrelafaim.org)

## Action against Hunger

Unit 7B  
Larnaca Works  
Grange Walk  
Bermondsey  
London SE1 JEW  
UNITED KINGDOM  
Phone 00 44 207 394 63 00  
Fax 00 44 207 237  
Email [info@aahuk.org](mailto:info@aahuk.org)

## Action against Hunger

247 W. 37th Street  
Suite 1201  
New York NY 10018  
UNITED STATES  
Phone 001 212 967 78 00  
Fax 001 212 967 5480  
Email [aah@aah-usa.org](mailto:aah@aah-usa.org)

## Acción contra el Hambre

Calle Caracas, 6 – 1°  
28010 Madrid  
SPAIN  
Phone 34 91 391 53 00  
Fax 34 91 391 53 01  
Email [ach@achesp.org](mailto:ach@achesp.org)

*Imprimé en France*  
*Imprimerie Barnéoud*  
*53960 Bonchamp-lès-Laval*  
*Numéro d'impression : 🍏🍏🍏*  
*Numéro d'édition :*  
*Dépôt légal : avril 2005*

HERMANN, ÉDITEURS DES SCIENCES ET DES ARTS